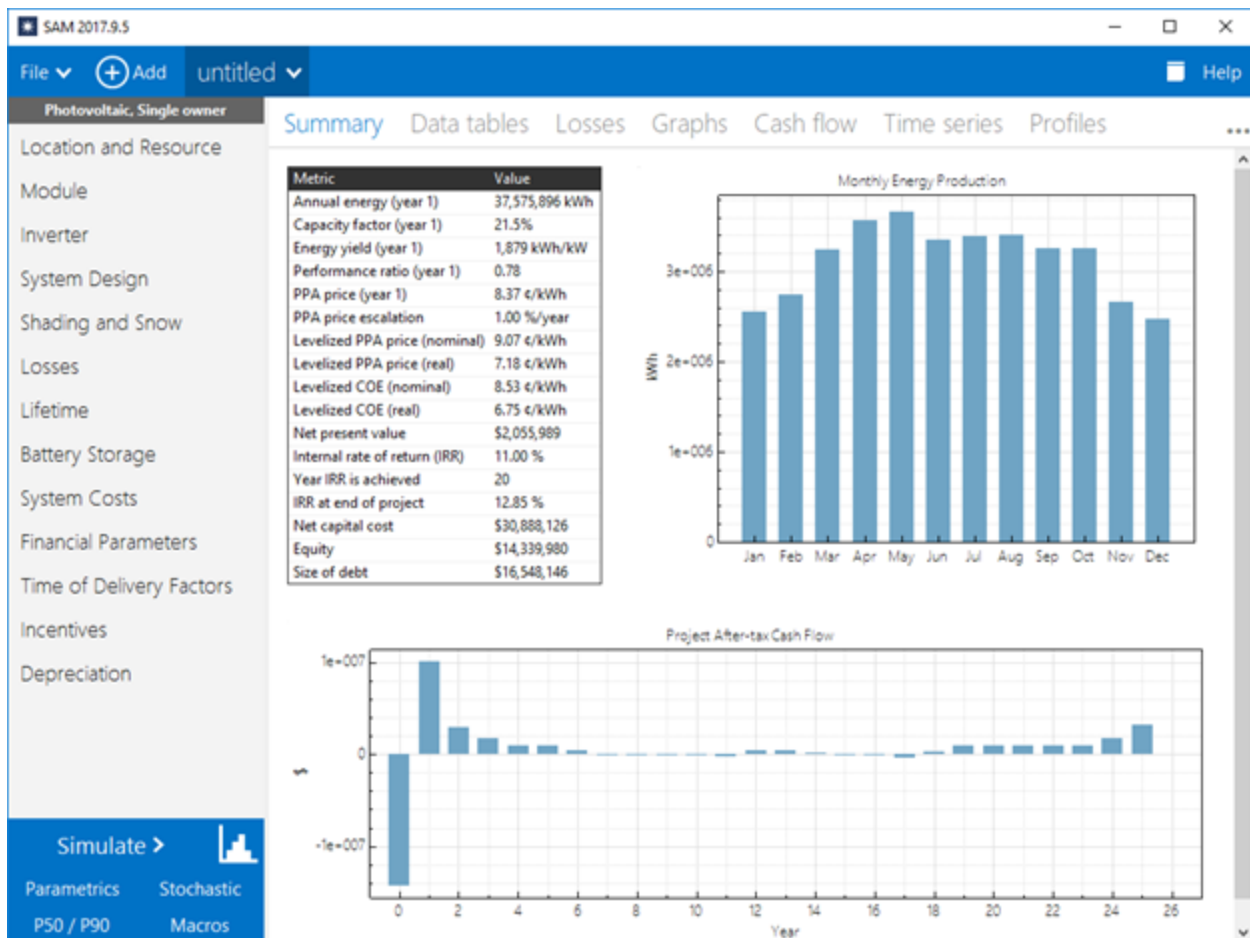


# System Advisor Model (SAM)

This document is a copy of SAM's Help system.

To see the Help system in SAM, click Help in the main window, or press the F1 key (command-? in MacOS) from any page in SAM.



SAM Version 2020.11.29  
Manual Release Date 12/4/2020

---

**© 2020 National Renewable Energy Laboratory**

The System Advisor Model ("Model") is provided by the National Renewable Energy Laboratory ("NREL"), which is operated by the Alliance for Sustainable Energy, LLC ("Alliance") for the U.S. Department Of Energy ("DOE") and may be used for any purpose whatsoever.

The names DOE/NREL/ALLIANCE shall not be used in any representation, advertising, publicity or other manner whatsoever to endorse or promote any entity that adopts or uses the Model. DOE/NREL/ALLIANCE shall not provide any support, consulting, training or assistance of any kind with regard to the use of the Model or any updates, revisions or new versions of the Model.

You agree to indemnify DOE/NREL/Alliance, and its affiliates, officers, agents, and employees against any claim or demand, including reasonable attorneys' fees, related to your use, reliance, or adoption of the model for any purpose whatsoever. The model is provided by DOE/NREL/Alliance "as is" and any express or implied warranties, including but not limited to the implied warranties of merchantability and fitness for a particular purpose are expressly disclaimed. In no event shall DOE/NREL/Alliance be liable for any special, indirect or consequential damages or any damages whatsoever, including but not limited to claims associated with the loss of data or profits, which may result from any action in contract, negligence or other tortious claim that arises out of or in connection with the use or performance of the model.

Microsoft and Excel are registered trademarks of the Microsoft Corporation.

While every precaution has been taken in the preparation of this document, the publisher and the author assume no responsibility for errors or omissions, or for damages resulting from the use of information contained in this document or from the use of programs and source code that may accompany it. In no event shall the publisher and the author be liable for any loss of profit or any other commercial damage caused or alleged to have been caused directly or indirectly by this document.

Produced: December 2020

# Table of Contents

<b>1</b>	<b>Introduction</b>	<b>12</b>
1.1	Performance Models.....	22
1.2	Financial Models.....	26
1.3	User Support.....	29
1.4	SAM Versions.....	30
1.5	Models and Databases.....	31
<b>2</b>	<b>Getting Started</b>	<b>34</b>
2.1	Welcome Page.....	36
2.2	Create a Project.....	38
2.3	Choose Models.....	39
2.4	Main Window.....	41
2.5	Input Pages.....	42
2.6	System Costs.....	45
2.7	Financial Model Inputs.....	46
2.8	Run Simulation.....	47
2.9	Results .....	48
2.10	Videos .....	49
<b>3</b>	<b>Reference</b>	<b>50</b>
3.1	File Menu.....	50
3.2	Case Menu.....	51
3.3	Manage Cases.....	52
3.4	Export Data and Graphs.....	55
3.5	Reports.....	57
3.6	Inputs Browser.....	59
3.7	Time Series Data Viewer.....	61
3.8	Weekday-weekend Schedule.....	63
3.9	Notes .....	65
3.10	Excel Exchange.....	66
3.11	Libraries.....	70
3.12	Macros and Scripting.....	73
3.13	Software Development Kit.....	77
3.14	File Formats.....	78

<b>SAM Help: Reference</b>	<b>Software Installation</b>	<b>4</b>
3.15	Software Installation.....	79
3.16	Registration.....	80
3.17	Web Access and Proxies.....	83
3.18	Keyboard Shortcuts.....	85
<b>4</b>	<b>Window Reference</b>	<b>86</b>
4.1	Edit Array.....	86
4.2	Edit Lifetime Data.....	87
4.3	Edit Losses.....	89
4.4	Edit Monthly Data.....	90
4.5	Edit Data Table by Column.....	91
4.6	Edit Data Table by Row.....	93
4.7	Edit Parametric Values.....	94
4.8	Parametric Quick Setup.....	96
4.9	NSRDB Advanced Download.....	97
4.10	WIND Toolkit Download.....	100
<b>5</b>	<b>Simulation</b>	<b>101</b>
5.1	Parametric Simulations.....	101
5.2	Stochastic Simulations.....	108
5.3	P50/P90 Simulations.....	109
5.4	Optimization.....	110
<b>6</b>	<b>Weather Data</b>	<b>111</b>
6.1	Folders and Libraries.....	111
6.2	Weather Data Elements.....	114
6.3	Typical and Single Year.....	116
6.4	Time and Sun Position.....	117
6.5	Weather Data and LK.....	118
<b>7</b>	<b>Weather File Formats</b>	<b>119</b>
7.1	SAM CSV Format for Solar.....	120
7.2	SRW Format for Wind.....	125
7.3	CSV Format for Marine Energy.....	127
<b>8</b>	<b>Photovoltaic Systems</b>	<b>130</b>
8.1	Location and Resource.....	133
8.2	PV System Costs.....	146



8.3	Edit Shading Data.....	151
8.4	PV Sizing and Configuration.....	158
8.5	Microinverters.....	166
8.6	Detailed Photovoltaic Model.....	168
	Module.....	171
	Inverter.....	192
	System Design.....	207
	Shading and Layout.....	216
	Losses.....	222
	Results.....	225
8.7	PVWatts.....	230
	System Design.....	232
	Results.....	241
8.8	Concentrating Photovoltaic.....	241
	Module.....	243
	Inverter.....	245
	Array.....	247
	System Costs.....	251
	Results.....	256
<b>9</b>	<b>Battery Storage</b>	<b>257</b>
9.1	Behind the Meter (BTM).....	258
9.2	Battery Dispatch BTM.....	274
9.3	Front of Meter (FOM).....	278
9.4	Battery Dispatch FOM.....	294
9.5	Results.....	298
<b>10</b>	<b>Wind</b>	<b>300</b>
10.1	Wind Resource.....	303
10.2	Wind Turbine.....	310
10.3	Wind Farm.....	312
10.4	Losses.....	315
10.5	Uncertainties.....	316
10.6	System Costs.....	316
<b>11</b>	<b>Marine Energy Wave</b>	<b>321</b>
11.1	Wave Resource.....	322

---

11.2	Wave Energy Converter.....	324
11.3	Array .....	326
11.4	Losses.....	327
11.5	Capital and O&M Costs.....	328
<b>12</b>	<b>Marine Energy Tidal</b>	<b>330</b>
12.1	Tidal Resource.....	331
12.2	Tidal Energy Converter.....	332
12.3	Array .....	333
12.4	Losses.....	335
12.5	Capital and O&M Costs.....	335
<b>13</b>	<b>Geothermal</b>	<b>338</b>
13.1	Ambient Conditions.....	338
13.2	Geothermal Resource.....	339
13.3	Plant and Equipment.....	340
13.4	Power Block.....	342
13.5	System Costs.....	345
<b>14</b>	<b>Solar Water Heating</b>	<b>347</b>
14.1	Location and Resource.....	350
14.2	Solar Water Heating.....	360
14.3	System Costs.....	366
14.4	Results.....	371
<b>15</b>	<b>Fuel Cell</b>	<b>373</b>
15.1	PV System.....	375
15.2	Fuel Cell.....	382
15.3	Dispatch.....	387
15.4	System Costs.....	393
<b>16</b>	<b>Biomass Combustion</b>	<b>396</b>
16.1	Ambient Conditions.....	396
16.2	Feedstock.....	405
16.3	Plant Specs.....	408
16.4	Emissions.....	414
16.5	System Costs.....	416
16.6	Feedstock Costs.....	419

<b>17 Generic System</b>	<b>419</b>
17.1 Power Plant.....	420
17.2 System Costs.....	424
<b>18 CSP Parabolic Trough</b>	<b>428</b>
18.1 Location and Resource.....	428
18.2 System Costs.....	437
18.3 Solar Multiple.....	443
18.4 Custom HTF.....	447
18.5 Physical Trough Model.....	448
System Design.....	449
Solar Field.....	451
Collectors (SCAs).....	462
Receivers (HCEs).....	465
Power Cycle.....	468
Thermal Storage.....	475
System Control.....	479
Script-only Parameters.....	487
18.6 Empirical Trough Model.....	492
Solar Field.....	493
Collectors (SCAs).....	499
Receivers (HCEs).....	501
Power Block.....	504
Thermal Storage.....	512
Parasitics.....	518
<b>19 CSP Power Tower</b>	<b>521</b>
19.1 Location and Resource.....	521
19.2 System Design.....	531
19.3 Heliostat Field.....	533
19.4 Heliostat Field Layout.....	547
19.5 Tower and Receiver.....	549
19.6 Power Cycle.....	554
19.7 Thermal Storage.....	561
19.8 System Control.....	563
19.9 System Costs.....	571

---

## **20 CSP Linear Fresnel** **577**

20.1	Location and Resource.....	578
20.2	System Costs.....	587
20.3	Direct Steam Linear Fresnel.....	593
	Solar Field.....	594
	Collector and Receiver.....	600
	Power Cycle.....	607
	Parasitics.....	614
20.4	Molten Salt Linear Fresnel.....	615
	Solar Field.....	615
	Collector and Receiver.....	623
	Power Cycle.....	630
	Thermal Storage.....	635
	Parasitics.....	642

## **21 CSP Generic Solar** **643**

21.1	Location and Resource.....	644
21.2	Solar Field.....	653
21.3	Power Block.....	657
21.4	Thermal Storage.....	660
21.5	System Costs.....	665

## **22 IPH Parabolic Trough** **668**

22.1	Location and Resource.....	668
22.2	System Design.....	677
22.3	Solar Field.....	680
22.4	Collectors (SCAs).....	687
22.5	Receivers (HCEs).....	690
22.6	Thermal Storage.....	694
22.7	System Control.....	695

## **23 IPH Linear Direct Steam** **703**

23.1	Location and Resource.....	703
23.2	System Design.....	712
23.3	Solar Field.....	714
23.4	Collector and Receiver.....	717

---

<b>24 Lifetime and Degradation</b>	<b>724</b>
<b>25 Grid Limits</b>	<b>727</b>
<b>26 Financial Parameters</b>	<b>728</b>
26.1 Residential.....	729
26.2 Commercial.....	733
26.3 Third Party - Host.....	737
26.4 Third Party - Host / Developer.....	739
26.5 Single Owner.....	749
26.6 Merchant Plant.....	757
26.7 Leveraged Partnership Flip.....	765
26.8 All Equity Partnership Flip.....	775
26.9 Sale Leaseback.....	783
26.10 LCOE Calculator.....	791
<b>27 Revenue</b>	<b>796</b>
27.1 Power Purchase Agreement.....	796
27.2 Merchant Plant.....	804
27.3 Time of Delivery Factors.....	806
<b>28 Incentives and Depreciation</b>	<b>810</b>
28.1 Incentives.....	811
28.2 Depreciation.....	817
<b>29 Electricity Rates and Load</b>	<b>820</b>
29.1 Electric Load.....	820
29.2 Electricity Rates.....	825
29.3 Electricity Bill Results.....	843
<b>30 Thermal Rates and Load</b>	<b>847</b>
30.1 Thermal Load.....	848
30.2 Thermal Rates.....	849
<b>31 Results</b>	<b>851</b>
31.1 Summary.....	851
31.2 Losses.....	854
31.3 Graphs.....	855

<b>SAM Help: Results Data Tables</b>	<b>10</b>
31.4 Data Tables.....	856
31.5 Cash Flow.....	859
31.6 Time Series.....	859
31.7 Profiles.....	861
31.8 Statistics.....	862
31.9 Heat Map.....	863
31.10 PDF / CDF.....	864
31.11 Uncertainties.....	865
31.12 Notices.....	866
<b>32 Financial Metrics</b>	<b>868</b>
32.1 Debt and Equity.....	871
32.2 Electricity Bill and Savings.....	872
32.3 Indifference Point.....	873
32.4 Internal Rate of Return (IRR).....	873
32.5 Levelized Cost of Energy (LCOE).....	874
32.6 Levelized PPA price.....	877
32.7 Net Present Value (NPV).....	879
32.8 Payback Period.....	879
32.9 PPA Price.....	882
32.10 PPA Price Escalation.....	882
32.11 Net Capital Cost.....	883
<b>33 Performance Metrics</b>	<b>884</b>
33.1 Annual Biomass Usage.....	886
33.2 Annual Energy.....	887
33.3 Annual Water Usage.....	887
33.4 Aux with and without Solar (kWh).....	888
33.5 Capacity Factor.....	888
33.6 Energy Yield.....	889
33.7 Gross to Net Conv Factor.....	890
33.8 Heat Rate and Thermal Efficiency.....	890
33.9 Pump Power.....	890
33.10 Solar Fraction.....	891
33.11 Performance Ratio.....	891
<b>34 Cash Flow Details</b>	<b>892</b>

<b>SAM Help: Cash Flow Details Residential and Commercial</b>	<b>11</b>
34.1 Residential and Commercial.....	892
34.2 Single Owner.....	907
34.3 All Equity Partnership Flip.....	926
34.4 Leveraged Partnership Flip.....	951
34.5 Sale Leaseback.....	976
<b>35 3D Shade Calculator</b>	<b>996</b>
35.1 How-To.....	997
Define the scene location.....	998
Use an image underlay.....	998
Add shading objects.....	999
Add active surface objects.....	1000
Change the view.....	1001
Zoom and pan the scene.....	1002
Select an object.....	1003
Move objects.....	1004
Resize objects.....	1005
Rotate objects.....	1006
Delete and copy objects.....	1007
Change object colors.....	1008
Generate shade data.....	1008
Export shade data.....	1010
35.2 Reference.....	1010
Shade data description.....	1011
Location.....	1011
Active surfaces.....	1012
Shading objects.....	1014
3D scene view.....	1017
Bird's eye view.....	1018
Elevations view.....	1019
Analyze.....	1020
Import and Export.....	1021
Save and Close.....	1021
Shortcuts.....	1021
File Types.....	1022

# 1 Introduction

The System Advisor Model (SAM) is a performance and financial model designed to facilitate decision making for people involved in the renewable energy industry:

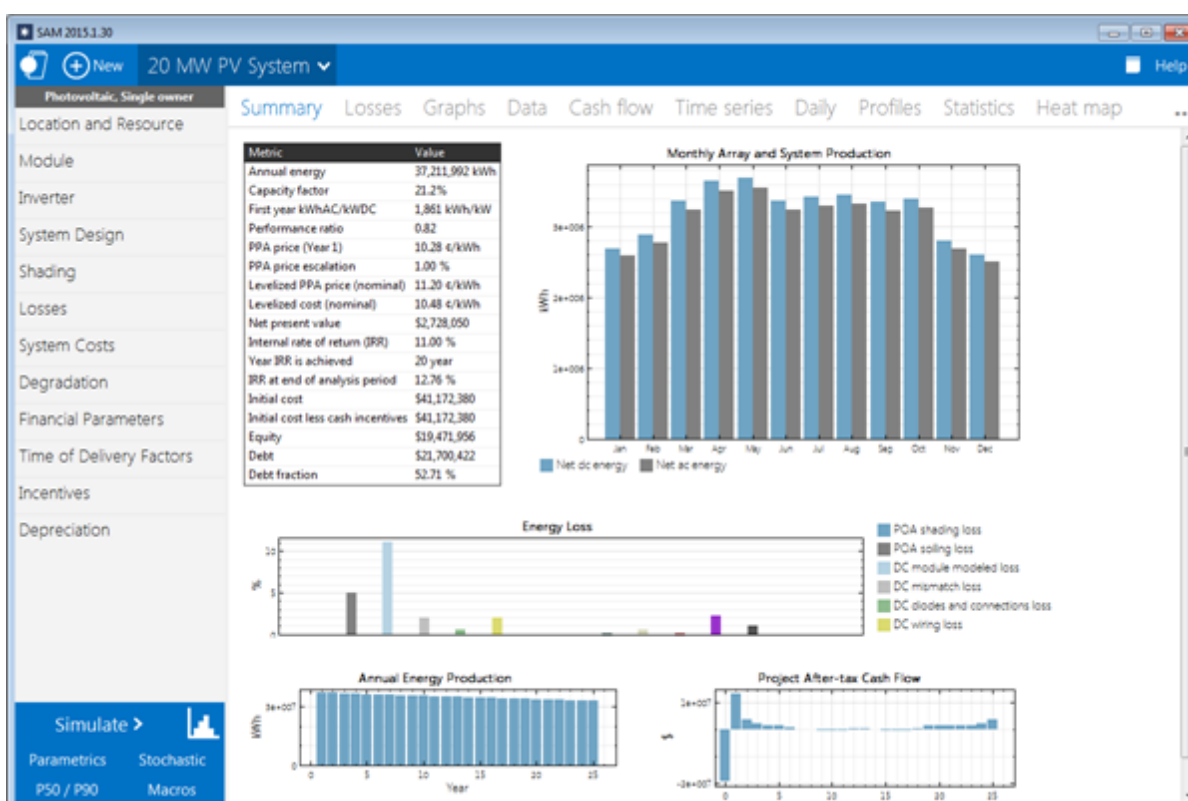
- Project managers and engineers
- Policy analysts
- Technology developers
- Researchers

SAM makes performance predictions and cost of energy estimates for grid-connected power projects based on installation and operating costs and system design parameters that you specify as inputs to the model.

Projects can be either on the customer side of the utility meter, buying and selling electricity at retail rates, or on the utility side of the meter, selling electricity at a price negotiated through a power purchase agreement (PPA).

For videos demonstrating how to use SAM for different kinds of projects, see the [SAM website](#).

The following image shows SAM's main window showing monthly electricity generation and the annual cash flow for a photovoltaic system.





The first step in creating a SAM file is to choose a performance and financial model for your project. SAM automatically populates input variables with a set of default values for the type of project. It is your responsibility as an analyst to review and modify all of the input data as appropriate for each analysis.

Next, you provide information about a project's location, the type of equipment in the system, the cost of installing and operating the system, and financial and incentives assumptions.

## SAM Models and Databases

SAM represents the cost and performance of renewable energy projects using computer models developed at NREL, Sandia National Laboratories, the University of Wisconsin, and other organizations. Each performance model represents a part of the system, and each financial model represents a project's financial structure. The models require input data to describe the performance characteristics of physical equipment in the system and project costs. SAM's user interface makes it possible for people with no experience developing computer models to build a model of a renewable energy project, and to make cost and performance projections based on model results.

SAM requires a weather file describing the renewable energy resource and weather conditions at the project location. Depending on the kind of system you are modeling, you either choose a resource data file from a list, download one from the internet, or create the file using your own data.

SAM can automatically download data from the following online databases:

- [OpenEI U.S. Utility Rate Database](#) for retail electricity rate structures for U.S. utilities
- [NREL National Solar Radiation Database](#) for solar resource data and ambient weather conditions.
- [NREL WIND Toolkit](#) for wind resource data.

SAM includes several databases of performance data and coefficients for system components such as photovoltaic modules and inverters, parabolic trough receivers and collectors, wind turbines, or biopower combustion systems. For those components, you simply choose an option from a list.

For the remaining input variables, you either use the default value or change its value. Some examples of input variables are:

- Installation costs including equipment purchases, labor, engineering and other project costs, land costs, and operation and maintenance costs.
- Numbers of modules and inverters, tracking type, derating factors for photovoltaic systems.
- Collector and receiver type, solar multiple, storage capacity, power block capacity for parabolic trough systems.
- Analysis period, real discount rate, inflation rate, tax rates, internal rate of return target or power purchase price for PPA financial models.
- Building load and time-of-use retail rates for commercial and residential financial models.
- Tax and cash incentive amounts and rates.

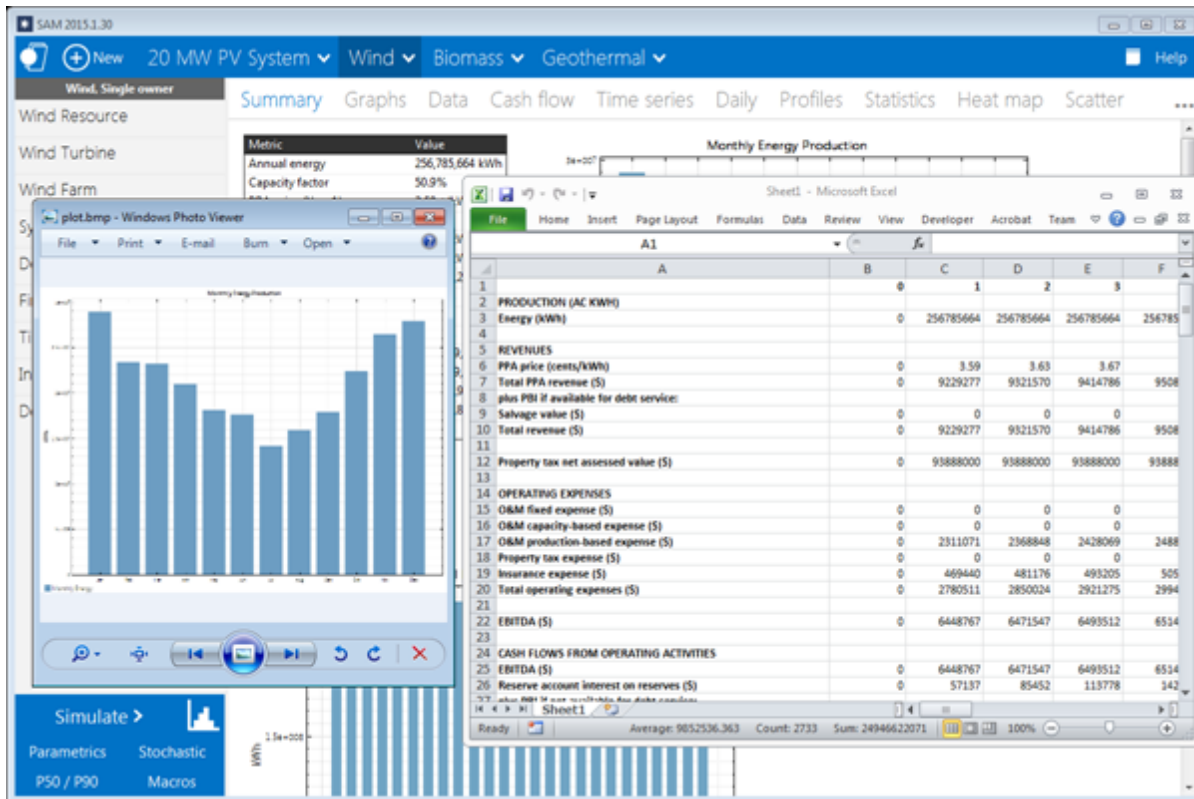
Once you are satisfied with the input variable values, you run a simulation, and then examine results. A typical analysis involves running simulations, examining results, revising inputs, and repeating that process until you understand and have confidence in the results.

## Results: Tables, Graphs, and Reports

SAM displays simulation results in tables and graphs, ranging from the metrics table displaying the project's net present value (NPV), first year annual production, and other single-value metrics, to the detailed annual cash flow and hourly performance data that can be viewed in tabular or graphical form.

A built-in graphing tool displays a set of default graphs and allows for creation of custom graphs. All graphs and tables can be exported in various formats for inclusion in reports and presentations, and also for further analysis with spreadsheet or other software.

The Results page displays graphs of results that you can easily export to your documents:



SAM's report generator allows you to create custom reports to include SAM results in your project proposals and other documents:

20 MW PV System.pdf - Adobe Acrobat

File Edit View Window Help

**System Advisor Model Report**

Photovoltaic System 20.0 DC MW Nameplate Phoenix, AZ  
 Single Owner \$1.90W Installed Cost 33.43 N, -112.02 E GMT -7

Performance Model		Financial Model	
<b>Modules</b>		<b>Project Costs</b>	
SunPower SPR-305-48P-U		Total installed cost	\$18,948,278
Cell material	Mono-Si	Salvage value	80
Module area	1.6 m <sup>2</sup>	<b>Analysis Parameters</b>	
Module capacity	333.2 DC Watts	Project life	25 years
Quantity	65,520	Inflation rate	2.5%
Total capacity	20 DC MW	Risk discount rate	1.5%
Total area	106,863 m <sup>2</sup>	<b>Financial Targets and Constraints</b>	
<b>Inverters</b>		Solution mode	
Advanced Energy Solaron 333-2158000-10X 480V		Calculate PPA Price	
Unit capacity	333 AC kW	Target IRR	11% in Year 20
Input voltage	330-600 VDC DC V	PPA escalation rate	1%/year
Quantity	55	<b>Project Debt Parameters</b>	
Total capacity	18.3 AC MW	Debt fraction	62.71%
DC to AC Capacity Ratio	1.09	Amount	\$25,454,202
AC losses (%)	1.0	Term	18 years
<b>Arrays</b>		Rate	7%
Strings	8,190	<b>Tax and Insurance Rates (% of installed cost)</b>	
Modules per string	8	Federal income tax	35%/year
String voltage (DC V)	0.0	State income tax	7%/year
Tilt (deg from horizontal)	33	Sales tax	0%
Azimuth (deg E of N)	180	Insurance	0.5%/year
Tracking	fixed	Property tax (% of assess. val.)	0%/year
Backtracking	-	<b>Incentives</b>	
Rotation limit (deg)	-	Federal ITC	30%
Shading	no	Depreciation	Depreciation allocations defined with no bonus depreciation
Sizing	yes	<b>Results</b>	
DC losses (%)	4.4	Nominal LCOE	10.5 cents/kWh
<b>Performance Adjustment</b>		PPA price (year one)	10.3 cents/kWh
Annual	no	Project IRR	11% in Year 20
Year-to-year decline	0.5	Project NPV	\$2,728,000
Involuntary factors	yes		
<b>Annual Results (in Year 1)</b>			
DC kWh/day	5.8		
POA kWh/m <sup>2</sup> /day	6.0		
DC kWh from array	40.5		
Net to inverter	38,895,000 DC kWh		
Gross from inverter	37,587,000 AC kWh		
Net to grid	37,211,000 AC kWh		
Capacity factor	21.24		
Performance ratio	0.82		

Single Owner | Flat Rate PPA | Simple Efficiency Module Model | Simple Inverter Database

System Advisor Model Standard Report generated by SAM 2010.1.30 on Thu Jan 20 13:04:23 2010 1/3

## Performance Models

SAM's performance models make hour-by-hour calculations of a power system's electric output, generating a set of 8,760 hourly values that represent the system's electricity production over a single year. Some performance models also support subhourly simulations. You can explore the system's performance characteristics in detail by viewing tables and graphs of the hourly and monthly performance data, or use performance metrics such as the system's total annual output and capacity factor for more general performance evaluations.

The Time Series graph on the Results page showing hourly electricity generation for a 100 MW parabolic trough system with 6 hours of storage in Tuscon, Arizona:



The current version of the SAM includes performance models for the following types of systems:

- Photovoltaic systems (flat-plate and concentrating)
- Battery storage
- Parabolic trough concentrating solar power
- Power tower concentrating solar power (molten salt)
- Linear Fresnel concentrating solar power (heat transfer fluid and direct steam)
- Industrial process heat models for parabolic troughs and linear collectors
- Conventional fossil-fuel thermal
- Solar water heating for residential or commercial buildings
- Wind power (large and small)
- Marine energy
- Geothermal power
- Biomass combustion

## Financial Models

SAM's financial models calculate financial metrics for various kinds of power projects based on a project's cash flows over an analysis period that you specify. The financial models use the system's electrical output calculated by the performance model to calculate the series of annual cash flows.

SAM includes financial models for the following kinds of projects:

- Residential (retail electricity rates)
- Commercial (retail rates)

- Third party ownership (retail rates and power purchase agreement)
- Power purchase agreement, PPA (utility-scale or power generation project)
  - Single owner
  - Leveraged partnership flip
  - All equity partnership flip
  - Sale leaseback
- Merchant plant

## Residential and Commercial Projects

Residential and commercial projects are financed through either a loan or cash payment, and recover investment costs by selling electricity through either a net metering or time-of-use pricing agreement. For these projects, SAM reports the following financial metrics in addition to a detailed annual cash flow:

- Levelized cost of energy (LCOE)
- Electricity bill with and without the power system
- After-tax net present value (NPV)
- Payback Period

## Power Purchase Agreement (PPA) Projects

PPA projects are assumed to sell electricity through a power purchase agreement at a fixed price with optional annual escalation and time-of-delivery (TOD) factors. For these projects, SAM calculates a detailed annual cash flow and the following metrics:

- Levelized cost of energy (LCOE)
- PPA price (electricity sales price)
- Internal rate of return
- Net present value (NPV)
- Debt percent or debt service coverage ratio

SAM can either calculate the internal rate of return based on a power price you specify, or calculate the power price based on the rate of return you specify.

## Project Cash Flow

SAM calculates financial metrics from project cash flows representing the value of energy savings for projects using retail electricity rates, and the value of revenue from electricity sales for projects selling electricity under a power purchase agreement. For the PPA partnership models, SAM calculates cash flows from the project perspective and from the perspective of each partner.

The following image shows several rows of the cash flow table for a PPA project:

	0	1	2	3	4	5	6	7
<b>PRODUCTION (AC KWH)</b>								
Energy (kWh)	0	256,785,664	256,785,664	256,785,664	256,785,664	256,785,664	256,785,664	256,785,664
<b>REVENUES</b>								
PPA price (cents/kWh)	0	3.59	3.63	3.67	3.70	3.74	3.78	3.82
Total PPA revenue (\$)	0	9,229,277	9,321,570	9,414,786	9,508,934	9,604,023	9,700,063	9,797,064
plus PBI if available for debt service:								
Salvage value (\$)	0	0	0	0	0	0	0	0
Total revenue (\$)	0	9,229,277	9,321,570	9,414,786	9,508,934	9,604,023	9,700,063	9,797,064
<b>OPERATING EXPENSES</b>								
O&M fixed expense (\$)	0	0	0	0	0	0	0	0
O&M capacity-based expense (\$)	0	0	0	0	0	0	0	0
O&M production-based expense (\$)	0	2,311,071	2,368,848	2,428,069	2,488,771	2,550,990	2,614,765	2,680,134
Property tax expense (\$)	0	0	0	0	0	0	0	0
Insurance expense (\$)	0	469,440	481,176	493,205	505,536	518,174	531,128	544,407
Total operating expenses (\$)	0	2,780,511	2,850,024	2,921,275	2,994,306	3,069,164	3,145,893	3,224,540
<b>EBITDA (\$)</b>	0	6,448,767	6,471,547	6,493,512	6,514,628	6,534,859	6,554,171	6,572,524

	% of Total Depreciable Basis	Gross Amount Allocated	IBI Reduction	CBI Reduction	Depreciable Basis Prior to ITC	ITC Qualifying Costs	% of ITC Qualifying Costs	ITC Amount	ITC Basis Disallowance	ITC Amount	ITC D
State Depreciation & ITC		90,467,832.00	0	0	90,467,832.00	90,467,832.00	100.00	0	0	0	0
5-yr MACRS	92.78	1,507,797.25	0	0	1,507,797.25	0	0	0	0	0	0
15-yr MACRS	1.55	0	0	0	0	0	0	0	0	0	0
5-yr Straight Line	0	0	0	0	0	0	0	0	0	0	0
15-yr Straight Line	2.58	2,512,995.50	0	0	2,512,995.50	0	0	0	0	0	0
20-yr Straight Line	3.09	3,015,594.50	0	0	3,015,594.50	0	0	0	0	0	0
39-yr Straight Line	0	0	0	0	0	0	0	0	0	0	0
Custom	0	0	0	0	0	0	0	0	0	0	0

The project annual cash flows include:

- Value of electricity sales (or savings) and incentive payments
- Installation costs
- Operating, maintenance, and equipment replacement costs
- Debt principal and interest payments
- Tax benefits and liabilities (accounting for any tax credits for which the project is eligible)
- Incentive payments
- Project and partner's internal rate of return requirements (for PPA projects)

## Incentives

The financial model can account for a wide range of incentive payments and tax credits:

- Investment based incentives (IBI)
- Capacity-based incentives (CBI)
- Production-based incentives (PBI)
- Investment tax credits (ITC)
- Production tax credits (PTC)
- Depreciation (MACRS, Straight-line, custom, bonus, etc.)

## Analysis Options

In addition to simulating a system's performance over a single year and calculating a project cash flow over a multi-year period, SAM's analysis options make it possible to conduct studies involving multiple

simulations, linking SAM inputs to a Microsoft Excel workbook, and working with custom simulation modules.

The following options are for analyses that investigate impacts of variations and uncertainty in assumptions about weather, performance, cost, and financial parameters on model results:

- **Parametric Analysis:** Assign multiple values to input variables to create graphs and tables showing the value of output metrics for each value of the input variable. Useful for optimization and exploring relationships between input variables and results.
- **Stochastic:** Assign multiple values to input variables using parameters for statistical distributions.
- **P50/P90:** For locations with weather data available for many years, calculate the probability that the system's total annual output will exceed a certain value.

Finally, SAM's scripting language LK allows you to write your own scripts within the SAM user interface to control simulations, change values of input variables, and write data to text files. SAM macros are LK scripts that come with the software and can be run with no knowledge of scripting. SAM macros include a weather file checker, multiple subsystems, photovoltaic system sizing assistant, and tornado plot generator.

SAM also makes it possible to work with external models developed in Excel with Excel Exchange, which allows Excel to calculate the value of input variables, and automatically pass values of input variables between SAM and Excel.

## Software Development History and Users

SAM, originally called the "Solar Advisor Model" was developed by the National Renewable Energy Laboratory in collaboration with Sandia National Laboratories in 2005, and at first used internally by the U.S. Department of Energy's Solar Energy Technologies Program for systems-based analysis of solar technology improvement opportunities within the program. The first public version was released in August 2007 as Version 1, making it possible for solar energy professionals to analyze photovoltaic systems and concentrating solar power parabolic trough systems in the same modeling platform using consistent financial assumptions. Since 2007, two new versions have been released each year, adding new technologies and financial models. In 2010, the name changed to "System Advisor Model" to reflect the addition of non-solar technologies.

The DOE, NREL, and Sandia continue to use the model for program planning and grant programs. Since the first public release, over 35,000 people representing manufacturers, project developers, academic researchers, and policy makers have downloaded the software. Manufacturers are using the model to evaluate the impact of efficiency improvements or cost reductions in their products on the cost of energy from installed systems. Project developers use SAM to evaluate different system configurations to maximize earnings from electricity sales. Policy makers and designers use the model to experiment with different incentive structures.

## Downloading SAM and User Support

SAM runs on both Windows and OS X. It requires about 500 MB of storage space on your computer.

SAM is available for free download at <http://sam.nrel.gov>.

To run SAM, you must register your copy of SAM by providing NREL with a valid email address.

SAM's website includes software descriptions, links to publications about SAM and other resources:

The screenshot shows the NREL System Advisor Model (SAM) website. At the top left is the NREL logo with the text 'NATIONAL RENEWABLE ENERGY LABORATORY'. To its right is the title 'System Advisor Model (SAM)'. In the top right corner, there are links for 'Login' and 'Register', and a search bar with a 'Search' button. Below the title is a dark blue navigation bar with the following menu items: HOME, DOWNLOAD, SDK (with a dropdown arrow), SUPPORT, RESOURCES (with a dropdown arrow), CONTACT, ACCOUNT, and ABOUT. The main content area is titled 'Download SAM' and includes a sub-header 'published by admin on Tue, 2011-08-30 08:47'. There are three download buttons: a blue button for 'Download SAM 2017.9.5 for Windows' (Windows 10/8/7, EXE 192 MB), an orange button for 'Download SAM 2017.9.5 for OS X' (OS X 10.9 Intel or later, DMG 212 MB), and a grey button for 'Download SAM 2017.9.5 for Linux' (Linux 64-bit, RUN 244 MB). To the right of these buttons is a 'Legacy Versions' section with the text 'Log on or Register to download legacy versions of SAM.' Below the download buttons, there is a paragraph of text: 'The current version of System Advisor Model is **SAM 2017.9.5**. It requires about 900 MB of disk space, and runs on Windows 10/8/7, OS X 10.9 or later, and Linux 64-bit operating systems. On Windows, SAM's installation program automatically installs both the 32-bit and 64-bit version on your computer, and the desktop and Start menu shortcuts point to the version of SAM that matches your computer's operating system. Only 64-bit versions are available for OSX and Linux.' Below this paragraph is another line of text: 'The first time you start SAM, you must provide a valid email address to request a free registration key that'.

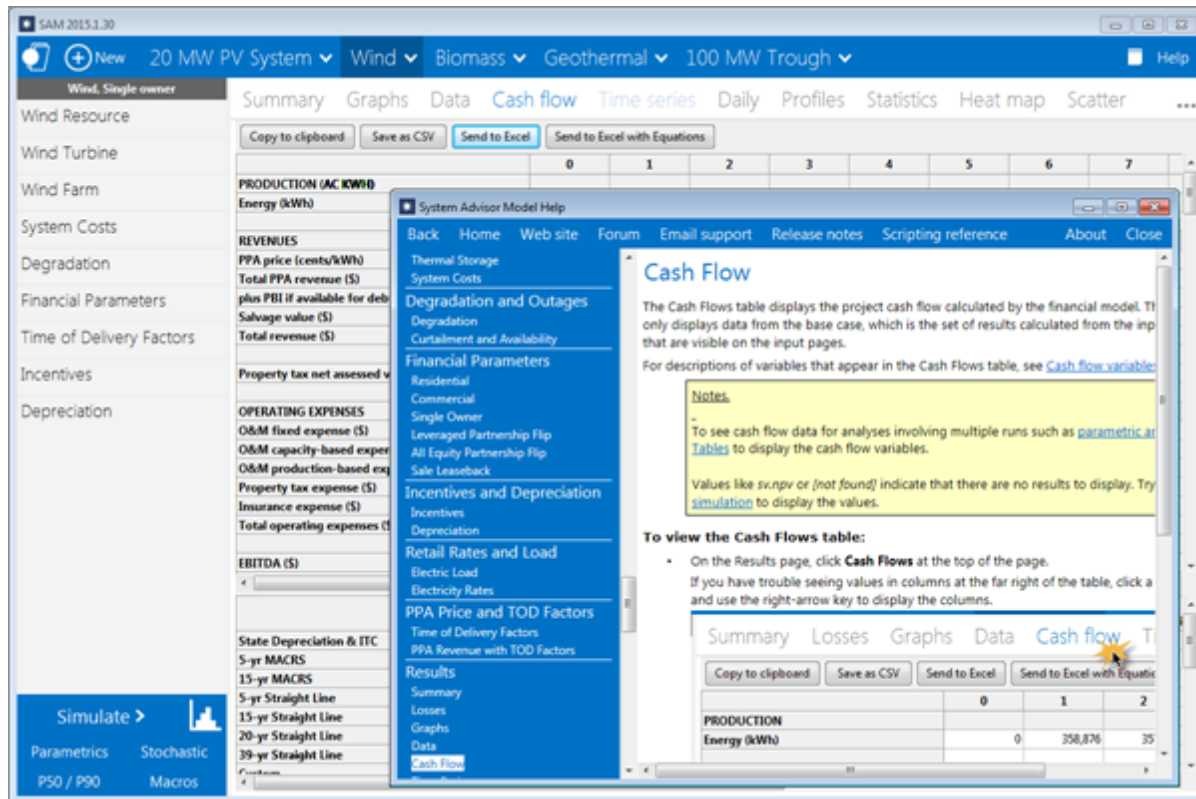
The following resources are available for learning to use SAM and for getting help with your analysis:

- The built-in Help system (also available on the website as a PDF from the Download page)
- User support forum: <https://sam.nrel.gov/forum>
- Webinars and demonstration videos: <https://sam.nrel.gov>

You can contact the SAM support team by emailing [sam.support@nrel.gov](mailto:sam.support@nrel.gov).

SAM's help system includes detailed descriptions of the user interface, modeling options, and results:





## Model Structure

SAM consists of a user interface, SAM Simulation Core (SSC), and an application programming interface (API). The user interface is the part of SAM that you see, and provides access to input variables and simulation controls, and displays tables and graphs of results. SSC performs a time-step-by-time-step simulation of a power system's performance, and financial calculations to generate a project cash flow and financial metrics. The API allows programs to interact with SSC. You can write software to interact with the API using the [software development kit \(SDK\)](#).

The user interface performs three basic functions:

- Provide access to input variables, which are organized into input pages. The input variables describe the physical characteristics of a system, and the cost and financial assumptions for a project.
- Allow you to control how SAM runs simulations. You can run a basic simulation, or more advanced simulations for optimization and sensitivity studies.
- Provide access to output variables in tables and graphs on the Results page, and in files that you can access in a spreadsheet program or graphical data viewer.

SAM's [scripting language](#), called LK, allows you to automate certain tasks. If you have some experience writing computer programs, you can easily learn to write LK scripts to set the values of input variables by reading them from a text file or based on calculations in the script, run simulations, and write values of results to a text file. You can also use LK to automatically run a series of simulations using different weather files.

[Excel Exchange](#) allows you to use Microsoft Excel to calculate values of input variables. With Excel Exchange, each time you run a simulation, SAM opens a spreadsheet and, depending on how you've

configured Excel Exchange, writes values from SAM input pages to the spreadsheet, and reads values from the spreadsheet to use in simulations. This makes it possible to use spreadsheet formulas to calculate values of SAM input variables.

Each renewable energy technology in SAM has a corresponding performance model that performs calculations specific to the technology. Similarly, each financial model in SAM is also associated with a particular financial model with its own set of inputs and outputs. The financial models are as independent as possible from the performance models to allow for consistency in financial calculations across the different technologies.

A performance simulation consists of a series of many calculations to emulate the performance of the system over a one year period in time steps of one hour for most simulations, and shorter time steps for some technologies.

A typical simulation run consists of the following steps:

1. After starting SAM, you select a combination of technology and financial models for a case in the user interface.
2. Behind the scenes, SAM chooses the proper set of simulation and financial models in SSC.
3. You specify values of input variables in the user interface. Each variable has a default value, so it is not necessary to specify a value for every variable.
4. When you click the Simulate button, SAM runs the SSC performance and financial models. For advanced analyses, you can configure simulations for [optimization](#) or [sensitivity analyses](#) before running a simulation.
5. SAM displays graphs and tables of [results](#) in the user interface.

## 1.1 Performance Models

SAM's performance models run hourly or subhourly simulations to calculate the power system's electrical output. The sum of these values is the total annual output that the [financial model](#) uses to calculate the project annual cash flows and financial metrics.

### Notes.

The solar water heating models calculate the thermal output of the system, assuming that it displaces electricity that would normally heat water in a conventional electric water heating system.

Because of the nature of the technology, the geothermal model calculates system performance over a period of years rather than hours.

SAM's detailed photovoltaic, PVWatts, solar water heating, and physical trough models can perform sub-hourly simulations for advanced analyses, but require sub-hourly [weather data](#) to do so.

## Photovoltaic Systems

SAM models grid-connected photovoltaic systems that consist of a photovoltaic array and inverter. The array can be made up of flat-plate or concentrating photovoltaic (CPV) modules with one-axis, two-axis, or no tracking.

## Detailed Photovoltaic

The [detailed photovoltaic model](#) calculates a grid-connected photovoltaic system's electrical output using separate module and inverter models. It requires module and inverter specifications along with information about the number of modules and inverters in the system. You can either provide your own module and inverter specifications from a manufacturer's data sheet, or choose a module and inverter from libraries. The detailed photovoltaic model models the effect of temperature on module performance, and has options for calculating shading and other losses in the system. The model also includes a system sizing calculator to help you determine the number of modules and inverters in the system.

Use the detailed photovoltaic model when you have information about the equipment that will be used in the system.

## PVWatts Model

The [PVWatts model](#) is an implementation of NREL's popular [online photovoltaic calculator](#). It models a grid-connected photovoltaic system using a few basic inputs to describe the system's nameplate capacity, array orientation and mounting type, and system losses. PVWatts makes internal assumptions about module and inverter characteristics for three types of modules. SAM's implementation of PVWatts includes options for modeling shading that are not available with the online version.

Use the PVWatts model for preliminary project analysis before you have information about the type of equipment you plan to use in the system, or for other analyses that require a reasonable estimate of a photovoltaic system's electrical output.

## High Concentration PV

The [high concentration photovoltaic](#) model is appropriate for grid-connected photovoltaic systems with high concentration photovoltaic (HCPV) modules. The concentrating photovoltaic model uses separate models to represent the module and inverter. It requires information about the design of the concentrator and efficiency of the cell at different irradiance levels. For the inverter model, you can either use specifications from a manufacturer data sheet, or choose an inverter from a library.

## Battery Storage

SAM's electric battery storage model is available with the Detailed Photovoltaic and Generic System models for either [front-of-meter](#) or [behind-the-meter](#) applications. A simplified version of the battery model is available with the PVWatts model.

## Detailed PV-Battery

The detailed PV-Battery model couples a grid-connected photovoltaic system to a battery bank, which can be connected to either the DC side of the photovoltaic inverter, or the AC side of the system. The model must be used with a financial model, and is modeled as a behind-the-meter application for the Residential, Commercial, and Third Party Ownership financial models, and a front-of-the-meter application for any of the Power Purchase Agreement (PPA) or Merchant Plant financial models. For behind-the-meter applications, there is an automatic sizing and dispatch option that uses NREL's REopt Lite API.

## PVWatts-Battery

The PVWatts-Battery model is a simplified implementation of the PV-Battery model for behind-the-meter applications that is available with the Residential, Commercial, or Third Party Ownership financial models and includes the automatic sizing and dispatch option that uses NREL's REopt Lite API.

## Generic System-Battery

The detailed PV-Battery model couples a grid-connected power system to a battery bank, which can be connected to either the DC side of the photovoltaic inverter, or the AC side of the system. The model must be used with a financial model, and is modeled as a behind-the-meter application for the Residential, Commercial, and Third Party Ownership financial models, and a front-of-the-meter application for any of the Power Purchase Agreement (PPA) or Merchant Plant financial models. For behind-the-meter applications, there is an automatic sizing and dispatch option that uses NREL's REopt Lite API.

## Concentrating Solar Power

The concentrating solar power (CSP) models are for grid-connected thermal power plants that use solar energy to generate steam to drive an electric power generation plant.

Note. The Integrated Solar Combined Cycle (ISCC) model was removed in SAM 2020.2.29. The model is still available as part of the Legacy version SAM 2018.11.11.

## Parabolic Trough (Physical Model)

The [physical trough model](#) calculates the electricity delivered to the grid by a parabolic trough solar field that delivers thermal energy to a power block for electricity generation, with an optional thermal energy storage system. The physical trough model characterizes many of the system components from first principles of heat transfer and thermodynamics, rather than from empirical measurements as in the empirical trough system model. While the physical model is more flexible than the empirical model (see below), it adds more uncertainty to performance predictions than the empirical model.

## Parabolic Trough (Empirical Model)

The [empirical trough model](#) models the same type of parabolic trough system as the physical trough model, but uses a set of curve-fit equations derived from regression analysis of data measured from the SEGS projects in the southwestern United States, so you are limited to modeling systems composed of components for which there is measured data. The model is based on Excelergy, originally developed for internal use at the National Renewable Energy Laboratory.

## Molten Salt Power Tower

A [molten salt power tower](#) system (also called central receiver system) consists of a heliostat field, tower and receiver, power block, and optional storage system. The field of flat, sun-tracking mirrors called heliostats focus direct normal solar radiation onto a receiver at the top of the tower, where a molten salt is heated and pumped to the power block. The power block generates steam that drives a conventional steam turbine and generator to convert the thermal energy to electricity.

## Direct Steam Power Tower

The Direct Steam Power Tower model is not included in versions released after November 2020. The model is available in the legacy SAM 2020.2.29 version, which you can download from the SAM [website download page](#).

## Linear Fresnel Molten Salt

A [molten salt linear Fresnel](#) system consists of a field of slightly curved or flat Fresnel reflectors that focus light on an absorber in the focal plane above the reflector. The absorber circulates a heat transfer fluid that transfers heat to a power block. The system may include thermal storage.

## Linear Fresnel Direct Steam

A [direct steam linear Fresnel](#) system consists of a field of slightly curved or flat Fresnel reflectors that focus light on an absorber in the focal plane above the reflector. Steam is used as the heat transfer fluid throughout the system. The system may not include thermal storage.

## CSP Generic Model

The [CSP generic model](#) model allows you to model a system that consists of a solar field, power block with a conventional steam turbine, and optional thermal energy storage system. The model represents the solar field using a set of optical efficiency values for different sun angles and can be used for any solar technology that uses solar energy to generate steam for electric power generation.

## Industrial Process Heat

### Process Heat Parabolic Trough

The [IPH parabolic trough](#) model is a version of the CSP physical parabolic trough model with no power cycle and modifications for process heat applications.

### Process Heat Linear Direct Steam

The [IPH linear direct steam](#) model is for a linear collector using direct steam with no power cycle and modifications for process heat applications.

## Marine Energy

Marine energy systems convert ocean wave or tidal energy to electricity.

### Wave Energy

The [marine energy wave](#) model is for a system that uses a wave energy converter (WEC) to convert the energy of ocean waves into electricity

### Tidal Energy

The [marine energy tidal](#) model is for a system that uses a tidal energy converter (TEC) to convert the energy of ocean tides into electricity.

## Generic System

The [generic system](#) model is a basic representation of a conventional power plant. The Generic technology option makes it possible to compare analyses of renewable energy project to a base case conventional plant using consistent financial assumptions.

The generic system model allows you to characterize the plant's performance either using one of two options:

- Specify a nameplate capacity and capacity factor value: Assumes that the plant generates power at a constant rate over the year.
- Specify an hourly or sub-hourly generation profile: Assumes that the plant generates power according to the generation profile you specify.

## Solar Water Heating

SAM's [solar water heating](#) model represents a two-tank glycol system with an auxiliary electric heater and storage tank for residential or commercial applications. The model allows you to vary the location, hot water load profiles, and characteristics of the collector, heat exchanger, and solar tanks.

## Wind

The [wind power](#) model can model a single small or large wind turbine, or a project with two or more large or small wind turbines that sells power to the grid.

## Fuel Cell-PV-Battery

The [fuel cell-PV-battery](#) model combines the PVWatts, battery, and a fuel cell model for systems that combine a photovoltaic array and fuel cell with an optional battery bank.

## Geothermal

**Note.** SAM's geothermal power model is for electricity-generating systems, not ground source heat pumps or geo-exchange systems.

A [geothermal power plant](#) uses heat from below the surface of the ground to drive a steam electric power generation plant. SAM analyzes the plant's performance over its lifetime, assuming that changes in the resource and electrical output occur monthly over a period of years, rather than over hours over a period of one year as in the solar and other technologies modeled by SAM.

## Biomass Power

A [biomass power system](#) burns a biomass feedstock (with or without supplementary coal) in a combustion system to generate steam that drives an electric power generation plant.

# 1.2 Financial Models

SAM's financial models calculate a project's cash flow over an analysis period that you specify. The cash flow captures the value of electricity generated by the system and incentives, and the cost of installation, operation and maintenance, taxes, and debt.

**Note.** SAM is designed to calculate the value of electricity generated by a system. The economic metrics it reports are based on units of electrical energy rather than thermal energy. The [solar water heating](#) model calculates the value of electricity saved by the system, assuming that heat from the system displaces heat that would be generated by a conventional electric water heater without the solar system.

The financial models can represent two main types of projects:

- Residential and commercial projects that buy and sell electricity at retail rates and displace purchases of power from the grid.

- PPA projects that sell electricity at a wholesale rate to meet internal rate of return requirements.

## Residential and Commercial Owner

In SAM, [residential](#) and [commercial](#) projects buy and sell power at retail rates. They may be financed through either a loan or cash payment (0% debt percent). These projects recover investment costs by selling electricity at rates established by the electricity service provider. SAM calculates metrics for these projects at the project level, assuming that a single entity develops, owns, and operates the project.

For residential and commercial projects, SAM calculates the project's [levelized cost of energy \(LCOE\)](#), which represents the cost of installing and operating the system, including debt and tax costs, and accounting for incentives. The model also calculates the [net present value \(NPV\)](#) of the after tax cash flow, and a [payback period](#) representing the number of years required for the cumulative after tax cash flow to cover the initial equity investment in the project.

Commercial projects may qualify for tax deductions under the Modified Accelerated Depreciation Schedule (MACRS) described in the United States tax code. SAM provides options for specifying custom depreciation schedules in addition to the MACRS mid-quarter and half-year schedules on the [Depreciation](#) page.

Residential and commercial projects are typically smaller than 500 kW, although SAM does not restrict system sizes, so it is possible to model any size system using either the residential or commercial financial model.

SAM's [Electricity Rates](#) page provides a range of options for specifying the retail electricity rate structure for a project. The rate structure may include any of the following:

- Flat buy and sell rates (with or without net metering)
- Time-of-use energy charges
- Monthly demand charges (either fixed or time-of-use)
- Tiered rates
- Fixed monthly charges

For projects with demand charges and tiered rates, SAM requires electric load data, which is specified on the [Electric Load](#) page.

## Third Party Ownership

In a third party ownership project, a photovoltaic system is installed on a residential or commercial property. The property owner, or customer, makes an agreement with a third party who installs, operates, and owns the system. The system reduces the customer's electricity bill, and the customer makes payments to the third party owner for the system, either through a lease agreement or a power purchase agreement.

The [Host](#) model is from the host perspective, and allows you to compare a lease agreement with a power purchase agreement.

The [Host / Developer](#) model is from the developer perspective to determine a power price that covers the developer's costs.

## Power Purchase Agreement (PPA)

PPA projects sell all of the electricity generated by the power system at a price negotiated through a power purchase agreement (PPA) to meet a set of equity returns requirements. A PPA project may involve one or two parties.

SAM provides options for calculating a power purchase price given a target internal rate of return, or for calculating the rate of return given a power purchase price.

The power price can be made to vary annually over the analysis period using either a fixed annual escalation rate, or by assigning a separate price to each year. The price can be made to vary diurnally using time-of-delivery (TOD) factors defined either using hour-by-month schedules or hourly (or subhourly) time series factors.

## Single Owner

In the [Single Owner](#) model, the project owner builds, owns, and operates the power system and has sufficient tax liability to fully utilize all tax benefits. The owner may be either the original developer or a third-party tax investor that purchases the project from the developer.

## Partnership Flip with and without Debt

The partnership flip with debt ([Leveraged Partnership Flip](#)) and partnership flip without debt ([All Equity Partnership Flip](#)) models are for two-party projects that involve equity investments by a project developer and a third party tax investor.

The investor has sufficient tax liability from its other business operations to fully utilize tax credits and depreciation deductions in the years in which the project generates the benefits. The project sets up a limited liability entity, and once the project begins generating and selling electricity, all of the project's net cash flows and tax benefits are passed through this entity to its owners.

The project allocates a majority of the cash and tax benefits to the investor when the project begins operation and until the "flip year" when tax investor receives a pre-negotiated after-tax internal rate of return or "target IRR." Once the target IRR is reached, a majority of the cash and any remaining tax benefits are allocated to the developer.

## Sale Leaseback

The [Sale Leaseback](#) model is another two-party structure that involves a tax investor purchasing 100% of the project from the developer and then leasing it back to the developer. This structure differs from the partnership flip structures in that the tax investor and the developer do not share the project cash and tax benefits (or liability). Instead, each party has its own separate cash flow and taxable income.

The purchase price paid by the tax investor is equal to the total project cost, less a lease payment and the value of working capital reserve accounts. The developer typically funds the reserve accounts to ensure it has some financial exposure. The tax investor receives lease payments from the developer and any ownership-related incentives such as the tax credits, incentive payments, and the depreciation tax deductions. The developer operates the project and keeps any excess cash flow from operations, after payment of all operating expenses and the lease payments. This provides the developer with an incentive to operate the project as efficiently as possible.

**Note.** SAM assumes that the tax investor receives the ITC in the sale leaseback structure. SAM does not model alternative lease structures that treat the ITC differently.

Below is a table summarizing the five structures.



	All Equity Partnership Flip	Leveraged Partnership Flip	Sale Leaseback	Single Owner
<b>Equity Owners</b>	Tax investor Developer	Tax investor Developer	Tax investor (Lessor)	Developer (third party if sold)
<b>Project Debt</b>	No	Yes	No	Optional (owner choice)
<b>Return Target</b>	Tax investor after-tax IRR (Flip Target)	Tax investor after-tax IRR (Flip Target)	Lessor after-tax IRR	Owner after-tax IRR
<b>Cash Sharing</b>	Pre-Flip: Bifurcated Post-Flip: Primarily developer	Pre-Flip: Pro rata Post-Flip: Primarily developer	Lessor: Lease payment Lessee: Project margin	Owner receives 100% of project cash
<b>Tax Benefit Sharing</b>	Pre-Flip: Primarily tax investor Post-Flip: Primarily developer	Pre-Flip: Primarily tax investor Post-Flip: Primarily developer	Tax investor and developer have different taxable incomes ITC and Depreciation goes to tax investor	Owner receives 100% of project tax benefits

## Merchant Plant

The [Merchant Plant](#) model is similar to the Single Owner model described above, except that power generated by the system is sold at market prices that can vary on an hourly (or subhourly), daily, or monthly basis over the project life. Revenue can be from energy production, ancillary services and capacity payments, or a combination of the three.

## LCOE Calculator

The [LCOE calculator](#) uses a simple method to calculate the project's levelized cost of energy (LCOE). You provide the installation cost, operating costs, and a fixed charge rate as input, and the model calculates the LCOE based on the annual energy generated by the system. The calculator can also calculate the fixed charge rate when you provide basic financial parameters.

## 1.3 User Support

For information about SAM in addition to this Help system, please use the following resources on the [SAM website](#):

- Support forum to search for answers and post questions about SAM. To participate in the forum, you must [register](#) on the SAM website.
- See the Events page for links to upcoming webinars, online round tables and other SAM-related events.

- Webinar recordings are available on the Videos page of the performance and financial model pages.
- Technical references for SAM's performance model are listed on the Publications page for each technology.
- Excel workbooks documenting methods in SAM's financial models are listed on the Financial Model pages.

To contact SAM support:

- Post a question or comment on the [Support forum](#).
- Send an email to [sam.support@nrel.gov](mailto:sam.support@nrel.gov).

## 1.4 SAM Versions

NREL releases new SAM versions and updates periodically. You can download the latest version from the SAM website at <https://sam.nrel.gov/download>.

SAM's [Welcome page](#) also displays news from the SAM team, including announcements of new versions.

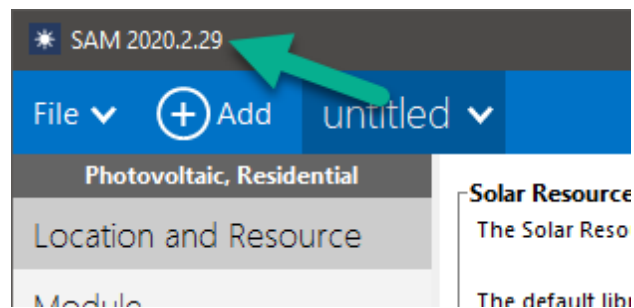
Related topics:

- [Software Installation](#)
- [Registration](#)

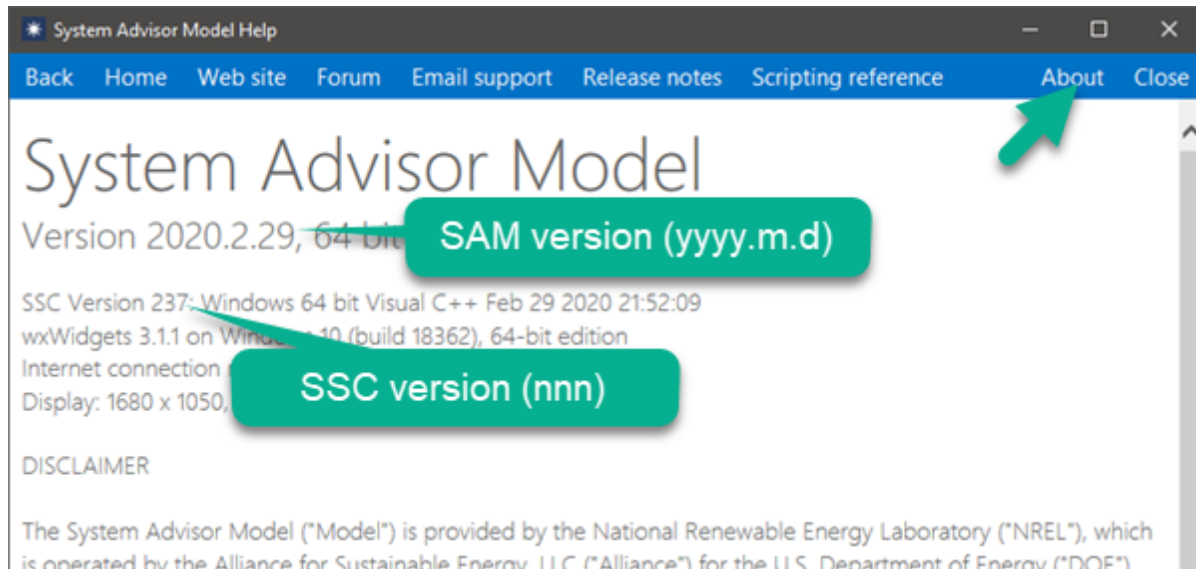
### SAM Version Information

The SAM version number consists of a date and may be followed by a revision number. For example SAM 2018.1.18 r4 was originally released on January 18, 2018 and updated to Revision 4.

SAM displays the version number in the title bar of the Main window:



You can more detailed SAM version information by opening a Help window (press the F1 key or click **Help**) and then clicking **About**:



## Updating SAM

If a newer version of SAM is available on the SAM website than the version installed on your computer, you can download and install it to update SAM. You can either keep the older version on your computer, or remove it using your operating system's uninstall program.

## Legacy Versions

In some cases you may want to use a legacy version of SAM instead of the current version, for example to compare results from older versions, or to use a feature that has been discontinued in the current version. You can download legacy versions from the SAM website at <https://sam.nrel.gov/download>. See [Software Installation](#) for more information.

## 1.5 Models and Databases

This topic lists all of SAM's performance models and describes the component-level models and databases SAM uses.

### System Performance Models

The system models represent a complete renewable energy system and were developed by NREL using algorithms from partners listed below.

Model Name	Model Developer
Photovoltaic (detailed)	NREL with component models from Sandia National Laboratories and the University of Wisconsin
Photovoltaic (PVWatts)	NREL
High concentration PV	NREL
Wind	NREL
Biomass Combustion	NREL
Geothermal	NREL, Princeton Energy Resources International
Solar Water Heating	NREL
Generic System	NREL
CSP Parabolic Trough (Physical)	NREL, University of Wisconsin
CSP Parabolic Trough (Empirical)	NREL
CSP Power Tower Molten Salt	NREL, University of Wisconsin
CSP Linear Fresnel Molten Salt	NREL
CSP Linear Fresnel Direct Steam	NREL
CSP Generic Model	NREL
CSP Integrated Solar Combined Cycle	NREL
Process Heat Parabolic Trough	NREL
Process Heat Linear Fresnel Direct Steam	NREL

### Component Performance Models

The detailed photovoltaic and wind power models include options for choosing a component performance model to represent part of the system.

Model Name	Component	Developer
Simple Efficiency Module Model	Photovoltaic module	NREL
CEC Performance Model with Module Data base	Photovoltaic module	University of Wisconsin
CEC Performance Model with User Entered Specifications	Photovoltaic module	Adapted by NREL
Sandia PV Array Performance Model with Module Database	Photovoltaic module	Sandia National Laboratories
Single Point Efficiency Inverter	Inverter	NREL
Sandia Performance Model for Grid Connected PV Inverters	Inverter	Sandia National Laboratories
Wind Turbine Design Model	Wind Turbine	NREL
Wind Power Curve Model	Wind Turbine	NREL

### Component Parameter Databases

Some of the component models use a library of input parameters to represent the performance characteristics of the component. The libraries listed below are owned by organizations other than NREL.

Library Name	Component	Owner
CEC Modules	PV module	California Energy Commission
Sandia Inverters	Inverter	Sandia National Laboratories
Sandia Modules	PV module	Sandia National Laboratories

### Online Financial Model Data

SAM can automatically download data from the following online databases to populate values on its financial model input pages.

Database Name	Type of Data	Database Manager
<a href="#">OpenEI U.S. Utility Rate Database</a>	Retail electricity prices and rate structures	NREL and Illinois State University

### Online Renewable Resource and Weather Data Sources

SAM can automatically download renewable energy resource and weather data from the following online databases.

Database Name	Type of Resource Data	Database Manager
<a href="#">National Solar Radiation Database</a>	Solar and Meteorological	NREL
<a href="#">Wind Integration Datasets</a>	Wind and Meteorological	NREL with 3Tier and AWS Truepower

## Solar and Wind Resource Files

SAM comes with a small set of sample weather files for the solar and wind performance models. You can use the download tools on the Location and Resource page to download solar resource data and from the Wind Resource input page to download wind data.

# 2 Getting Started

The following procedure describes the basic steps to set up and run a simulation of a project.

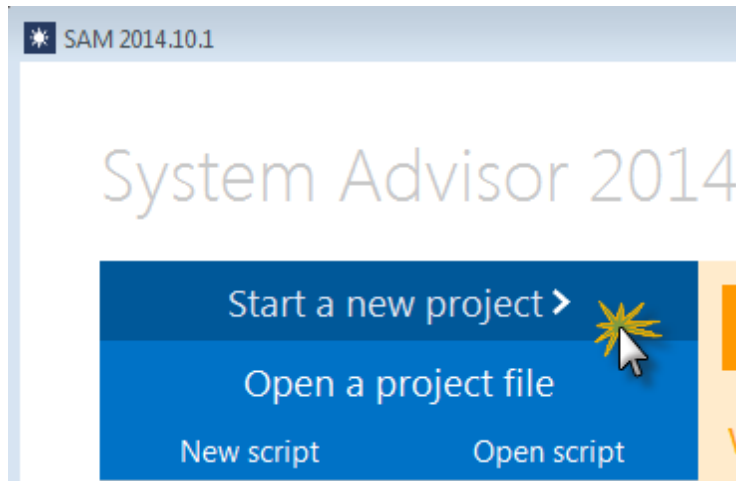
### See also:

- [Financial Models](#)
- [Performance Models](#)

## 1. Create a project

When you start SAM, it displays the [Welcome page](#) with several options for creating or opening a file.

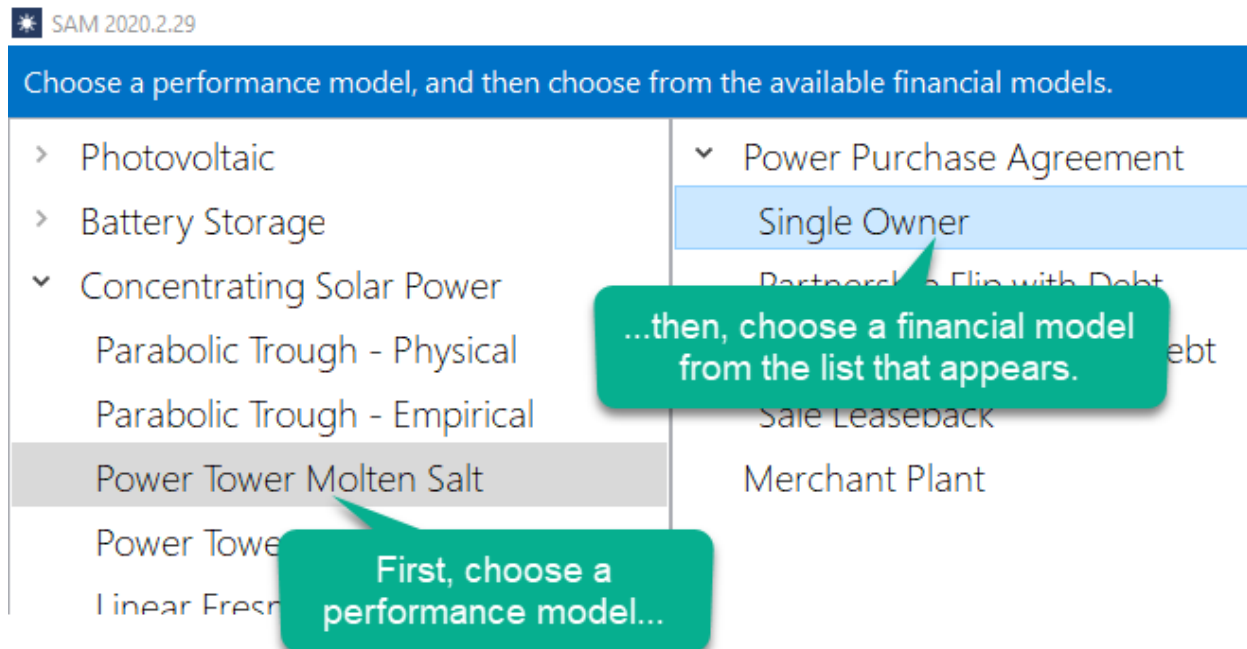
To [create a project](#), **Start a new project**.



## 2. Choose models

Your project is made up of a [performance model](#) for the power system and an optional [financial model](#) for the project's financial structure.

To [choose models](#), click the performance model name in the list, and then click the financial model that appears in the list to the right:



When you choose a financial model, and click **OK**, SAM creates a new file and populates all of the input variables with values from the default values database.

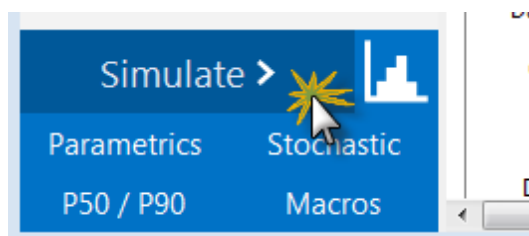
### 3. Review inputs

After creating your file, open each input page and review the default assumptions.

See [Input Pages](#) for details.

### 4. Run a simulation

To run a simulation, click **Simulate** at the bottom left of the main window.



See [Run Simulation](#) for details.

### 5. Review results

When simulations are complete, SAM displays a summary of results in the Metric table.

Metric	Value	
Annual energy	37,211,968 kWh	Performance metrics
Capacity factor	21.2%	
First year kWhAC/kWDC	1,861 kWh/kW	
Performance ratio	0.78	
PPA price (Year 1)	10.33 ¢/kWh	Financial metrics
PPA price escalation	1.00 %	
Levelized PPA price (nominal)	11.20 ¢/kWh	
Levelized COE (nominal)	10.48 ¢/kWh	
Net present value	\$2,727,177	
Internal rate of return (IRR)	11.00 %	
Year IRR is achieved	20	
IRR at end of analysis period	12.76 %	
Net capital cost	\$41,179,084	
Equity	\$19,478,956	
Size of debt	\$21,700,130	

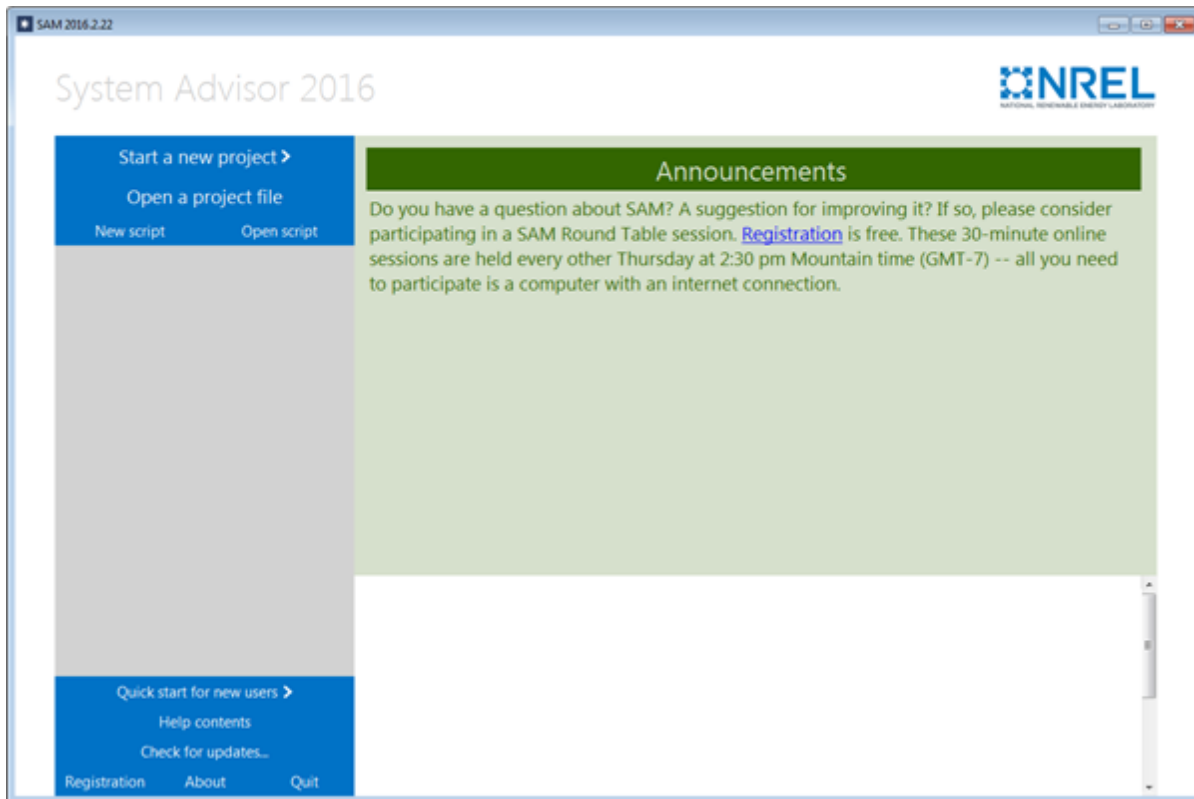
You can display graphs and tables of detailed results data on the [Results page](#).

## 2.1 Welcome Page

When you start SAM, it displays the Welcome page with options for starting your work session and messages about SAM from NREL's SAM development team.

**Tip.** To return to the Welcome page after creating a case, on the File menu, click **Close**, or press ctrl-W.



**To start a new project:**

1. Click **Start a new project**.
2. [Choose models](#).

**Note.** If you are modeling a wind system, you can use the Wind Wizard to create the project. The Wizard steps you through the inputs you need to create a basic case. To run the Wind Wizard, click **Quick start for new users** at the bottom left corner of the Welcome page, and then click **Wind Wizard**.

**To open an existing SAM project:**

1. Click **Open a project file** to open an existing SAM project stored in a *.sam* file.
2. Double-click the name of a recent *.sam* file in the list at the bottom right of the Welcome page.

**To create or open an LK script:**

- Click **New script** to create a new [script](#), or click **Open script** to open an existing script stored in a *.lk* file.

**To see or change your registration information:**

- Click **Registration**.  
The SAM [Registration](#) window displays the email address you used to register SAM and your SAM key.

**To display version information:**

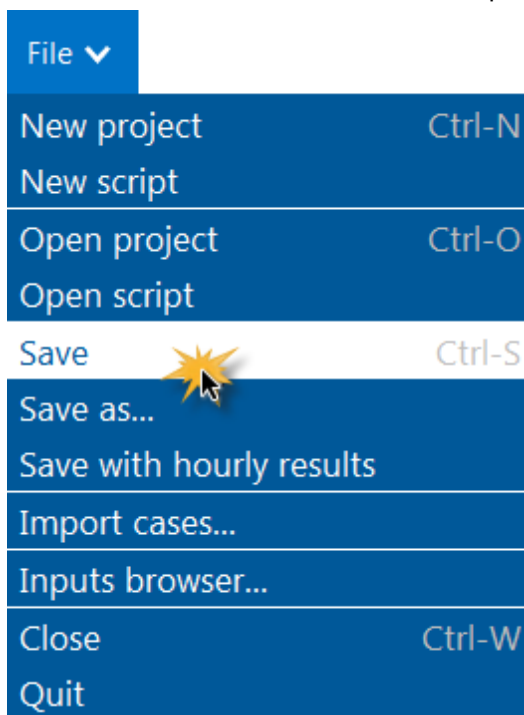
- Click **About**.  
The About page displays the versions numbers for your copy of SAM along with the NREL legal disclaimer.

## 2.2 Create a Project

A SAM project consists of one or more [cases](#). Each case stores inputs and results for a renewable energy system. When you save a project, SAM creates a project file with the *.sam* extension.

**To create a SAM project:**

1. On the [Welcome page](#), click **Start a new project** to create a new project, or on the [File menu](#), click **New project**.
2. [Choose models](#) for your project.  
SAM creates the project with a single case with all input variables populated with default values.
3. On the File menu, click **Save** to save the project as a *.sam* file.



## 2.3 Choose Models

When you create or modify a case, you must choose the performance and financial model that best describes your project.

 SAM 2020.2.29

Choose a performance model, and then choose from the available financial models.

> Photovoltaic	▼ Power Purchase Agreement
> Battery Storage	Single Owner
▼ Concentrating Solar Power	Partnership Flip with Debt
Parabolic Trough - Physical	Sale Leaseback
Parabolic Trough - Empirical	Merchant Plant
Power Tower Molten Salt	
Power Tower	
Linear Fresnel	

...then, choose a financial model from the list that appears.

First, choose a performance model...

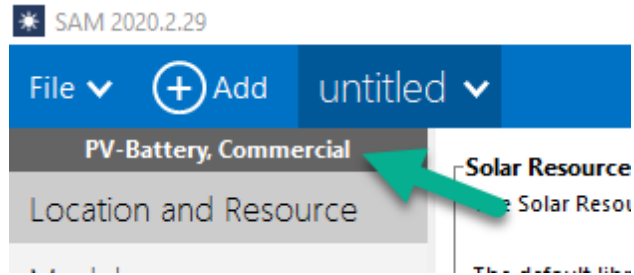
### **To choose the performance and financial model:**

1. Choose a performance model: In the left column, click the name of the performance model for case. For a description of the models, see [Performance Models](#).  
When you choose a performance model, SAM displays the all of financial models available for that performance model.
2. Choose a financial model: In the right column, click the name of the financial model. For a description of the financial models, see [Financial Models](#).
3. Click **OK** to create or modify the case.

**Note.** When you change the performance or financial model for a case, SAM populates new variables with default values. Be sure to review the variables on each [input page](#) to make sure that they are appropriate for your analysis.

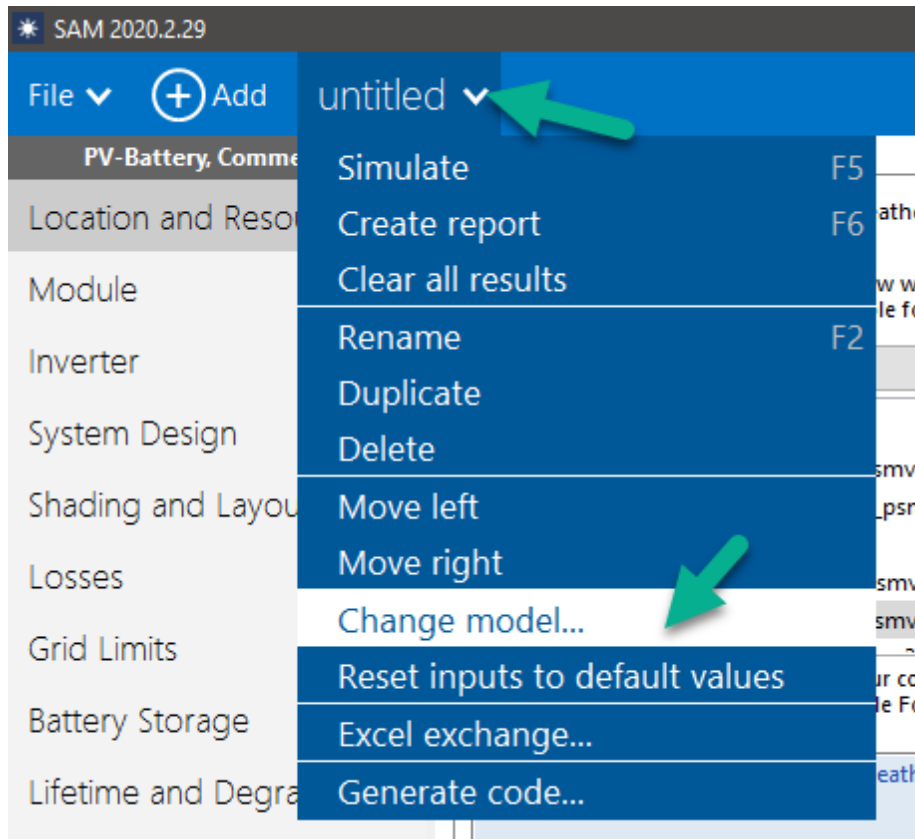
### **Identifying the Models for a Case**

When SAM displays the case, you can verify that the performance and financial model are correct on the Main Window:



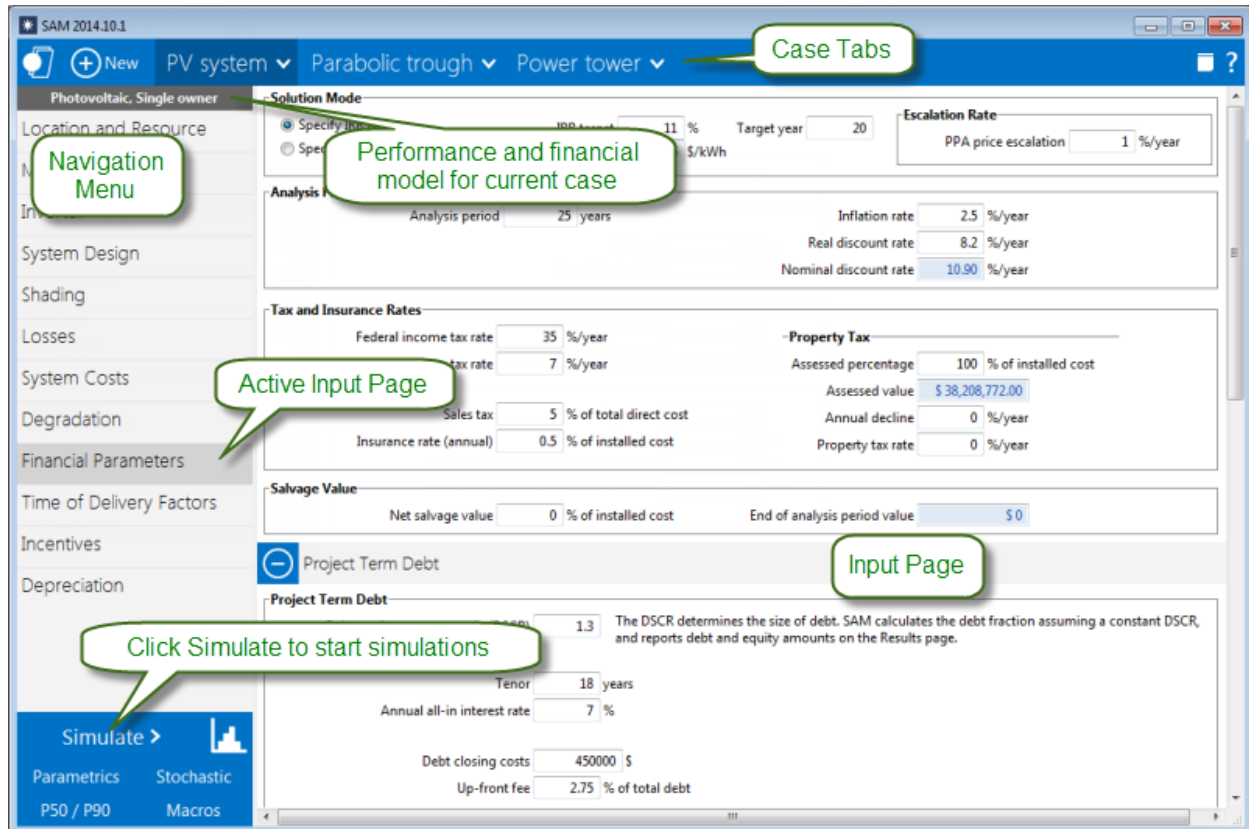
### Changing a Case's Models

To change the performance model or financial model for an existing case, on the case's menu, click **Change model**:




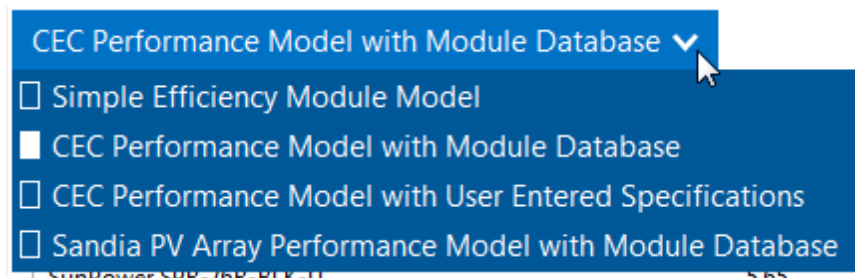
## 2.4 Main Window

After you [choose the models for your analysis](#), SAM displays the main window, which gives you access to the input pages for each case in the project:



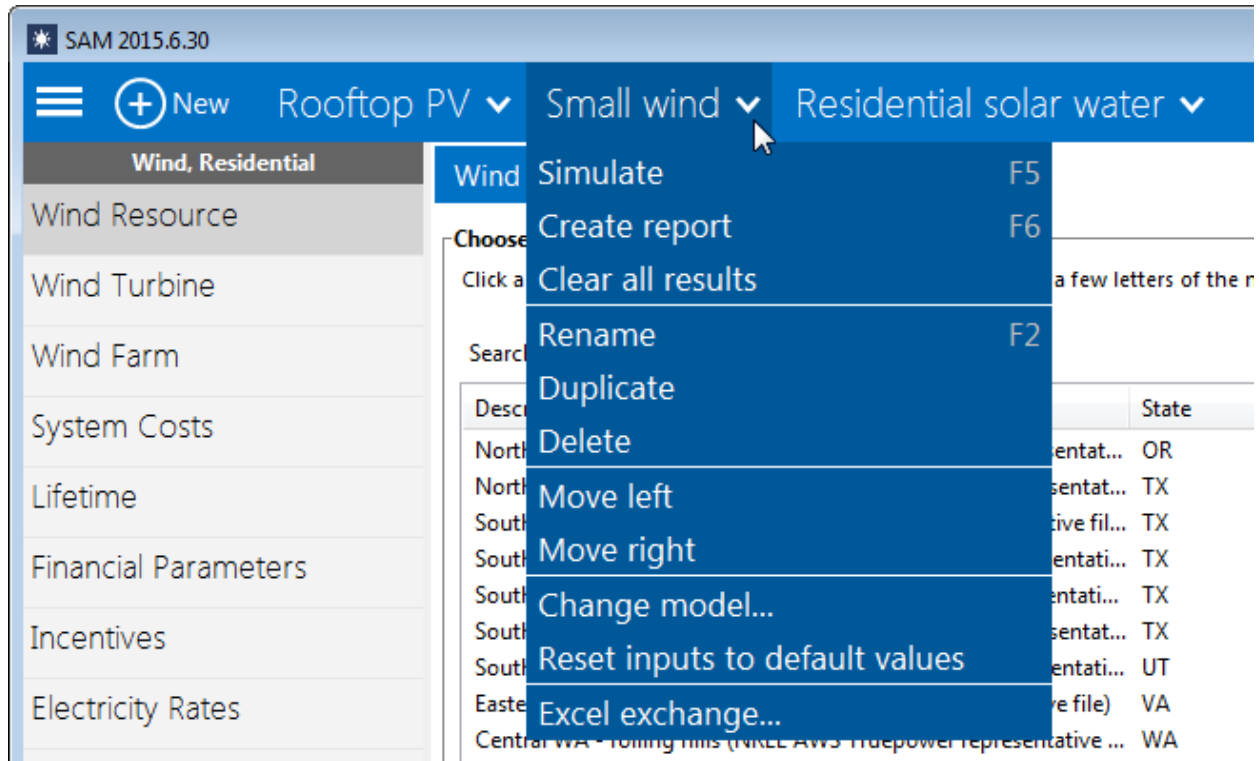
### Shortcut Menus

A  down arrow in SAM indicates a context menu. Click the button to show a list of commands or options:



## Case Tabs

The case tab cases in the project and a context menu with commands for [managing cases](#). A project may consist of a single case, or may contain more than one case.



## 2.5 Input Pages

Use the input pages to verify and change values of input variables for your analysis.

- The [navigation menu](#) displays different input pages.
- [Text and variable colors](#) indicate whether a variable is an input or calculated value, and whether or not it is active.

The screenshot displays the SAM 2014.10.1 software interface for a Parabolic Trough Power Tower system. The interface is organized into several sections:

- Solar Field Parameters:** Includes options for Option 1 and Option 2, with fields for Solar multiple (2), Field aperture (877000 m<sup>2</sup>), Row spacing (15 m), Stow angle (170 deg), Deploy angle (10 deg), Number of field subsections (2), Header pipe roughness (4.57e-005 m), HTF pump efficiency (0.85), Freeze protection temp (150 °C), Irradiation at design (950 W/m<sup>2</sup>), and Allow partial defocusing (checked).
- Heat Transfer Fluid:** Shows Field HTF fluid (Therminol VP-1), User-defined HTF fluid (Edit...), Field HTF min operating temp (12 °C), Field HTF max operating temp (400 °C), Design loop inlet temp (293 °C), Design loop outlet temp (391 °C), Min single loop flow rate (1 kg/s), Max single loop flow rate (12 kg/s), Min field flow velocity (0.356109 m/s), Max field flow velocity (4.96554 m/s), Header design min flow velocity (2 m/s), and Header design max flow velocity (3 m/s).
- Design Point:** Displays Single loop aperture (3762.4 m<sup>2</sup>), Loop optical efficiency (0.744601), Total loop conversion efficiency (0.716894), Total required aperture, SM=1 (431859 m<sup>2</sup>), Required number of loops, SM=1 (114.783), Actual number of loops (230), Total aperture reflective area (865352 m<sup>2</sup>), Actual solar multiple (2), and Field thermal output (588.235 MWt).
- Collector Orientation:** Shows Collector tilt (0 deg) and Collector azimuth (0 deg), with a note: Tilt: horizontal=0, vertical=90; Azimuth: equator=0, west=90, east=-90.
- Mirror Washing:** Includes Water usage per wash (0.7 L/m<sup>2</sup>, aper.) and Washes per year (63).
- Plant Heat Capacity:** Shows Hot piping thermal inertia (0.2 kWh/K-MWt), Cold piping thermal inertia (0.2 kWh/K-MWt), and Field loop piping thermal inertia (4.5 Wh/K-m).
- Land Area:** Displays Solar Field Area (641 acres), Non-Solar Field Land Area Multiplier (1.4), and Total Land Area (898 acres).

A navigation menu on the left lists various input pages: Location and Resource, Solar Field, Collectors (SCAs), Receivers (HCEs), Power Cycle, Thermal Storage, Parasitics, System Costs, Degradation, Financial Parameters, Time of Delivery Factors, Incentives, and Depreciation. A 'Simulate >' button is visible at the bottom left. Two callouts highlight specific elements: 'Button to select input page' points to the 'Solar Field' menu item, and 'Input page' points to the 'Design Point' section.

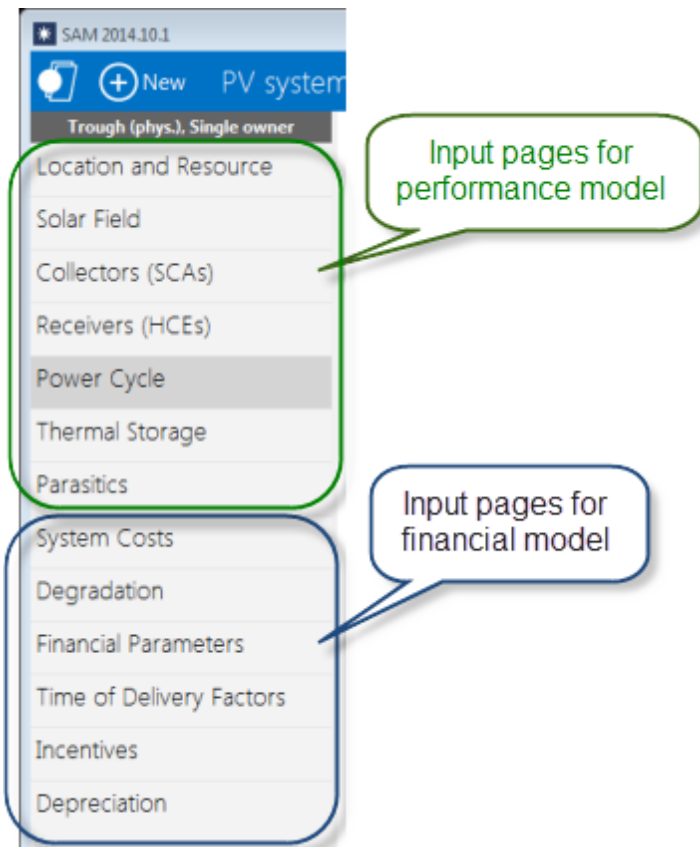
SAM's input pages provide access to the input variables and options that define the assumptions of your analysis.

When you start a project by creating a new file SAM populates all of the input variables with default values so that you can get started with your analysis even before you have final values for all of the input variables.

**Tip.** To see a [list of all input variables](#) and their values for each case in your file, on the File menu, click **Inputs browser**.

## Navigation Menu

The navigation menu shows buttons for input pages for the performance model at the top of the list, and input pages for the financial model at the bottom:



## Colors of Text and Variables

SAM indicates different kinds of variables with colors.

## Input Variables

Input variables that you can change are in white boxes with black values:

Capital Costs	
	Cost per kW
Turbine cost	\$4,673.00/kW
Balance of System cost	\$2,267.00/kW

## Calculated Values

Blue indicates a value that you cannot edit: Either a calculated value, a value from another input page, or a value from a [library](#):

Optical Calculations	
Length of single module	8.33333 m
IAM at summer solstice	1.00366



Tip. In Windows, press the F1 key (Command-? in OS X) to see the Help topic with descriptions of the equations SAM uses for most calculated values.

## Inactive Variables

Gray data boxes show values for your reference. For example, these input variables on the Location and Resource page show annual averages calculated from data stored in the weather file. You cannot modify data in gray:

NOCT method parameters

Mounting standoff	Ground or rack mounted
Array height	One story building height or lower

## Web Links

Blue underlined text indicates links to websites with useful information related to the input page:

[Visit SAM weather data website](#)

## 2.6 System Costs

When you run SAM, you provide information about the cost of installing and operating the system by specifying inputs on the System Costs page. SAM organizes the costs into three categories:

- Direct capital costs for equipment purchases and installation labor
- Indirect capital costs for permitting, engineering, and land-related costs
- Operation and maintenance costs for labor, equipment, and other costs associated with operating the project

You can also specify costs associated with financing the project on the [Financial Parameters](#) page:

- Construction loan
- Project loan
- Taxes and insurance
- Fees associated with the project structure for projects involving two partners or a lease

When you create a new case or file, SAM populates inputs with default values to help you get started with your analysis. For example, if you create a case for a utility-scale photovoltaic project with a single owner, SAM populates the inputs on the Financial Parameters and System Costs pages with values that are reasonable for a typical PV project for power generation in the United States. The default values are just a starting point: As you develop and refine your analysis, you should change the inputs to values that are appropriate for your analysis scenario.

Here's an example: The default module cost for a PV project with the single owner financial model in SAM 2012.5.11 is \$1.95/Wdc. That cost is based on NREL research on benchmark prices in the United States to help the U.S. Department of Energy's Solar Energy Program evaluate its programs. Obviously, the module price for a real project is likely to be different than the benchmark U.S. price, and it is up to you to determine

appropriate costs for your analysis. For the other technologies (concentrating solar power, wind, biomass, geothermal, and solar water heating), the default costs are similarly representative values based on the U.S. market at the time of the SAM release.

**Note.** For a list of web resources with costs for renewable energy projects, see Cost Data pages for each technology on the [SAM website](#).

SAM displays different cost categories on the System Costs page for different technologies:

- [Photovoltaic \(PV\) Systems](#) (with and without battery storage)
- [Wind](#)
- [Marine Energy Wave](#)
- [Marine Energy Tidal](#)
- [Biomass Combustion](#) and [Biomass Feedstock](#)
- [Geothermal Power](#)
- [Solar Water Heating](#)
- [Generic System](#) (with and without battery storage)
- [Parabolic Trough](#)
- [Power Tower](#)
- [Linear Fresnel](#)
- [Generic Solar Model](#)

## 2.7 Financial Model Inputs

### Annual Electrical Output

The cash flow models for the different financial models require a single value representing the system's total electrical output in a single year to determine the project's annual income (PPA models) or savings (distributed generation models). The [performance model](#) calculates this value by adding up the results of an hourly (or sub-hourly) simulation of the system's performance over the year. The [weather data](#) and system's technical specifications from the performance model's input pages determine the annual output of the system.

When you specify a **degradation rate** on the [Lifetime](#) page, SAM reduces the annual output from year to year in Years Two and later. When the value rate is zero, SAM assumes that the annual output is the same for all years in the analysis period.

**Note.** For [geothermal systems](#), SAM uses a different method for calculating annual output that depends on the long-term resource data rather than the degradation rate.

### Financial Model Inputs

SAM's input pages are organized so that groups of related input variables appear together. Variables on the following input pages are inputs to the financial models. The input pages that are available depend on the financial model:

[System Costs](#) (all models): Installation and operation and maintenance (O&M) costs for the project.

Financial Parameters (all options): Financial structure, debt parameters, tax and insurance rates, partner shares, etc:

- [Residential](#)
- [Commercial](#)
- [Third Party Ownership - Host](#)
- [Third Party Ownership - Host / Developer](#)
- [Single Owner](#)
- [Merchant Plant](#)
- [All Equity Partnership Flip](#)
- [Leveraged Partnership Flip](#)
- [Sale Leaseback](#)
- [LCOE Calculator](#)

Incentives:

- [Incentives](#) (all models): Tax credits and cash incentives.
- [Depreciation](#) (commercial and PPA models): Accelerated depreciation tax benefit.

Electricity Rates and Load:

- [Electricity Rates](#) (residential and commercial models): Retail electricity pricing.
- [Electric Load](#) (residential and commercial models): Building electricity usage.

Thermal Rates and Load:

- [Thermal Rates](#) (fuel cell model with commercial financial model): Retail thermal energy pricing.
- [Thermal Load](#) (fuel cell model): Thermal energy usage.

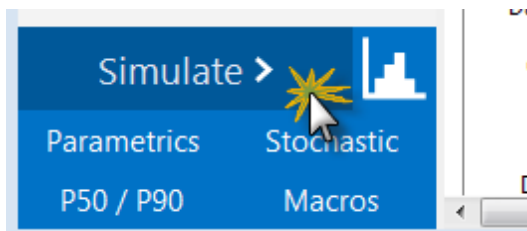
## Financial Model Results

The [Results page](#) displays the [cash flow](#) and economic [metrics](#) that summarize the cash flow, such as the [levelized cost of energy \(LCOE\)](#), [net present value \(NPV\)](#), and others depending on the financial model.

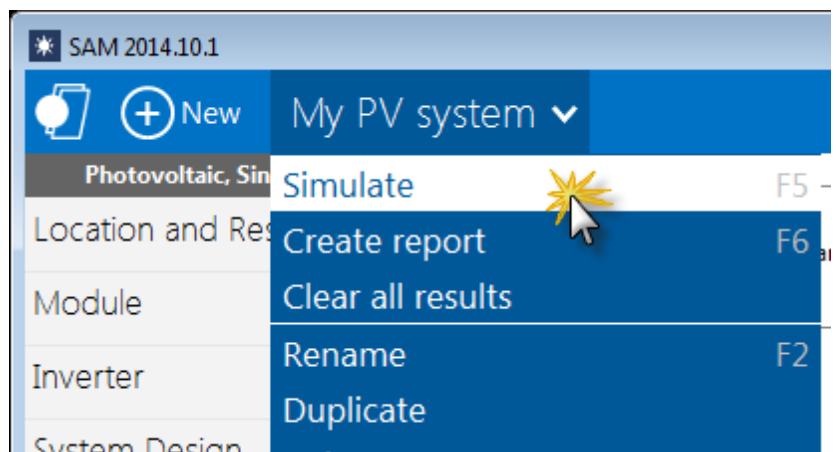
## 2.8 Run Simulation

After reviewing and modifying inputs on the [input pages](#), click **Simulate** to run a simulation.

After you run a simulation, SAM may display [notices](#) with information about the simulation. You can also display the notices any time by clicking **Notices**.



You can also run a simulation from the Case menu or by pressing the F5 key:

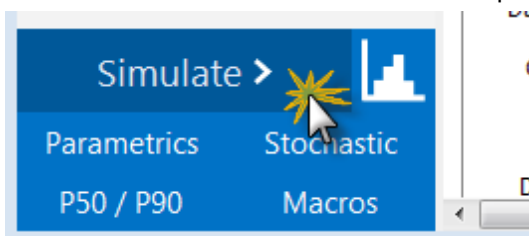


## 2.9 Results

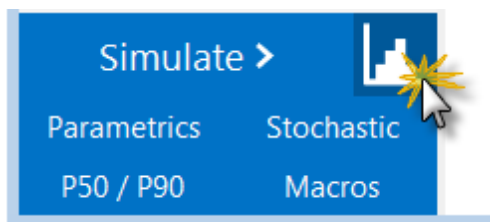
After you run a simulation, SAM displays results from both the performance and financial models. You can [export data](#) from any graph or table displayed on the results pages to Excel or text files.

### To display results:

- Click **Simulate** to run a simulation and display results.



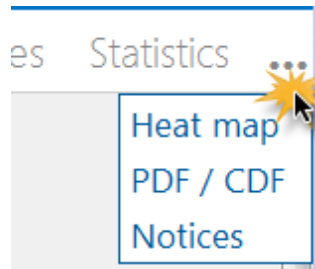
Or, click Switch to Results  to show results without running a simulation.



Use the tabs along the top of the Results page to display tables and graphs of data:

[Summary](#) [Losses](#) [Graphs](#) [Data](#) [Cash flow](#) [Time series](#) [Profiles](#) [Statistics](#) [Heat map](#) [PDF / CDF](#) [Notices](#)

If you do not see all of the tabs because of the width of your computer's screen, click the ellipses to show tabs that do not fit in the horizontal bar:



## Performance Model Results

- [Summary](#) displays the [Metrics table](#) with key metrics and graphs that summarize the performance model results, such as total annual electrical output, capacity factor, etc.
- [Losses](#) shows an energy loss diagram (not available for all performance models).
- [Graphs](#) allows you to create graphs of variables with hourly, monthly, annual, and single values.
- [Data](#) allows you to build tables of hourly, monthly, and annual results.
- [Time series](#) graphs display time series data and statistical graphs of hourly or subhourly data.
- [Profiles](#) displays time series data as daily profiles by month.
- [Statistics](#) displays the mean, maximum, minimum, sum, standard deviation, and average daily minimum and maximum values of time series data.
- [Heat map](#) displays one year's worth of time series data set in a single two-dimensional graphical representation using colors to indicate magnitude.

## Financial Model Results

SAM's financial model uses the sum of the performance model's 8,760 hourly output values in kWh as an input representing the system's total annual electrical output in kWh. The financial model then calculates the project's cash flow based on the inputs you specify on the System Costs and Financial Parameters pages. SAM displays financial model results in the following places:

- [Summary](#) displays the [Metrics table](#) with key metrics such as the LCOE, PPA price, IRR, and payback period and graphs of the project's after-tax cash flow.
- [Cash Flow](#) shows details of the project's cash flow.
- [Data](#) allows you to build tables of cost and cash flow data along, metrics, and time-dependent electricity sales and price data.
- [Time series data](#) includes time-dependent electricity sales and price data.

## 2.10 Videos

For video demonstrations of SAM's performance and financial models and other features, see the Videos pages for the different performance and financial models on the [SAM Website](#).

See the [SAM YouTube channel](#) for recordings of all SAM webinars.

To register for upcoming webinars and round tables, see the SAM website [Events page](#).

**Note.** The videos may show features in older versions of SAM that have been updated since the recording was made.

## 3 Reference

### 3.1 File Menu

SAM's File menu provides access to commands for managing projects and scripts, and opening the inputs browser. See [Keyboard Shortcuts](#) for additional functions.

File ▾	
New project	Ctrl-N
New script	
Open project	Ctrl-O
Open script	
Save	Ctrl-S
Save as...	
Save with hourly results	
Import cases...	
Inputs browser...	
Close	Ctrl-W
Quit	

#### New project

Create a new project file using default input values. SAM opens a project with a single case and no results.

#### New script

Open the script editor for a new [LK script](#).

#### Open project

Open an existing SAM project file (*.sam*) file.

#### Open script

Open an existing script file (*.lk*) in the script editor.

#### Save

Save the project as a SAM (*.sam*) file in its current location.

This option saves annual and monthly results, but does not save hourly results to minimize the size of the file. When you open the file after closing it you will need to run a simulation to view hourly data on the [Results](#) page.

#### Save As

Save the project as a SAM (*.sam*) file in a different location or with a new name.

#### Save with hourly results

Save the project as a SAM (*.sam*) file in its current location, and include hourly results.

Use this option if you want hourly data to be available on the Results page when you or someone else next open the file after closing it.

#### Import cases

Import one or more cases from another *.sam* project file.

**Inputs browser**

The [inputs browser](#) lists all of the input variables for all cases in the project file. You can use the browser to export a list of input variables and their values to CSV files, and to compare input variables across cases in your file.

**Close**


Close the project without exiting SAM or saving a file.

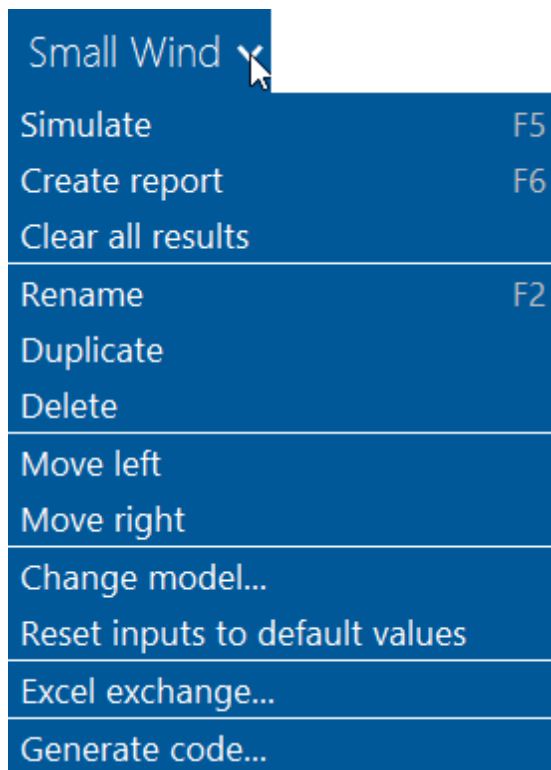
SAM displays the [Welcome page](#) when you close a project.

**Quit**

Close the project and exit SAM without saving a file.

## 3.2 Case Menu

The case menu displays commands for the current case. Click the  arrow on the case tab to display the menu. See [Keyboard Shortcuts](#) for additional functions.

**Simulate**

[Runs a simulation](#) for the current case. Equivalent to clicking the Simulate button.

**Create report**

Run the [report generator](#) to create a PDF report for the current case. When you create a report, SAM first runs a simulation to be sure there are results to include in the report.

**Clear all results**

Clears results from the current case. SAM removes any graphs you may have created for the case.

**Rename**

Change the name of the current case.

**Duplicate**

Create a copy of the current case.

**Delete**

Delete the current case.

**Move left**

Move the current case's tab to the left in the toolbar.

**Move right**

Move the current case's tab to the right in the toolbar.

**Change model**

Change the performance model, financial model, or both for the current case.

When you change one model, SAM retains the input values of the other model and assigns default values to the inputs of the model you changed. For example, if you change a PVWatts/Residential case to Detailed Photovoltaic/Residential, SAM keeps the Residential financial model's inputs, and changes the performance model to detailed photovoltaic with its default values.

**Reset inputs to default values**

Replaces all inputs variable values with default values.

**Excel exchange**

Configure the case for [Excel Exchange](#) to exchange input variable values with a Microsoft Excel workbook.

**Generate Code**

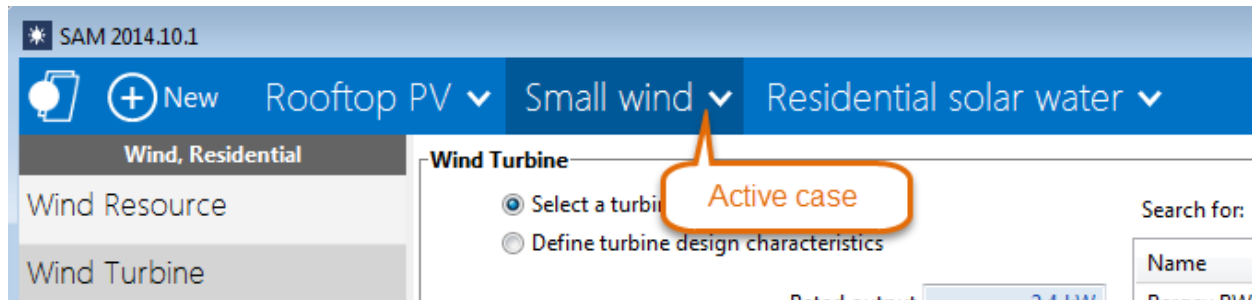
Export the input variables for the current case to a text file containing code in one of the languages supported by the [Software Development Kit](#).

### 3.3 Manage Cases

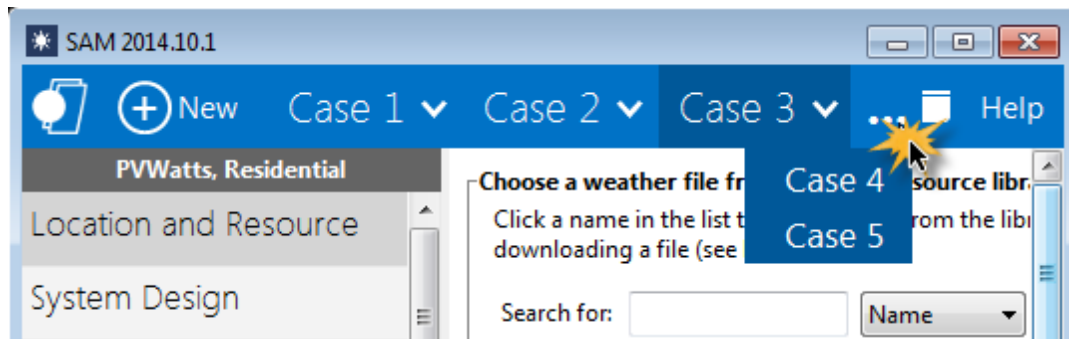
A case is a complete set of input data and results. A project file contains at least one case. SAM uses tabs to display each case in the file, analogous to the way Excel displays worksheets in a workbook.

SAM highlights the active case name:





When there are more cases than can be displayed, click the ellipses to list the cases that are not visible:



## Why Use Cases?

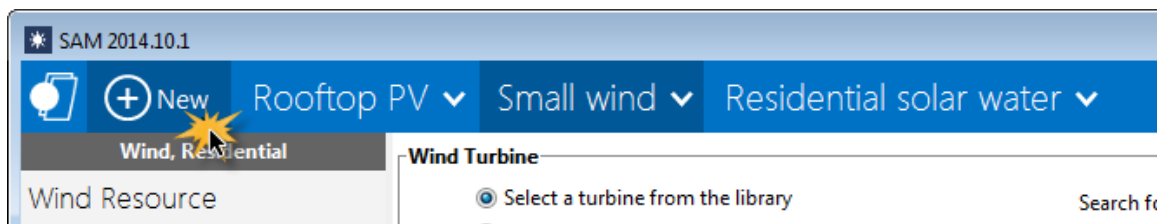
By creating more than one case in a file, you can easily compare the assumptions and results of different analysis scenarios. For example, you could use cases to compare the cost and performance of a residential photovoltaic system in several locations by defining a separate case for each location, or you could compare a utility-scale photovoltaic and concentrating solar power systems.

**Tip.** You can use the [inputs browser](#) to compare values of input variables in different cases.


## Creating, Renaming, and Deleting Cases

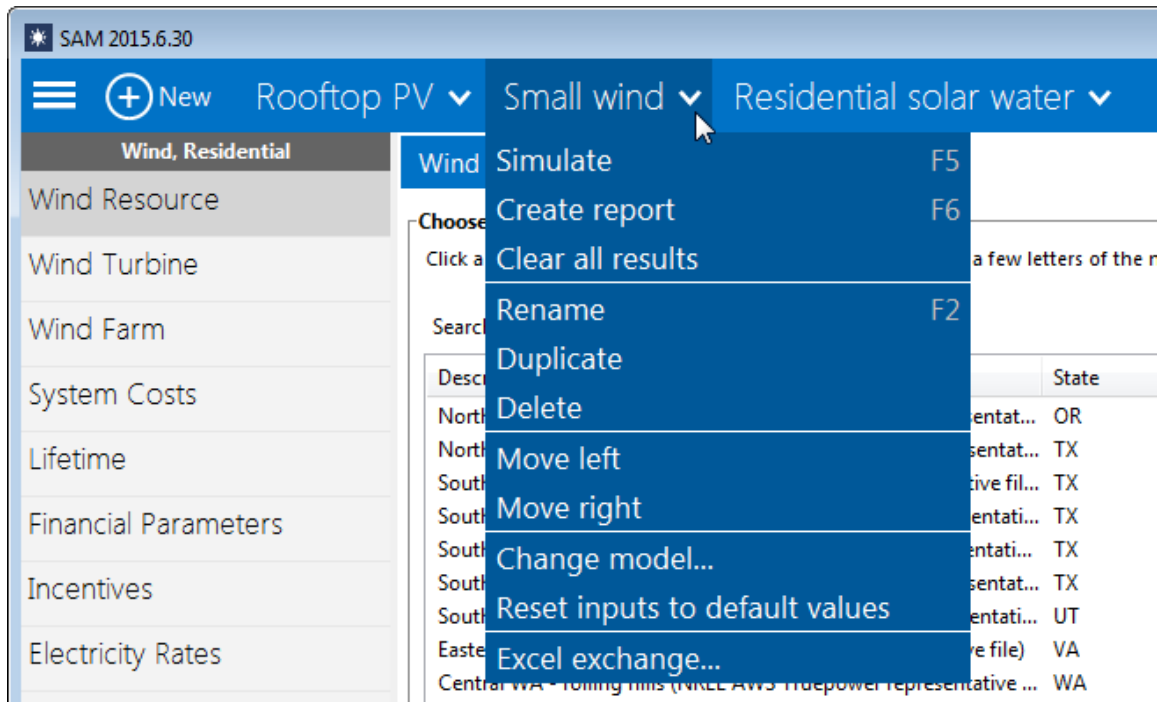
### To create a new case in your file:

- Click New.



### To add, remove, and rename a case:

- Click the  arrow to display the [case menu](#) and click a command.



**Rename**

Change the label identifying the case that appears on the case tab.

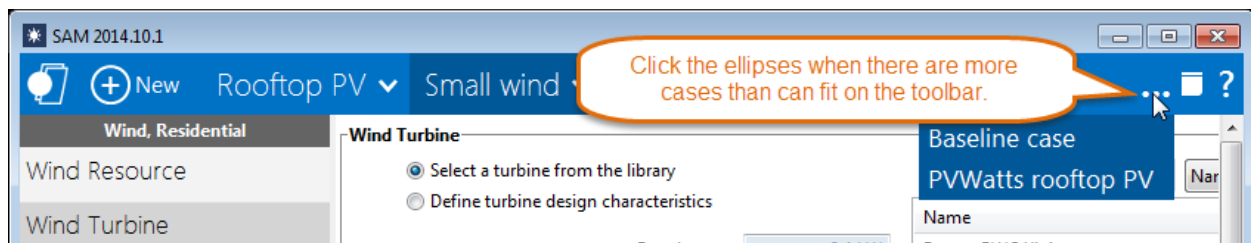
**Duplicate**

Create a copy of the active case, with a duplicate set of input parameters and results.

**Delete**

Delete the active case.

For a file with more cases than can fit on the toolbar, click the ellipses to show a list of cases that do not fit:



## 3.4 Export Data and Graphs

SAM provides several options for exporting data and graph images to other applications for further analysis or inclusion in reports and other documents.

### Input Data

The [Inputs Browser](#) lists all of the input variables for each case in the SAM file, and allows you to compare inputs in the different cases. You can export the data from the browser to a spreadsheet or text file as tab-delimited text.

#### To export input variable values from the Inputs Browser:

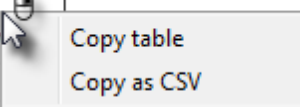
1. Start the Inputs Browser: On the SAM File menu, click **Inputs browser**.
2. Use your mouse to select the variables you want to export: First click a different cell in the table, and then carefully click and hold the cell you want to select. Then drag your mouse to select other variables in the table.
3. Press Ctrl-C to copy the values to your computer's clipboard.
4. Open the spreadsheet or text file to which you want to copy the values.
5. Press Ctrl-V to paste the values.

### Metrics Table Data

You can export data from the [Metrics table](#) by right-clicking it and choosing an option to copy the data to your computer's clipboard, which you can paste into a spreadsheet or other document.

**Note.** You can also use the [Data](#) table (single value) to display and export results variables from the metrics table, and other results that are not shown in the metrics table. For example, you can find the real LCOE in the Data table.

Metric	Value
Annual Energy	37,211,888 kWh
Capacity Factor	21.2%
First Year kWhAC/kWDC	1,861
Performance Ratio	0.817
PPA Price (Year 1)	10.31 ¢/kWh
PPA Price Escalation	1.00 %



#### Copy table

Copies the metrics table to your computer's clipboard with columns separated by tabs.

#### Copy as CSV

Copies the metrics table to your computer's clipboard with columns separated by commas.

## Graph Data and Images

Right-click any graph in SAM to display a shortcut menu of options for exporting graph data or an image of the graph. If your mouse has one button, use Control-click to display the shortcut menu. This works for graphs on input pages and on the Results page.

### To export data:

#### Copy data to clipboard

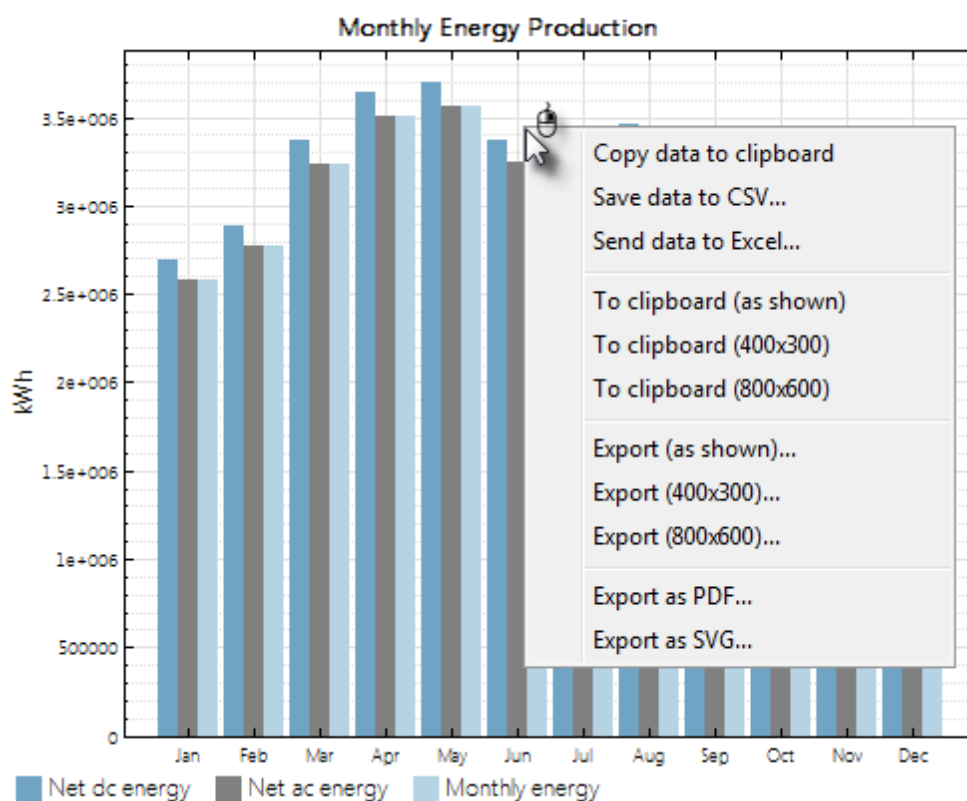
Copies the data visible in the graph to your computer's clipboard. You can then paste the data into another program or document.

#### Save data to CSV

Creates a comma-separated text file containing the data visible in the graph.

#### Send data to Excel

Opens Microsoft Excel with a spreadsheet containing the graph data.



### To export a graph image:

#### To clipboard (as shown/400x300/800x600)

Copy an image of the graph as it appears on the screen or using the given dimensions in pixels to your computer's clipboard.

**Export (as shown/400x300/800x600)**

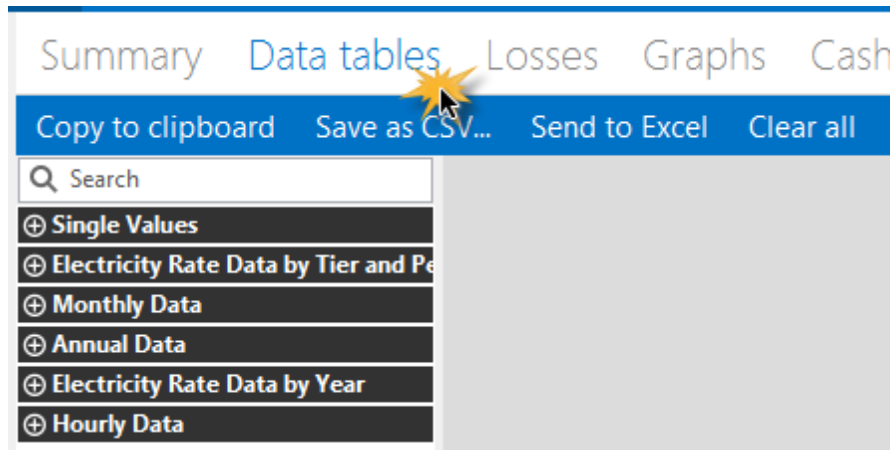
Creates a file of the graph image in BMP, JPG, or PNG format.

**Export as PDF/SVG**

Creates a file of the graph image in PDF or SVG format. This option is best for images that you plan to resize later.

**Table Data**

Use the buttons along the top of the Results page to export data from tables. This works for The [Cash Flows](#) table and [Data Tables](#) provide three options for exporting data shown in the tables:

**Copy to clipboard**

Copies the table to your clipboard. You can paste the entire table into a word processing document, spreadsheet, presentation or other software.

**Save as CSV**

Saves the table in a comma-delimited text file that you can open in a spreadsheet program or text editor.

**Send to Excel**

Saves the table to a Microsoft Excel file. (Use **Copy to clipboard** to export data to a different spreadsheet program.)

## 3.5 Reports

SAM's report generator creates a PDF file that may include the following:

- Values of input and results variables.
- Values calculated for the report using the report generator's equations.
- Graphs of results data.
- Tables of input or results data.
- Text and images.

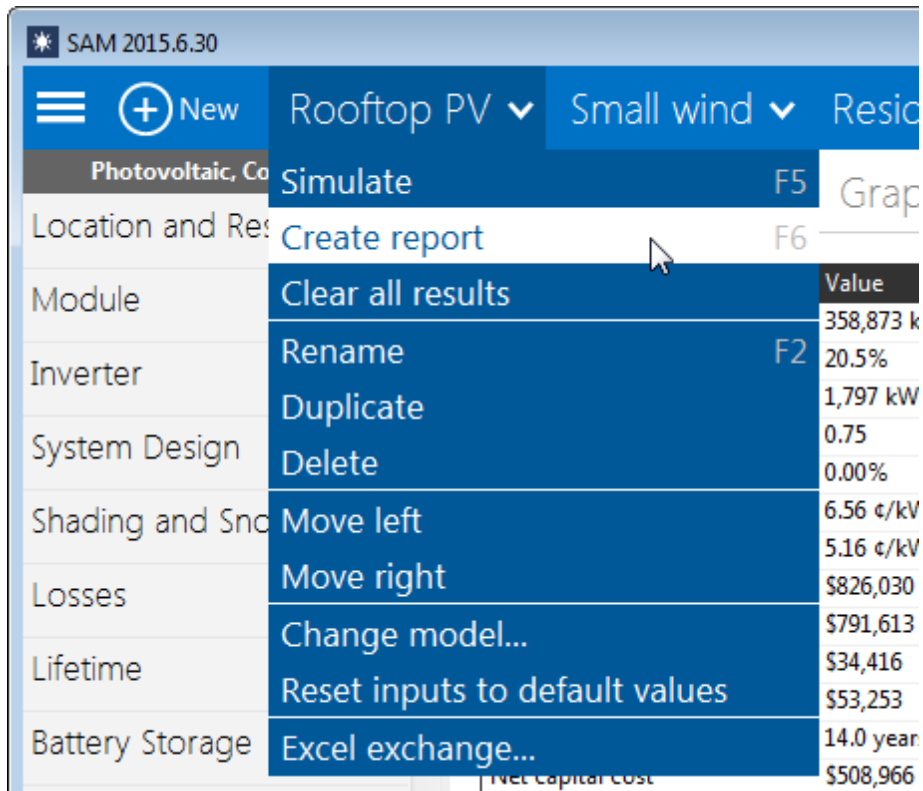
Performance Model		Financial Model	
<div style="display: flex; justify-content: space-between; align-items: center;"> <div style="text-align: center;"> <b>System Advisor Model Report</b>            Photovoltaic System    200 DC kW Nameplate    Phoenix, AZ            Commercial    \$2.53/W Installed Cost    33.43 N, -112.02 E GMT -7         </div> </div>			
<b>Modules</b> SunPower SPR-210-BLK-U Cell material    Mono-c-Si Module area    1.2 m <sup>2</sup> Module capacity    215.3 DC Watts Quantity    508 Total capacity    109.8 DC kW Total area    1,154 m <sup>2</sup>		<b>Project Costs</b> Total installed cost    \$509,573 Salvage value    \$0	
<b>Inverters</b> SMA America: 5136 (240) 240V Unit capacity    36 AC kW Input voltage    250 - 480 VDC DC V Quantity    5 Total capacity    180 AC kW DC to AC Capacity Ratio    1.11 AC losses (%)    1.0		<b>Analysis Parameters</b> Project life    25 years Inflation rate    2.5% Real discount rate    5.2%	
<b>Array</b> Strings    116 Modules per string    8 String voltage (DC V)    0.0 Tilt (deg from horizontal)    33 Azimuth (deg E of N)    180 Tracking    fixed Backtracking    - Rotation limit (deg)    - Shading    no Soiling    yes DC losses (%)    4.4		<b>Project Debt Parameters</b> Debt fraction    100% Amount    \$0 Term    25 years Rate    7.5%	
<b>Performance Adjustment</b> Annual    TBD Year-to-year decline    TBD Hourly factors    TBD		<b>Tax and Insurance Rates (% of installed cost)</b> Federal income tax    25%/year State income tax    7%/year Sales tax    5% Insurance    0.5%/year Property tax (% of assessed val.)    2%/year	
<b>Annual Results (in Year 1)</b> Horizontal solar kWh/m <sup>2</sup> 0 Incident solar kWh/m <sup>2</sup> 0 DC kWh from array    0.000 Net to inverter    399,000 DC kWh Gross from inverter    399,000 AC kWh Net to grid    399,000 AC kWh Capacity factor    0.21 Performance factor    0		<b>Incentives</b> Federal ITC    30% Federal Depreciation 5-yr MACRS State Depreciation    5-yr MACRS	
		<b>Electricity Demand and Rate Summary</b> System delivers power directly to grid (no building load) Arizona Public Service Co Fixed fee: \$39.72/month Monthly fixed TDU demand charge \$0 Monthly fixed demand charge \$0 Tiered rates with three or more rates	
		<b>Results</b> Nominal LCOE    8.0 cents/kWh Net present value    \$-169,400 Payback period    >25 years	

The report generator uses a report template to generate a report using data from the case that you specify. SAM comes with a set of report templates for some combinations of performance and financial models.

**Note.** The report template editor is not supported in the current version of SAM. If you have requests for items that you would like to appear in reports, please post your request on the SAM Support forum at <https://sam.nrel.gov/forum>.

### To generate a report:

1. Open the *.sam* file containing the case or cases from which you want to generate the report.
2. Click the arrow on the case tab, and on the case menu, click **Create report** (or press the F6 key).



3. Type a file name and choose a folder.

## 3.6 Inputs Browser

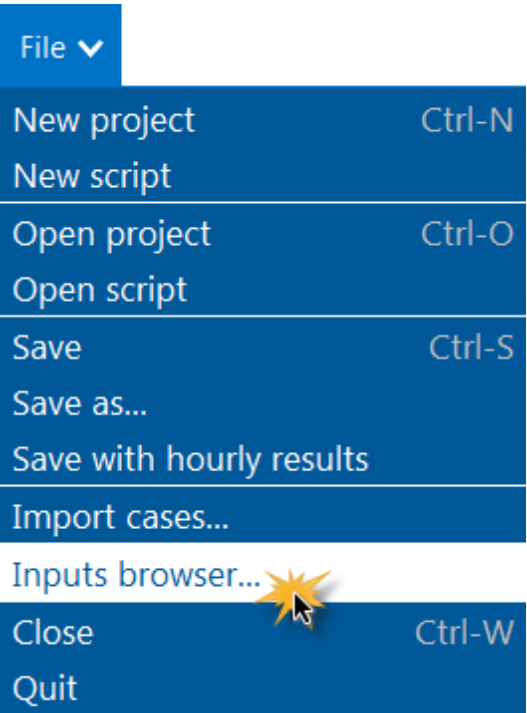
The inputs browser displays a list of the input variables in all cases in the active project. You can use it to:

- Review all of the input values in your project.
- Export a list of all of the inputs and their values.
- Compare inputs in different cases.

For a video demonstrating how to use the inputs browser, see the SAM YouTube channel: <http://www.youtube.com/v/hunpiLH0TFY>

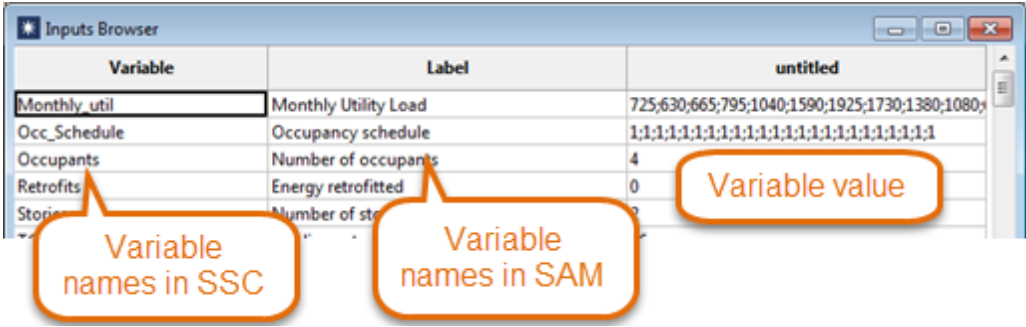
### **To open the inputs browser:**

- On the File menu, click **Inputs Browser**.



### Browsing Inputs for a Single Case

When the active project contains a single case, the inputs browser lists the variables in the case.





## Browsing Inputs for Multiple Cases

Variable	Label	Wind System	Trough System
6par_aisc	Temperature coefficient of Isc		0.00
6par_aisc_units	aisc Temp Coeff Units		A/m²
6par_area	Module area		1.3
6par_bvdc	Temperature coefficient of Voc		-0.1
6par_bvdc_units	bVoc Temp Coeff Units		V/m²

When the project contains more than one case, the inputs browser lists the inputs for each case in the project. You can filter the list to show the following:

### Show different values

List variables that exist in all cases and have different values.

### Show equal values

List variables that exist in all cases and have the same value.

### Show all

List all variables in all cases.

## 3.7 Time Series Data Viewer

The time series data viewer displays graphs of time series data.

**Tip.** SAM's data viewer is also available as a standalone application called DView. You can download it from NREL at <https://beopt.nrel.gov/downloadDView>.

The data viewer is available in SAM from the following input pages:

- [Location and Resource](#) for all solar performance models.
- [Electric Load](#) for the residential and commercial financial models.
- The viewer is also integrated into the [Results](#) page.

### **To open the time series data viewer:**

- Click **View data**.



**To export data or a graph image from the data viewer:**

- Right-click the graph.



## Data Viewer Quick Tips

- For graphs with two columns of check boxes, click a box in the left column of the variable list to display a variable in the top graph. Use the right column to display variables in the bottom graph.
- Each graph can display two types of units, on each on the left y-axis and right y-axis.
- The colors in variable list indicate the line colors in the graph.
- Select a segment of the graph to zoom in.
- Use the controls at the bottom right of the graph to zoom in and out, and to set graph properties like scale limits and line shapes.

## Data Viewer Graph and Table Descriptions

- **Hourly:** Time series data.
- **Daily:** Daily totals
- **Monthly:** Monthly totals
- **Heat map:** Entire time series for a single variable
- **Profile:** Daily averages by month
- **Statistics:** Table of statistics calculated from time series data
- **PDF / CDF:** Histogram showing distribution of time series values for a variable, probability distribution function (PDF) and cumulative distribution function (CDF)
- **Duration Curve:** Graph of time steps equaled or exceeded for a single variable.
- **Scatter:** An x-y scatter plot of two variables in the weather file.

## 3.8 Weekday-weekend Schedule

Weekday and weekend schedule matrices associate time periods with different times of day and months of year for time-of-use or time-of-delivery applications.

To use the matrices, you draw rectangles on the matrix with your mouse, and type a number with your keyboard for the period that applies to the times represented by the rectangles.

SAM arbitrarily defines the first day of time series data (the first 24 hours for hourly data) to be Monday on January 1, and assigns the remaining days of the year accordingly. SAM assumes that weekdays include Monday through Friday, and that weekends include Saturday and Sunday. SAM does not account for holidays or other special days. It also does not account for leap years, and does not include a day for February 29.

### To specify a weekday or weekend schedule:

1. Assign values as appropriate to each of the up to nine periods.
2. Use your mouse to draw a rectangle in the matrix for the first block of time that applies to period 2.

	12am	1am	2am	3am	4am	5am	6am	7am	8am	9am	10am	11am	12pm	1pm	2pm	3pm	4pm	5pm	6pm	7pm	8pm	9pm	10pm	11pm
Jan	1	1	1	1	1	1	1	1	1	1	1	1	1	1	1	1	1	1	1	1	1	1	1	1
Feb	1	1	1	1	1	1	1	1	1	1	1	1	1	1	1	1	1	1	1	1	1	1	1	1
Mar	1	1	1	1	1	1	1	1	1	1	1	1	1	1	1	1	1	1	1	1	1	1	1	1
Apr	1	1	1	1	1	1	1	1	1	1	1	1	1	1	1	1	1	1	1	1	1	1	1	1
May	1	1	1	1	1	1	1	1	1	1	1	1	1	1	1	1	1	1	1	1	1	1	1	1
Jun	1	1	1	1	1	1	1	1	1	1	1	1	1	1	1	1	1	1	1	1	1	1	1	1
Jul	1	1	1	1	1	1	1	1	1	1	1	1	1	1	1	1	1	1	1	1	1	1	1	1
Aug	1	1	1	1	1	1	1	1	1	1	1	1	1	1	1	1	1	1	1	1	1	1	1	1
Sep	1	1	1	1	1	1	1	1	1	1	1	1	1	1	1	1	1	1	1	1	1	1	1	1
Oct	1	1	1	1	1	1	1	1	1	1	1	1	1	1	1	1	1	1	1	1	1	1	1	1
Nov	1	1	1	1	1	1	1	1	1	1	1	1	1	1	1	1	1	1	1	1	1	1	1	1
Dec	1	1	1	1	1	1	1	1	1	1	1	1	1	1	1	1	1	1	1	1	1	1	1	1

3. Type the number 2.

	12am	1am	2am	3am	4am	5am	6am	7am	8am	9am	10am	11am	12pm	1pm	2pm	3pm	4pm	5pm	6pm	7pm	8pm	9pm	10pm	11pm
Jan	1	1	1	1	1	1	1	1	1	1	1	1	1	1	1	1	1	1	1	1	1	1	1	1
Feb	1	1	1	1	1	1	1	1	1	1	1	1	1	1	1	1	1	1	1	1	1	1	1	1
Mar	1	1	1	1	1	1	1	1	1	1	1	1	1	1	1	1	1	1	1	1	1	1	1	1
Apr	1	1	1	1	1	1	1	1	1	1	1	1	1	1	1	1	1	1	1	1	1	1	1	1
May	1	1	1	1	1	1	1	1	1	1	2	2	2	2	2	2	1	1	1	1	1	1	1	1
Jun	1	1	1	1	1	1	1	1	1	1	2	2	2	2	2	2	1	1	1	1	1	1	1	1
Jul	1	1	1	1	1	1	1	1	1	1	2	2	2	2	2	2	1	1	1	1	1	1	1	1
Aug	1	1	1	1	1	1	1	1	1	1	2	2	2	2	2	2	1	1	1	1	1	1	1	1
Sep	1	1	1	1	1	1	1	1	1	1	1	1	1	1	1	1	1	1	1	1	1	1	1	1
Oct	1	1	1	1	1	1	1	1	1	1	1	1	1	1	1	1	1	1	1	1	1	1	1	1
Nov	1	1	1	1	1	1	1	1	1	1	1	1	1	1	1	1	1	1	1	1	1	1	1	1
Dec	1	1	1	1	1	1	1	1	1	1	1	1	1	1	1	1	1	1	1	1	1	1	1	1

4. SAM shades displays the period number in the squares that make up the rectangle, and shades the rectangle to match the color of the period. Each time period may represent a time-of-use period for retail electricity pricing, time-of-delivery period for PPA price multipliers, a period for storage dispatch, or other time-dependent feature.

Payment

Allocation

Factor

Period 1:

Period 2:

Period 3:

Period 4:

**Weekday Schedule**

	12am	1am	2am	3am	4am	5am	6am	7am	8am	9am	10am	11am	12pm	1pm	2pm	3pm	4pm	5pm	6pm	7pm	8pm	9pm	10pm	11pm
Jan	1	1	1	1	1	1	1	1	1	1	1	1	1	1	1	1	1	1	1	1	1	1	1	1
Feb	1	1	1	1	1	1	1	1	1	1	1	1	1	1	1	1	1	1	1	1	1	1	1	1
Mar	1	1	1	1	1	1	1	1	1	1	1	1	1	1	1	1	1	1	1	1	1	1	1	1
Apr	1	1	1	1	1	1	1	1	1	1	1	1	1	1	1	1	1	1	1	1	1	1	1	1
May	1	1	1	1	1	1	1	1	1	1	2	2	2	2	2	2	1	1	1	1	1	1	1	1
Jun	1	1	1	1	1	1	1	1	1	1	2	2	2	2	2	2	1	1	1	1	1	1	1	1
Jul	1	1	1	1	1	1	1	1	1	1	2	2	2	2	2	2	1	1	1	1	1	1	1	1
Aug	1	1	1	1	1	1	1	1	1	1	2	2	2	2	2	2	1	1	1	1	1	1	1	1
Sep	1	1	1	1	1	1	1	1	1	1	1	1	1	1	1	1	1	1	1	1	1	1	1	1
Oct	1	1	1	1	1	1	1	1	1	1	1	1	1	1	1	1	1	1	1	1	1	1	1	1
Nov	1	1	1	1	1	1	1	1	1	1	1	1	1	1	1	1	1	1	1	1	1	1	1	1
Dec	1	1	1	1	1	1	1	1	1	1	1	1	1	1	1	1	1	1	1	1	1	1	1	1

**Weekend Schedule**

	12am	1am	2am	3am	4am	5am	6am	7am	8am	9am	10am	11am	12pm	1pm	2pm	3pm	4pm	5pm	6pm	7pm	8pm	9pm	10pm	11pm	
	E												E	E	E									E	E

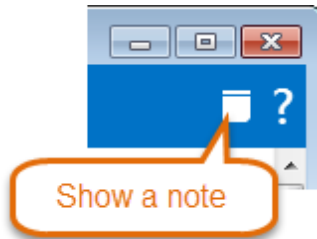
- Repeat Steps 2-4 for each of the remaining periods that apply to the schedule.

### 3.9 Notes

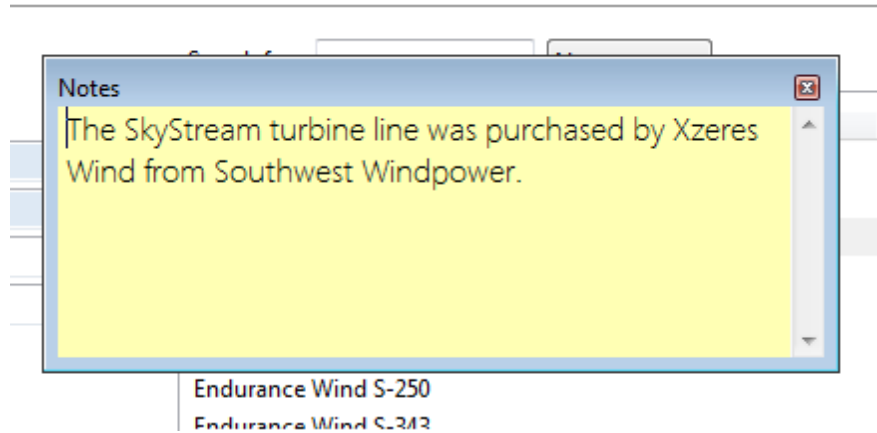
The Notes feature allows you to store text associated with each input page and with the Results page.

**To create notes:**

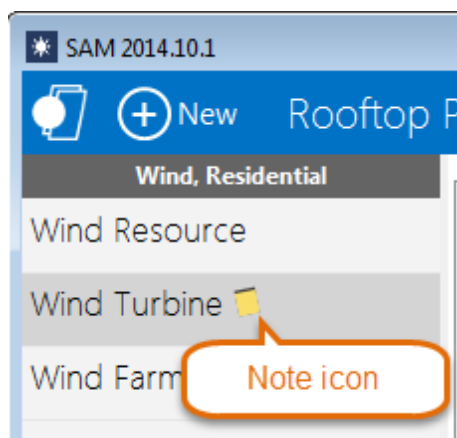
- On any input page or the Results page, click the Show Note button at the top right of the window.



- Type your text in the Notes window.



You can click the Notes window's close button to hide the window and save your notes. For input pages with a note, SAM displays a Note icon in the navigation menu indicating that there are notes associated with the input page.



For Results page notes, SAM creates a separate note for each tab (Summary, Graphs, etc.).

#### **To delete a note:**

1. Open the Notes window you want to delete.
2. Use your mouse to select all of the text in the note press the Delete key.
3. Close the Notes window by clicking the 'x' in the window's top right corner. SAM will remove the appropriate Note icon from the navigation menu.

## **3.10 Excel Exchange**

Excel Exchange allows you to link any input variable in SAM to a cell or range of cells in a Microsoft Excel workbook. This feature allows you to use an external spreadsheet-based model to generate values for SAM input variables. SAM can both import input variable values from an Excel worksheet and export input variable values to the worksheet.

Using Excel Exchange involves the following steps:

- Prepare an Excel workbook for the data exchange.
- In SAM, configure and turn on Excel Exchange.
- In SAM, [run a simulation](#). SAM exchanges data with the Excel workbook during the simulation.

For an example of SAM with Excel Exchange, download the files *excel-exchange-example.sam* and *excel-exchange-example.xlsx* from the [Sample Files collection](#) in the SAM GitHub repository. To run it, place both files in the same folder on your computer, open the SAM file, and run a simulation.

#### Notes.

Excel Exchange is designed to allow you to read values of SAM *input* variables from an Excel workbook. You cannot use Excel Exchange to write values of SAM results to a workbook. If you want to export results to Excel, you can use one of the options described in [Export Data and Graphs](#), or you can write a [script](#) to export SAM results.

Excel Exchange works in the Windows version of SAM and requires that Microsoft Excel be installed on your computer. It will not work with other spreadsheet software or in the Mac or Linux versions of SAM.

When SAM runs with Excel Exchange turned on, it exchanges data with a copy of the Excel file in computer memory that you cannot see. It does not modify the file stored on your computer's disk, so you will not see any changes in the workbook values.

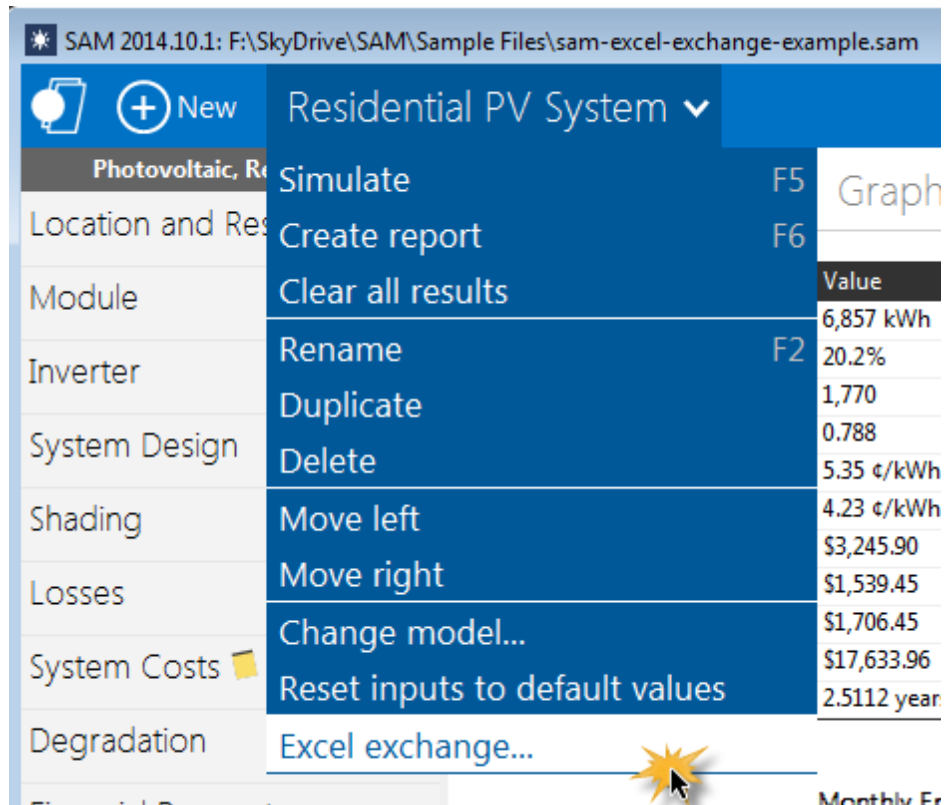
If the Excel workbook contains more than one worksheet, SAM can only exchange data with the first worksheet (the worksheet whose tab appears on the leftmost tab).

#### **To prepare an Excel workbook for Excel Exchange:**

- Create an Excel workbook with the calculations you want to perform in Excel. Use the first worksheet in the workbook for the data exchange.
- Identify the cells or cell ranges you plan to use for the data exchange. You can refer to them using either ranges (module\_cost, NameplateCapacity, etc.) or cell references (A1, C15, etc.).
- For SAM input variables with multiple values specified in SAM using an [annual schedule](#), use the cell reference notation (A1:A12, B15:G15, etc.) rather than a named range.

#### **To configure and turn on Excel Exchange:**

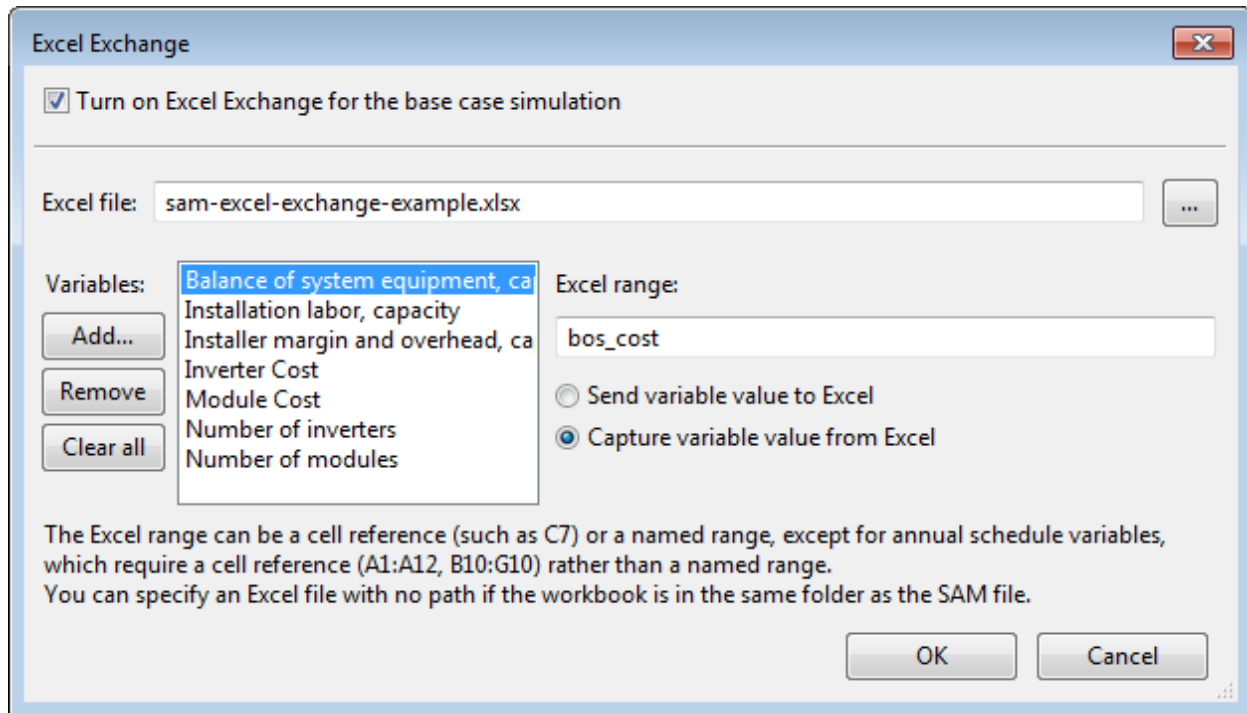
1. Create or open the SAM file you want to configure for Excel Exchange.
2. Save the file.
3. On the [case menu](#), click **Excel Exchange**.



4. In the Excel Exchange Window, check **Turn on Excel Exchange for the base case simulation** to active Excel Exchange. You can clear the check box to keep the Excel Exchange configuration without running the Exchange when you run a simulation.
5. For **Excel file**, click the  browse button and choose the Excel file you want to use for the exchange. You can remove the file path if you plan to keep the Excel and SAM files in the same folder.
6. In the **Variables** list, add the SAM variables you want to use for the data exchange: Click **Add** to open the input variable browser.
7. For each variable in the list, click its name, and
  - a. For **Excel range**, type either the cell reference (A1, C10, etc.) or range name (module\_cost, NameplateCapacity, etc.) of the workbook cell or range associated with the SAM variable. Do not enclose the references or names in quotes.
  - b. Click **Send variable value to Excel** if you want to send that variable's value to the Excel workbook, or **Capture variable value from Excel** if you want to read that variable's value from the Excel workbook.
8. Click **OK**.
9. Click **Simulate** to run a simulation with Excel Exchange.



## Excel Data Exchange Reference



### Turn on Excel Exchange for the base case simulation

Check the box to turn on the data exchange.

You can clear the box to keep the Excel Exchange configuration without exchanging data when you run a simulation.

### Excel file

The name of the Excel workbook for the data exchange.

If you plan to keep the Excel file in the same folder as the SAM file (.sam), you do not need to include a path in the file name. Use this option if you plan to share the file with someone else, or copy the files to different computers.

### ... Browse

Browse your computer's folders to find the Excel workbook with which you want to exchange data. The workbook can be located in any folder on your computer.

### Add

Add one or more input variable from the input pages. You can configure each variable to either send a value to an Excel range, or "capture" a value from an Excel range.

### Remove

Delete the highlighted variable from the list.

### Clear All

Delete all variables from the list.

### Excel Range

The range name or cell reference identifying the cell or range of cells in the Excel workbook with which the highlighted variable will exchange data.

### Send Variable Value to Excel Range

Configure the highlighted variable to send its value to the specified range in the Excel workbook.

### Capture Variable Value From Excel Range

Configure the highlighted variable to capture its value from the specified Excel range.

## 3.11 Libraries

A library is a text file of comma-separated values that stores sets of data associated with a SAM input in the *libraries* folder of your SAM installation folder. SAM displays the library contents in a [library browser](#) where you choose an item from the library to populate values of a set of input variables. For example, the detailed photovoltaic model uses a library to store inverter parameters. By choosing an inverter name, you populate the 16 input variables required to specify an inverter using the CEC inverter model.

**Note.** In addition to the parameter libraries shown in the table below, SAM also creates libraries as temporary files on your computer to store information about your wind and solar resource data files. For more about weather file libraries, see [Weather Files and Libraries](#).

Name	Description	Model	Source
CEC Inverters	Photovoltaic inverters	Detailed photovoltaic	Go Solar California
CEC Modules	Photovoltaic modules	Detailed photovoltaic	Go Solar California
Empirical Trough HCEs	Parabolic trough receivers	Empirical trough	NREL
Empirical Trough Power Cycles	Power block parameters for parabolic trough	Empirical trough	NREL
Empirical Trough SCAs	Parabolic trough collectors	Empirical trough	NREL
Physical Trough Collectors	Parabolic trough collectors	Physical trough	NREL
Physical Trough Receivers	Parabolic trough receivers	Physical trough	NREL
Sandia Modules	Photovoltaic modules	Detailed photovoltaic	Sandia National Laboratories
SRCC Collectors	Solar water heating collectors	Solar water heating	Solar Rating and Certification Corporation
TOD Schedules and Factors	PPA price multipliers	All PPA financial models	NREL
Trough Parasitics	Parabolic trough parasitic loads	Empirical trough	NREL
Wind Turbines	Wind turbine power curves	Empirical trough	NREL

### Choosing Items from a Library

SAM displays library items in a list. To choose an item from the library, click a row in the list. Depending on the input page, SAM either populates the associated input variables with values from the library, or applies the values after you click an **Apply Values from Library** button.

Heat Collection Element (HCE) / Receiver Library

Search for:  Name

Name	Broken	Bellows	Transmissi...	Absorption	Unaccount...	A0	A1	A2
Schott PTR70 Vacuum	0	0.963	0.963	0.96	1	1.86	0.18741	-0.0011594
Schott PTR70 Lost Vacuum	0	0.963	0.963	0.96	1			
Schott PTR70 Hydrogen	0	0.963	0.963	0.96	1			
Luz Cermet Vacuum	0	0.971	0.935	0.925	1			
Luz Cermet Lost Vacuum	0	0.971	0.935	0.925	1			
Luz Cermet Hydrogen	0	0.971	0.935	0.925	1	1.0255	1.2752	0.0015105
Luz Cermet/Fluorescent	0	0.971	0.7	0.8	1	0.64628	0.82543	-0.00014146
Solel UVAC2 Vacuum	0	0.971	0.96	0.96	1	1.8615	0.18741	-0.0011594
Solel UVAC2 Lost Vacuum	0	0.971	0.96	0.96	1	-0.16634	0.87716	-0.00075942
Solel UVAC2 Hydrogen	0	0.971	0.96	0.96	1	9.2419	1.3648	0.0010516
Solel UVAC2 Vacuum	0	0.971	0.96	0.96	1	0.5751	0.1135	0.0008

## Modifying Libraries

For most applications, you do not need to modify libraries. However, if you have reason to modify a library, you can easily do so by editing the library file with a text editor or spreadsheet program.

**Note.** If you modify a library, do not change the first three rows of the library file.

The library file format is defined as follows:

- Library files use the .csv file name extension and are stored in the *Libraries* folder of your SAM installation.
- The first row of a library file is a list of the labels describing the input variables stored in the library. SAM displays these labels in the library browser. It does not use these labels in calculations.
- The second row is a list of units for each variable in the library that SAM displays in the library browser. SAM does not use the units in calculations.
- The third row is a list of SSC variables in the library. Do not change these values because SAM uses them to identify the values in the library.
- The fourth row is the set of parameters for the first item in the library.

### To add an item to a library:

1. In the *Libraries* folder, open the library you want to modify with a text editor or spreadsheet program. Use the table above to find the library's name.
2. Add your item after the last row of the library. Be sure to use the same units and conventions as the other items in the library.

## 3.12 Macros and Scripting

An LK script is code that you write in a SAM file to automate assigning values to SAM inputs, running simulations, and reading and writing SAM results. A macro is an LK script packaged with SAM that you run from the Macros page.

### Running Macros

SAM comes with a set of LK scripts packaged as macros. Macros are designed to allow you to run scripts without having to write it.

#### To run a macro:

- Click Macros.

The screenshot illustrates the process of running a macro in SAM. It shows the 'Simulate' menu with 'Macros' selected. A list of macros is displayed, including 'Auxiliary Gas Heater'. The 'Auxiliary Gas Heater' macro is selected, showing its description and input fields. The 'Run macro' button is highlighted. The console window at the bottom displays the results of the simulation.

1. Click **Macros** to show a list of macros available for the case.

2. Click a macro's name to see its description and inputs.

3. Review and change the macro's inputs.

4. Click **Run macro** to start it.

5. Check the console for messages and results. Some macros display results in a separate window.

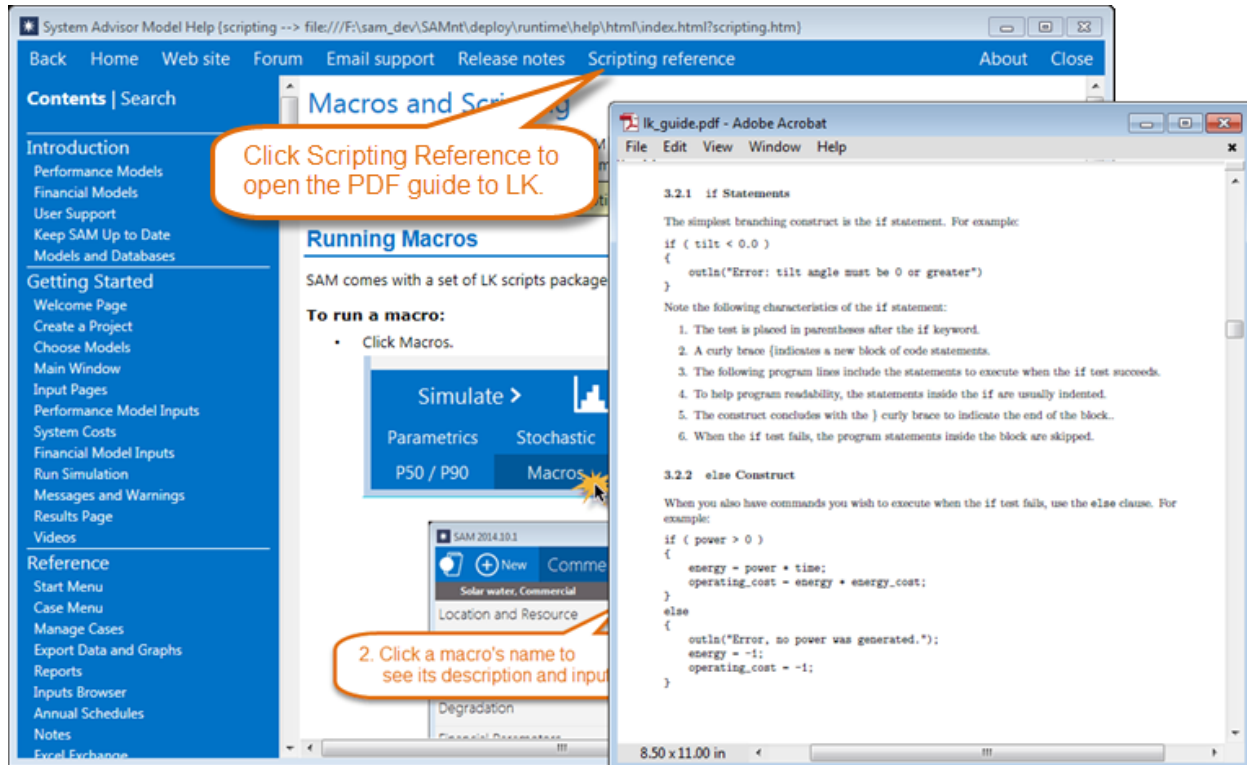
### Creating and Editing Scripts

You can write your own LK scripts to automate SAM analysis tasks:

- Set values of inputs.
- Run simulations.
- Read results.

- Read and write data from text files.
- Create Microsoft Excel objects to exchange data with Excel workbooks.
- Create graphs.
- Interact with the internet.
- Run SSC modules directly. (See [Software Development Kit.](#))

For a complete reference to the LK scripting language, click **Scripting reference** above:

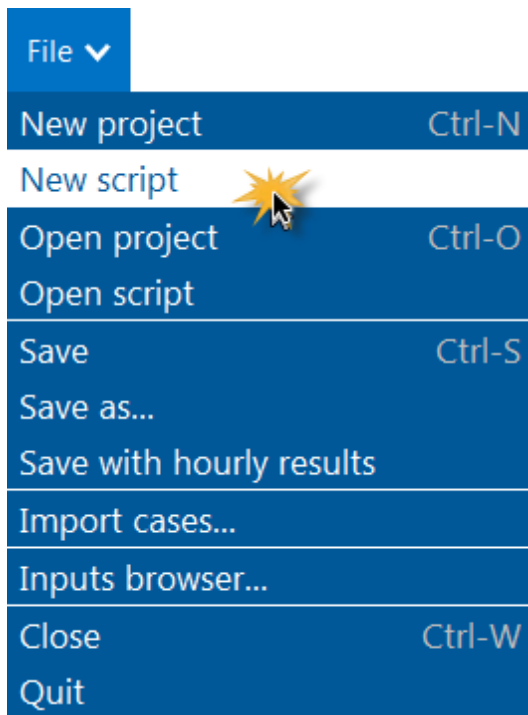


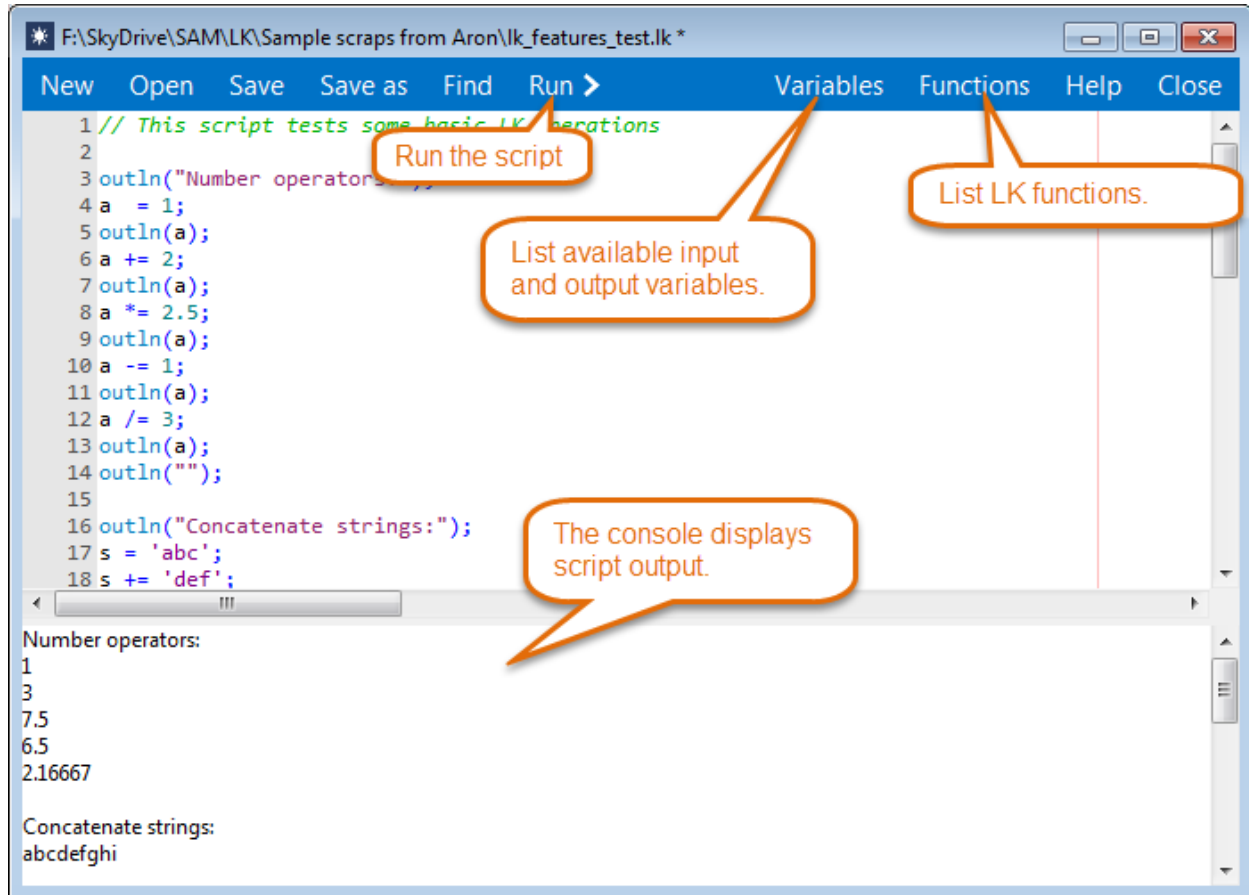
LK Script notes:

- When you save the script, SAM stores it in a text file with the `.lk` extension.
- LK script files are separate from SAM files.
- The LK scripting language is also part of the [SAM software development kit \(SDK\)](#).
- For examples of LK scripts, see [LK Scripts for SAM](#) on the SAM GitHub repository.

**To create or open an LK script:**

- On the File menu click **New script** or **Open script**.





## Running Scripts from the Command Line

You can run a script from the command line in a Command or Terminal window. The syntax is:

```
[ path to SAM executable ] [ any string ] [ path to .lk script file ]
```

Note the spaces between each parameter.

For example, in Windows, the command might look like this:

```
c: / sam / 2020. 2. 29 / x64 / sam exe not - a - sam file c: / test . lk
```

The command starts the SAM desktop application, opens the .lk file in a script editor and runs the script (equivalent to clicking the Run button in the script editor). The middle parameter is required (it can be any string), but does not do anything. You have to manually close SAM when you are finished.

You can also use the following to open a .sam file from the command line:

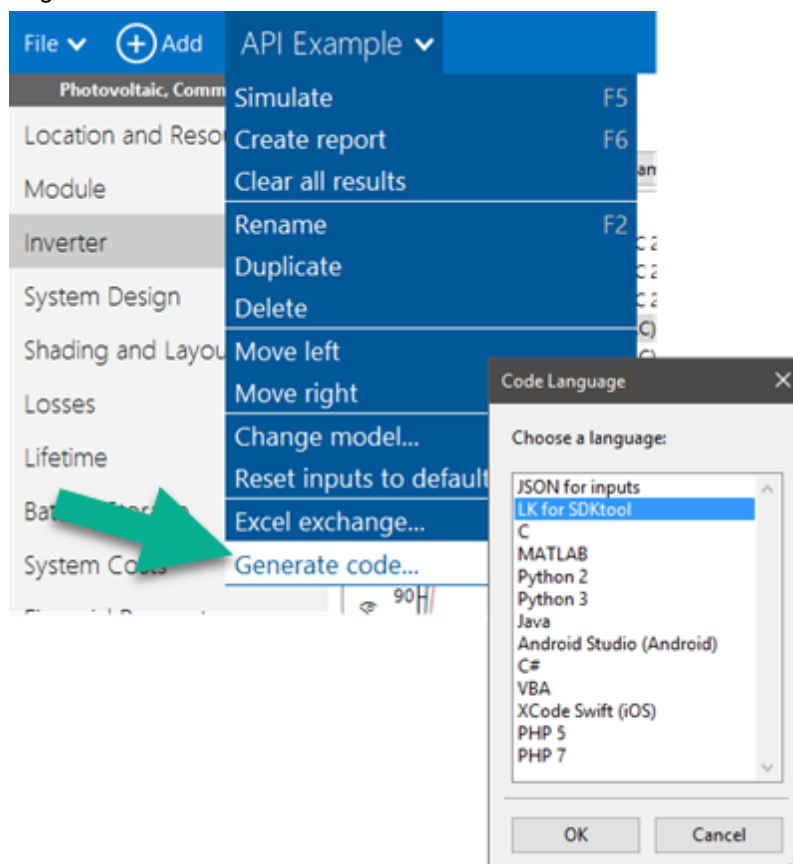
```
[ path to SAM executable ] [ path to .sam file ]
```



### 3.13 Software Development Kit

The SAM software development kit (SDK) is a collection of developer tools for creating renewable energy system models using an application programming interface (API) that provides access to the SAM Simulation Core (SSC):

- The SSC API provides access to SSC, which is a library of modules for modeling renewable energy projects.
- SDKtool is a program that comes with your SAM installation to explore SSC. It includes a module browser that can run individual SSC modules, a data container that displays editable lists of module inputs and outputs, and a script editor where you can test your algorithms in the LK scripting language.
- The SSC Guide is a user manual for the SDK.
- SAM's code generator generates creates a ready-to-run program written in one of various languages with supporting libraries and data files from the information in a SAM case.



#### **To get started with the SDK:**

1. Download the SSC Guide from the [SDK page](#) on the SAM website.
2. In your SAM installation folder, find the SDKtool application. It should be in the same folder as the SAM application (for example, in Windows, c:/SAM/2020.11.29/x64/sdktool.exe).
3. Start SAM, and create or open a project for the kind system you would like to model.

4. On the [Case menu](#), click **Generate Code**, or press Shift+F5.
5. Choose a language to export the code.
6. Navigate to the folder where you want to save the file(s). For some cases or languages, SAM will save a set of files, so you may want to create a new folder to make it easier to find the files.

## 3.14 File Formats

SAM uses the following types of files to store and transfer data. The file formats are listed below by file extension in alphabetical order.

### **BMP**

Graphics file format used to export graph images.

### **CSV**

Text file containing a table of comma-delimited columns that SAM uses to export results data from graphs and tables, store library data, and for [weather files](#).

### **EPW**

EPW weather file format for EnergyPlus weather files.

### **JPG**

Graphics file format used to export graph images.

### **LK**

Text file containing [LK script](#) for automating SAM analyses.

### **PNG**

Graphics file format used to export graph images.

### **SAM**

File format for SAM project files. Stores inputs and results.

### **SAMREPORT**

File format used to store [report](#) templates.

### **SRW**

Text file containing [wind resource](#) data for the wind power model.

### **TM2**

Weather file in the TMY2 format from the NSRDB.

### **XLSX**

Excel files used to [export data](#) from SAM and to [exchange data](#) between the model and Excel.

### **ZSAM**

An obsolete file format for SAM project files (SAM 2014.1.14 and earlier). SAM cannot import files in the .zsam format.

## 3.15 Software Installation

To install SAM, download the package for your computer's operating system from the [SAM website's Download page](#), and follow the installation instructions.

### System Requirements

SAM runs on most recent versions of Windows, Mac, and Linux operating systems. For information about requirements for different versions of SAM, see [SAM website Download page](#). SAM requires an internet connection for [registration](#) and [access to online databases](#).

### SAM Installation Folder

Your SAM installation contains the SAM executable file and supporting files and folders. You may need to access the SAM installation to find resource data files, SAM libraries, or to [remove SAM](#) from your computer. Be careful not to modify, move, or delete any files in the folder unless you understand how SAM uses the file.

The SAM installation folder is the folder that contains the SAM executable and its supporting files:

#### Windows:

- By default, the SAM installation is in `c:\SAM2020.11.29`, although you can install SAM in any folder on your computer.

#### Mac:

- On a Mac, the SAM installation is the SAM application bundle, which is distributed on a disk image named `sam-osx-November 20, 2020.dmg`.
- SAM runs directly from the disk image, which can be in the Applications folder, desktop, or other folder on your computer.
- To open the application bundle, in Finder, control-click (or right-click) the SAM name and click **Show Contents**. If SAM is in your Applications folder, command-click the name to open it in Finder.

#### Linux

- In Linux, SAM installs by default in `home/<user>/SAM/2020.11.29`, although you can install SAM in any folder on your computer.

### Removing SAM from your computer

When you install a new version of SAM or no longer need the software, you can remove it from your computer:

#### Windows

1. In the Windows Control Panel, under **Programs**, click **Uninstall a Program** (*Control Panel\Programs\Programs and Features*), and select the SAM version you want to uninstall from the list. The SAM program is listed as SAM <version number>.
2. Click **Uninstall**.

**Note.** Any files in the [SAM installation folder](#) that you added or modified are not removed by the uninstall process. You can safely delete the folder if you do not need those files.

### OS X

- Drag the SAM application bundle to the Trash.

### Linux

- Open a terminal window and run `rm -rf /path/to/SAM/2020.11.29`.

## Running multiple versions of SAM

You can keep different versions of SAM installed on your computer and run them simultaneously as separate pieces of software. When you install a new version of SAM, unless you install it in the same folder as another version of SAM, it installs as a separate installation. You may want to keep multiple versions of SAM on your computer to compare results between versions or if your work with SAM requires that you use a specific version.

## Installing SAM in a laboratory environment

If you are installing SAM on more than one computer in a teaching laboratory or other setting, please [email us](#) for instructions to register the entire laboratory with a single key.

## 3.16 Registration

When you start SAM for the first time, you must provide an email address to receive a registration key and activate your copy of SAM. Your registration key is associated with the email address you provide when you register your copy of SAM. The email address must be valid and for an account that you can access to ensure you receive the registration key.

- NREL provides SAM registration keys for free.
- You receive your registration key by email. Be sure to keep the email or a copy of the key so you can register new versions, or in case you need to re-register SAM.
- The registration key works with both the Windows and OS X versions of SAM.
- You can use your registration key to register SAM on more than one computer.

**Note.** If your computer is connected to the internet and you have trouble registering or verifying your key, please see [Web Access and Proxies](#) for information that you might need to troubleshoot the issue.

### To register your copy of SAM:

1. Install SAM and start the software.  
SAM displays the registration window. If it does not, you can display it by clicking **Registration** in the bottom left corner of the [Welcome page](#).
2. In the registration window, type your email address and click **Register**.  
Within a few minutes, you should receive a registration key by email from [sam.support@nrel.gov](mailto:sam.support@nrel.gov).
3. Cut and paste the key from the email into the Registration window.
4. Click **Confirm**.  
SAM displays a message about registration.

5. Click **OK** to agree to share information about your use of SAM and register SAM, or click **Cancel** to stop the registration process.

## Your personal data and SAM

When you register SAM, you provide NREL with your email address, which SAM sends via secure connection (HTTPS), and which NREL stores in a secure database on NREL servers.

After registering SAM, each time you start SAM, it verifies your registration key, and sends the following data to the registration database, where it is stored permanently, and can be accessed by NREL staff:

- Your computer's IP address, which provides approximate location information about your computer
- The name of the SAM application and its version number.
- The date and time you registered each version of SAM.
- The date and time you last started each version of SAM.
- The number of times you started each version SAM.

NREL uses this data to determine how many people are using different versions of SAM, and approximately where people are using the software. This information helps the laboratory demonstrate SAM's value to the U.S. Department of Energy and other sponsors who fund its development, and makes it possible for you to use it for free.

## Using SAM while off line

When you start SAM while your computer is not connected to the internet, SAM cannot verify your registration key, so it displays the registration window with an option to "skip for now." Use this option to run SAM while your computer is off line. You can run SAM off line, but you will not be able to download weather data, electricity rate data, or other data from online databases. SAM allows you to run your copy of SAM up to 15 times without verifying the registration key. The next time you start SAM while connected to the internet, after it successfully connects to the registration database, it restores the number of times you can skip registration to 15.

### To run SAM while your computer is offline:

1. Start SAM.
2. In the registration window, click **Close**.
3. Read the verification message, and click **Skip for now**.

**Tip.** If you plan to work offline for an extended period of time during a trip or for another reason, keep SAM open on your computer to avoid using up the number of starts allowed without verifying your registration key. If you use a hibernate or sleep mode to shut down your computer, you can keep SAM open over multiple work sessions.



## Requesting a Registration Key

If you lose your registration key, you can have it resent to your email address.

### To request a registration key:

1. Start SAM. If the registration window does not appear, click **Registration** in the bottom left corner of the [Welcome page](#).
2. Type the email address you first used to register SAM.
3. Click **Register** without typing a key.
4. Click **Resend key**.

Within a few minutes, you should receive a registration key by email from [sam.support@nrel.gov](mailto:sam.support@nrel.gov).

## SAM registration and the SAM Website

The SAM registration system is separate from the [SAM website](#) registration system. You do not need to register on the SAM website to download the current versions of SAM.

You do need to register on the SAM website to post questions and comments on the SAM support forum, or to download older versions of the software.

## 3.17 Web Access and Proxies

SAM uses your computer's default internet access settings to communicate with websites using either the HTTP or HTTPS communications protocols. SAM communicates with websites to download weather files, electricity rate data, to display information from or hypertext links from the SAM website, and to [collect software usage data](#).

### Website Addresses

The following is a list of all of the URLs that SAM may use:

```
https://sam.nrel.gov/sites/default/files/content/mobile/android/readme.html
https://sam.nrel.gov/support
https://sam.nrel.gov/sites/default/files/content/mobile/ios/readme.html
https://developer.nrel.gov/api/nsrdb_api/solar/nsrdb_puerto_rico_download.csv?
  api_key=<SAMAPIKEY>&email=<USEREMAIL>
https://developer.nrel.gov/api/nsrdb_api/solar/nsrdb_puerto_rico_download.json?
  api_key=<SAMAPIKEY>&email=<USEREMAIL>
https://developer.nrel.gov/api/nsrdb/v2/solar/nsrdb-data-query.json?
  &api_key=<SAMAPIKEY>&email=<USEREMAIL>&wkt=POINT(<LON>%20<LAT>)
https://developer.nrel.gov/api/sam/v1/tracker
https://sam.nrel.gov/sites/default/files/content/updates/messages.html
https://samrepo.nrelcloud.org/updates/welcome.lk
https://nrel.github.io/SAM/doc/releasenotes.html
https://developer.nrel.gov/api/reopt/v1/job/<RUN_UUID>/results/?api_key=<SAMAPIKEY>
https://developer.nrel.gov/api/reopt/v1/job?format=json&api_key=<SAMAPIKEY>
mailto:sam.support@nrel.gov
https://en.openei.org/w/index.php?title=Special%3AAsk&q=%5B%5BCategory%3AUtility+Companies%
  5D%5D%5B%5BEiaUtilityId%3A%3A<EIAID>%5D%5D&po=%3FEiaUtilityId%0D%0A&eq=yes&p
  %5Bformat%5D=json
https://developer.nrel.gov/api/utility_rates/v3.json?api_key=<SAMAPIKEY>&address=<ADDRESS>
https://api.openei.org/utility_companies?
  version=3&format=json&api_key=<SAMAPIKEY>&scope=<SCOPE>
https://api.openei.org/utility_rates?
  version=7&format=json&limit=<LIMIT>&detail=<DETAIL>&offset=<OFFSET>&ratesforutility=<UTILI
  TYNAME>&getpage=<GUID>&api_key=<APIKEY>
https://en.openei.org/apps/IURDB
https://sam.nrel.gov
https://developer.nrel.gov/api/wind-toolkit/wind/wtk_srw_download?
  year=<YEAR>&lat=<LAT>&lon=<LON>&hubheight=<HUBHEIGHT>&api_key=<SAMAPIKEY>&em
  ail=<USEREMAIL>
```

## Proxy Server Configuration

If your organization uses a web proxy server to connect to the internet, and you are having trouble registering SAM or accessing online databases from SAM, you may need to create a proxy configuration file. The file is a one-line text file with one proxy server address and an optional custom port.

### **To create a proxy configuration file:**

1. Start SAM.
2. When you see the registration window, click Proxies.
3. Type the your organization's web proxy server address. For example if the proxy server address is "proxy-server.myorganization.org", type:

```
proxy-server.myorganization.org
```

To specify a custom port, add it to the name with a colon separator (no spaces). For example, if the custom port number is 9142:

```
proxy-server.myorganization.org:9142
```

The next time you start SAM, it will use the proxy server address to access the internet. You can ch

SAM stores this proxy address in a text file named *proxy.txt* in the [SAM installation folder](#). It contains a single line with the proxy server address and optional custom port.

If you use your computer with different internet connections, and not all connections use a proxy server, or they use different proxy servers, you can change the proxy configuration by following the steps above. Delete the proxy server address to connect directly with no proxy server.



## 3.18 Keyboard Shortcuts

The keyboard shortcuts provide access to functions that are available from the [File menu](#) or the [Case menu](#) and some special functions that are only accessible via a shortcut.

Shortcut	Menu Command	Function
F1		Open Help system.
F2	Case, Rename	Rename case.
F5	Case, Simulate	Run a simulation for the current case.
F6	Case, Generate report	Generate a PDF report for the current case.
Shift-F4		Open the SAM log.
Shift-F5	Case, Generate code	Start the code generator.
Shift-F11		Run a simulation for all cases in the file.
Ctrl-F10	Case, Duplicate	Create a duplicate of the current case.
Ctrl-F11	File, Inputs browser	Open the Inputs Browser.
Ctrl-Shift-n	File, New script	Open a new script editing window.
Ctrl-Shift-o	File, Open script	Open an .lk script file.
Ctrl-o	File, Open	Open a .sam file.
Ctrl-s	File, Save	Save a .sam file.
Ctrl-w	File, Close	Close the current SAM file.

The following shortcuts are to special testing functions for software developers that may result in losing or changing data in your SAM file without a confirmation.

Shortcut	Function
Shift-F7	Open the SAM Development Environment (open source versions only).
Shift-F8	Restart SAM and reset internal databases.
Shift-F9	Open SAM AppData folder.
Shift-F12	Generate an unhandled exception.
Ctrl-F1	Generate a segmentation fault, which will cause SAM to close without saving.

The following shortcut may cause SAM to stop functioning properly, so you should not use it unless you know what you are doing.

Shortcut	Function
Shift-F10	Save inputs for current case as default values. This will permanently modify the original default files, so only do this if you have a reason to modify the defaults.

## 4 Window Reference

### 4.1 Edit Array

The Edit Array window allows you to enter a single column of data. You can also import data from a text file, or export it.

Depending on the data you are entering you may see one of the following options:

#### Change time step

Click change time step to enter the simulation time step in minutes: 60 for hourly time steps, 15 for 15-minute time steps, etc.

#### Hourly Values (8760)

The input requires one column of 8760 values.

**Note.** SAM [omits leap years](#) from the simulation, so it assumes there are  $24 \text{ hours/day} \times 365 \text{ days/year} = 8,760 \text{ hours/year}$ , regardless of the year. It also does not account for daylight savings, so all times are in local standard time throughout the year. See [Time and Sun Position](#) for more details.

#### Number of values

Click Number of values to set the number of rows in the table.

You can copy data from your computer's clipboard or import it from a text file.

#### Copy

Click **Copy** to copy the data in the table to your computer's clipboard. You can then paste the data into a spreadsheet or text file.

#### Paste

Click **Paste** to paste time series data from your computer's clipboard into the table. For example, for hourly data, you could copy a column of 8,760 values from a spreadsheet or text file and paste it into SAM.

#### Import

Click **Import** to import time series data from a properly formatted text file. The file should contain one column of data, with a header in Row 1. SAM ignores the data in Row 1. To see an example of the file format, click **Export** and open the resulting file in a text editor.

## Export

Click **Export** to export data from the table to a text file. Be sure to include a file extension (.txt, .csv, etc.) when you save the file.

## 4.2 Edit Lifetime Data

Some input variables in SAM are arrays of time series data with values that apply over the analysis period. The length of the array is the product of the array's time scale and the analysis period, where the analysis period is the number of years in the simulation as defined on the [Financial Parameters](#) page. The Edit Lifetime Data window allows you to create a table of values for this type of input variable. The table may have a single column for one variable or multiple columns for two or more variables.

The number of rows in the table depends on the length of the array. For example, an array with a daily time scale and a 30-year analysis period would have:

$$365 \text{ days/year} \times 30 \text{ years} = 10,950 \text{ rows}$$

An array with an hourly time scale and a 25-year analysis period would have:

$$8,760 \text{ time steps/year} \times 25 \text{ years} = 219,000 \text{ rows}$$

Or, for a 15-minute time scale:

$$4 \text{ time steps/hour} \times 24 \text{ hours/day} \times 365 \text{ days/year} = 35,040 \text{ time steps/year} \times 25 \text{ years} = 876,000 \text{ rows}$$

**Note.** SAM [omits leap years](#) from the simulation, so it assumes there are  $24 \text{ hours/day} \times 365 \text{ days/year} = 8,760 \text{ hours/year}$ , regardless of the year. It also does not account for daylight savings, so all times are in local standard time throughout the year. See [Time and Sun Position](#) for more details.

The window appears on the following input pages

- [Revenue](#) for Merchant Plant financial model.
- [Lifetime and Degradation](#)
- [Battery Storage](#) to input battery dispatch profile.

To assign values to an array input variable, you can either type values by hand into the table, or import them from another program:

- Paste data from a spreadsheet program or from a text file. Use tab-delimited columns for more than one column of data.
- Import data from a text file (with tab-delimited columns for more than one column of data).

Before you try importing data from a text file, you may want to try exporting test data to a file so you can see the data format.

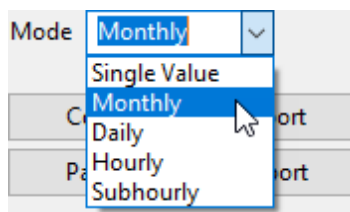
### Analysis Period

The analysis is the number of years in the system life. It is defined as an input on the [Financial Parameters](#) page. The analysis period determines the number of rows in the table for all modes except the Single Value mode.

To change the analysis period, change its value on the Financial Parameters page.

## Mode

Depending on the variable, the Edit Time Series Data window may allow you to choose a mode to define the time scale. For other variables, the mode is fixed, so you cannot change it. The following table describes the five available modes for variables that allow you to choose the length of the array.



Mode	Description	Analysis Period	Number of Rows
<b>Single Value</b>	One value applies to all time steps.	N	1
<b>Monthly</b>	One value applies to all time steps in each month over the analysis period.	N	12 × N
<b>Daily</b>	One value applies to all time steps in each day over the analysis period.	N	365 × N
<b>Hourly</b>	One value applies to each hour over the analysis period.	N	8,760 × N
<b>Subhourly</b>	One value applies to each time step over the analysis period.	N	35,040 × N*

## Copy

Copy the contents of the input table to your computer's clipboard.

## Paste

Paste data from your computer's clipboard to the input table.

## Export

Click **Export** to export data from the table to a text file. Be sure to include a file extension (.txt, .csv, etc.) when you save the file.

## Import

Click **Import** to import time series data from a properly formatted text file. The file should have one column of data, with a header in Row 1. SAM ignores the data in Row 1. To see an example of the file format, click **Export** and open the resulting file in a text editor.

## 4.3 Edit Losses

The Edit Losses window allows you to define losses that apply to the system's power output in each hour:

- Constant loss is a single loss that applies to the system's entire output.
- Hourly losses apply to specific hours of the year.

SAM reduces the system's output in each hour step by the percentage you specify for that hour. For a given hour, a loss of zero would result in no adjustment. A loss of 5% would reduce the output by 5%, and a loss of -5% would increase the output value by 5%. For subhourly simulations, SAM applies the percentage for a given hour to each time step in that hour.

### Constant loss

SAM reduces the hourly power output value for each time step by the percentage that you specify, which effectively reduces the system's total annual output by that amount.

For example, a loss of 5% for a system with a net annual output of 100,000 kWh results in a delivered electrical output of 95,000 kWh.

### Enable hourly losses

Check the box when you have a table of 8,760 loss values. Click **Edit data**, and either cut and paste a column of 8,760 values into the table, or import a text file with a header row (column label) in the first row followed by 8,760 rows of loss values. The first row of data applies to the hour beginning at 12 a.m. on January 1.

### Enable hourly losses with custom periods

Check the box when you want to apply losses to specific time periods. Choose a month, date, and time for the start time and end time, and specify a loss for that period. Click **Add period** to specify more than one time period. In the example above, the system's output is reduced by 5% between midnight April 1 and midnight April 7. The system's output is zero starting at 8 a.m. September 15 and ending at 6 p.m. September 20.

**Note.** If you use combinations of loss values, SAM combines them to calculate the total loss in each time step. For example, if you specify a constant loss of 5% and hourly losses of 25% for the first seven days in February, and the system's output at 7 a.m. on February 1 is 455 kW, the output after losses would be  $455 \text{ kW} \times (1 - 0.05) \times (1 - 0.25) = 324 \text{ kW}$ .

## 4.4 Edit Monthly Data

Some input variables, such as soiling losses, require a value for each month of the year.

	Value
Jan	6
Feb	5
Mar	5
Apr	2
May	2
Jun	2
Jul	5
Aug	5
Sep	5
Oct	5
Nov	5
Dec	6

Buttons: Copy, Paste, Enter single value: 0, Apply, OK, Cancel, Help

Type a value in the table for each month.

To assign the same value to all months, type a value for **Enter single value** and click **Apply**.

### Copy

Copy the 12 values from the table to your computer's clipboard.

### Paste

Paste values from your computer's clipboard to the table.

### Enter single value

Type a value to apply to all months.

### Apply

Apply the value in Enter single value to all months.

## 4.5 Edit Data Table by Column

For some variables, you can specify either a single value, or one or two columns of values over a range. The range might be a range of temperatures for parabolic trough absorber emittances, or a range of values over the analysis period for annual operation and maintenance costs.

The following are examples of input variables that have a schedule option:

- Operation and maintenance costs on the System Costs page
- Annual degradation rate on the [Lifetime](#) page
- Production tax credit and production-based incentive on the [Incentives](#) page
- Electricity price escalation rate on the [Electricity Rates](#) page (residential and commercial financial models only)
- Electric load escalation rate on the [Electric Load](#) page (residential and commercial financial models only)
- Occupancy and temperature schedules for the building energy load profile estimator on the [Electric Load](#) page.
- Parabolic trough absorber emittance for the physical trough model [Receivers](#) page.

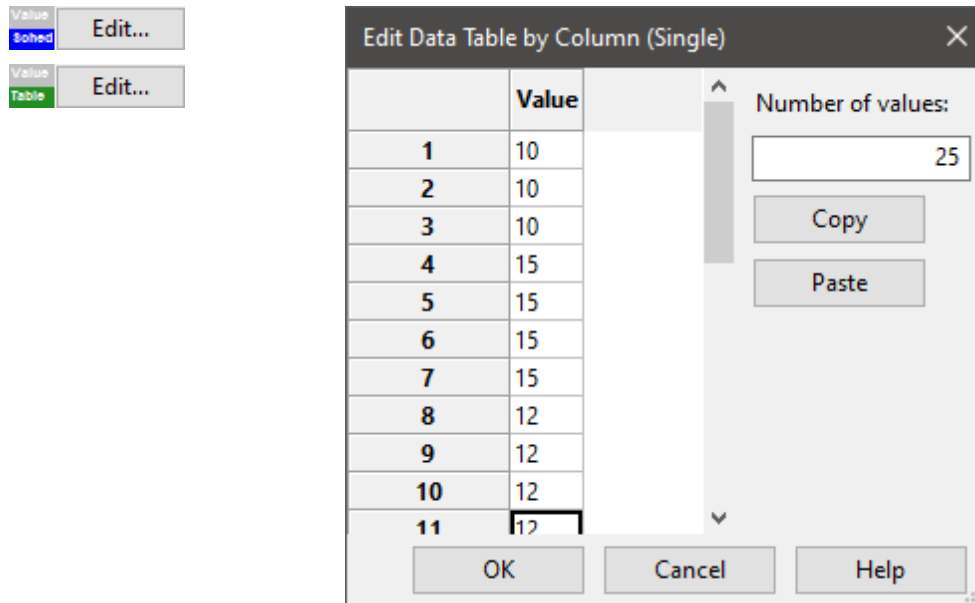
**Tip.** When you first start working with schedule, it is a good idea to try some test values and see how they affect results to be sure you understand how SAM interprets the values. For example, you can see the effect of annual schedule inputs in the [cash flow](#) table.

Variables with an option to enter a table of values have a small **Value / Sched** or **Value / Table** button next to the variable label.

- When the word "Value" is highlighted in blue, the variable is in Value mode and has a single value that you define by typing its value in the input box:

Value	0.12	Value	5
Sched		Table	

- When the word "Sched" or "Table" is highlighted in blue, the variable is in Schedule or Table mode and has multiple values that you define using a table (the values do not have to follow a pattern):

**Notes.**

In Schedule or Table mode, be sure to use values with the correct units.

When you specify currency values in Schedule mode, use the nominal or current dollar values. SAM does not apply the inflation rate to values you specify in an annual schedule.

When you specify annual rates in Schedule mode, SAM applies the rate in each year to the first value in the table. For example, on the [Lifetime](#) page, a degradation rate 0.5% for Year 5 when the Year 1 net annual output is 10,000 kWh results in an annual output value of  $(1 - 0.005) \times 10,000 \text{ kWh} = 9,950 \text{ kWh}$  in year 5. Similarly, on the [Electricity Rates](#) page, for a Year 1 buy rate of \$0.10/kWh and an escalation rate of 0.25% results in a Year 3 buy rate of  $(1 + 0.0025) \times \$0.10/\text{kWh} = \$0.10025/\text{kWh}$ .

**To enter a schedule of values for an input:**

1. Click **Sched** to change the variable's mode from a single value to schedule mode. SAM displays the Edit button.



2. Click **Edit** to open the Edit Data Table window.



	Value
1	10
2	10
3	10
4	15
5	15
6	15
7	15
8	12
9	12
10	12
11	12

Number of values:

Copy

Paste

OK Cancel Help

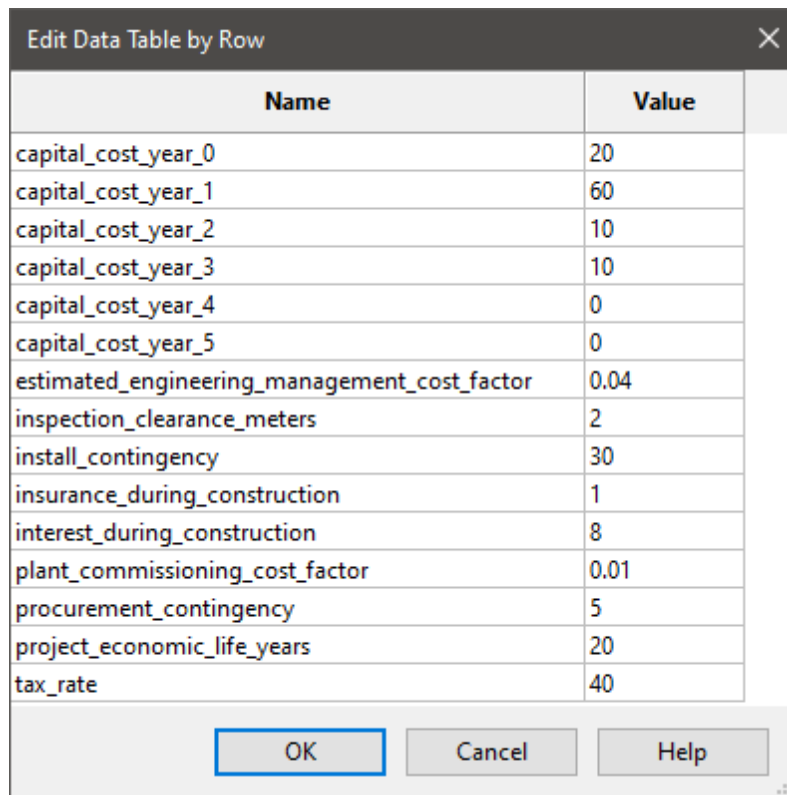
- If **Number of Values** is available, type the number of rows you need in the table. For an annual schedule, this number should be equal to or less than the number of years in the analysis period defined on the [Financial Parameters](#) page.

**Important Note.** If you are assigning annual values to a variable and you specify a number of values greater than the number of years in the analysis period, SAM ignores any values in the table for years after the end of the analysis period, which does not affect analysis results. However, if you specify a number less than the analysis period, SAM assigns a zero to each year after the number of years you specify, which may cause unexpected results.

- For each row in the table, type a valid value for the input.  
You can also copy a row of values from Excel, or a line of comma-separated values from a text file to your computer's clipboard, and click **Paste** to paste them into the table.
- Click **OK** to save the values and return to the SAM input page.

## 4.6 Edit Data Table by Row

For some inputs, such as costs for the Wind model's offshore balance of system cost model, the input is table of variables rather than a single value. For example, the General input is a cost category of several variables:



Name	Value
capital_cost_year_0	20
capital_cost_year_1	60
capital_cost_year_2	10
capital_cost_year_3	10
capital_cost_year_4	0
capital_cost_year_5	0
estimated_engineering_management_cost_factor	0.04
inspection_clearance_meters	2
install_contingency	30
insurance_during_construction	1
interest_during_construction	8
plant_commissioning_cost_factor	0.01
procurement_contingency	5
project_economic_life_years	20
tax_rate	40

To enter a value for one of the variables, type its value in the Value column.

## 4.7 Edit Parametric Values

The Edit Parametric Values window helps you define a range of values using a start value, end value, and increment for [parametric simulations](#).

### **To open the Edit Parametric Values window:**

1. Click **Parametrics** under the Simulate button.
2. Click **Quick Setup** to open the [Parametric Quick Setup window](#).
3. Click **Add** to add a variable, and then click **Edit** or double-click the variable name.

### **To define a range of values for a parametric variable:**

1. Under **Define range**, type a start value, for example 5.
2. Type an end value, for example 10.
3. Type an increment, for example 1.

4. Click **Update**.

The result under **Variable values** should be a range of values, for this example, the range would be: 1, 2, 3, 4, 5, 6, 7, 8, 9, 10.

**Regular pattern example: To assign the values 0, 2.5, 5, 7.5, 10 to a variable:**

1. Type 0 for the start value.
2. Type 10 for the end value.
3. Type 2.5 for the increment.
4. Click **Update**.

To assign values that do not follow a regular pattern, you can use the buttons under the Variable Values box to add values to the list.

**Irregular range example: To assign the values 0, 3, 4, 5, 6, 10 to a variable:**

1. Type 3 for the start value.
2. Type 6 for the end value.
3. Type 1 for the increment.
4. Click **Update**.
5. Select the number 3 in the Variable Values list.
6. Click **Add Before**.
7. Type 0 in the Add Before Selection window.
8. Click **OK**.
9. Select the number 6 in the Variable Values list.
10. Click **Add After**.
11. Type 10 in the Add After Selection window.
12. Click **OK**.

Use the Up, Down, and Remove buttons to move through the list of variable values and to delete values.

## Variable Values

The Variable Values list shows the values that SAM will assign to the parametric variable or slider.

### **Add After**

Add a value after the selected value in the Variable Values list.

### **Add Before**

Add a value before the selected value in the list.

### **Up**

Move the selected value one step up in the list.

### **Down**

Move the selected value one step down in the list.

**Remove**

Remove the selected value from the list.

**Define Range****Start Value**

The range of variable values displayed in the Variable Values list begins with this value. The start value units and magnitude should be appropriate for the variable to which values are being assigned.

**End Value**

Range of variable values ends with this value. The start value units and magnitude should be appropriate for the variable to which values are being assigned.

**Increment**

SAM adds the increment value to each value in the list to calculate the next value. Increment values may be positive, negative, or decimal values.

**Update**

Calculates values based on the parameters defined above and displays them in the Variable Values list.

## 4.8 Parametric Quick Setup

This is a reference for the Parametric Quick Setup window. See [Parametric Simulations](#) for details.

Quick Setup automates the process of adding input variables to the simulation table.

For parametric simulations with more than one variable, you can control how values are assigned to the variables in the table:

- **All combinations:** Assign all values to all variables. For example, an analysis on two variables, tilt angle with four values, and azimuth angle with five values, would result in  $4 \times 5 = 20$  simulations.
- **Independent:** Set the value of each variable to its value on the input page and assign the values you specify in Quick Setup to the remaining variables.
- **Linked:** When variables have the same number of values, run only a single simulation for each set of values. For example, an analysis on two variables, location with three values and subarray tilt angle with three values would result in three simulations.

**Note.** For an annotated example of each quick setup option, download the parametric quick setup example ([SAM 1.1 MB](#))

**Add**

Add an input variable to the parametric variables list. You must add a variable before you can assign it multiple values.

**Remove**

Remove a variable from the parametric variables list. When you remove a variable, SAM assigns the value from the variable's input page to the variable.

### Setup Linkages

Create linkages between parametric variables when the values of one of the variables is dependent on those of the other.

### Edit

Assign values to or edit values of the variable highlighted in the parametric variables list.

### Up

Move the highlighted value in the variable values list up one row.

### Down

Move the highlighted value in the variable values list down one row.

### Remove Simulation

Remove the parametric simulation setup and delete all parametric values. You can also clear the Enable this simulation checkbox to keep the setup options but exclude the parametric analysis from simulations.

### Enable this simulation

This box must be checked for the parametric simulation setup to be included in simulations when you run the model.

## 4.9 NSRDB Advanced Download

The NSRDB Download window provides access to the [NREL National Solar Radiation Database \(NSRDB\)](#) for SAM's solar power models. When you submit a query, it lists all NSRDB weather files available for the different NSRDB datasets for the given location.

### To open the Advanced NSRDB Download window:

1. On the Location and Resource page, click **Advanced download**.
2. Click **Download and add to library**.

The advanced download window provides access to the following NSRDB datasets:

- Typical meteorological year (TMY) files with 60-minute data from the PSM V3 TMY dataset. These files are constructed from historical data between 1998 and the current year, and are available for TMY-2016 to the most recent year in the database. These files are also available from standard downloads on the Solar Resource page.
- Single-year files with 30- or 60-minute data for 1998 up to the most recent year from the PSM V3 dataset. These files are also available from standard downloads on the Solar Resource page.
- Single-year files with 5-, 15-, 30-, or 60-minute data for 2018 up to the most recent year from the PSM V3 Five Minute Temporal Resolution dataset.
- Single-year files with 15-, 30-, or 60-minute data for 2017 up to the most recent year for locations outside of the Western Hemisphere from the PSM MSG IODC dataset.
- TMY data with 60-minute data constructed from historical data between 2000 and 2014 from the SUNY International TMY dataset. The SUNY International data covers India, Bangladesh, Bhutan, Nepal, Sri Lanka, and parts of Pakistan and Afghanistan.

- Single-year files with 60-minute data for 2000 - 2014 from the SUNY International Dataset.

Since NREL began producing the PSM data in 2016, it updates the PSM files every year to add data from previous years, so the date range and available TMY and TGY files changes over time. For example, as of late 2020, PSM data was available for 1998 through 2019, and included TMY-2017 and TGY-2017 files processed from the 1998 - 2017 data, and TMY-2018 and TGY-2018 files processed from the 1998 - 2018 data, etc., up to 2019.

Typical year data is available as typical meteorological year (TMY), typical global horizontal irradiance year (TGY), and typical direct normal irradiance year (TDY). For a discussion of the difference between these files, see Habte (2014) "Temporal and Spatial Comparison of Gridded TMY, TDY, and TGY Data Sets" available from the [SAM website Weather Data Publications page](#).

**Note.** Legacy NSRDB datasets are not available from the NSRDB web service. You can find links to archived data on the [SAM website Weather Data page](#).

## Downloading Data

To download one or more weather files using the Advanced NSRDB Download window:

1. The location is automatically populated from the location information on the Location and Resource page.

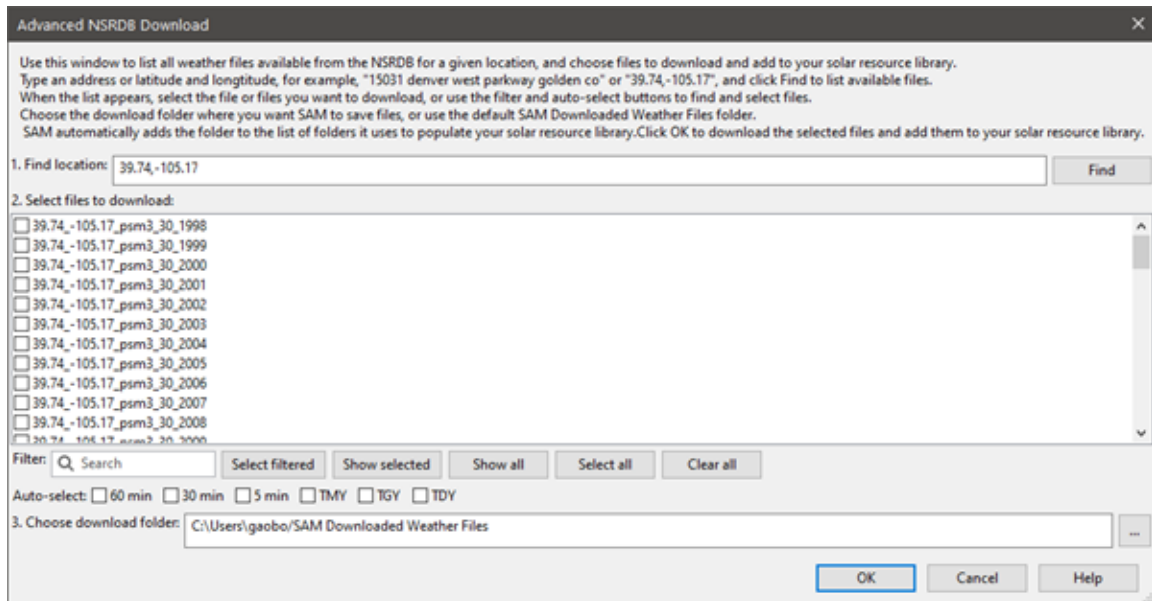
To change the location, type a new location and click **Find**. The location can be a location name, street address, or latitude-longitude pair. For example:

- Golden, Colorado
- golden, co
- 15013 Denver West Parkway, Golden CO 80401
- 80401
- thimpu, bhutan

2. In the list of available files, check the box for each file you want to download. Use the file name to identify the type of data it contains:

- *psm3*, *psm3-tmy*, *psm3-5min*, *msg-iodc*, *suny-india*, or *suny-india-tmy*, indicates the dataset.
- *5*, *15*, *30*, *60* indicates the temporal resolution.
- *tmy*, *tgy*, *tdy* indicates typical meteorological year, typical global horizontal irradiance year, or typical direct normal irradiance year, respectively.
- *1998*, *1999*, etc. indicates the year

You can use the or Filter box or check boxes to filter the list.



3. By default, SAM downloads files to your default weather file folder, which is `<user>/SAM Downloaded Weather Files`. To change the download path, type a different folder name, or click the ellipses (...) button.
4. Click **OK** to start the download.

SAM connects to the NSRDB online database and downloads all checked files to the folder you specified. When the download finishes, SAM adds the downloaded files to your solar resource library so you can find them in the list on the Location and Resource page.

## 4.10 WIND Toolkit Download

The WIND Toolkit Download window allows you to download a weather file with wind resource data for locations covered by the NREL WIND Toolkit. See [Wind Resource](#) for a description of the toolkit.

**Download Wind Resource File**

Street address or zip code

Coordinates (DD): Latitude  Longitude

Year  Measurement height (m)

- 10
- 40
- 60
- 80
- 100
- 120
- 140
- 160
- 200

Notes:

1. Use your mouse to choose one or more measurement heights.
2. Each weather file contains wind resource data for a single year.
3. NREL WIND Toolkit data is only available for locations in the continental United States.

See Help for details.

OK Cancel Help

### To download a weather file form the WIND Toolkit:

1. Choose **Street address or zip code** if you know the address or zip code of the wind project site. You can type a street address, location name, or zip code.  
Choose **Coordinates (DD)** if you know the site latitude and longitude in decimal degrees (DD).
2. Choose a year.  
WIND Toolkit data is available for 2007-2013. You can only choose one year at a time.
3. Click one or more measurement heights. SAM will include wind resource data for each height you choose.

**Note.** Choosing more than one measurement height increases the size of the weather file and may result in a longer download time. Choose measurement heights at or near the turbine hub height. For example for a 90 meter hub height, choose 80m and 120m measurement heights.



## 5 Simulation

A simulation is the set of calculations made by the performance and financial models to calculate [results](#). The performance model makes a one set of calculations for each time step in the [weather file](#) (8,760 time steps for an hourly weather file), and the financial model makes another set of calculations for each year in the analysis period that you specify on the [Financial Parameters](#) page.

You can [run simulations](#) from SAM, or from a [macro or script](#).

### Multiple Simulations

Some analysis scenarios require more than one simulation. For example, a parametric analysis requires running simulations for a range of values for one or more input variables. SAM offers three options for multiple simulations:

- A [parametric](#) simulation allows you to assign multiple values to one or more input variables and create graphs showing the dependence of a result on those variables. For example, you can use a parametric analysis to create a graph of a photovoltaic system's annual electricity output versus the array tilt and azimuth angles, or, for a parabolic trough system, you can create a graph of levelized cost of energy (LCOE) versus solar multiple to determine the optimal solar field size.
- A [stochastic](#) analysis is similar to a parametric analysis, except that SAM automatically generates values of input variables over a range and probability distribution that you specify.
- A [P50/P90](#) analysis involves running a simulation for a set ten or more single-year weather files for consecutive years, and then sorting the annual electrical output and other metrics in order of increasing occurrence over the time period. You can use that information to estimate the certainty of SAM's output predictions given your assumptions.

You can use SAM to optimize the value of one or more inputs using one of the simulation tools listed above as described in [Optimization](#).

You can also design your own models that require multiple simulations by writing a [script](#) in SAM, or you can call the SAM simulation core (SSC) outside of SAM with the [software development kit](#).

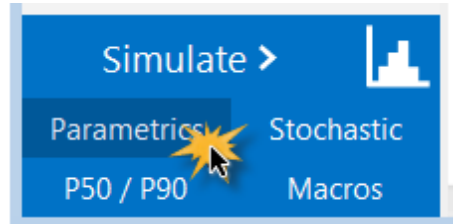
### 5.1 Parametric Simulations

A parametric simulation involves assigning more than one value to one or more input variables to explore the dependence of a result on the inputs. Parametric simulations are useful for creating graphs that show relationships between a results metric and inputs, for example to show the [relationship](#) between internal rate of return and power purchase agreement price for the single owner financial model. Parametric simulations are also useful for optimizing the value of input variables, for example, for photovoltaic systems, create a graph of annual energy (or levelized cost of energy) versus array tilt and azimuth to optimize the array orientation.

For a video demonstrating parametric simulations, see [Parametric and Statistical Analysis in SAM](#).

**Note.** Parametric simulation inputs, simulations and results are separate from the case simulation and results.

Click **Parametrics** in the lower left corner of the main window to display the Parametric Simulations page:



### **Overall steps for running parametric simulations:**

1. Set up parametric inputs by choosing parametric input variables and assigning values to them.
2. Choose output metrics.
3. Run parametric simulations.

After running the parametric simulations, SAM displays tables and graphs of the results on the Parametric Simulations page. You can use this information to choose an optimal value for an input variable, or export the data or graphs to explore relationships between input variables and results. These parametric simulation results are separate from the case results that appear on the [Results](#) page.

## **Set Up Parametric Inputs**

To set up parametric inputs, you can either use Quick Setup, or create a table by hand, or a combination of the two:

1. Quick Setup allows you to use a start value, end value, and increment to assign values to each input variable.
2. Setting up the table by hand is best when your parametric simulation involves more than one input variable and you want to limit the number of combinations of values.

### **Option 1. Quick Setup**

Use Quick Setup with a single parametric input, or when you want to model all combinations of values of multiple inputs.

#### **To use Quick Setup:**

1. On the Parametric Simulations page, click **Quick setup**.
2. Choose All combinations, Independent, or Linked.

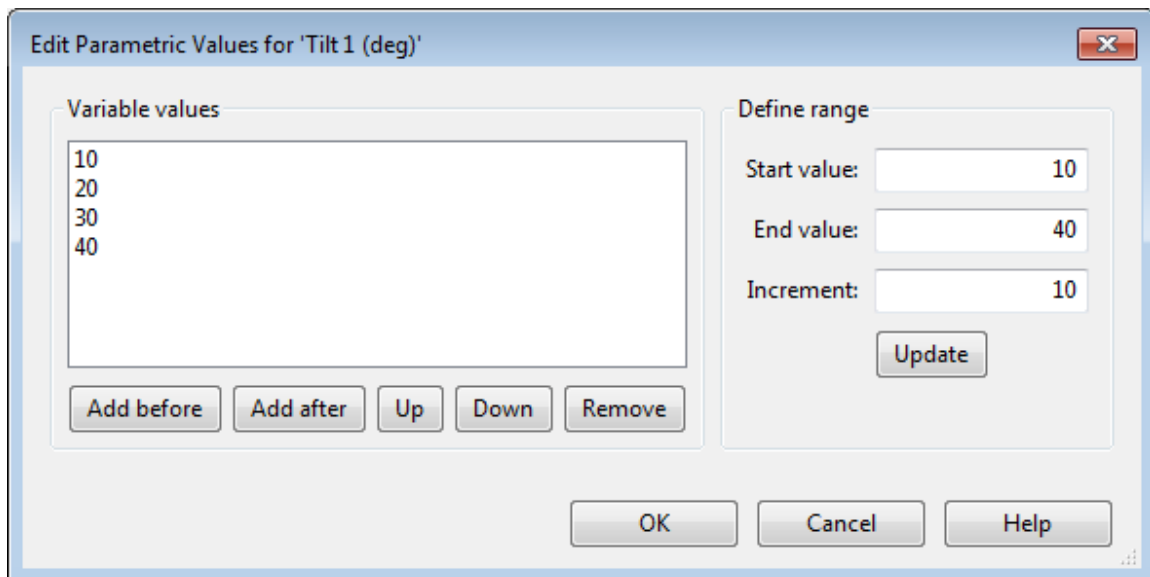
**All combinations:** Assign all values to all variables. For example, an analysis on two variables, tilt angle with four values, and azimuth angle with five values, would result in  $4 \times 5 = 20$  simulations.

**Independent:** Set the value of each variable to its value on the input page and assign the values you specify in Quick Setup to the remaining variables.

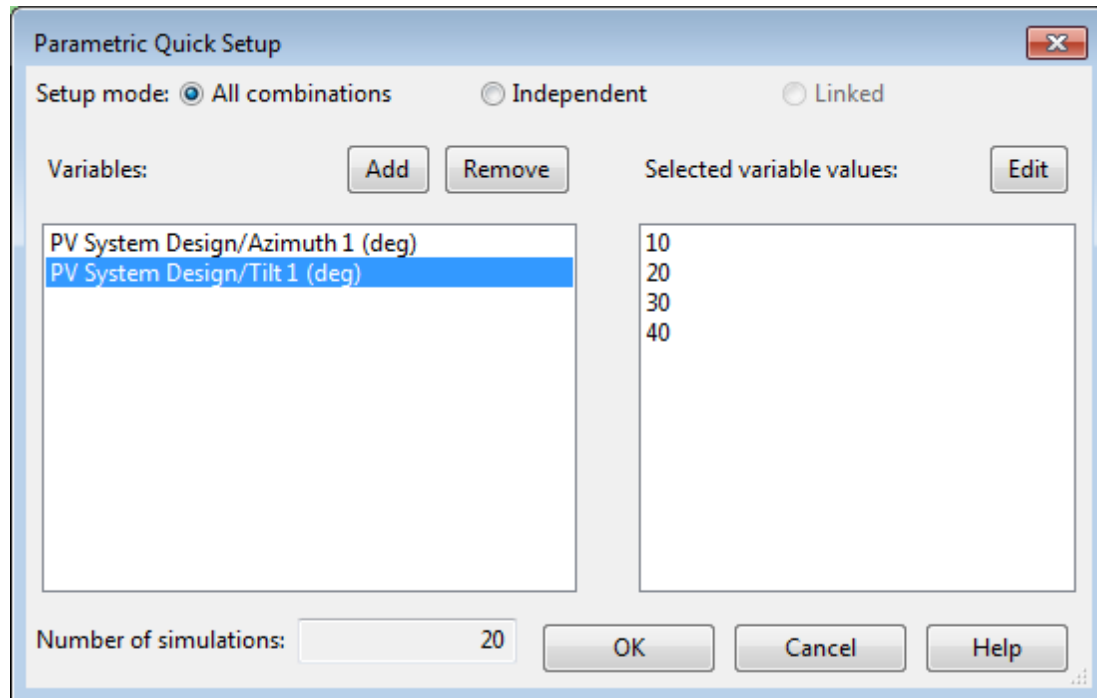
**Linked:** When variables have the same number of values, run only a single simulation for each set of values. For example, an analysis on two variables, location with three values and subarray tilt angle with three values would result in three simulations.

**Note.** For an annotated example of each Quick Setup option, see the *parametric-quick-setup-example.sam* file in the [SAM sample file collection](#).

3. In the Quick Setup window, click **Add**, and check one or more parametric input variables. Type a few letters of the variable name in the **Search** box to filter the list.
4. Click **OK**.
5. In the **Variables** list, double-click the first variable name in the list.
6. For **Start value**, type a beginning value for the range of values.
7. For **End value**, type the last value in the range.
8. For **Increment**, type the step by which you want values in the range to increase.
9. Click **OK**.



10. Repeat Steps 5 through 9 for each variable in the list.
11. Click **OK**.



- Click **Yes** to overwrite any values in the current parametric simulations table.

SAM automatically populates the table with the input variables and values along with the **Number of runs**. If you cannot see the entire table, you can use the vertical scroll bar or drag the grey divider line downward to see more of the table.

## Option 2: Set up parametric table by hand

Set up the parametric table by hand when your analysis involves more than one parametric input and you want to limit the combinations of values. For example, for a parametric study of different types of wind turbines, you might want to use a specific hub height for each wind turbine.

### To set up the parametric table by hand:

- On the Parametric Simulations page, click **Inputs**.
- Check each input variable that you want to include in the parametric simulations. Type a few letters of the variable name in the **Search** box to filter the list.
- On the Parametric Simulations page, for **Number of runs**, type the number of parametric cases you want to simulate. The table displays a row for each run. For more than about eight runs, you may need to adjust the height of the area displaying the table by dragging the grey border below the table down.
- In the table, type or choose a value for each parametric input.

## Choose Output Metrics and Run Simulations

The output metrics are the results you are using to evaluate the parametric inputs. For example, to investigate the impact of photovoltaic array tilt angle on system electricity output, you might choose Tilt as the input variable and Annual Energy as the output metric.

**To choose output metrics and run parametric simulations:**

1. Use one of the methods described above to set up parametric inputs.
2. Click **Outputs**, and choose one or more output metrics for the analysis.
3. Click **Run Simulations**.

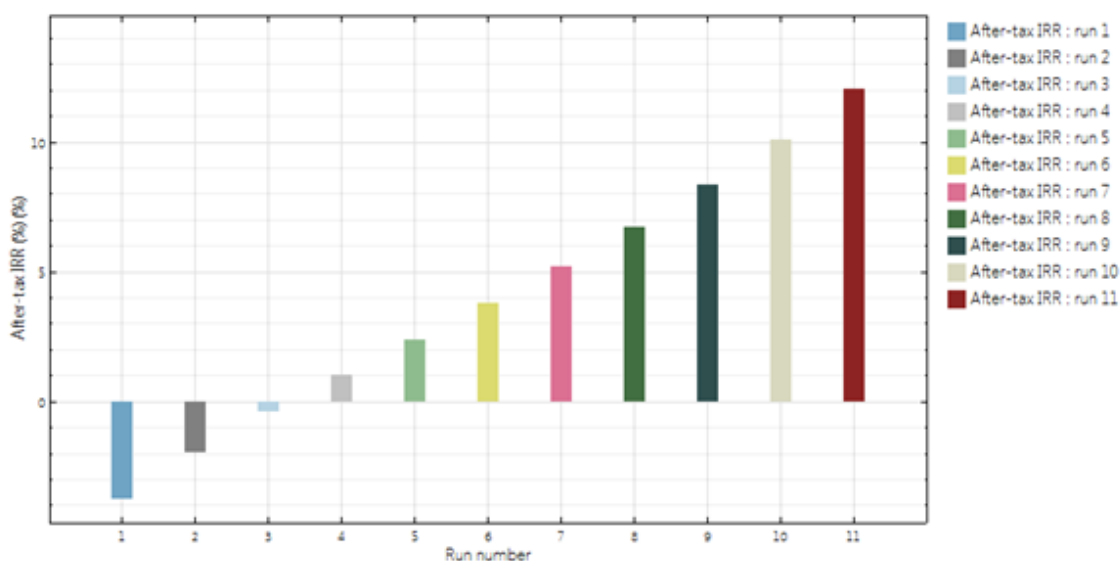
SAM displays values for each of the output metrics in the table and displays a graph for each output metric below the table.

	Hub height	Wind Turbine Selection	After-tax NPV (\$)	LCOE (nominal) (¢/kWh)
1	80	Vestas V80-2.0	1.79973e+007	2.61312
2	90	Vestas V90-2.0	3.63406e+007	1.6416
3	100	Vestas V100-1.8	4.31863e+007	1.15183
4	112	Vestas V112-3.0	6.71321e+007	1.27825

**Example: Graph the relationship between an input variables and a result**

The following graph is for an imaginary 58 MW wind farm with an installed cost of \$1,600 per kW, and shows the relationship between the project internal rate of return (result) of return and PPA price (input). The graph shows that the project requires a PPA price of at least 2.25 cents/kWh to make a positive return on investment:

	PPA price (\$/kWh)	After-tax IRR (%)
1	0.015	-3.77197
2	0.0175	-1.95377
3	0.02	-0.415855
4	0.0225	1.00339
5	0.025	2.38105
6	0.0275	3.76561
7	0.03	5.19454
8	0.0325	6.70176
9	0.035	8.32188
10	0.0375	10.0931
11	0.04	12.0599



## Import Parametric Inputs

You can import parametric input variables and their values from an Excel workbook. The workbook must be formatted as follows:

- The first worksheet in the workbook must contain a table with a column for each parametric variable. The table should look similar to the parametric input table in SAM
- Each column heading should contain a SAM variable name or label. Click **Inputs** to see a list of available variables showing each variable's name and label. The list displays all of the variables in the case using the format `label {'name'} (units) [type]`.
- The table can be anywhere in the worksheet, but all columns containing parametric data to import must be adjacent to each other. The worksheet may contain other numbers or formulas, but not other text. SAM identifies the columns by searching cells for variable names and ignores any other numbers in the sheet.

	A	B	C	D	E	F	G	H
1								
2								
3								
4				module type	tilt	azimuth		
5				0	0	180		
6				0	5	270		
7				1	0	180		
8				1	5	270		
9								
10								
11								
12								
13								

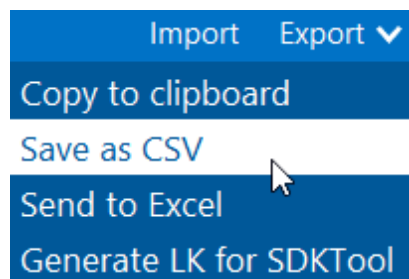
	module_type ( )	tilt (degrees)	azimuth (degrees)
1	Standard	0	180
2	Standard	5	210
3	Premium	0	180
4	Premium	5	210

- For input variables that are arrays, separate values in the array with semicolons. If the array has a single element, put a semicolon after the single value.

	A	B	C	D	E	F	G
1							
2							
3							
4							
5							
6							
7					ppa_price_input		
8					0.25;		
9					0.2;		
10					0.3;		
11					0.03;		
12							

### Export Parametric Inputs

The export tools allow you to export the table of parametric simulation results to your computer's clipboard, a CSV file, or for Windows versions of SAM, to Microsoft Excel.



If you are working with the [SAM Software Development Kit \(SDK\)](#), you can also export the parametric inputs to LK for SDKtool. Note that SAM exports each parametric case as a separate LK script, but you can modify the script yourself to add loops to perform the parametric simulations in the script.

If you are working with [LK script](#) in SAM, you can modify the LK for SDKtool to work in SAM by removing the calls to the `clear()` and `run()` functions, and by replacing the `var()` function with `set()`.

## 5.2 Stochastic Simulations

Stochastic simulations allow you to examine the effect of uncertainty in the value of one or more input variables on an output metric. For example, you could stochastic simulations to explore how the degree of uncertainty in the installation cost of one or more system components might affect the system's levelized cost of energy (LCOE) over the project life.

SAM uses the Sandia Latin Hypercube Sampling (LHS) package (<https://dakota.sandia.gov/content/packages/lhs>) to calculate statistical distributions for stochastic simulations. The LHS sampling method is described in Wyss, G; Jorgensen, K. (1998). "A user's Guide To LHS: Sandia's Latin Hypercube Sampling Software." Sandia National Laboratories. SAND98-0210. 140 pp. ([PDF 559 KB](#)) For a more general discussion of sampling-based uncertainty analysis, see Helton, J.; Davis, F.; (2000). "Sampling-Based Methods for Uncertainty and Sensitivity Analysis." SAND99-2240. 121 pp. ([PDF 5 MB](#)) For a basic description of the Latin hypercube sampling method, see the Wikipedia article "[Latin hypercube sampling](#)."

For a video demonstration of stochastic simulations, see [Parametric and Statistical Analysis in SAM](#).

For stochastic simulations, you choose one or more result variables to use as an output metric for the analysis, and one or more input variables. For each input, you choose a probability distribution from a list (uniform, normal, lognormal, etc.) and SAM generates a sample of parameter values using the Latin hypercube sampling (LHS) method. For analyses involving more than one input parameter, you can specify an optional correlation coefficient for restricted pairing of input parameters.

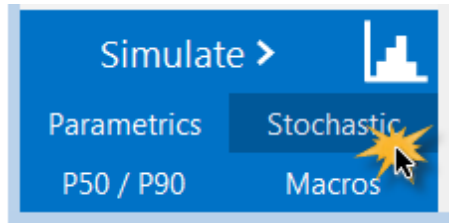
Running stochastic simulations in SAM involves the following overall steps:

1. Set up the inputs and distributions.
2. If you set up more than one input, define correlations between inputs (if any).
3. Choose output metrics.
4. Compute samples.
5. Run stochastic simulations.

**Note.** Stochastic simulation inputs, simulations and results are separate from the case simulation and results.

Click Stochastic in the lower left corner of the main window to display the Stochastic Simulations page:





## Creating a Tornado Graph using the Create a Tornado Chart Macro

SAM's Create Tornado Chart macro in an LK script that you can use to generate a tornado graph given a set of statistical distributions and input variables. See the [SAM YouTube channel](#) for a video demonstration.

### To run the Create Tornado Chart Macro:

1. Start SAM and open a project file or create a new case.
2. Click **Macros** in the lower left corner of the Main window.
3. Click **Create Tornado Chart** in the list of Macros available for the case
4. Follow the instructions to create the chart

## 5.3 P50/P90 Simulations

A P90 value is a value that is expected to be met or exceeded 90% of the time. SAM can generate P50 and P90 values for a system's annual energy output and other metrics by running hourly simulations over a multi-year period.

For a video demonstrating the P50/P90 capability, see [Parametric and Statistical Analysis in SAM](#).

SAM's P50/P90 simulations require at least 10 weather files of consecutive single-year data. The files must be in one of the [weather file formats](#) that SAM can read and use the naming convention described below.

### **Notes.**

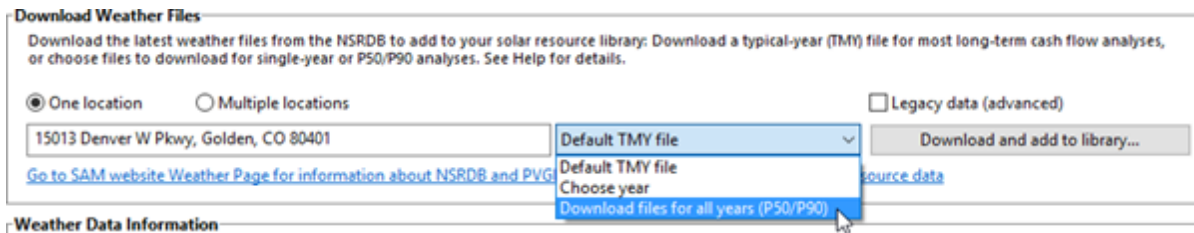
P50/P90 simulations and results are separate from the case simulation and results. It is not possible to display hourly results from P50/P90 simulations.

The **degradation rate** on the [Lifetime](#) page does not affect the Net Annual Energy values that SAM reports in the P50/P90 analysis results. However it does affect the LCOE value because SAM calculates the LCOE over the analysis period for each weather file year and applies the degradation rate to calculate the annual system output over the analysis period.

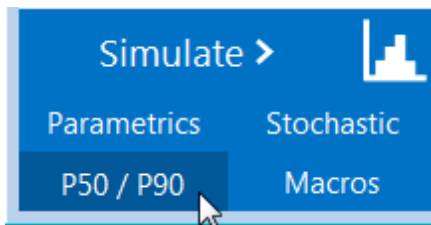
For a description of SAM's P50/P90 methodology, see Dobos, A. P.; Gilman, P.; Kasberg, M. (2012). P50/P90 Analysis for Solar Energy Systems Using the System Advisor Model: Preprint. 8 pp.; NREL Report No. CP-6A20-54488. ([PDF 372 KB](#))

**Before running P50/P90 simulations:**

- If you have your own set of weather files to use for the P50/P90 simulations, put them all in a single folder with no other files, and make sure that each file name ends with an underscore followed by the year as follows: *<file name>\_<year>.<extension>*. For example, *portland\_psm\_1998.csv*, *portland\_psm\_1999.csv*, etc.
- If you are downloading files from the National Solar Radiation Database (NSRDB), use the **Download files for all years (P50/P90)** option to download multiple single-year files for P50/P90 simulations. SAM will create a folder based on the location name in your weather file download folder, and place the files in the folder with names that follow the *<file name>\_<year>.<extension>* convention.

**To run a P50/P90 simulation:**

1. On the main window, click Configure Simulations to view the Configure Simulations page.



2. On the P50/P90 Simulations page, for **Select weather file folder**, click ... and navigate to the folder containing the series of single-year weather files.
3. Click **Run P50/P90 analysis**.

SAM displays a table of P50/90 metrics for the results variables available for the case.

## 5.4 Optimization

You can use several techniques for performing optimization in SAM:

- [Parametric simulations](#)
- [Stochastic simulations](#)
- [Scripting](#)

## 6 Weather Data

SAM's performance models (except the [generic system](#) model) use data from a weather file to represent the renewable resource and ambient weather conditions that affect the system's performance.

For details about weather data in SAM see:

- [Folders and Libraries](#)
- [Weather Data Elements](#)
- [Typical Year and Single Year Data](#)
- [Time and Sun Position](#)
- [Weather Data and LK](#)

For a description of SAM's weather file formats:

- [Weather File Formats](#)

For instructions to download or use your own weather files see:

- Photovoltaic systems: [Location and Resource](#)
- Concentrating solar power systems: [Location and Resource](#)
- Wind power: [Wind Resource](#)
- Biopower: [Ambient Conditions](#)
- Geothermal power: [Ambient Conditions](#)

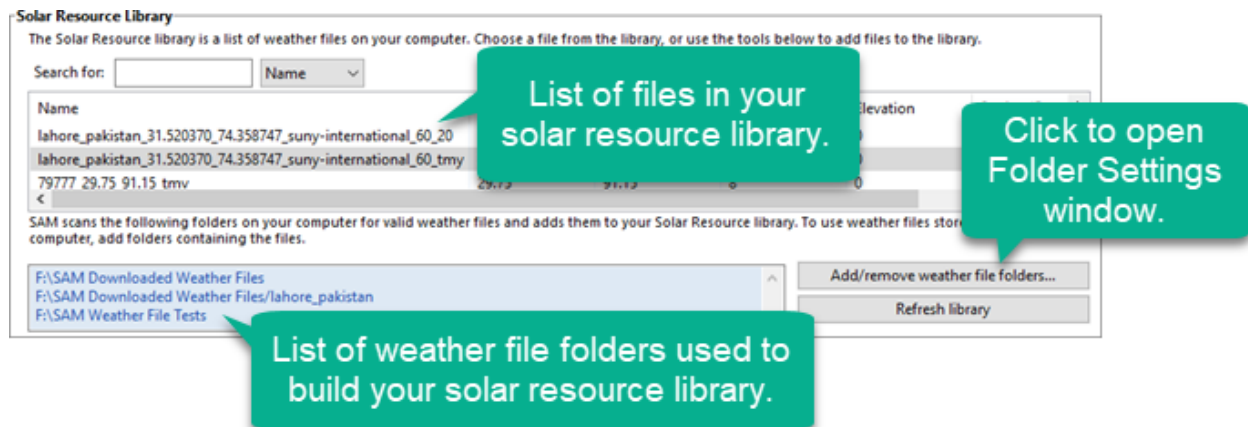
### Notes.

For more information about using weather data in SAM including links to online data sources and documents, see the [Weather Data](#) page on the SAM website.

For a good discussion of weather data for solar energy modeling, see Sengupta et al., (2017) "Best Practices Handbook for the Collection and Use of Solar Resource Data for Solar Energy Applications: Second Edition" available to download from the [Weather Data Publications](#) page on the SAM website.

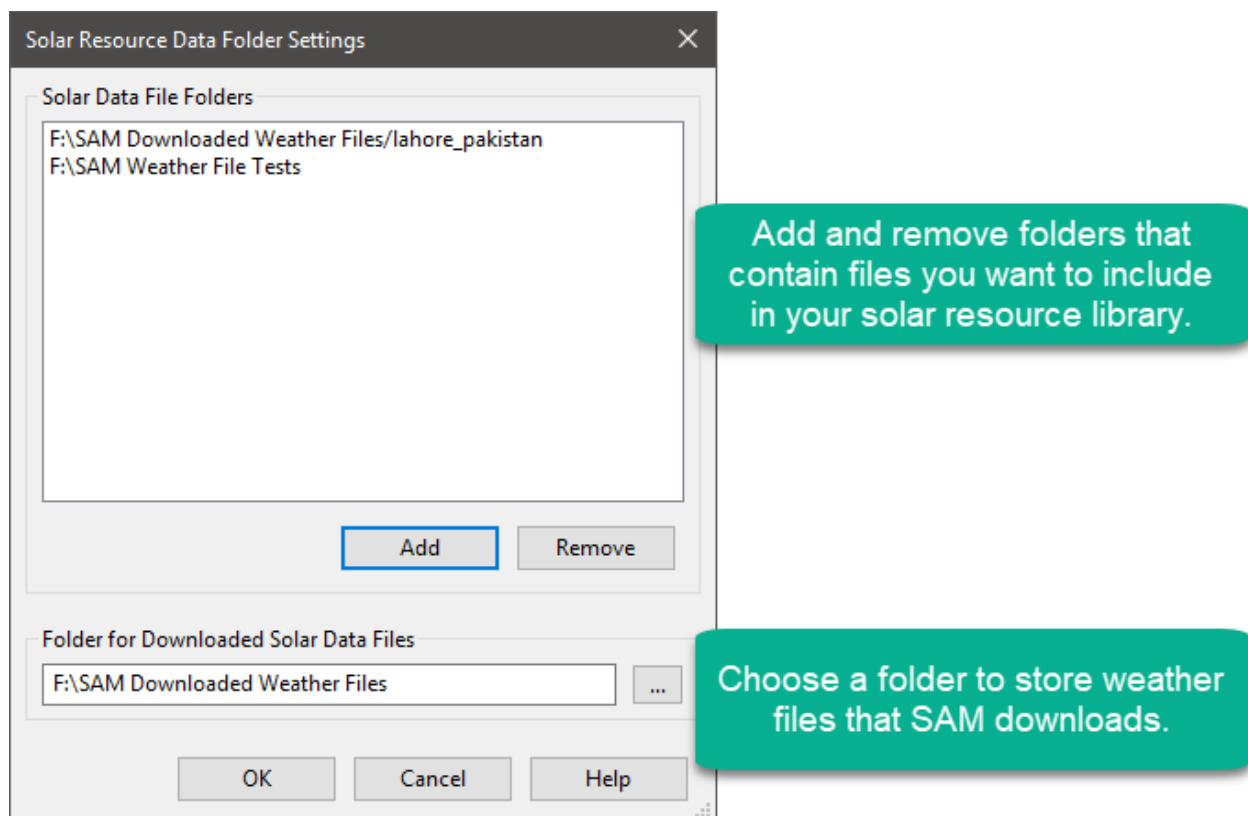
### 6.1 Folders and Libraries

The **solar resource library** and **wind resource library** are lists of weather files on your computer. As you work with SAM, you are likely to collect weather files from different sources. You might have files that you download from the National Solar Radiation Database (NSRDB), [European Commission PVGIS V5](#), purchase from a commercial vendor, or create yourself. Organize your weather files into folders on your computer, and then go to SAM's Location and Resource page and click **Add/remove weather file folders** to open the Folder Settings window where you can manage the folders that SAM scans to create the library.



The **Solar Data File Folders** are folders on your computer that contains weather files that you have added to the list of folders SAM scans to create the solar resource library.

The **Folder for Downloaded Solar Data Files** is a folder that you designate for SAM to store weather files it downloads. SAM also scans this folder and adds any weather files it finds to the solar resource library. By default, the folder is <user>/SAM Downloaded Weather Files, where <user> is your computer's user folder.



SAM comes with a default weather file folder in the SAM installation folder that stores a few weather files for the default configurations that SAM uses when you create a new project or case. You should avoid storing your own weather files in the default *solar\_resource* folder because you may lose them when you remove SAM or update to a new version of the software

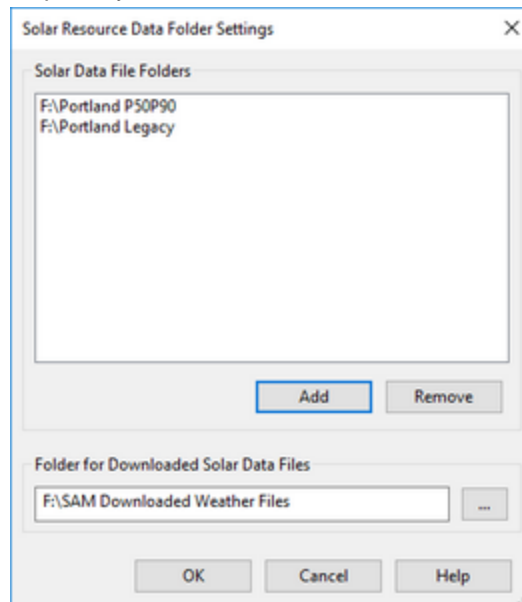
The list of weather files shown in the solar and wind resource libraries are stored in special CSV files named *SolarResourceData.csv* and *WindResourceData.csv* that are created by SAM when you first install it. These files are stored in your operating system's application data folder, which is a hidden folder used by the programs on your computer. The library files contain a list of the weather files in your weather file folders with summary information from each file that SAM displays on the Location and Resource or Wind Resource input pages. You should not modify these files. If you delete them, SAM automatically regenerates them the next time you start the software.

## Folder Settings

The Folder Settings window allows you to manage folders that SAM scans for weather files, and to specify where to store files you download from SAM.

### To add a folder to the list of folders SAM scans for weather files:

1. On the weather file input page, click **Add/remove weather file folders**.
2. In the Folder Settings window, click **Add**.
3. Navigate to the folder on your computer that contains the weather file(s).  
You can add as many folders as you wish.
4. Click **OK** to return to the input page.  
SAM displays the search paths you added at the end of the list of weather files.

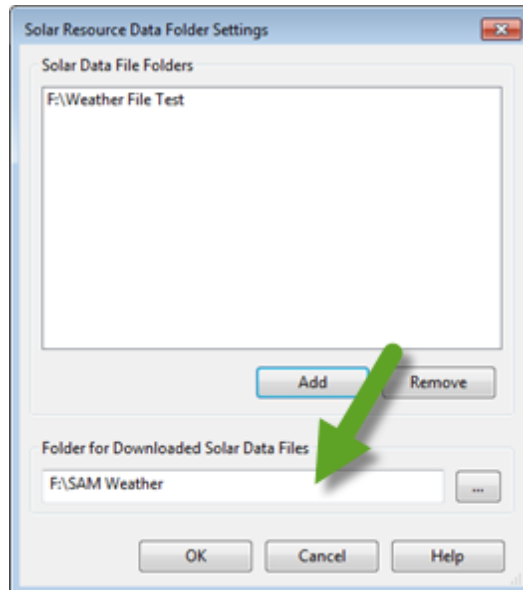


### To remove a folder from the list of folders SAM scans for weather files:

1. Click **Add/remove weather file folders**.
2. In the Folder Settings window, choose the name of the folder you want to remove.
3. Click **Remove**.  
Removing a search path does not delete any files or folders from your computer.
4. Click **OK**.

**To specify the folder for weather files you download with the Download Weather Data feature:**

1. On the weather file input page, click **Add/remove weather file folders**.
2. In the Folder Settings window, under **Folder for Downloaded Weather Files**, navigate to the folder where you want to store downloaded weather files.
3. Click **OK**.



## 6.2 Weather Data Elements

Each performance model uses different data elements from the weather file.

The following abbreviations represent the different performance models in the table below:

- PV: [Detailed photovoltaic model](#)
- PVW: [PVWatts](#)
- HCPV: [High concentration photovoltaic model](#)
- CSP: Concentrating solar power, includes:
  - Parabolic trough: [Physical](#) and [Empirical](#)
  - [Power tower](#)
  - Linear fresnel: [Molten Salt](#) and [Direct Steam](#)
  - Industrial process heat: [Parabolic Trough](#) and [Linear Direct Steam](#).
  - [Generic Solar System](#)
- SWH: [Solar Water Heating](#)
- GP: [Geothermal Power](#)
- BP: [Biomass Power](#)
- WP: [Wind Power](#)

**Note.** The [generic system](#) model does not use weather data.

Weather Data Element	PV	PVW	HCPV	CSP	SWH	GP	BP	WP <sup>5</sup>
Latitude (decimal degrees)	•	•	•	•	•			
Longitude (decimal degrees)	•	•	•	•	•			
Elevation above sea level (m)	•		•	•	•			•
Hour of the day	•	•	•	•	•		•	
Diffuse horizontal irradiance (W/m <sup>2</sup> )	• <sup>2</sup>	•	•					
Direct normal irradiance (W/m <sup>2</sup> )	•	•	•	•	•			
Global horizontal irradiance (W/m <sup>2</sup> )	• <sup>2</sup>				•			
Albedo	• <sup>3</sup>	• <sup>3</sup>						
Atmospheric pressure (mbar)(1)				•		•	•	•
Dry bulb temperature (°C)	•	•	•	•	•	•	•	•
Dew point temperature (°C)				• <sup>6</sup>				
Wet bulb temperature (°C)				• <sup>7</sup>		•	•	
Relative humidity (%)				•		•	•	
Wind velocity (m/s)	•	•	•	•			•	•
Wind direction (degrees)								•
Snow depth (cm)	• <sup>4</sup>	• <sup>4</sup>						

<sup>1</sup>Weather files in EPW format store pressure data in pascal (Pa). SAM converts those values into millibar (mbar).

<sup>2</sup>For the [detailed photovoltaic model](#), the **Radiation Components** settings on the [Location and Resource](#) page determine what combination of diffuse horizontal, direct normal, and global horizontal irradiance data that SAM uses. The weather file may contain any two of those irradiance components. The weather file may also contain a single plane-of-array irradiance value in place of the irradiance component data. By default, SAM uses the beam and diffuse components and ignores the global horizontal irradiance from the weather file.

<sup>3</sup>The [detailed photovoltaic model](#) and [PVWatts model](#) use the albedo values from the weather file if the file contains albedo data, otherwise they use a default albedo value of 0.2 if the weather file does not contain the data. The [detailed photovoltaic model](#) provides an additional option on the [Location and Resource](#) page where you can choose whether to use the albedo value from the weather file or monthly values you specify on the input page.

<sup>4</sup>The [detailed photovoltaic model](#) and [PVWatts model](#) can model snow losses due to snow covering the photovoltaic array when the weather file contains snow depth data.

<sup>5</sup>The [wind power](#) model requires wind speed, velocity, and temperature data at three different heights above the ground. See [Weather File Formats](#) for details.

<sup>6</sup>When dew-point temperature data is missing from the file, SAM calculates the value from the dry-bulb temperature and relative humidity values when they are present in the file. SAM uses the *Magnus* formula approximation described in the Wikipedia [article](#) on Dew Point with parameters from the 1947 *Psychrometry and Psychrometric Charts* and the simple approximation.

<sup>7</sup>When wet-bulb temperature data is missing from the file, SAM calculates the value from the dry-bulb temperature, atmospheric pressure, and relative humidity values when they are all present in the file. SAM uses the method described by A. T. Martinez in the 1994 [article](#) published in the Journal *Atmósfera*.

## 6.3 Typical and Single Year

SAM can simulate systems using either typical year data representing the resource and weather at a given location over a multi-year period, or single-year data.

Because SAM's financial models use multi-year cash flow calculations, SAM is designed to work with typical year weather data that describe weather conditions over a long time period. This makes it possible to use a single year of data to represent a system's annual electricity output over many years. When you run a simulation, the performance model uses hourly data from the weather file to calculate the quantity of electricity generated by the system in one year by summing the 8,760 hourly generation values. The financial model assumes that this value is the amount of electricity the system generates in each year of the analysis period you specify in the financial parameters. If you specify a non-zero **degradation rate** on the [Lifetime](#) page, then the financial model assumes that the system's electricity output decreases from year to year throughout the analysis period.

For some analyses, it may be appropriate to use single year data instead of typical year data. For example:

- To model a system's performance (ignoring the [financial model](#) inputs and results).
- To explore [savings and revenue](#) when electricity prices are weather dependent, for example, in a location with hot summers and electricity prices that increase with demand to meet summer cooling loads.
- For statistical studies involving single year data for many years, such as for [P50/P90 analysis](#).

### Typical Year Data

A typical year file uses a single year of hourly data to represent the renewable resource and weather conditions over a multi-year period. The typical year methodology involves analyzing a multi-year data set and choosing a set of 12 months from the multi-year period that best represent typical conditions over the long term period. For example, a typical year file developed from a set of data for the years 1998-2005, might use data from 2000 for January, 2003 for February, 1999 for March, etc. Annual simulation results from typical year weather data are suitable for long-term economic analysis.

In the [NREL National Solar Radiation Database \(NSRDB\)](#), TMY is [typical meteorological year data](#) developed using NREL's TMY weighting methodology described in the PSM documentation, available on the NSRDB website. The typical months in these files are based on both the global horizontal and direct radiation in the long term data, and to a lesser degree on the temperature and wind speed data. These files



may be most suitable for modeling solar power systems and for modeling non-solar technologies that use the weather data in the file (biopower, geothermal) to estimate thermal losses from the steam power cycle. They are not ideally suited for modeling winnsrd power systems.

The following are examples of weather data files that contain typical year data:

- TMY files from the NSRDB's PSM data. TMY files covering different ranges of years are available. For example TMY-2016 covers 1998-2016, and TMY-2017 covers 1998-2017.
- The representative wind data files (SRW) included in SAM's default wind resource library.
- TMY files from the [European Commission PVGIS website](#).
- EPW files from the [EnergyPlus website](#).

The NSRDB PSM dataset also includes typical global horizontal irradiance (TGY) and typical direct normal irradiance (TDY) files for 2016 up to the current year. To learn more about these typical year file types, see Habte, A.; Lopez, A.; Sengupta, M.; Wilcox, S. (2014). Temporal and Spatial Comparison of Gridded TMY, TDY, and TGY Data Sets. 30 pp. NREL/TP-5D00-60886. ([PDF 17 MB](#)).

## Single Year Data

Single year data represents the weather at a location for a specific year. Single year data is appropriate for analysis of a system's performance in a particular year, and may be appropriate for analyses involving time-dependent [electricity pricing](#) or [electric loads](#) for a given year.

The following are examples of weather files that contain single-year data:

- Single-year files from the NSRDB's PSM data.
- Wind data files (SRW) from the NREL Wind Integration Dataset.

## 6.4 Time and Sun Position

SAM assumes that the weather file contains data for a single year. The weather file may contain hourly or subhourly data.

The first row of data in the weather file is for the time step beginning at 12 a.m. (midnight) on January 1, local standard time. For hourly data, the first row is for the hour ending at 1 a.m. on January 1. For 15-minute data, the first row is for the quarter hour ending at 1:15 a.m. on January 1. For financial model time-dependent calculations, January 1 is a Monday, weekdays are Monday through Friday, and weekends are Saturday and Sunday.

SAM does not account for leap years or for daylight savings time.

### Wind Resource Data

For wind resource data ([SRW](#)), the last two columns of the first header row indicate the time step in hours (1=hourly, 0.25=15-minute, etc.), and number of time steps (8,760 for hourly, 35,040 for 15-minute, etc.). The values in the header must match the number of rows.

### Solar Resource Data

For solar resource data ([SAM CSV](#)), the weather file's time step depends on the number of weather data rows (not including the header rows) in the weather file. A file for hourly simulations should contain 8,760

data rows. A weather file for 15-minute simulations should have 8,760 hours per year × 4 time steps per hour = 35,040 data rows.

Air mass calculations use the site elevation value from the weather file header and the solar zenith angle calculated for each time step.

SAM's photovoltaic model determines the time for sun position calculations as follows:

- For hourly data with no Minute column, the sun position is for the midpoint of the hour. For the sunrise time step, the sun position is at the midpoint between sunrise time and the end of the time step. Similarly, for the sunset hour, the sun position is the midpoint between the beginning of the time step and sunset time.
- For hourly data with a Minute column and subhourly data (which must have a Minute column), use the minute value as the time for the sun position calculation for all hours, including the sunrise and sunset hours.

SAM's CSP models assume that each DNI value in the weather file represents the average irradiance over the time step, and calculate sun angles for the midpoint of the time step.

#### Notes.

In weather files from the [NREL National Solar Radiation Database](#), the irradiance data is measured instantaneously with the following time conventions:

- TMY data is measured at the beginning of the hour
- Single-year data is measured at the midpoint of the hour
- 30-minute data is measured at the beginning of each 30-minute time step (beginning and midpoint of the hour)
- Data from the older datasets (MTS3, MTS2, MTS1) assume irradiance data is the total radiation received over the entire hour.

SAM's detailed photovoltaic, PVWatts, solar water heating, and physical trough performance models have been tested with sub-hourly weather data. The other models may not work with sub-hourly weather data.

## 6.5 Weather Data and LK

Use the following variables and functions to work with weather files from an [LK script](#).

To specify a file that is in your solar resource library, set `solar_resource` to the file name as it appears in the library with no extension:

```
set( "solar_resource" , "phoenix_az_33.450495_-111.983688_psmv3_60_tmy");
```

To generate a list of files in your solar resource library as an array, and specify the third file in the library:

```
weather_file_list = library( "SolarResourceData" );  
set( "solar_resource" , weather_file_list[3] );
```

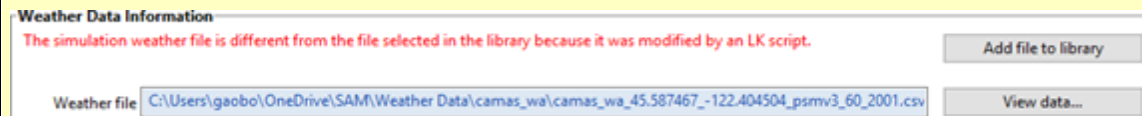
To add a folder to your solar resource library:

```
folder_list = get_settings( "solar_data_paths" );
new_folder = choose_dir( cwd(), "Choose Weather File" );
new_folder_list = folder_list + ";" + new_folder;
set_settings( "solar_data_paths" , new_folder_list );
rescanlibrary( "solar" );
```

For a weather file that is not in your solar resource library, you can also use the `user_specified_weather_file` variable:

```
set( "use_specific_weather_file" , 1 );
weather_file = choose_file( cwd(), "Choose Weather File", "SAM CSV (*.csv)|*.*" );
set( "user_specified_weather_file" , weather_file );
```

**Note.** The `user_specified_weather_file` and `use_specific_weather_file` variables are not available on the Location and Resource input page. If you use these variables in a script to set the weather file and then go to the Location and Resource page, you should see the file listed as the current weather file for simulations along with a message with a button that you can use to add the weather file's folder to your solar resource library if you want to be able to access the file directly from the Solar Resource input page later.



## 7 Weather File Formats

A SAM weather file is a text file that contains data describing the solar, wind, or marine energy resource at a particular location for a period of one year. SAM uses the following weather file formats:

- [SAM CSV format for solar resource data](#)
- [SRW format for wind resource data](#)
- [CSV format for marine energy resource data](#)

For a description of how the different performance models use weather data, see [Weather Data Elements](#).

You can use a spreadsheet program, text editor, or other software to create your own SAM weather file using data from a resource measurement program, meteorological stations, or other sources.

### Other Weather File Formats

SAM can read solar resource data from files in the TMY3 and TMY2 legacy formats from the NREL National Solar Radiation Database (NSRDB). These older formats are from datasets that have been replaced by the

latest NSRDB PSM datasets. SAM can also read weather files in the EPW format developed for the Energy Plus software.

**Note.** You can use SAM's Weather File Converter [macro](#) to convert from these and other weather file formats including PVsyst CSV, PVGIS 5 CSV, and SolarAnywhere to the SAM CSV format.

- The [TMY3 file format](#) is a comma-delimited text format with the extension .csv developed for the NSRDB 1991-2005 dataset. The first row of a TMY3 file stores data describing the location's name, and the geographic coordinates, time zone, and elevation above sea level data required for sun angle calculations. The second row stores the column headings showing units for each data element. Rows 3-8762 store weather data elements used by SAM's performance models. Many of the data elements are not used by the SAM performance models. Note. Opening and saving a TMY3 file in Excel can cause formatting changes that renders the file unreadable by SAM's weather file reader. Use SAM's [time series data](#) viewer to explore the data without modifying it, or to export it to CSV or Excel files. For a complete description of the TMY3 file format, see the TMY3 user's manual ([PDF 1.7 MB](#)).
- The [TMY2 file format](#) is a text format with the extension .tm2 developed for the NSRDB 1961-1990 dataset. The TMY2 format is not delimited, which makes the data in the text file difficult to read. You can use SAM's time series data viewer to examine and export the data in a TMY2 file. For a description of the format see the [TMY2 user's manual](#).
- The EPW file format was developed for the U.S. Department of Energy's EnergyPlus building simulation model. EPW files store comma-delimited data, and use the extension .epw. The first eight rows of a file in EPW format stores header data. SAM's performance models use only the latitude, longitude, elevation, and time zone data from the header to calculate solar angles. The remaining 8,760 rows store weather data used by the SAM performance models and other data describing the quality of the data that SAM ignores. For more details about the EPW format see the [Weather Data Format Definition](#) page.

## 7.1 SAM CSV Format for Solar

The SAM CSV format is a comma-separated text format for SAM's solar performance models. It uses a standard CSV format that you can edit in any spreadsheet program, text editor, or other appropriate software.

```

phoenix_az_33.450495_-111.983688_psmv3_60_tmy.csv
1 Source,Location ID,City,State,Country,Latitude,Longitude,Time Zone,Elevation,Local Time Zo
2 NSRDB,78208,-,-,33.45,-111.98,-7,358,-7,c,w/m2,w/m2,w/m2,c,mbar,Degrees,m/s,N/A,v3.0.0
3 Year,Month,Day,Hour,Minute,DNI,DHI,GHI,Dew Point,Temperature,Pressure,Wind Direction,Wind
4 2012,1,1,0,30,0,0,0,-2,7,970,180.1,1.5,0.174
5 2012,1,1,1,30,0,0,0,-2,6,970,183.4,1.5,0.174
6 2012,1,1,2,30,0,0,0,-3,6,970,188.4,1.5,0.174
7 2012,1,1,3,30,0,0,0,-3,6,970,195.9,1.5,0.174
8 2012,1,1,4,30,0,0,0,-4,6,970,203.1,1.6,0.174
9 2012,1,1,5,30,0,0,0,-4,6,970,207.9,1.6,0.174
10 2012,1,1,6,30,0,0,0,-4,6,970,207.4,1.5,0.174
11 2012,1,1,7,30,0,0,0,-5,7,970,199.9,1.4,0.174
12 2012,1,1,8,30,638,39,144,-5,11,970,191.9,1.9,0.174
13 2012,1,1,9,30,833,56,327,-4,15,970,178.2,2.4,0.174
14 2012,1,1,10,30,918,66,477,-3,20,970,176.2,2.5,0.174
15 2012,1,1,11,30,925,81,568,-4,23,970,181.4,2.9,0.174
16 2012,1,1,12,30,935,84,601,-4,25,970,177.2,3,0.174
17 2012,1,1,13,30,923,82,570,-5,26,970,173.2,3,0.174
18 2012,1,1,14,30,898,72,478,-4,25,970,172.4,2.5,0.174
19 2012,1,1,15,30,813,61,330,0,23,970,167.4,1.5,0.174
20 2012,1,1,16,30,616,42,149,5,19,970,152.1,1.2,0.174
21 2012,1,1,17,30,0,0,0,1,16,970,136.1,1.4,0.174
22 2012,1,1,18,30,0,0,0,0,14,970,131.9,1.5,0.174
23 2012,1,1,19,30,0,0,0,0,12,970,136.3,1.6,0.174
24 2012,1,1,20,30,0,0,0,0,12,970,148.5,1.7,0.174

```

For examples of files in the SAM CSV format, see files in the *solar\_resource* folder of your [SAM installation folder](#).

The SAM CSV format supports hourly and subhourly data with up to a one-minute resolution. SAM recognizes the weather file's time resolution based on the number of data rows in the weather file. For example, SAM recognizes a file with 8,670 data rows as an hourly data file, and a file with 35,040 rows as 15-minute data. A minute column is optional for hourly data, and required for sub-hourly data. By default, for hourly data SAM calculates sun position angles at the mid-point of the hour. However, if you specify the optional minute column for the hourly data, SAM calculates the sun position at the minute indicated in that column. For sub-hourly data, sun angles are calculated for the minute indicated in the Minute column. See [Time Convention and Sun Position](#) for additional details.

SAM requires a valid value for all time steps for each data element. It does not fill data gaps. It does perform some checks on the weather data before running a simulation, and displays messages about problems with the data in the simulation [notices](#). You can also run the **Solar Resource File Checker macro** to perform the checks without running a simulation.

## Header

The header rows provide location information and metadata, and identify the data columns.

### Row 1

Row 1 contains labels for the location data and metadata, and must include at least the following, which may be in any order and with any capitalization:

- *Latitude*
- *Longitude*
- *Time zone*
- *Elevation*

The optional **Units flag** indicates that your weather file includes an extra header row for measurement units. By default, the SAM CSV format does not include a row for measurement units in the header. To

include a units row in the header, add *hasunits* to Row 1, and set its value in Row 2 to *yes*. Then add a row after the data column heading row (described as Row 3 below) with units for each column. If *hasunits* is *no*, or is omitted from Row 1, SAM assumes that the header does not include a row for units. SAM ignores the information in the units row, but it can be useful to help you keep track of units.

For example, a valid Row 1 might look like this:

*Source,Location ID,City,State,Region,Country,Latitude,Longitude,Time Zone,Elevation*

See the table below for a complete list of Row 1 header fields, accepted labels, and units.

## Row 2

Row 2 contains values for the location data and metadata identified by the labels in Row 1. The required latitude, longitude, time zone, and elevation are numbers that SAM uses in sun position calculations during simulations:

- Latitude is a value between -90.0 and 90.0 decimal degrees north of the equator, e.g., 39.75 for Denver, and -33.95 for Sydney, Australia.
- Longitude is a value between -180.0 and 180.0 decimal degrees East of the prime meridian, e.g., -104.95 for Denver, and 116.28 for Beijing, China.
- Time zone is for standard time in hours ahead of GMT, e.g., -7 for Denver, and 5.5 for India.
- Elevation is in meters above sea level, e.g., 1615 for Denver.

For example, given the Row 1 example above, Row 2 for Phoenix, Arizona might look like this:

*TMY2,23183,Phoenix,AZ,USA,33.433333,-112.016667,-7,339*

The remaining header fields, such as source, location ID, city, state, and others listed in the table below are text values (strings) that provide information about the data, but that SAM does not use in calculations. These values are not required for SAM simulations, and can be omitted from the weather file.

Header Field	Units	Accepted Labels for Row 1
Latitude	degrees	<i>latitude, lat</i>
Longitude	degrees	<i>longitude, lon, long ,lng</i>
Time zone	hours offset from GMT	<i>tz, timezone, time zone</i>
Site elevation	meters above sea level	<i>el, elev, elevation, site elevation</i>
Year	n/a	<i>year</i>
Location ID	n/a	<i>id ,location, location id, station,station id, wban, wban#</i>
City	n/a	<i>city</i>
State	n/a	<i>state, province, region</i>
Country	n/a	<i>country</i>
Source	n/a	<i>source, src</i>
Description	n/a	<i>description, desc</i>
URL	n/a	<i>url</i>
Units flag	yes or no	<i>hasunits, units</i>

## Solar Resource Data

### Row 3

Labels identifying the data columns. SAM uses the labels to identify the columns, so they can be in any order. SAM requires a complete column of data for each data element. The Minute column is optional for hourly data.

For example, a valid Row 3 might look like this:

*Year,Month,Day,Hour,Minute,GHI,DNI,DHI,Tdry,Tdew,RH,Pres,Wspd,Wdir,Snow Depth*

See the table below for a complete list of valid Row 3 header values and units. See the description of the **Units flag** above if you want to include an additional row for units in your file.

### Row 4-8,760 (for hourly data, more rows for sub-hourly data)

Data identified in Row 3. For example:

*1988,1,1,0,0,0,0,5.6,-3.3,53,983,2.1,200,0*

SAM assumes that the weather data uses the following units:

**Note.** The format does not require leading zeros in one-digit numbers.

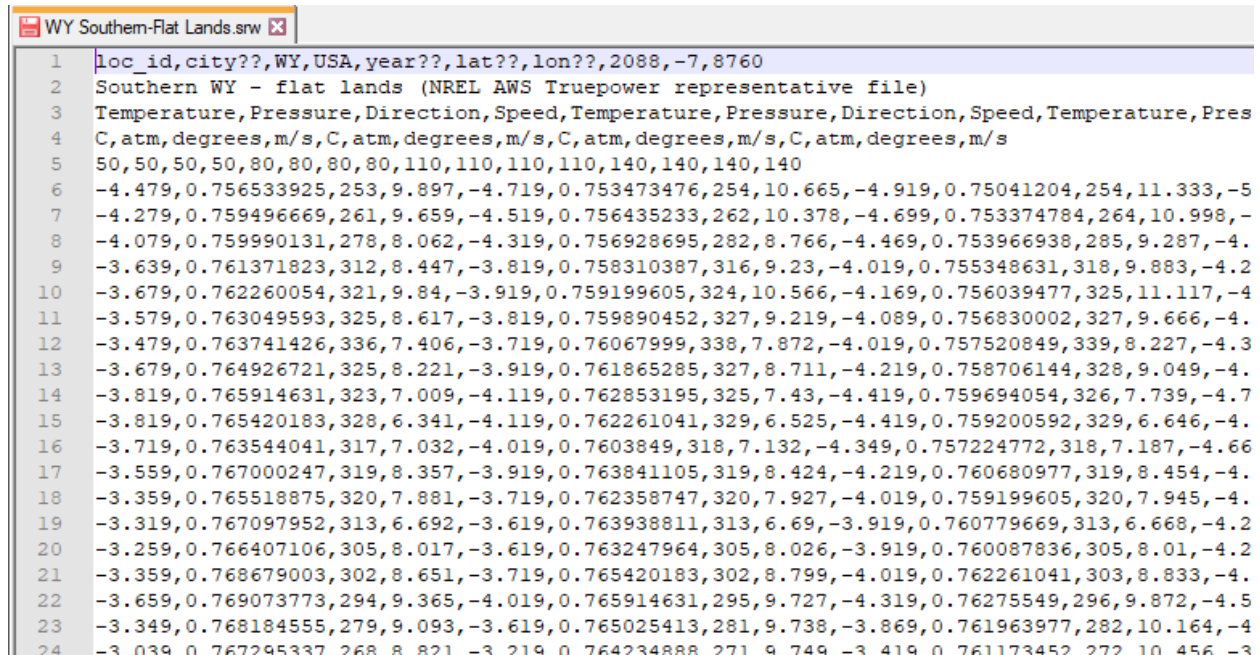
- Year is a four-digit integer (1988)
- Month is a one- or two-digit integer (Month = 1 is January)
- Day is a one- or two-digit integer indicating the day of month (Day = 1 is the first day of the month).
- Hour is a one- or two-digit integer indicating the hour of day (Hour = 0 is the first hour of the day, or the hour ending at 1 am).
- Minute is a one- or two-digit integer indicating the minute (Minute = 0 is the first minute of the hour). This value is required for sub-hourly data, and optional for hourly data. For hourly data, the minute column indicates the time you want SAM to use for sun position calculations. If you omit the value for hourly data, SAM uses the midpoint of the hour for the calculations. See [Time Convention and Sun Position](#) for details.
- Solar irradiance in  $W/m^2$ . SAM's photovoltaic models assume instantaneous irradiance. The CSP models assume average irradiance over the time step.
- Temperature in °C.
- Relative humidity in %.
- Atmospheric pressure in millibar.
- Wind speed at 10 meters above the ground in m/s.
- Wind direction at 10 meters above the ground in degrees east of North, with zero degrees indicating wind from the north.
- Snow depth in centimeters.

Data Field	Units	Accepted Labels for Row 3
Year	1950-2050	<i>year, yr</i>
Month	1-12	<i>month, mo</i>
Day	1-31	<i>day</i>
Hour	0-23	<i>hour, hr</i>
Minute	0-59	<i>min, minute</i>
Global horizontal irradiance	W/m <sup>2</sup>	<i>gh, ghi, global, global horizontal, global horizontal irradiance</i>
Beam normal irradiance	W/m <sup>2</sup>	<i>dn, dni, beam, direct normal, direct normal irradiance</i>
Diffuse horizontal irradiance	W/m <sup>2</sup>	<i>df, dhi, diffuse, diffuse horizontal, diffuse horizontal irradiance</i>
Plane-of-array irradiance	W/m <sup>2</sup>	<i>poa, pa, plane, plane of array, plane of array irradiance</i>
Ambient dry bulb temperature	°C	<i>tdry, dry bulb, dry bulb temp, temperature, ambient, ambient temp</i>
Wet bulb temperature	°C	<i>twet, wet bulb, wet bulb temperature</i>
Dew point temperature	°C	<i>Tdew, dew point, dew point temperature</i>
Wind speed	m/s	<i>wspd, wind speed</i>
Wind direction	degrees	<i>wdir, wind direction</i>
Relative humidity	%	<i>rh, rhum, relative humidity, humidity</i>
Atmospheric pressure	Millibar	<i>pres, pressure</i>
Snow depth	cm	<i>snow, snow cover, snow depth</i>
Ground reflectance (albedo)	0..1	<i>albedo, alb, surface albedo</i>
Aerosol optical depth	0..1	<i>aod, aerosol, aerosol optical depth</i>



## 7.2 SRW Format for Wind

The SRW format is a comma-delimited text format with the extension .srw for the wind power performance model.



```

1 loc_id,city??,WY,USA,year??,lat??,lon??,2088,-7,8760
2 Southern WY - flat lands (NREL AWS Truepower representative file)
3 Temperature, Pressure, Direction, Speed, Temperature, Pressure, Direction, Speed, Temperature, Pres
4 C, atm, degrees, m/s, C, atm, degrees, m/s, C, atm, degrees, m/s, C, atm, degrees, m/s
5 50, 50, 50, 50, 80, 80, 80, 80, 80, 110, 110, 110, 140, 140, 140, 140
6 -4.479, 0.756533925, 253, 9.897, -4.719, 0.753473476, 254, 10.665, -4.919, 0.75041204, 254, 11.333, -5
7 -4.279, 0.759496669, 261, 9.659, -4.519, 0.756435233, 262, 10.378, -4.699, 0.753374784, 264, 10.998, -
8 -4.079, 0.759990131, 278, 8.062, -4.319, 0.756928695, 282, 8.766, -4.469, 0.753966938, 285, 9.287, -4.
9 -3.639, 0.761371823, 312, 8.447, -3.819, 0.758310387, 316, 9.23, -4.019, 0.755348631, 318, 9.883, -4.2
10 -3.679, 0.762260054, 321, 9.84, -3.919, 0.759199605, 324, 10.566, -4.169, 0.756039477, 325, 11.117, -4
11 -3.579, 0.763049593, 325, 8.617, -3.819, 0.759890452, 327, 9.219, -4.089, 0.756830002, 327, 9.666, -4.
12 -3.479, 0.763741426, 336, 7.406, -3.719, 0.760679999, 338, 7.872, -4.019, 0.757520849, 339, 8.227, -4.3
13 -3.679, 0.764926721, 325, 8.221, -3.919, 0.761865285, 327, 8.711, -4.219, 0.758706144, 328, 9.049, -4.
14 -3.819, 0.765914631, 323, 7.009, -4.119, 0.762853195, 325, 7.43, -4.419, 0.759694054, 326, 7.739, -4.7
15 -3.819, 0.765420183, 328, 6.341, -4.119, 0.762261041, 329, 6.525, -4.419, 0.759200592, 329, 6.646, -4.
16 -3.719, 0.763544041, 317, 7.032, -4.019, 0.7603849, 318, 7.132, -4.349, 0.757224772, 318, 7.187, -4.66
17 -3.559, 0.767000247, 319, 8.357, -3.919, 0.763841105, 319, 8.424, -4.219, 0.760680977, 319, 8.454, -4.
18 -3.359, 0.765518875, 320, 7.881, -3.719, 0.762358747, 320, 7.927, -4.019, 0.759199605, 320, 7.945, -4.
19 -3.319, 0.767097952, 313, 6.692, -3.619, 0.763938811, 313, 6.69, -3.919, 0.760779669, 313, 6.668, -4.2
20 -3.259, 0.766407106, 305, 8.017, -3.619, 0.763247964, 305, 8.026, -3.919, 0.760087836, 305, 8.01, -4.2
21 -3.359, 0.768679003, 302, 8.651, -3.719, 0.765420183, 302, 8.799, -4.019, 0.762261041, 303, 8.833, -4.
22 -3.659, 0.769073773, 294, 9.365, -4.019, 0.765914631, 295, 9.727, -4.319, 0.76275549, 296, 9.872, -4.5
23 -3.349, 0.768184555, 279, 9.093, -3.619, 0.765025413, 281, 9.738, -3.869, 0.761963977, 282, 10.164, -4
24 -3.039, 0.767295337, 268, 8.821, -3.219, 0.764234888, 271, 9.749, -3.419, 0.761173452, 272, 10.456, -3

```

The format allows you to use wind resource data at one or more heights above the ground, and is designed to be flexible enough to handle a range of data.

- The file stores four data types: wind speed, wind direction, air temperature, and atmospheric pressure.
- The data can be for one measurement height or multiple heights. The measurement heights can be different for the different types of data. The file can contain air temperature, atmospheric pressure, and wind direction data at one height, and wind speed data at multiple heights.
- The file must contain a least one complete set of the four data types.
- The file stores data for a single year.
- Time steps can be hourly or subhourly. SAM determines the simulation time step from the number of resource data rows in the weather file. The number of data rows must be an integer multiple of 8760 hours/year.
- The direction measurement height must be within 10 meters of the nearest wind speed measurement height.
- For the file to work with a SAM Wind Power model simulation, the file must contain a wind speed measurement height within 35 meters of the turbine hub height.
- The file does not contain time zone information. The NREL WIND Toolkit data assumes data time steps are in UTC, where Row 1 is the hour ending at 1 a.m.

### Header Rows 1 and 2

The first two rows of the file store information about the location, and descriptive text that you can use for any purpose. SAM displays some of this information in the fields on the Wind Resource page, but does not use any of this information in simulation calculations.

**Row 1**

<location id>,<city>,<state>,<country>,<year>,<latitude>,<longitude>,<elevation>

Row 1 must have at least 8 columns. You must provide a value for each column: If you do not have a value for a column, you can use an indicator like n/a or ?? for the missing value.

SAM displays the eight location-related values on the Wind Resource page, but does not use these values in calculations.

SAM ignores the extra commas at the end of the row that your spreadsheet software may insert.

**Notes.**

SAM uses the air temperature and atmospheric pressure data for each time step to adjust the turbine power curve. It does not use the elevation above sea level for this purpose.

SAM reads the first 8 columns and ignores any additional columns. For example, it ignores the time zone in Column 9 and number of data rows in Column 10.

**Row 2**

<data source>

One line of descriptive text that SAM displays on the Wind Resource page. You may leave this line blank.

SAM ignores the extra commas at the end of the row that your spreadsheet software may insert.

**Header Rows 3 - 5**

Rows 3 and 4 tell SAM what data each column contains. SAM determines the type of data for each column based on the information in Rows 3 and 4. Rows 3 and 4 must have the same number of columns as the resource data rows.

**Row 3**

The label for each data column. Row 3 must contain at least one column for wind speed, wind direction, ambient temperature, and atmospheric pressure. For a weather file with data at more than one height above the ground, Row 3 must contain a set of columns for each height.

Acceptable labels are not case sensitive:

- *temperature* or *temp*
- *pressure* or *pres*
- *speed* or *velocity*
- *direction* or *dir*

The columns do not have to be in any particular order, and can be in a different order for each hub height.

**Row 4**

Measurement units for the resource data in each column corresponding to the resource data type in Row 3. Each column in Row 4 must contain a text value describing the measurement units. SAM displays this text in graphs and tables. For example: atm, m/s, degrees, Celsius, etc.

**Note.** SAM assumes that the resource data are in the units described below regardless of the values you specify in Row 4.

**Row 5**

Measurement height above the ground in meters for the resource data for each column defined in Row 3. Each column in Row 5 must contain an integer or decimal value.

**Resource Data Rows 6 and Higher**

The resource data rows store the wind speed, wind direction, ambient temperature, and atmospheric pressure values.

Row 6 should contain data for the hour ending at 1 am on January 1. (For time-dependent pricing calculations, SAM's financial models assume that January 1 is a Monday.)

The resource data rows store integers or decimal values with the following units:

- Wind speed in meters per second (m/s).
- Wind direction in degrees east of north (degrees), with zero degrees indicating wind from the north, and 90 degrees indicating wind from the east.
- Atmospheric pressure in atmospheres.
- Ambient temperature in degrees Celsius.

## 7.3 CSV Format for Marine Energy

SAM's marine wave energy resource file format is a comma-separated (CSV) text format.

The wave energy resource file stores data for joint probability distribution plots of the wave resource at a site as described in Dallman, A.; Neary, V. (2014) Characterization of U.S. Wave Energy Converter (WEC) Test Sites: A Catalogue of Met-Ocean Data. 125 pp.; SAND2014-18206. Sandia National Laboratories. ([PDF 8 MB](#))

```

1 Name, City, State, Country, Latitude, Longitude, Nearby Buoy Number, Average Power Flux (kW/m), Batl
2 CalWave Central Coast South, Lompoc, California, United States, 34.521 N, 120.689 W, NDBC 46218, 31
3 Hs/Te, 0.5, 1.5, 2.5, 3.5, 4.5, 5.5, 6.5, 7.5, 8.5, 9.5, 10.5, 11.5, 12.5, 13.5, 14.5, 15.5, 16.5, 17.5, 18.5, 19.5, 20.5, 21.5, 22.5, 23.5, 24.5
4 0.25, 0, 0, 0, 0, 0.11, 0.18, 0.12, 0.09, 0.11, 0.05, 0.07, 0.06, 0.07, 0.07, 0.02, 0.02, 0.01, 0, 0, 0, 0
5 0.75, 0, 0, 0, 0, 0.04, 0.16, 0.13, 0.05, 0.12, 0.1, 0.07, 0.15, 0.17, 0.08, 0.03, 0.02, 0, 0, 0, 0, 0
6 1.25, 0, 0, 0, 0, 0.15, 0.26, 0.26, 0.93, 1.26, 1.24, 1.05, 1.32, 1.51, 0.91, 0.73, 0.27, 0.2, 0.06, 0.03, 0, 0
7 1.75, 0, 0, 0, 0, 0.11, 1.16, 1.42, 2.4, 3.5, 3.63, 2.55, 2.19, 2.8, 1.93, 1.63, 0.7, 0.45, 0.21, 0.11, 0.01, 0
8 2.25, 0, 0, 0, 0, 0.38, 2.21, 2.59, 2.79, 3.33, 3.84, 3.3, 2.29, 1.34, 1.1, 0.61, 0.4, 0.18, 0.09, 0.02, 0
9 2.75, 0, 0, 0, 0, 0.43, 1.78, 1.84, 1.76, 2.84, 3.01, 2.37, 1.28, 0.76, 0.33, 0.27, 0.09, 0.05, 0.02, 0
10 3.25, 0, 0, 0, 0, 0.03, 0.37, 0.86, 0.76, 1.29, 2.55, 2.37, 1.09, 0.75, 0.28, 0.15, 0.06, 0.03, 0, 0
11 3.75, 0, 0, 0, 0, 0.05, 0.25, 0.34, 0.4, 1.1, 1.41, 0.9, 0.54, 0.17, 0.1, 0.03, 0, 0, 0
12 4.25, 0, 0, 0, 0, 0.04, 0.2, 0.13, 0.3, 0.92, 0.46, 0.45, 0.19, 0.06, 0.01, 0, 0, 0
13 4.75, 0, 0, 0, 0, 0.01, 0.05, 0.06, 0.13, 0.53, 0.33, 0.23, 0.09, 0.02, 0.01, 0, 0, 0
14 5.25, 0, 0, 0, 0, 0.02, 0.04, 0.17, 0.18, 0.11, 0.03, 0.01, 0, 0, 0, 0
15 5.75, 0, 0, 0, 0, 0.01, 0.02, 0.08, 0.14, 0.07, 0.03, 0.01, 0, 0, 0, 0
16 6.25, 0, 0, 0, 0, 0.02, 0.12, 0.05, 0.03, 0.01, 0, 0, 0, 0
17 6.75, 0, 0, 0, 0, 0.01, 0.01, 0.06, 0.04, 0.01, 0, 0, 0, 0
18 7.25, 0, 0, 0, 0, 0.01, 0.03, 0.01, 0.03, 0, 0, 0, 0
19 7.75, 0, 0, 0, 0, 0.01, 0.03, 0.01, 0.03, 0, 0, 0, 0
20 8.25, 0, 0, 0, 0, 0.01, 0.03, 0.01, 0.03, 0, 0, 0, 0
21 8.75, 0, 0, 0, 0, 0.01, 0.03, 0.01, 0.03, 0, 0, 0, 0
22 9.25, 0, 0, 0, 0, 0.01, 0.03, 0.01, 0.03, 0, 0, 0, 0
23 9.75, 0, 0, 0, 0, 0.01, 0.03, 0.01, 0.03, 0, 0, 0, 0
24

```

For examples of files in the CSV wave energy resource format, see files in the *wave\_resource* folder of your [SAM installation folder](#).

The file contains the wave resource matrix, which is a table of joint probability distributions of significant wave height and wave energy period.

#### Row 1

The first column of Row 1 contains the header *Hs/Te*, and the remaining columns contain wave energy period values in seconds in increasing order. This example is for 21 samples ranging from 0s to 21s in bins at the 0.5s mark:

*Hs/Te, 0.5, 1.5, 2.5, 3.5, 4.5, 5.5, 6.5, 7.5, 8.5, 9.5, 10.5, 11.5, 12.5, 13.5, 14.5, 15.5, 16.5, 17.5, 18.5, 19.5, 20.5*

#### Rows 2 and higher

The first column of Rows 2 and higher contains the significant wave height in meters in increasing order. The remaining columns contain the joint probability distribution (JPD) of sea states representing a frequency of occurrence as a percentage. For example, Rows 4 and higher for a range of 20 wave heights from 0.25 m to 9.75 m would be:

```

0.25, 0, 0, 0, 0, 0.11, 0.18, 0.12, 0.09, 0.11, 0.05, 0.07, 0.06, 0.07, 0.07, 0.02, 0.02, 0.01, 0, 0, 0, 0
0.75, 0, 0, 0, 0, 0.04, 0.16, 0.13, 0.05, 0.12, 0.1, 0.07, 0.15, 0.17, 0.08, 0.03, 0.02, 0, 0, 0, 0, 0
1.25, 0, 0, 0, 0, 0.15, 0.26, 0.26, 0.93, 1.26, 1.24, 1.05, 1.32, 1.51, 0.91, 0.73, 0.27, 0.2, 0.06, 0.03, 0, 0
1.75, 0, 0, 0, 0, 0.11, 1.16, 1.42, 2.4, 3.5, 3.63, 2.55, 2.19, 2.8, 1.93, 1.63, 0.7, 0.45, 0.21, 0.11, 0.01, 0
2.25, 0, 0, 0, 0, 0.38, 2.21, 2.59, 2.79, 3.33, 3.84, 3.3, 2.29, 1.34, 1.1, 0.61, 0.4, 0.18, 0.09, 0.02, 0
2.75, 0, 0, 0, 0, 0.43, 1.78, 1.84, 1.76, 2.84, 3.01, 2.37, 1.28, 0.76, 0.33, 0.27, 0.09, 0.05, 0.02, 0
3.25, 0, 0, 0, 0, 0.03, 0.37, 0.86, 0.76, 1.29, 2.55, 2.37, 1.09, 0.75, 0.28, 0.15, 0.06, 0.03, 0, 0
3.75, 0, 0, 0, 0, 0.05, 0.25, 0.34, 0.4, 1.1, 1.41, 0.9, 0.54, 0.17, 0.1, 0.03, 0, 0, 0
4.25, 0, 0, 0, 0, 0.04, 0.2, 0.13, 0.3, 0.92, 0.46, 0.45, 0.19, 0.06, 0.01, 0, 0, 0

```

```

4.75,0,0,0,0,0,0,0,0,0,0.01,0.05,0.06,0.13,0.53,0.33,0.23,0.09,0.02,0.01,0,0,0
5.25,0,0,0,0,0,0,0,0,0,0.02,0,0.04,0.17,0.18,0.11,0.03,0.01,0,0,0,0
5.75,0,0,0,0,0,0,0,0,0,0.01,0.02,0.08,0.14,0.07,0.03,0.01,0,0,0,0
6.25,0,0,0,0,0,0,0,0,0,0,0.02,0.12,0.05,0.03,0.01,0,0,0,0
6.75,0,0,0,0,0,0,0,0,0,0.01,0.01,0.06,0.04,0.01,0,0,0,0,0
7.25,0,0,0,0,0,0,0,0,0,0,0.01,0.03,0,0,0,0,0,0
7.75,0,0,0,0,0,0,0,0,0,0,0,0,0,0,0,0,0,0
8.25,0,0,0,0,0,0,0,0,0,0,0,0,0,0,0,0,0,0
8.75,0,0,0,0,0,0,0,0,0,0,0,0,0,0,0,0,0,0
9.25,0,0,0,0,0,0,0,0,0,0,0,0,0,0,0,0,0,0
9.75,0,0,0,0,0,0,0,0,0,0,0,0,0,0,0,0,0,0

```

## Special Format for Wave Energy Resource Library Files

If you want to add a file to the wave energy resource library so you can choose it from the library list on the [Wave Resource](#) page instead of checking **Choose wave energy resource file**, you must create a special library version of the file that includes two additional header rows with 13 columns each and put it in the `wave_resource` library folder of your [SAM installation folder](#). These extra rows provide location information and metadata that SAM uses to display for reference on the [Wave Resource](#) page, but does not use for the performance simulation.

### Notes.

You only need the optional header rows if you are making a special file for the wave energy resource library.

For information about where to store your wave energy resource files, see [Managing Wave Resource Files](#).

### Row 1 for special library file

Row contains labels for the 13 required metadata variables. Row 1 must contain the following text, with column names in the following order:

*Name, City, State, Country, Latitude, Longitude, Nearby Buoy Number, Average Power Flux (kW/m), Bathymetry, Sea Bed, Time Zone, Data Source, Notes*

### Row 2 for special library file

Row 2 contains values for the metadata identified by the labels in Row 1. The file must contain values for this metadata for SAM's file reader to work correctly.

To ensure SAM can read the data correctly, do not enclose values in quotation marks.

### Row 3 for special library file

Same as row 1 described above.

### Rows 4 and higher for special library file

Same as rows 2 and higher described above.

Header Label	Description
Name	Name of wave resource site
City	Name of city onshore nearest the site
State	State name or abbreviation
Country	Country name
Latitude	Latitude, for example 35.4 N, 25.6 S
Longitude	Longitude, for example 120.689 W, 64.3 E
Nearby Buoy Number	Identification number for nearest marine observation buoy
Average Power Flux (kW/m)	The average annual power flux measured at the site
Bathymetry	The submarine topography at the site
Sea Bed	The soil composition of the sea bed
Time Zone	The time zone of the site, for example -7, 2
Data Source	The source of wave resource data
Notes	Additional information about the data

## 8 Photovoltaic Systems

SAM offers three models for photovoltaic systems (see [Choose Models](#) for instructions):

### Detailed Photovoltaic

The [detailed photovoltaic model](#) calculates a grid-connected photovoltaic system's electrical output using separate module and inverter models. It requires module and inverter specifications along with information about the number of modules and inverters in the system. You can either provide your own module and inverter specifications from a manufacturer's data sheet, or choose a module and inverter from libraries. The detailed photovoltaic model estimates losses due to the effect of temperature on module performance, and has options for calculating shading and other losses in the system. The model also includes a system sizing assistant to help you determine the number of modules and inverters in the system.

Use the detailed photovoltaic model when you have detailed information about the equipment that will be used in the system.

### PVWatts Model

The [PVWatts model](#) is an implementation of NREL's popular [online photovoltaic calculator](#). It models a grid-connected photovoltaic system using a few basic inputs to describe the system's nameplate capacity, array orientation and mounting type, and system losses. PVWatts makes internal assumptions about module and

inverter characteristics for three types of modules. SAM's implementation of PVWatts includes options for modeling shading that are not available with the online version.

Use the PVWatts model for preliminary project analysis before you have information about the type of equipment you plan to use in the system, or for other analyses that require a reasonable estimate of a photovoltaic system's electrical output.

### **Concentrating Photovoltaic**

The [concentrating photovoltaic](#) model is appropriate for grid-connected photovoltaic systems with high concentration photovoltaic modules. The concentrating photovoltaic model uses separate models to represent the module and inverter. It requires information about the design of the concentrator and efficiency of the cell at different irradiance levels. For the inverter model, you can either use specifications from a manufacturer data sheet, or choose an inverter from a library.

The following table summarizes the three photovoltaic models:

	Detailed Photovoltaic	PVWatts	Concentrating Photovoltaic
Flat plate crystalline and thin film modules	•	•	
Low concentration photovoltaic (LCPV) modules	•	•	
High concentration photovoltaic (HCPV) modules			•
Array output (DC)	•	•	•
Inverter output (AC)	•	•	•
System sizing assistant	•		
DC/AC sizing ratio	•	•	
Specify system nameplate capacity	• *	•	
Specify numbers of modules and inverters	• *		•
Specify separate module and inverter parameters	•		•
Multiple subarrays with optional voltage mismatch calculator	•		
Tracking options (fixed, one- or two-axis tracking)	•	•	
Adjustable tracker rotation limit for one-axis tracking	•		
Azimuth axis tracking	•		
Shading factors for nearby objects	•	•	•
3D shade calculator	•	•	
Self-shading for one-axis trackers	• *	•	
Backtracking for one-axis trackers	• *	• *	
Self-shading for fixed arrays (no tracking)	• *		
Temperature effects on module performance	•	•	•
DC and AC loss inputs	•	•	•
System availability	•	•	
Loss diagram	•		
Estimate land cost from array area	•		•

\* Optional feature



## 8.1 Location and Resource

The Location and Resource page provides access to the solar resource library, which is a collection of weather files stored on your computer. When you first install SAM, it comes with a few default weather files in the library. As you use SAM for your own projects, you should add files to build your own library. Once files are in your library, you can use them for different projects and with different versions of SAM.

The screenshot shows the 'Solar Resource Library' window. A green callout bubble points to the table of weather files, stating 'Choose a weather file from the library.' The table lists three files with their respective coordinates and station IDs. Another callout bubble points to the list of folders below the table, stating 'List of solar resource folders.' A third callout bubble points to the 'Weather Data Information' section, stating 'Weather file for simulation.' A fourth callout bubble points to the header data fields, stating 'Information from weather file header.' A fifth callout bubble points to the annual averages section, stating 'Summary data calculated from time series data.'

**Solar Resource Library**  
The Solar Resource library is a list of weather files stored on your computer, or use the tools below to add files to the library.

Search for:  Name

Name	Latitude	Longitude	Time zone	Elevation	Station ID
daggett_ca_34.865371_-116.783023_psmv3_60_tmy	34.85	-116.78	-8	561	91486
des_moines_ia_41.586835_-93.624959_psmv3_60_tmy	41.57	-93.62	-6	263	757516
faroo nd 46.9 -96.8 mts1 60 tmy	46.9	-96.8	-6	274	14914

SAM scans the following folders on your computer for valid weather files to add to the solar resource library. To use weather files stored on your computer, add folders containing the files.

C:\Users\<user>\SAM Downloaded Weather Files  
F:\little\_rock\_ar  
F:\PVGIS 5

Add/remove weather file folders...  
Refresh library

**Weather Data Information**  
The following information describes the weather file selected from the Solar Resource library above. This is the file SAM will use when you click Simulate.

Weather file: C:\SAM\2018.10.29\solar\_resource\daggett\_ca\_34.865371\_-116.783023\_psmv3\_60\_tmy.csv

**Header Data from Weather File**

City	Station ID: 91486	Latitude: 34.85 °N
State	Data Source: NSRDB	Longitude: -116.78 °E
Country	Elevation: 561 m	Time zone: GMT -8

**Annual Averages Calculated from Weather File Data**

Global horizontal	NaN kWh/m <sup>2</sup> /day	Average temperature	17.3 °C
Direct normal (beam)	7.65 kWh/m <sup>2</sup> /day	Average wind speed	2.4 m/s
Diffuse horizontal	1.27 kWh/m <sup>2</sup> /day		

\*NaN indicates missing data.

There are two ways to add files to your solar resource library:

### 1. Download files from the NREL National Solar Radiation Database (NSRDB)

Use the download weather file options and click **Download and add to library** to get the most up-to-date data from the NSRDB for long-term cash flow analysis, single-year analysis, and P50/P90 analysis.

### 2. Add weather file folders

If you have weather files from a source other than the NSRDB or that you've downloaded yourself directly from the NSRDB website, click **Add/remove weather file folders** to add the folder containing the files to the **Solar Data File Folders** list. SAM automatically adds any weather files it finds in these folders to the solar resource library so they will appear in the list.

When you install SAM, it creates the default download folder <user>/SAM Downloaded Weather Files

folder where weather files you download from the NSRDB are stored. You can change that folder by clicking **Add/remove weather file folders** and changing the **Folder for Downloaded Solar Data Files**.

For locations not in the NSRDB, you can download weather files in the EPW format from the European Commission Photovoltaic Geographical Information System [PVGIS V5 website](#).

## See also

[Weather File Formats](#)

[Weather Data Elements](#)

[Typical and Single Year](#)

[Time and Sun Position](#)

[Folders and Libraries](#)

[Weather Data and LK](#)

### Notes.

You may want to model your system using weather data from several different sources and locations around your project site to understand how sensitive your analysis results are to the weather assumptions, and how much variation there is in the data from the different weather files.

You can compare results for a system using more than one weather file in a single case by using SAM's [parametric simulation](#) option.

For more information about weather data, including where to find data for locations outside of the United States, see [Weather Data](#) on the SAM website.

For a helpful discussion of weather data and power system simulation, see Sengupta, M.; Habte, A.; Gueymard, C.; Wilbert, S.; Renne, D.; Stoffel, T. (2017). "Best Practices Handbook for the Collection and Use of Solar Resource Data for Solar Energy Applications: Second Edition." NREL Report No. TP-5D00-68886. ([PDF 8.1 MB](#))

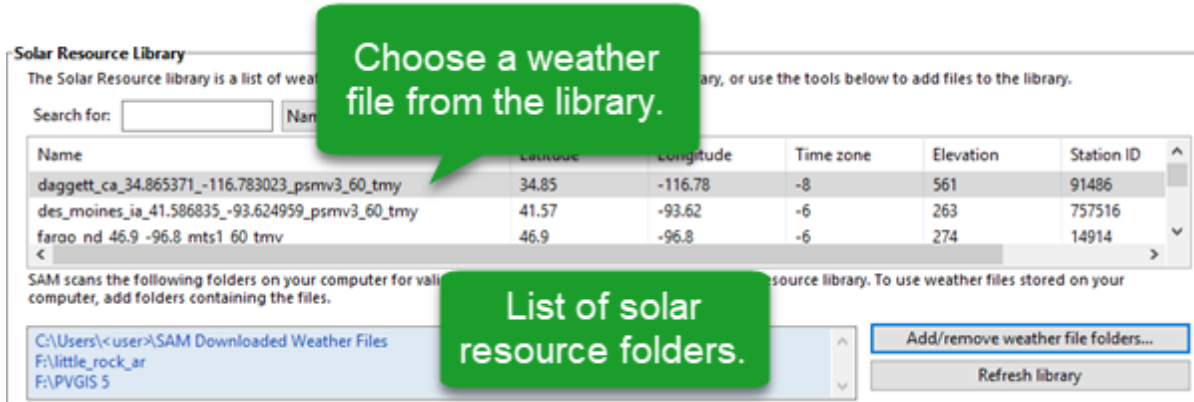
## ▼ Solar Resource Library

SAM's solar resource library displays information from weather files in your solar resource data folders. The default solar resource library that comes with SAM contains weather files for a few locations around the United States for the default configurations. As you use SAM, use **Add/remove weather file folders** to build a library of files for locations you frequently use as described in [Folders and Libraries](#).

### **To choose a file from the solar resource library:**

- Click the location name in the list. You can type a few letters of the file name in the Search box to filter the list.

The full file name and information about the selected file appears under **Weather Data Information**. To see the data in the file, click **View data**.



### Add/remove weather file folders

Use the folder settings to tell SAM what folders on your computer it should scan for weather files to build the solar resource library. SAM adds any files it can identify as valid weather files in each folder you specify to the library.

Before adding a file to the library, SAM checks the data in the file displays a message if it finds any problems with the data in the file.

SAM will only add valid weather files to the library. If you add a folder that contains CSV files that are not in the SAM CSV format, it will not add those files to the library.

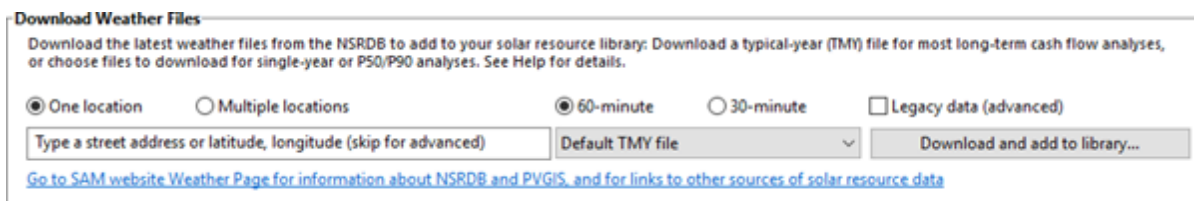
The list of solar resource folders are the folders that SAM scans for weather files to build the solar resource library.

### Refresh library

Refresh the library after adding files to the weather file folder. In most cases, SAM should automatically refresh the library as needed, but you may need to manually refresh it.

## Download Weather Files

SAM can download weather files from the latest National Solar Radiation Database (NSRDB) Physical Solar Model (PSM) datasets. For all NSRDB datasets, SAM can download single-year files or typical-year files.



**Note.** For locations not in the NSRDB, you can download EPW files from the European Commission Photovoltaic Geographical Information System [PVGIS V5 website](#) to a folder on your computer, and then use the [folder settings window](#) to add the folder to the list of folders SAM scans to build the solar resource library.

### To download a typical-year weather file for a single location:

1. Replace the text "Type a location name, street address or latitude and longitude" with a street address, city and state or country name, zip code, or latitude longitude pair. For example:

- Golden, Colorado
  - golden, co
  - 15013 Denver West Parkway, Golden CO 80401
  - 80401
  - thimpu, bhutan
2. Click **Download and add to library**.

For more instructions to download multiple files, see [Weather File Download Instructions](#) below.

SAM converts the address you type to a latitude and longitude pair for the location, and submits that information to the NSRDB along with your email address. If the location is in the region covered by the NSRDB, it returns a weather file in the SAM CSV format, and adds it to your weather file download folder. Otherwise, it displays a message telling you the location is not covered by the NSRDB.

When you first install SAM, it creates the *SAM Downloaded Weather Files* folder and assigns it as your weather file download folder. You can change the weather file download folder by clicking **Add/Remove weather file folders**. See [Folders and Libraries](#) for details.

When the download finishes, SAM displays a prompt asking you if you want to open the weather file download log. This prompt is the indication that the download finished. During the download and before that prompt appears, SAM may become unresponsive. If it does, wait for the prompt to avoid interrupting the download.

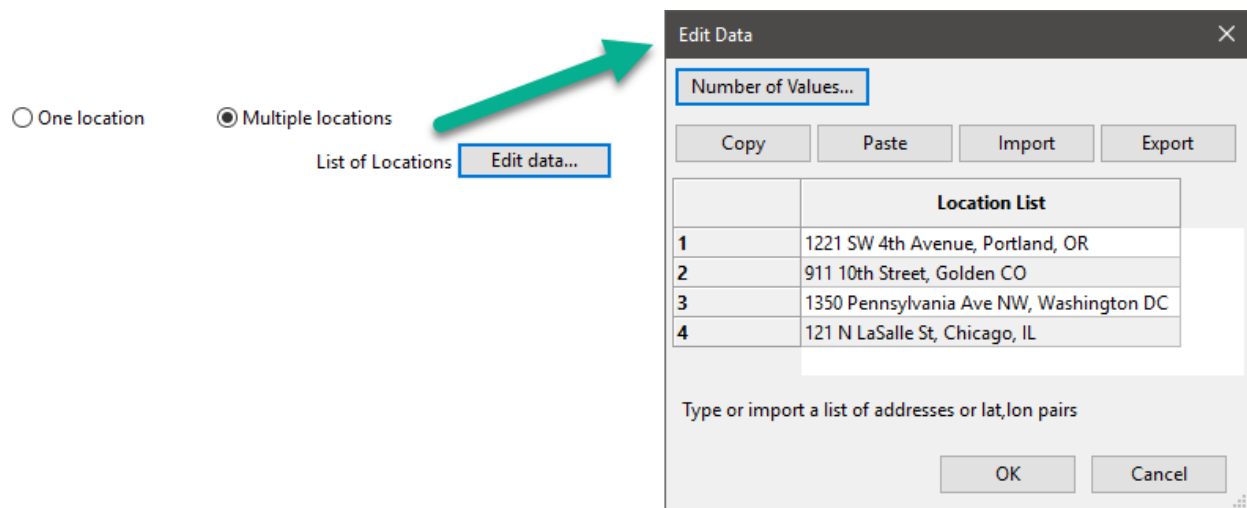
The weather file download log is a text file that SAM creates in your weather file download folder, and serves as a record of all of the files you download from the NSRDB. For each download, it lists the date and time of the request, the information you provided, the URL SAM generated, the name of the file returned by the NSRDB, or error messages it returns if the download fails. This information is useful for troubleshooting weather file download problems.

**Note.** Downloading multiple weather files from the NSRDB can take a long time. If you download files for multiple locations or years, be prepared to wait for the files to download. The download log file reports the time it takes for each file to download. Download times depend on your internet connection and computer. For a new computer with a fast connection, downloading and processing a single file takes about 10 seconds.

### One location, Multiple locations

Choose **One location** to download a weather file for a single location.

Choose **Multiple locations** to submit a list of locations and download a file or files for each location. For Multiple locations, click **Edit data** to open the Edit Data window where you can enter the list of locations and click **Number of Values** to enter the number of locations in the list.

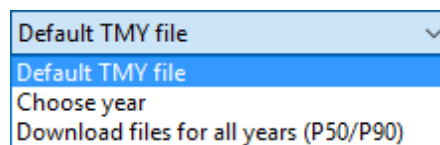


### 60-minute, 30-minute

Choose **60-minute** to download weather files with hourly time steps or 8,760 data records.

Choose **30-minute** to download files with 30-minute time steps or 17,520 data records. Thirty-minute data is not available for the NSRDB SUNY International dataset.

### Download options



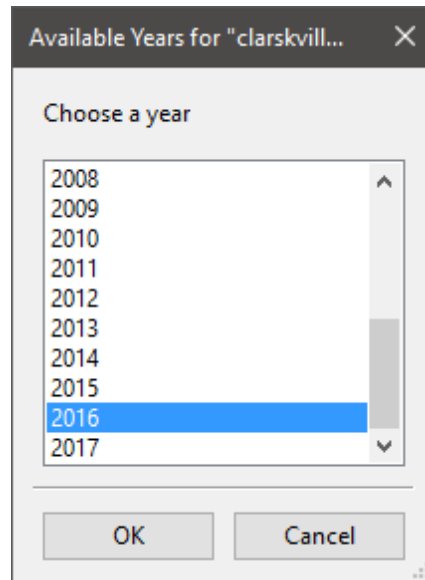
### Default TMY file

Download a typical meteorological year weather file for the location or locations you specified.

Typical year data is appropriate when you are using simulation results for a single year to make cash flow calculations over a multi-year period.

### Choose year

Choose a single year file to download. After you click the Download button, SAM prompts you with a list of available years for each location you requested to choose a year.



The single year option is appropriate when you want to see how the system would perform in a particular year. For example, for a residential or commercial system, if you have measured building load data for a given year, you could use weather data for the same year to see how the system's power output compares to the load.

If you use both **Choose year** and **Multiple locations**, SAM prompts you for a year for each location.

SAM queries the NSRDB to generate the list of available years. The list of available years varies between regions.

### Download files for all years (P50/P90)

Download a set of single-year files covering the range of historical data (nineteen files for 1998 through 2017 as of October 2018 for PSM data). When you click download, SAM creates a folder in your weather file download folder to store the single year files based on the location address or latitude-longitude pair you typed. It also downloads the typical meteorological year (TMY) file for the location and stores it in your weather file download folder.

SAM appends an underscore with the year to the file name so that the P50 P90 simulations work correctly. See [P50/P90 Simulations](#) for details.

If you choose to download files for all years with **Multiple locations**, SAM downloads a set of files for each location, and puts the files for each location in a separate folder. Note that this may take a long time.

## Weather File Download Instructions

### Examples of valid street address or latitude-longitude pairs:

- golden colorado
- golden, co
- 15013 Denver West Parkway, Golden CO 80401
- 80401
- 39.75, -105.15

- Super Market, F-6 Markaz, Islamabad, Pakistan
- New Delhi, India

**Note.** When the download finishes, SAM displays a prompt asking you if you want to open the weather file download log. This prompt is the indication that the download finished. During the download and before that prompt appears, SAM may become unresponsive. If it does, wait for the prompt to avoid interrupting the download.

**To download an hourly typical-year (TMY) weather file from the NSRDB (use this option for most situations):**

1. Click **One location**.
2. Type either a street address or latitude-longitude pair.
3. Click **60-minute**.
4. Choose **Default TMY File**.
5. Click **Download and add to library**.

**To download files for more than one location:**

1. Click **Multiple locations**.
2. Click **Edit data**.
3. In the Edit Data window, click **Number of Values** and type the number of locations to create a table with a row for each location.
4. Type a street address or latitude-longitude pair in the table for each location.
5. Click **OK**.
6. Choose a time step, **60-minute** for hourly, or **30-minute** for 30-minute data.
7. Choose the type of file(s) you want to download as described below.
8. Click **Download and add to library**.

## Weather Data Information

**Weather Data Information**  
The following information describes the weather file in the Solar Resource library above. This is the file SAM will use when you click Simulate.

Weather file:  [View data](#)

**-Header Data from Weather File-**

City	<input type="text" value="-"/>	Station ID	<input type="text" value="91486"/>	Latitude	<input type="text" value="34.85 *N"/>
State	<input type="text" value="-"/>	Data Source	<input type="text" value="NSRDB"/>	Longitude	<input type="text" value="-116.78 *E"/>
Country	<input type="text" value="-"/>	Elevation	<input type="text" value="561 m"/>	Time zone	<input type="text" value="GMT -8"/>

**-Annual Averages Calculated from Weather File Data-**

Global horizontal	<input type="text" value="NaN"/>	kWh/m <sup>2</sup> /day	Average temperature	<input type="text" value="17.3"/>	°C
Direct normal (beam)	<input type="text" value="7.65"/>	kWh/m <sup>2</sup> /day	Average wind speed	<input type="text" value="2.4"/>	m/s
Diffuse horizontal	<input type="text" value="1.27"/>	kWh/m <sup>2</sup> /day	*NaN indicates missing data.		

### Weather File

The path and name of the active weather file SAM will use for simulation. Download a different file from the NSRDB, or click a different file name in the library to change the file.

### View data

Display weather file data in the [time series data viewer](#).

**Note.** You can also see the data after running a simulation on the Results page [data tables](#) and [time series graphs](#).

### Header Data from Weather File

Header data is information in the weather file that describes the location and type of data in the file. SAM uses the time zone, elevation, latitude and longitude to calculate the sun position during simulations. It does not use the city, state, country, and other descriptive information.

### Annual Values Calculated from Weather File

When you add a weather file to the solar resource library, SAM reads weather data from the file and calculates the annual values to display for your reference. It does not use annual values during simulations.

#### Global horizontal, Direct normal (beam), Diffuse horizontal

The sum of solar irradiance data (W/m<sup>2</sup>) in the weather file converted to kW and divided by 365 days/year.

#### Average temperature

The sum of temperature data (°C) in the weather file divided by the number of records in the file (8760 for hourly data).

#### Average wind speed

The sum of wind speed data (m/s) in the weather file divided by the number of records in the file (8760 for hourly data).



### Maximum snow depth

If the weather file contains snow depth data, the maximum value of snow depth data (cm) in the weather file. NaN indicates the file does not contain snow depth data. Snow depth data is required for to model snow losses for the Detailed Photovoltaic and PVWatts models.

**Note.** For information about where to find weather files with snow depth data, see the note on the [Weather Data](#) page of the SAM website.

### Annual albedo

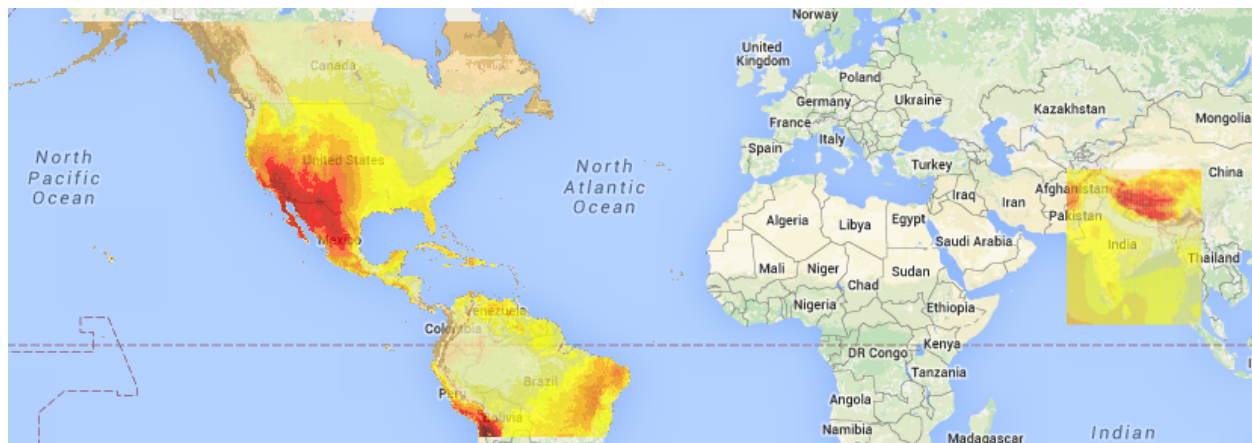
If the weather file contains albedo (ground reflectance) data, the average value of albedo values in the weather file. NaN indicates the file does not contain albedo data.

## ▼ About the NSRDB

The [NREL National Solar Radiation Database \(NSRDB\)](#) is an online database of weather files containing solar resource data in the [SAM CSV format](#). Files are available both as [typical-year](#) files and [single-year](#) files. The database covers the parts of the Americas and Asia shown in the map below. The current data is called PSM (Physical Solar Model) for the U.S., and SUNY for Asia. For details about the data see these pages on the NSRDB website:

- [U.S. data](#)
- [International data](#)

The NSRDB also contains legacy datasets for the U.S. from older versions of the NSRDB, including MTS3 (TMY3 1991-2010), MTS2 (TMY3 1991-2005), and MTS1 (TMY2 1961-1990). We recommend that you use the latest PSM data for your work in SAM, but the older data is available if you need it.



**Important Note for CSP Modelers!** SAM's CSP models assume that each DNI value in the weather file represents the average irradiance over the time step, and calculate sun angles for the midpoint of the time step. In weather files from the NSRDB, the irradiance data is measured instantaneously at either the beginning of the hour (TMY data), midpoint of the hour (single-year data), or beginning of the 30-minute time step (30-minute single-year data). As a result, if you use an NSRDB PSM weather file with a CSP model with either hourly TMY data or 30-minute single-year data, the sun angle for each time step will be for a different time than the time for the instantaneous irradiance values. See [Time Convention and Sun Position](#) for details.

**Notes.**

The NSRDB requires an email address to download weather file. When you download a weather file from SAM, SAM submits the email address that you used to [register SAM](#). NREL uses your email address to determine how many people are using the NSRDB. It does not share email addresses.

Different types of weather files in the NSRDB use different time conventions. See [Time Convention and Sun Position](#) for details.

When you download a file from the NSRDB website, SAM displays a "-" for the City, State, and Country fields because the NSRDB files do not contain that information. This will not affect simulation results. The location information SAM requires for simulations is latitude, longitude, elevation and time zone.

SAM uses the [Google Maps API Geocoding Service](#) service to identify the geographic coordinates (latitude and longitude) of a location when you type a street address or city and state name to identify the location.

For information about downloading weather files and data from other sources, see the [Weather Data](#) page on the SAM website.

SAM downloads weather files with the following hourly data from the NSRDB:

- Direct normal (beam) irradiance, DNI ( $W/m^2$ )
- Diffuse horizontal irradiance, DHI ( $W/m^2$ )
- Dry-bulb temperature ( $^{\circ}C$ )
- Dew-point temperature ( $^{\circ}C$ )
- Relative humidity (%), for single-year files only
- Atmospheric pressure (mbar)
- Wind speed at 2 meters above the ground (m/s)
- Wind direction ( $^{\circ}E$  of N)
- Albedo

**Note.** Weather files with snow depth data for the Detailed Photovoltaic model are not available from the NSRDB PSM dataset. They are available for 239 locations in the United States from the legacy [MTS1 \(TMY2\) files in the original format](#), which cover the period 1961 - 1990. See [Snow Losses](#) for details.

## Albedo - Sky Diffuse Model - Irradiance Data (Advanced)

The albedo, sky diffuse model, and irradiance data inputs are advanced inputs for the detailed photovoltaic model that you can ignore unless you have a reason to change them. These inputs are not available for the PVWatts model.

**Note.** Use the default **DNI and DHI** and **Perez** options unless you have a reason to change them.

**Definitions:**

**DNI:** Direct normal irradiance, sometimes called beam normal irradiance is the amount solar radiation per unit area that reaches a surface that is normal to the rays of solar radiation from the sun.

**DHI:** Diffuse horizontal irradiance is the solar radiation per unit area that reaches a horizontal surface from the sky dome, but not directly from the sun. DHI does not include solar energy reflected from the ground. SAM accounts for that separately using the albedo input described above.

**GHI:** Global horizontal irradiance is the total solar radiation per unit area that reaches a horizontal surface

**POA:** Plane of array, POA irradiance is equivalent to incident irradiance, and is the total solar radiation per unit area that reaches the surface of the photovoltaic array.

**Albedo**

SAM uses the albedo (also called ground reflectance) to make a small adjustment to the amount of irradiance incident on the array to represent irradiance reflected onto the array from the ground.

**Notes.**

For most analyses, you can use the default value of 0.2 assigned to each month.

The PVWatts model reads albedo data from the weather file if it is available. Otherwise, it uses a default value of 0.2.

After running a simulation, you can see the albedo value that SAM uses for simulations on the Results page.

**Monthly albedo**

The albedo value by month. SAM limits the albedo to values greater than zero and less than 1. The default value is 0.2, which is reasonable for grassy ground. A value of 0.6 would be reasonable for snow-covered ground.

A value of zero would mean that the ground is completely non-reflective, and a value of 1 would mean that it is completely reflective.

To see the monthly ground reflectance values, click **Edit Values**. To change the values, type a value for each month that you want to change. During a simulation, SAM applies the albedo value that you specify for a given month to each hour of that month.

**Use albedo in weather file if it specified**

Check this option if you want SAM to use hourly or subhourly albedo data from the weather file instead of the monthly albedo values. You should also specify monthly albedo values because SAM uses those values for any time steps that have values less than or equal to zero, or greater than or equal to one.

For each time step in the simulation, SAM checks the value in the albedo column of the weather file to see if it is between zero and one. If it is within that range, SAM uses that value for the albedo in that hour. If the value in the weather file is outside of that range for a given time step, then SAM uses the appropriate monthly albedo input value for that hour.

If you want to add albedo data to a weather file, you can edit the file using a text editor or spreadsheet software. See the [SAM CSV format description](#) for details.

## Diffuse Sky Model

SAM's detailed photovoltaic model uses DNI and DHI data with sun and subarray angles to calculate the irradiance incident on each subarray. Calculating the incident direct component from the DNI is straightforward, but there are several methods for estimating the incident diffuse component from DHI. The incident diffuse component includes both ground-reflected diffuse irradiance, and sky diffuse irradiance from the sky dome outside of the sun's circle. SAM allows you to choose the method it uses to convert DHI data to incident sky diffuse irradiance.

The isotropic model tends to under-predict the global radiation on a tilted surface, and is included as an option for analysis comparing SAM results with those from other models using this approach. The HDKR and Perez methods provide comparable estimates of the incident diffuse irradiance.

For more details about these methods, see the photovoltaic reference manual, which is available for download from the [SAM website](#).

### Isotropic

The isotropic method assumes that diffuse radiation is uniformly distributed across the sky, called isotropic diffuse radiation.

### HDKR

The Hay-Davies-Klucher-Reindl combination method accounts for the increased intensity of diffuse radiation in the area around the sun, called circumsolar diffuse radiation, in addition to isotropic diffuse radiation.

### Perez

The Perez method is the default value and is best for most analysis. It accounts for horizon brightening, circumsolar and isotropic diffuse radiation using a more complex computational method than the Reindl and Hay and Davies methods.

## Weather File Irradiance Data

A weather file in [SAM CSV format](#) for the photovoltaic performance models must contain at least two columns for the solar irradiance components or a single column for plane-of-array (POA) irradiance. The weather file may contain columns for all three irradiance components in addition to POA data. SAM determines which columns to use for the simulation based on the Weather File Irradiance Data options you choose.

Unless you choose one of the POA options, SAM's detailed photovoltaic model always requires the DNI and DHI components to calculate the irradiance incident on each subarray. When you choose the **DNI and GHI** or **GHI and DHI** options, SAM calculates values for the missing irradiance component from the two components that you specify, *even if the weather file contains data for the missing component*. When you choose a POA option, SAM bypasses the incident irradiance calculations.

### DNI and DHI

This is the default option, and is best for most analyses. SAM reads the direct normal irradiance (beam) and diffuse horizontal irradiance data from the weather file. For this option, SAM calculates incident irradiance using the DNI and DHI data from the weather file without any additional calculations.

### DNI and GHI

SAM reads the direct normal irradiance (beam) and global horizontal irradiance (total) data from the weather file, and calculates the diffuse horizontal irradiance values for simulations. SAM calculates the incident irradiance using the DNI data from the weather file and the calculated DHI data.

### GHI and DHI

SAM reads the global horizontal irradiance (total) and diffuse horizontal irradiance data from the weather file, and calculates direct normal irradiance values for simulations. SAM calculates the incident irradiance using DHI data from the weather file and the calculated DNI data.

### POA from reference cell

Use this option if your weather file contains irradiance data measured in the plane of the array by a reference photovoltaic cell that has the same optical characteristics as the cells in the array. SAM assumes that the POA data accounts for angle-of-incidence (AOI) effects and removes the calculation of AOI-related reduction in incident DNI from the performance model.

### POA from pyranometer

Use this option if your weather file contains irradiance data measured in the plane of the array by a pyranometer. SAM uses a POA decomposition model to calculate the DNI and DHI components of the POA irradiance for angle-of-incidence effect calculations.

#### Notes about the POA input options.

When you choose a POA option, SAM reports calculated DNI and DHI values in the results for your reference. It only uses the calculated DNI and DHI values under the following conditions:

With the **POA from pyranometer** option to calculate a reduction in DNI due to angle-of-incidence effects.

When you enable external shading, SAM applies the beam and diffuse irradiance shading factors to the calculated DNI and DHI values, and then calculates the irradiance incident on the subarray to account for shading.

When you use the CEC module model with the heat transfer method for temperature correction.

## Irradiance Data in Results

**Note.** If your weather file contains data for all three irradiance components, the value of the calculated third component that SAM uses for the simulation may differ from the value in the weather file.

You can see the calculated data on the Results page after running a simulation, for example, on the **Data tables** tab and **Time series** tab:

### Irradiance GHI/DNI/DHI/POA from weather file (W/m<sup>2</sup>)

The data in the weather file. If the column does not exist in the weather file, SAM reports the values in the results as NaN (not a number).

### Irradiance GHI/DNI/DHI calculated (W/m2)

The values of the third irradiance component that SAM calculates from the other two in the weather file. For example, if you choose the **DNI and GHI** option, you should see **Irradiance DHI calculated** in the results. SAM uses the following equations for the calculated values, where  $z$  is the sun zenith angle:

$$GHI = DHI + DNI \times \cos(z)$$

$$DHI = GHI - DNI \times \cos(z)$$

$$DNI = (GHI - DHI) \div \cos(z)$$

For the POA options, SAM calculates the DHI and DNI values from the POA data in the weather file using the method described in Marion, B. (2015) "A model for deriving the direct normal and diffuse horizontal irradiance from the global tilted irradiance." Solar Energy, vol. 122, pp. 1037-1046.

### Subarray [ $n$ ] POA total irradiance after shading and soiling (W/m2)

The total irradiance incident on each subarray  $n$ .

## 8.2 PV System Costs

The PV System Costs page provides access to variables that define the installation and operating costs of a photovoltaic project. Debt-related and tax costs are specified on the [Financial Parameters](#) page.

SAM uses the variables on the PV System Costs page to calculate the project investment cost and annual operating costs reported in the project [cash flow](#) and used to calculate cost metrics.

Variable values in boxes with white backgrounds are values that you can edit. Boxes with blue backgrounds contain calculated values or values from other pages that SAM displays for your information.

SAM provides the categories under **Direct Capital Costs** and **Indirect Capital Costs** for your convenience to help keep track of project installation costs. Only the **Total Installed Cost** value affects the cash flow calculations, so you can assign capital costs to the different cost categories in whatever way makes sense for your analysis. For example, you could assign the cost of designing the array to the module cost category or to the engineering category with equivalent results. After you assign costs to the categories, you should verify that the total installed cost value is what you expect. SAM accounts for the total installed cost in Year 0 of the project [cash flow](#).

The Operation and Maintenance Costs categories are where you specify recurring project costs. SAM reports these annual costs in the project [cash flow](#) under the Operating Expenses heading.

#### Notes.

The default cost values that appear when you create a file or case are intended to illustrate SAM's use. The cost data are meant to be realistic, but not to represent actual costs for a specific project. For more information and a list of online resources for cost data, see the technology pages on the [SAM website](#).

The System Costs page only available for cases with a cash-flow-based financial model. It is not available with the No Financial Model option or the LCOE Calculator financial model.

## Direct Capital Costs

A direct capital cost represents an expense for a specific piece of equipment or installation service that applies in year zero of the cash flow.

**Note:** Because SAM uses only the total installed cost value in cash flow calculations, how you distribute costs among the different direct capital cost categories does not affect the final results.

### Module Cost (\$/Wdc or \$/Unit)

For the detailed photovoltaic model, the module cost is expressed per unit or per DC Watt:

- Dollars per DC watt multiplied by **Nameplate Capacity (at reference conditions)** on the [System Design](#) page, or
- Dollars per unit multiplied by Total Modules on the System Design page.

For PVWatts, the module cost is expressed per unit or per DC Watt:

- Dollars per watt multiplied by **Nameplate Capacity** on the [PVWatts System Design](#) page, or
- Dollars per unit, where the number of modules is assumed to be one.

### Inverter (\$/Wac or \$/Unit)

For the detailed photovoltaic model, the cost of inverters in the system is expressed in dollars per AC Watt or dollars per inverter:

- Dollars per AC watt multiplied by **Total Inverter Capacity** on the [System Design](#) page, or
- Dollars per unit multiplied by **Number of Inverters** in the **Actual Layout** column on the System Design page.

For PVWatts, the inverter cost is either dollars per watt or dollars per inverter:

- Dollars per watt multiplied by the product of **DC Rating** and **DC to AC Derate Factor** on the [System Design](#) page, or
- Dollars per unit where the number of inverters is assumed to be one.

### Battery (\$/kWh, \$/kW)

For the battery models, the battery installation cost is expressed in \$/kWh of total battery capacity, \$/kW of maximum charge/discharge power, or both. Specify the battery replacement cost separately using the cost under **Operation and Maintenance Cost** at the bottom of the System Costs page.

PV Battery:

- Dollars per kilowatt-hour multiplied by **Nominal bank capacity** on the Battery Cell and System page.
- Dollars per kilowatt multiplied by the **Maximum charge power** on the Battery Cell and System page.

PVWatts Battery:

- Dollars per kilowatt-hour multiplied by **Battery capacity** on the [System Design](#) page.
- Dollars per kilowatt multiplied by the **Battery power** on the [System Design](#) page.

## Balance of System, Installation Labor, Margin and Overhead

The other direct capital cost categories, **Tracking Equipment** (HCPV only), **Balance of system**, **Installation labor**, and **Installer margin and overhead** can be specified using three units. SAM calculates the total amount for each category as shown below.

**\$**

A fixed cost in dollars.

**\$/Wdc**

A cost proportional to the system's DC nameplate capacity, equal to the **Nameplate Capacity** on the [System Design](#) page for the detailed photovoltaic model, or the **DC Rating** on the [PVWatts System Design](#) page for the PVWatts model.

**\$/m2**

Applies only to the detailed photovoltaic model. A cost proportional to the total module area of the array in square meters, equal to the **Total Area** on the [System Design](#) page. This option is not active for the PVWatts model.

**Contingency (%)**

A percentage of the sum of the equipment, balance of system, installation labor, and installer margin and overhead costs that you can use to account for expected uncertainty in the direct cost estimates.

**Total Direct Cost (\$)**

The sum of equipment, system, installation labor, installer margin and overhead costs, and contingency costs.

**Indirect Capital Costs**

An indirect cost is typically one that cannot be identified with a specific piece of equipment or installation service.

**Note:** Because SAM uses only the total installed cost value in cash flow calculations, how you distribute costs among the different indirect capital cost categories does not affect the final results.

The five indirect cost categories, **Permitting - Environmental Studies**, **Engineering**, **Grid interconnection** are each calculated as the sum of the three values expressed with the following units:

**% of Direct Cost**

A percentage of the **Total Direct Cost** value shown under Direct Capital Costs.

**Cost \$/Wdc**

A cost proportional to the system's DC nameplate capacity, equal to the **Nameplate Capacity** on the [System Design](#) page for the detailed photovoltaic model, or the **DC Rating** on the [PVWatts System Design](#) page for the PVWatts model.

**Fixed Cost**

A fixed cost in dollars.

**Total**

For each category, the total is the sum of the three units:



$$\text{Total} = \% \text{ of Direct Cost} \times \text{Total Direct Cost (\$)} + \text{Cost \$/Wdc} \times \text{Nameplate Capacity (Wdc)} + \text{Fixed Cost (\$)}$$

## Land Costs

SAM calculates the total land cost as the sum of **Land** and **Land Preparation**. The land cost categories use the Cost \$/acre category in addition to the categories for the other indirect costs (% of Direct Cost, Cost \$/Wdc, Fixed Cost).

### Total Land Area

The total land area from the [System Design](#) page.

### Cost \$/acre

A cost in dollars per acre of total land area.

### Total

For each land cost category, the total is the sum of the three units:

$$\text{Total} = \text{Cost \$/acre} + \% \text{ of Direct Cost} \times \text{Total Direct Cost (\$)} + \text{Cost \$/Wdc} \times \text{Nameplate Capacity (Wdc)} + \text{Fixed Cost (\$)}$$

## Sales Tax (%)

### Sales tax basis, %

The percentage of total direct cost used to calculate sales tax amount.

SAM calculates the total sales tax amount by multiplying the sales tax rate from the [Financial Parameters](#) page by the sales tax basis on the System Costs page:

$$\text{Total Sales Tax (\$)} = \text{Sales Tax Rate (\%)} \times \text{Sales Tax Basis (\%)} \times \text{Total Direct Cost (\$)}$$

For an explanation of the effect of sales tax on income tax, see **Sales Tax** on the [Financial Parameters](#) topic for the financial model you are using (Residential, Commercial, Single Owner, etc.)

## Total Indirect Cost (\$)

The sum of the five indirect cost categories and the sales tax.

## Total Installed Cost

The total installed cost is the sum of all of the direct and indirect capital costs that you specify. SAM uses this value to calculate the project's [net capital cost](#), which is the total installed cost less any cash incentives on the [Incentives](#) page and plus any additional financing costs from [Financial Parameters](#) page.

### Total installed cost (\$)

The sum of total direct cost and total indirect cost.

### Total installed cost per capacity (\$/Wdc or \$/kW)

Total installed cost divided by the total system rated or nameplate capacity. This value is provided for reference only. SAM does not use it in cash flow calculations.

## Operation and Maintenance Costs

Operation and Maintenance (O&M) costs represent annual expenditures on equipment and services that occur after the system is installed. SAM allows you to enter O&M costs in three ways: Fixed annual, fixed

by capacity, and variable by generation. O&M costs are reported on the project [cash flow](#) in Years 1 and later..

For each O&M cost category, you can specify an optional annual **Escalation Rate** to represent an expected annual increase in O&M cost above the annual inflation rate specified on the [Financial Parameters](#) page. For an escalation rate of zero, the O&M cost in years two and later is the year one cost adjusted for inflation. For a non-zero escalation rate, the O&M cost in years two and later is the year one cost adjusted for inflation plus escalation.

For expenses such as component replacements that occur in particular years, you can use an annual schedule to assign costs to individual years. See below for details.

**Fixed annual cost (\$/yr)**

A fixed annual cost that applied to each year in the project cash flow.

**Fixed cost by capacity (\$/kW-yr)**

A fixed annual cost proportional to the system's rated or nameplate capacity.

**Variable cost by generation (\$/MWh)**

A variable annual cost proportional to the system's total annual electrical output in AC megawatt-hours. The annual energy output depends on either the performance model's calculated first year value and the **degradation rate** from the [Lifetime](#) page, or on an annual schedule of costs, depending on the option chosen.

For systems with include battery storage:

**Battery replacement cost**

The battery replacement cost in Year 1 dollars per kWh of installed battery capacity. SAM uses the inflation rate from the [Financial Parameters](#) page to calculate the replacement cost in the replacement year.

**Note.** To include battery replacements costs in your analysis, be sure to choose a battery replacement option on the [Battery Storage](#) page.

## Specifying O&M Costs in Specific Years

SAM allows you to specify any of the four operation and maintenance (O&M) cost categories on the System Costs page either as a single annual cost, or using a table of values to specify an annual schedule of costs. An annual schedule makes it possible to assign costs to particular years in the analysis period. Annual schedules can be used to account for component replacement costs and other periodic costs that do not recur on a regular annual basis.

You choose whether to specify an O&M cost as a single annual value or an annual schedule with the grey and blue button next to each variable. SAM uses the option indicated by the blue highlight on the button: A blue highlighted "Value" indicates a single, regularly occurring annual value. A blue highlighted "Sched" indicates that the value is specified as an annual schedule.

For example, to account for component replacement costs, you can specify the fixed annual cost category as an annual schedule, and assign the cost of replacing or rebuilding the component to particular years. For a 30-year project using a component with a seven-year life, you would assign a replacement cost to years seven, 14, and 21. Or, to account for expected improvements in the component's reliability in the future, you could assign component replacement costs in years seven, 17, and 27. After running a simulation, you can see the replacement costs in the project [cash flow](#) in the appropriate column under Operating Expenses. SAM accounts for the operating costs in the other economic metrics including the levelized cost of energy

and net present value (NPV).

#### Notes.

If you use the annual schedule option to specify equipment replacement costs, SAM does not calculate any residual or salvage value of system components based on the annual schedule. SAM calculates salvage value separately, using the salvage value you specify on the [Financial Parameters](#) page.

Dollar values in the annual schedule are in nominal or current dollars. SAM does not apply inflation and escalation rates to values in annual schedules.

The following procedure describes how to define the fixed annual cost category as an annual schedule. You can use the same procedure for any of the other operation and maintenance cost categories.

#### **To assign component replacement costs to particular years:**

1. In the Fixed Annual Cost category, note that the "Value" label of the grey and blue button is blue indicating that the single value mode is active for the variable.

Fixed Annual Cost   \$/yr

In this case, SAM would assign an annual cost of \$284 to each year in the project cash flow.

2. Click the button so that "Sched" label is highlighted in blue. SAM replaces the variable's value with an Edit button.

3. Click **Edit** to open the [Edit Schedule](#) window.
4. In the Edit Schedule window, use the vertical scroll bar to find the year of the first replacement, and type the replacement cost in current or constant dollars for that year.  
To delete a value, select it and press the Delete key on your keyboard.

**Note.** You must type a value for each year. If you delete a value, SAM will clear the cell, and you must type a number in the cell or SAM will consider the schedule to be invalid. Type a zero for years with no annual costs.

5. When you have finished editing the schedule, click **Accept**.

Because you must specify an O&M cost category as either an annual cost or annual schedule, to assign both a recurring annual fixed cost and periodic replacement cost, you must type the recurring cost in each year of the annual schedule, and for years with replacement costs, type the sum of the recurring and replacement costs.

## 8.3 Edit Shading Data

The Edit Shading Data window is where you define beam and sky diffuse shading losses. To open the window, click **Edit Shading** from either the Detailed Photovoltaic Model's [Shading and Layout](#) page, or from the PVWatts model [System Design](#) page.

**Note.** For more information about the shading options, see [Shading and Layout](#).

Each shading loss is a percentage that represents the portion of the solar radiation component (either beam or diffuse) that is prevented from reaching the array by a nearby shading object:

- SAM reduces the plane-of-array beam irradiance (direct normal irradiance) in each hour by the beam shading loss for that hour. Beam irradiance is solar energy that reaches the array in a straight line from the sun.  
For example, for a beam shading loss of 10% for the 8 a.m. hour of December 20, SAM would reduce the beam radiation value in the weather file by 10% for that hour, and use that reduced value to calculate the total incident radiation on the array for that hour.
- If you use the [time series beam shading loss table](#), you can enable the partial shading model that will estimate the reduction in the subarray's DC output due to partial shading of the subarray. You should use this option only for subarrays with crystalline Silicon modules, and with up to 8 strings of modules.
- SAM reduces the incident sky diffuse irradiance for each hour by the sky diffuse shading loss. Sky diffuse radiation is radiation that reaches the array from the sun indirectly after being reflected by clouds and particles in the atmosphere. Sky diffuse radiation does not include diffuse radiation reflected from the ground. Note that you can only specify a single constant value that applies to all hours of the year for the sky diffuse shading loss.

## Import Shading Files

SAM allows you to import shading data from the following software:

- PVsyst, photovoltaic system design software, <http://www.pvsyst.com>
- Solmetric SunEye, shading analysis device, <http://www.solmetric.com>
- Solar Pathfinder, shading analysis device, <http://www.solarpathfinder.com>

## Importing Data from PVsyst

You can import a "Near Shadings" table generated by PVsyst into SAM. SAM automatically imports data from the text file generated by PVsyst into the Solar Azimuth by Altitude Shading loss table and the diffuse shading loss value.

**Notes.** We have tested the following procedure with Version 5 of PVsyst.

The "Near Shadings" table in PVsyst looks like this:

Azimuth	-180°	-160°	-140°	-120°	-100°	-80°	-60°	-40°	-20°	0°	20°	40°	60°	80°	100°	120°	140°	160°	180°
90°	1.000	1.000	1.000	1.000	1.000	1.000	1.000	1.000	1.000	1.000	1.000	1.000	1.000	1.000	1.000	1.000	1.000	1.000	1.000
80°	1.000	1.000	1.000	1.000	1.000	1.000	1.000	1.000	1.000	1.000	1.000	1.000	1.000	1.000	1.000	1.000	1.000	1.000	1.000
70°	1.000	1.000	1.000	1.000	1.000	1.000	1.000	1.000	1.000	1.000	1.000	1.000	1.000	1.000	1.000	1.000	1.000	1.000	1.000
60°	1.000	1.000	1.000	1.000	1.000	1.000	1.000	1.000	0.989	0.984	0.989	1.000	1.000	1.000	1.000	1.000	1.000	1.000	1.000
50°	1.000	1.000	1.000	1.000	1.000	1.000	1.000	0.978	0.958	0.952	0.958	0.978	1.000	1.000	1.000	1.000	1.000	1.000	1.000
40°	1.000	1.000	1.000	1.000	1.000	1.000	1.000	0.977	0.924	0.917	0.924	0.977	1.000	1.000	1.000	1.000	1.000	1.000	1.000
30°	1.000	1.000	1.000	1.000	1.000	1.000	1.000	0.977	0.900	0.900	0.900	0.977	1.000	1.000	1.000	1.000	1.000	1.000	1.000
20°	Behind	1.000	1.000	1.000	1.000	1.000	1.000	0.977	0.900	0.900	0.900	0.977	1.000	1.000	1.000	1.000	1.000	1.000	Behind
10°	Behind	Behind	Behind	1.000	1.000	1.000	1.000	0.977	0.900	0.900	0.900	0.977	1.000	1.000	1.000	1.000	1.000	1.000	Behind
2°	Behind	Behind	Behind	Behind	1.000	1.000	1.000	0.977	0.900	0.900	0.900	0.977	1.000	1.000	1.000	1.000	1.000	1.000	Behind

Shading factor for diffuse: 0.977 and for albedo: 0.935

The "Near Shadings" data exported to a text file looks like this (in this example with semicolon delimiters):

```
Shading factor table (linear), for the beam component:
Azimuth:-180°;-160°;-140°;-120°;-100°;-80°;-60°;-40°;-20°; 0°; 20°; 40°; 60°; 80°; 100°; 120°; 140°; 160°; 180°;
Height:
90°:1.000;1.000;1.000;1.000;1.000;1.000;1.000;1.000;1.000;1.000;1.000;1.000;1.000;1.000;1.000;1.000;1.000;1.000;1.000;1.000;
80°:1.000;1.000;1.000;1.000;1.000;1.000;1.000;1.000;1.000;1.000;1.000;1.000;1.000;1.000;1.000;1.000;1.000;1.000;1.000;1.000;
70°:1.000;1.000;1.000;1.000;1.000;1.000;1.000;1.000;1.000;1.000;1.000;1.000;1.000;1.000;1.000;1.000;1.000;1.000;1.000;1.000;
60°:1.000;1.000;1.000;1.000;1.000;1.000;1.000;1.000;1.000;1.000;1.000;1.000;1.000;1.000;1.000;1.000;1.000;1.000;1.000;1.000;
50°:1.000;1.000;1.000;1.000;1.000;1.000;1.000;1.000;1.000;1.000;1.000;1.000;1.000;1.000;0.997;0.991;0.999;1.000;1.000;1.000;1.000;
40°:1.000;1.000;1.000;1.000;1.000;1.000;1.000;1.000;1.000;1.000;1.000;1.000;0.989;0.961;0.962;0.988;1.000;1.000;1.000;1.000;1.000;
30°:1.000;1.000;1.000;1.000;1.000;1.000;1.000;1.000;1.000;1.000;1.000;1.000;0.932;0.898;0.914;0.975;0.999;1.000;1.000;1.000;1.000;
20°:1.000;1.000;1.000;1.000;Behind;Behind;1.000;1.000;1.000;1.000;0.922;0.823;0.808;0.849;0.959;0.999;1.000;1.000;1.000;1.000;
10°:1.000;1.000;Behind;Behind;Behind;Behind;Behind;Behind;1.000;1.000;0.819;0.629;0.698;0.780;0.938;0.999;1.000;1.000;1.000;1.000;
2°:1.000;Behind;Behind;Behind;Behind;Behind;Behind;Behind;Behind;Behind;1.000;0.783;0.502;0.639;0.754;0.921;0.999;1.000;1.000;1.000;
Shading factor for diffuse: 0.968 and for albedo: 0.820;
```

**To import a "Near Shadings" table from PVsyst:**

1. In PVsyst, follow the procedure to create and export a "Near Shadings" table. The table in PVsyst should look similar to the one below. SAM will recognize any of the delimiter options: tab, comma, or semicolon.
2. In SAM, click **Edit shading** (on the [PV Shading and Layout](#) page or [PVWatts System Design](#) page) to open the Edit Shading Data window, and click the **PVsyst near shading** and navigate to the folder containing the shading file.  
When SAM imports data from the file, it displays the message "Azimuth-Altitude Table and Diffuse loss update" and populates the azimuth-altitude shading table, the sky diffuse shading loss, and enables both options.
3. Disable any shading options that do not apply to your analysis.

**Importing from Solmetric SunEye**

The Solmetric SunEye software generates shading data in two formats: The obstruction table, which characterizes shading using an altitude-azimuth angle table to indicate solar positions that are blocked by nearby obstructions, and the hourly shading file, which lists hourly beam radiation shading factors. SAM can read data from both tables.

Use the obstruction table if you plan to model the system for different locations (assuming the same shading obstructions). Use the hourly shading loss table if you plan to model the system for a single location.

**Note.** If you use the hourly shading loss table, be sure that the weather data specified on the [Location and Resource](#) page is for the same location as the one where the SunEye measurements were made.

#### **To import a SunEye obstruction table:**

1. In the Solmetric SunEye software (not the PV Designer software), on the **File** menu, click **Export Session Report and Data**.

The SunEye software creates a set of files, and assigns a default name like *Sky01ObstructionElevations.csv* to the obstruction data file. By default, the files are in a folder named *ExportedFiles* in the exported report folder.

2. In SAM, click **Edit shading** (on the Detailed Photovoltaic model's [Shading and Layout](#) page or the PVWatts [System Design](#) page) to open the Edit Shading Data window, and click **Suneye obstructions table**, and navigate to the folder containing the file you want to import.
3. Open the obstruction data file for any of the available skies (*Sky01ObstructionElevations*, *Sky02ObstructionElevations*, etc.).

If the average or worst case obstruction data from multiple skylines will be used, then an extra step is required. In a spreadsheet program, open the *ObstructionElevation* file containing the average and maximum values as well as all skylines in the SunEye session. Make sure that the desired data (average or maximum) is in the third column, delete the other columns, and save the file as .csv with a name like *ObstructionElevationsAVG.csv*. Use this file as the obstruction data file in SAM.

SAM displays the message "Azimuth-Altitude Table updated," populates the azimuth-altitude shading loss table, and enables the **Enable solar azimuth by altitude beam irradiance shading loss** option.

4. Be sure to enable and disable the other shading options as appropriate.

#### **To import a SunEye hourly shading file:**

1. In the Solmetric SunEye software (not the PV Designer software), on the **File** menu, click **Export Session Report and Data**.

The SunEye software creates a set of files, and assigns a default name like *Sky01Shading.csv* to the hourly shading file. By default, the files are in a folder named *ExportedFiles* in the exported report folder.

2. In SAM, click **Edit shading** (on the Detailed Photovoltaic model [Shading and Layout](#) page or PVWatts [System Design](#) page) to open the Edit Shading Data window, and click **Suneye hourly shading**, and navigate to the folder containing the shading file.
3. Open the shading file for any of the available skies (*Sky01Shading*, *Sky02Shading*, etc.). To use average shading for multiple skylines, open *AverageShading.csv*.

SAM displays the message "Hourly Shading Factors for Beam Radiation updated," populates the hourly shading loss table, and enables the **Enable Hourly Beam Shading Factors** option.

4. To see the hourly data, click **Edit Data** under **Hourly Shading Factors for Beam Radiation**.
5. Be sure to enable and disable the other shading options as appropriate.
6. On the [Location and Resource](#) page, choose a weather file for the same location represented by the SunEye shading data.

## Importing from SolarPathfinder Assistant

The SolarPathfinder Assistant software generates shading data in two formats: The obstruction table, which characterizes shading using an altitude-azimuth angle table to indicate solar positions that are blocked by nearby obstructions, and the hourly shading file, which lists hourly beam radiation shading factors. SAM can read data from both tables.

Use the obstruction table if you plan to model the system for different locations (assuming the same shading obstructions). Use the hourly shading loss table if you plan to model the system for a single location.

**Note.** If you use the month-by-hour shading loss table, be sure that the weather data specified on the Location and Resource page is for the same location as the one where the Solar Pathfinder measurements were made.

### **To import a Solar Pathfinder obstruction table:**

1. In SolarPathfinder Assistant, on the File menu, click **Export, Horizon Angles**.
2. In the Save window, specify the location and name of the data file.
3. In SAM, click **Edit shading** (on the Detailed Photovoltaic model [Shading and Layout](#) page or PVWatts [System Design](#) page) to open the Edit Shading Data window, and click **Solar Pathfinder obstructions**, and navigate to the folder containing the file you want to import.
4. Open the obstruction data file you saved in Step 2.  
SAM displays the message "Azimuth-Altitude Table updated," populates the azimuth-altitude shading loss table, and enables the Enable Azimuth-Altitude Shading Factors for Beam Radiation option.
5. Be sure to enable and disable the other shading options as appropriate.

### **To import a Solar Pathfinder Month by Hour shading file:**

1. In SolarPathfinder Assistant, on the File menu, click **Export, Shading Data**.
2. In the Save window, specify the location and name of the data file.
3. In SAM, click **Edit shading** (on the Detailed Photovoltaic model [Shading and Layout](#) page or PVWatts [System Design](#) page) to open the Edit Shading Data window, and click **Solar Pathfinder month by hour shading**, and navigate to the folder containing the shading file.
4. Open the shading file you saved in Step 2.  
SAM displays the message "Hourly Shading Factors for Beam Radiation updated," populates the hourly shading loss table, and enables the Enable Hourly Beam Irradiance Shading Losses option.
5. To see the hourly data, click **Edit Data** under **Enable hourly beam irradiance shading losses**.
6. Be sure to enable and disable the other shading options as appropriate.
7. On the Location and Resource page, choose a weather file for the same location represented by the Solar Pathfinder shading data.

## Beam Irradiance Shade Loss Tables

SAM provides the three options described below to specify beam irradiance shading loss: Time series, month by hour, and solar azimuth by solar altitude.

Typically, you would enable only one of the three options. However, if you enable more than one option, SAM combines the losses you enabled for each hour to calculate a total shading loss.

**Tip.** If you plan to import time series, month-by-hour, or azimuth-by-altitude shading data from text files, you can see the correct file format by exporting existing data (even if it is all zeros). You can use the exported file as an example for your data.

## Time Series Beam Irradiance Shade Loss Table

The time series option allows you define a beam shading loss for each simulation time step. The data's time convention should follow that of the weather file. For the standard TMY files, Hour 1 is the hour ending at 1 a.m. on Monday, January 1.

For the Detailed Photovoltaic performance model, for subarrays with crystalline Silicon modules and up to eight strings of modules, SAM provides an option to model partial shading of the subarray. For more information about the partial shading model, see MacAlpine, S.; Deline, C. (2015) Simplified Method for Modeling the Impact of Arbitrary Partial Shading Conditions on PV Array Performance. National Renewable Energy Laboratory. 8 pp.; NREL/CP-5J00-64570. ([PDF 699 KB](#))

You can use SAM's [3D shade calculator](#) to generate loss values for the time series beam irradiance shade loss table.

### To specify time series beam shading factors:

1. Check **Enable beam irradiance shading losses by time step**.
2. For **Time step in minutes**, enter the time step of the weather file. For hourly data, choose 60 minutes.
3. If you are modeling a system with crystalline silicon modules, check **Enable partial shading model (c-Si modules only)** to estimate the impact of partial shading on the subarray's DC output.  
If you have separate shading data for each string in the subarray, for **Strings in Subarray [n]** enter the number of strings in parallel from the [System Design](#) page. If the subarray has more than eight strings, or you do not have shading data for individual strings, enter a one to model losses for a single string.

For thin-film modules, or to model the effect of partial shading as a linear relationship between the beam shading loss (size of shadow on subarray) and the subarray's DC output, do not enable the partial shading model.

Once you define a table of hourly shading losses, you can clear the **Enable hourly beam irradiance shading losses** check box to run a simulation with no losses without losing the shading losses data.

## Month by Hour Beam Irradiance Shade Loss Table

**Note.** You can use the [3D shade calculator](#) to [automatically generate month-by-hour shade factors](#) from a three-dimensional drawing of the array and nearby objects.

### To specify month by hour shading factors:

1. Check **Enable month by hour beam irradiance shading factors**.
2. Type shading data into the table, or import it from a text file.



To the month-by-hour shading loss matrix is a 24-by-12 table containing a set of 24 hourly shading losses for each month of the year. The shading loss in a cell applies to a given hour for an entire month.

- The data's time convention should follow that of the weather file. For the standard TMY files, the value in the first row and column is for the hour ending at 1 a.m. for all days in January.
- A red cell indicates a value of 100%, or full shading (beam radiation completely blocked).
- A white cell indicates a value of zero, or no shading.
- A dark shade of red indicates more shading (less beam irradiance) than a light shade of red.

#### **To define a shading loss for a single cell:**

- Click the cell and type the shading loss percentage.
- To replace the value in a cell, click the cell and type a replacement value.
- To delete the value from a cell, double-click the cell and press the Delete key.

#### **To define a single shading loss for multiple cells:**

- Use your mouse to select the cells to which you want to apply the shading loss percentage.
- Type a value between zero and one.
- Press the Enter key or click **Apply to selected cells**.

#### **To import or export month-by-hour beam shading factors:**

SAM allows you to import and export the shading loss matrix as a comma-delimited text file that contains 12 rows of 24 hourly shading factors separated by commas. The file should not have row or column headings.

To see an example of the correct file format, export the default shading table to a text file and open it with a text editor.

- To export the shading matrix as a text file, click **Export**. SAM saves the file with the .csv extension.
- To import a data from a comma-delimited text file, click **Import**. You can open a correctly formatted text file with any extension, although SAM expects a .csv file by default.

## **Solar Azimuth by Altitude Beam Irradiance Shade Loss Table**

The solar azimuth-by-altitude table is a two-dimensional look-up table of beam irradiance shading losses. For each hour in the simulation, SAM calculates the position of the sun as a pair of solar azimuth and altitude angles and looks up the shading loss to use for that hour based on the solar position. SAM uses linear interpolation to estimate the value of the shading loss for solar angles that fall between values in the table row and column headings.

- Azimuth angle values use the following convention: 0 = north, 90 = east, 180 = south, 270 = west.

#### **To define the azimuth-altitude shading loss table by hand:**

1. Click **Enable solar azimuth by altitude beam irradiance shading loss table**.
2. In **Rows** and **Cols**, type the number of rows (solar altitude angle values) and number of columns (solar azimuth angle values) in the table.

Specify a number of rows that is one greater than the number of altitude values: For example for a table with nine rows of altitude values, specify a **Rows** value of 10. Similarly, specify a **Cols** value that is one greater than the number of azimuth values.

3. In the top row (highlighted in blue), type a set of solar azimuth angle values in degrees between zero and 360 and increasing monotonically from left to right.
4. In the leftmost column (highlighted in blue), type a set of solar altitude values in degrees between zero and 90 and increasing monotonically from top to bottom.
5. Type a beam shading loss percentage (between zero and 100%) in each cell of the table. A value of 100% indicates that beam irradiance is fully blocked by a shading object. A value of zero indicates that beam irradiance is not blocked.

#### **To import or export azimuth-by-altitude beam shading factors:**

SAM allows you to import and export the azimuth-altitude lookup table as a comma-delimited text file that contains shading percentages separated by commas. The file should also include the row and column headings indicating the solar azimuth and altitude values.

To see an example of the correct file format, export the default shading table to a text file and open it with a text editor.

- To export the shading table as a text file, click **Export**. You can save the file with any file extension, including *.txt* or *.csv*.
- To import data from a comma-delimited text file, click **Import**.

## **Sky Diffuse Shade Loss**

SAM provides a single input for a constant sky diffuse loss that it applies to every hour in the year. It represents portion of the sky that is obstructed. A value of zero is for no shading loss, a value of 100% completely blocks sky diffuse irradiance from the array.

#### **To define a sky diffuse shading loss:**

1. Click **Enable sky diffuse shading loss (constant)**.
2. Type a value for the shading loss as a percentage.

## **8.4 PV Sizing and Configuration**

SAM's two photovoltaic models offer different approaches to sizing the system:

For [PVWatts](#), you specify a nameplate DC capacity in kilowatts and a DC to AC sizing ratio. Because PVWatts can scale the size of the array and inverter, it can model any size of system. This makes PVWatts a good model when you need a reasonable estimate of a system's production before you know what kind of modules and inverters you will use, or when you just need an estimate of the production based on the size of a system.

For the [Detailed Photovoltaic model](#), you choose a module and inverter, and then specify the number of modules in a string, and number of strings in the array. You can also divide the array into sections called subarrays to model an array with modules oriented in different directions, or that use different tracking

options. Sizing the system in the Detailed Photovoltaic model requires more effort, because you have to choose a appropriate module and inverter for the system, and determine the number of modules and inverters you need for a given DC capacity and DC to AC ratio while ensuring that the array voltages are within the inverter's voltage limits.

## Sizing the System in the Detailed Photovoltaic Model

SAM provides two options on the [System Design](#) page for specifying the numbers of modules and inverters in the PV system:

- The best way is to [specify the number of modules and inverters](#) yourself.
- If you are modeling a system with one subarray, you can check [Estimate Subarray 1 configuration](#), and see what values SAM calculates for the number modules per string and number of strings in parallel.

For information about how SAM models inverter clipping losses, see [Inverter Clipping Loss](#). You can run the **System Sizing macro** to generate a detailed report about clipping losses and the inverter's MPPT performance.

### Configuration Examples

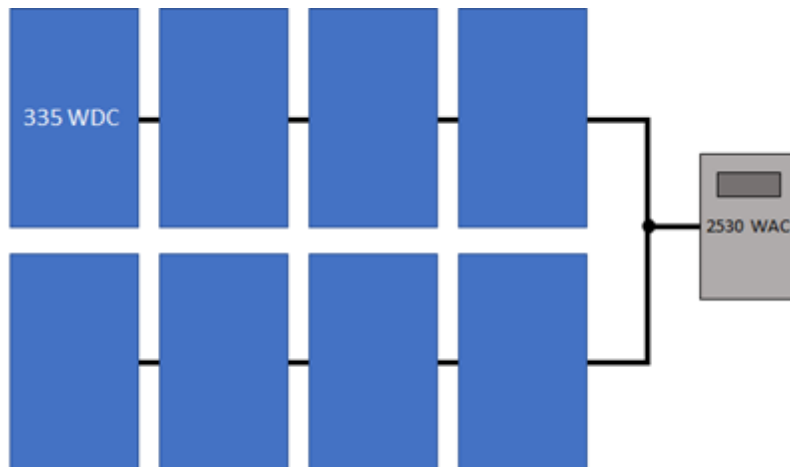
The following examples show how to design common system configurations in SAM. The examples show a few modules for a small system for clarity, but the same approach can be used for large systems with thousands of modules and multiple inverters. See [Microinverters](#) for a microinverter configuration example.

#### Example 1: One string, one inverter, one MPPT



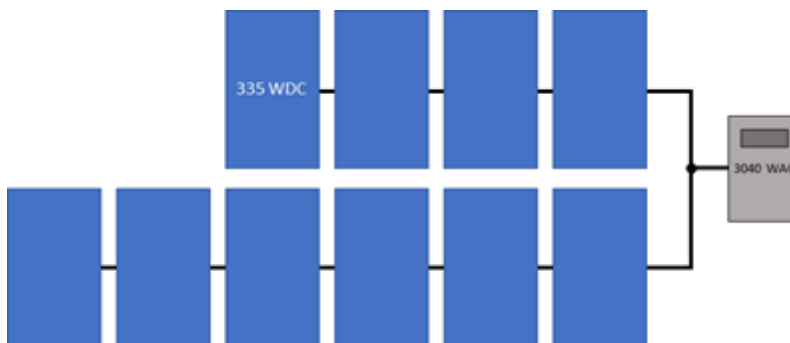
Number of MPPT inputs	1
Number of inverters	1
Modules per string in subarray 1	4
Strings in parallel in subarray 1	1

#### Example 2: Two identical strings, one inverter, one MPPT



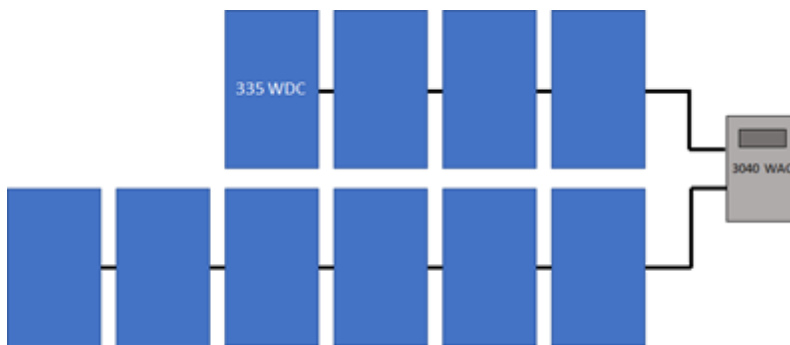
Number of MPPT inputs	1
Number of inverters	1
Modules per string in subarray 1	4
Strings in parallel in subarray 1	2

**Example 3: Two different strings, one inverter, one MPPT**



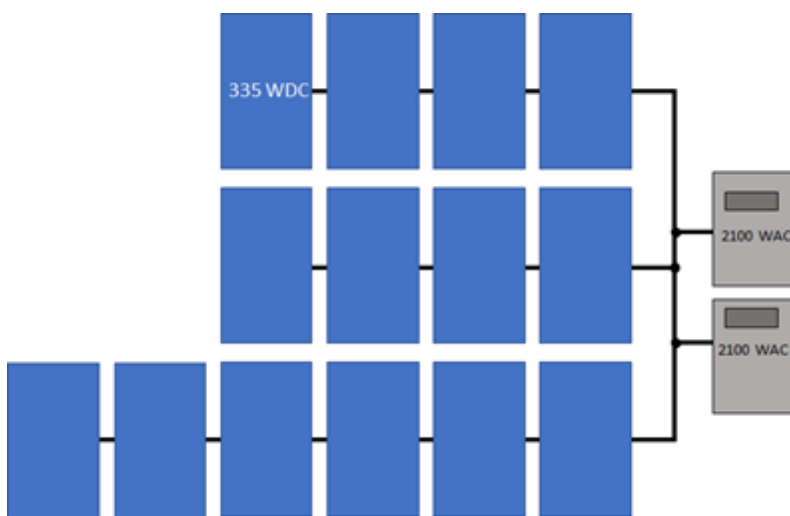
Number of MPPT inputs	1
Number of inverters	1
Modules per string in subarray 1	4
Strings in parallel in subarray 1	6

**Example 4: Two different strings, one inverter, two MPPTs**

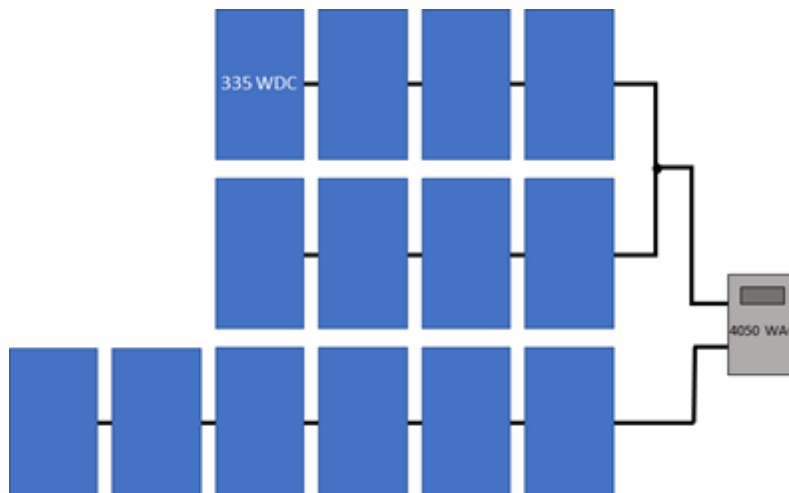


Number of MPPT inputs	2
Number of inverters	1
Modules per string in subarray 1	4
Strings in parallel in subarray 1	6
Inverter MPPT input for subarray 1	1
Inverter MPPT input for subarray 2	2

**Example 5: Three strings (two identical), two inverters, one MPPT**



Number of MPPT inputs	1
Number of inverters	2
Modules per string in subarray 1	4
Strings in parallel in subarray 1	2
Modules per string in subarray 2	6
Strings in parallel in subarray 2	1

**Example 6: Three strings (two identical), one inverter, two MPPTs**

Number of MPPT inputs	2
Number of inverters	1
Modules per string in subarray 1	4
Strings in parallel in subarray 1	2
Modules per string in subarray 2	6
Strings in parallel in subarray 2	1

**Specify Numbers of Modules and Inverters**

The following instructions explain one approach for choosing optimal values for the numbers of modules and inverters based on the array's expected DC output instead of its nameplate capacity.

**Note.** The System Sizing macro generates a report that you can use to compare the system's operating characteristics to design values, and generates a list of alternative modules that might work with the inverter you chose.

**To specify numbers of modules and inverters by hand:**

1. Choose an inverter for the system or specify its parameters on the [Inverter](#) page. (For microinverters, see [Modeling Microinverters](#).) If you do not have a specific inverter in mind, either choose one with a rated maximum DC power close to the array size you want to model, or choose one with a maximum AC power that is your desired array DC capacity divided by your desired DC to AC ratio.
2. Choose a module or specify its parameters on the [Module](#) page. If you do not have a specific module in mind, use the default module.
3. On the [System Design](#) page, under **AC Sizing**, for **Number of Inverters**, type 1.

- Under **DC Sizing and Configuration**, for Subarray 1, type a value for **Modules per string in subarray** that results in a string open circuit voltage (**String Voc**) less than but as close as possible to the inverter's maximum DC input voltage, and greater than the inverter's minimum MPPT voltage. For an initial estimate, you can try an integer value less than:

$$\text{Modules per String} = [ ( \text{Minimum MPPT Voltage} + \text{Maximum MPPT Voltage} ) \div 2 ] \div \text{Module Maximum Power Voltage}$$

If the resulting string open circuit DC voltage (**String Voc**) is greater than the inverter's maximum DC voltage, reduce the number of modules per string. You may also want to try a similar module or inverter with slightly lower or higher maximum power.

- For **Strings in Parallel in subarray**, type a value that results in an array nameplate capacity that is close to your desired system DC capacity. You can choose an integer value close to the value:

$$\text{Strings in Parallel} = \text{Array Nameplate Capacity (kWdc)} \times 1000 \text{ (W/kW)} \div \text{Module Maximum Power (Wdc)} \div \text{Modules Per String.}$$

- Depending on the inverter you chose, you may need to modify the number of inverters to match the array size.

$$\text{Number of Inverters} = ( \text{Modules per String} \times \text{Strings in Parallel} \times \text{Module Maximum Power (Wdc)} ) \div ( \text{DC-to-AC Ratio} \times \text{Inverter Maximum AC Power (Wac)} )$$

You may need to experiment with different sizes of modules and inverters within the same family to find a combination that works for your system.

- Under **Tracking & Orientation**, specify the tracking and orientation and ground coverage ratio as appropriate.
- On the [Losses](#) page, specify any losses.
- [Run a simulation](#). See below for details about any simulation [notices](#).
- On the [Results](#) page, check the [energy yield](#) (kWh/kW) in the [Metrics table](#) to make sure it is a reasonable value. (For example, the energy yield for the default system based on mono-crystalline modules in Phoenix, Arizona is about 1,850 kWh/kW.) If it seems too low, check that the total inverter capacity is not too low and limiting the system's AC output. If it is, you may want to try using a larger inverter, fewer modules, or a module from the same family with slightly lower capacity.
- Also on the Results page, click the [Time Series](#) tab.

Display the Hourly Energy variable. This is the system's AC output in kWh/h. You can use this information to decide whether to reduce the inverter capacity. For example if you specified a 400 kW inverter capacity, but the time series data indicates the system rarely operates at that level, you could try reducing the number of inverters to model a system with 315 kW of inverter capacity to reduce the system's installation cost.

Display the Subarray 1 open circuit voltage and operating voltage variables. You can use these to verify that the array voltage does not exceed your design voltage limits.

- Adjust the numbers of inverters, modules per string, and strings in parallel, and run more simulations until you are satisfied with the cost and performance of the system.

## Estimate Subarray 1 Configuration

This option is appropriate for very preliminary analyses to get a rough idea of a system's annual output, or as a first step in determining the number of modules per string, strings in parallel, and number of inverters for your system.

**Note.** SAM's array sizing calculator works best for systems with a nameplate DC capacities of greater than about 20 kW. It only works for systems with one subarray (Subarray 1).

The array sizing calculator estimates the number of modules and inverters required for the array size and DC-to-AC ratio that you specify. It uses the nominal specifications of the modules and inverters from the [Module](#) and [Inverter](#) pages to calculate values for the numbers of modules per string, strings in parallel, and inverters. Because SAM makes the calculation before running a simulation, it has no information about the expected output of the array for these calculations. However, SAM does display [notices](#) based on the expected output of the photovoltaic array and inverter that you can use to refine the array size.

#### **To size the photovoltaic array with the array sizing assistant:**

1. Choose an inverter or specify its parameters on the [Inverter](#) page. (For microinverters, see [Modeling Microinverters](#).)
2. Choose a module or specify its parameters on the [Module](#) page.
3. On the [System Design](#) page, under **AC Sizing**, check **Estimate Subarray 1 configuration**.
4. Type the array DC capacity value in kilowatts for **Desired array size**.
5. Type the ratio of DC array capacity to AC inverter capacity for **Desired DC to AC ratio**.  
SAM calculates and displays values for **Modules per String**, **Strings in Parallel**, and **Number of Inverters**
6. Verify that **Nameplate Capacity** under **Modules** and **Total capacity** under **Inverters** are acceptably close to the desired values, and check the sizing messages for any information to help you adjust your assumptions.  
If the capacity is not as close to the desired value, you can try choosing a slightly smaller or larger module or inverter to get closer to the desired capacity. Because these capacity values are based on a multiple of the module and inverter capacities, SAM will probably not be able to suggest a system with your exact nameplate capacity value.
7. If the values for the inverter maximum DC voltage, or inverter minimum MPPT voltage and maximum MPPT voltage are zero, see the note below.
8. Under **Tracking & Orientation**, choose options to specify the module tracking, orientation and ground coverage ratio as applicable.
9. On the Losses page, specify any DC or AC losses. You can use default values if you do not have specific loss values for your system design.

### **PV Array Sizing Calculator Algorithm**

The array sizing calculator uses the following algorithm to determine the number of modules and inverters in the array:

1. *Choose an initial number of modules per string that results in a string maximum power voltage close to the midpoint between the inverter minimum MPPT voltage and maximum MPPT voltage.*
2. *If the resulting string open circuit voltage exceeds the inverter maximum DC input voltage, reduce the number of modules per string by one until the string voltage is less than the inverter limit.*
3. *Calculate the number of strings in parallel required to meet the desired array capacity.*
4. *Calculate the number of inverters required to meet the DC-to-AC ratio you specify.*

The algorithm uses the following rules to size the array:

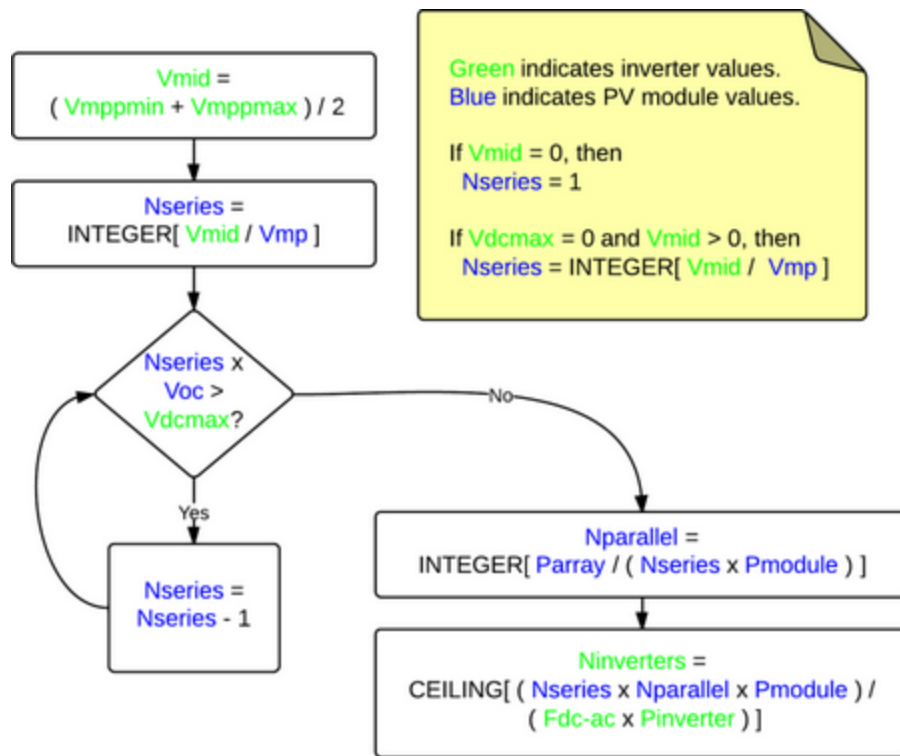
- The string open circuit voltage (Voc) is less than the inverter's maximum DC voltage.



- The ratio of the array's nameplate capacity in DC kW to the inverter total capacity in AC kW is close to the DC-to-AC ratio that you specify.

For the inverters in the CEC database with missing voltage limits:

- If the inverter minimum MPPT voltage and maximum MPPT voltage values are not available, then the number of modules per string is one.
- If the inverter maximum DC voltage is not available, but the minimum and maximum MPPT voltage values are, then the number of modules in series is determined from the MPPT voltage limits and the module maximum power voltage (see flowchart for details).



**Flowchart of the PV Array Sizing Calculator Algorithm**

Where:

$V_{dcmax}$	Inverter maximum DC voltage
$V_{mppmin}$	Inverter minimum MPPT voltage
$V_{mppmax}$	Inverter maximum MPPT voltage
$V_{mid}$	Midpoint between inverter minimum and maximum MPPT voltages
$P_{inverter}$	Inverter maximum AC power
$F_{dc-ac}$	DC-to-AC ratio
$V_{oc}$	String open circuit voltage
$V_{mp}$	String maximum power voltage
$P_{module}$	Module maximum DC power
$N_{series}$	Number of modules in series

*Nparallel*      Number of strings in parallel

## Working with Subarrays

When you create a new case for the Detailed Photovoltaic model, SAM creates a system with one subarray. If you are modeling a system as a single array, you do not need to enable any other subarrays.

To model a system that consists of multiple subarrays, check **Enable** for each additional Subarray 2, 3, or 4.

For example, to configure strings for a 10 MW system consisting of SunPower SPR-305 modules, and Advanced Energy Solaron 333 inverters with two subarrays of 5 MW each with different azimuth angles:

1. On the [Module](#) and [Inverter](#) pages, choose the SunPower module and Solaron inverter, respectively.
2. On the [System Design](#) page, under **AC Sizing**, type 4 for **Number of inverters**.
3. Clear **Estimate Subarray 1 configuration**. It is not possible for SAM to automatically size a system with more than one subarray.
4. Under **DC Sizing and Configuration**, for **Subarray 1**, specify 8 modules per string and 220 strings in parallel, and an azimuth angle of 180.
5. Enable Subarray 2, and specify 8 modules per string and 220 strings in parallel for Subarray 2, and an azimuth angle of 170.

### **Notes.**

You can enable any combination of subarrays. For example, you can model a system with two subarrays by enabling Subarrays 1 and 3, and disabling Subarrays 2 and 4.

SAM can only model systems with one type of module, and one type of inverter. You cannot use subarrays to model a system that combines different types of modules or inverters.

Modeling multiple subarrays may be useful for the following applications:

- A residential or commercial rooftop system with modules installed on different roof surfaces with different orientations or string lengths.
- A ground-mounted system with groups of modules installed at different orientations, with different string lengths, DC wiring lengths, or exposed to different shading scenes or soiling conditions.
- A system that combines different tracking systems

## 8.5 Microinverters

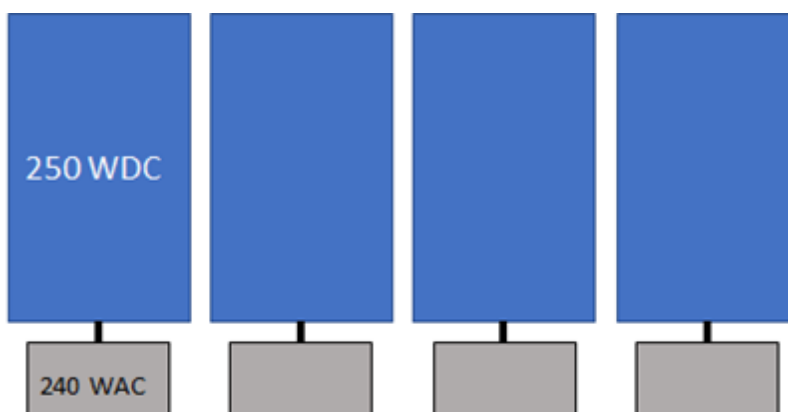
A microinverter is an inverter designed to be connected to a single module. A PV system with microinverters has a single inverter for each module, rather than the more traditional single inverter connected to the array or to individual strings of modules. Microinverters track each module's maximum power point independently, and minimize shading and module mismatch losses associated with string inverters.

**Notes.**

SAM assumes that all modules in the array operate at their maximum power point. The electrical loss associated with module voltage mismatch is an input on the [Losses](#) page. When you model a system with microinverters, you should change the mismatch loss to zero as described in the procedure below.

SAM's self-shading model does not account for MPPT tracking of individual modules and is not suitable for use with microinverters.

The example below is for a small system with microinverters, but the approach would be the same for a large system with thousands of modules and microinverters.



Number of MPPT inputs	1
Number of inverters	4
Modules per string in subarray 1	1
Strings in parallel in subarray 1	4

**To model a system with using microinverters in the Detailed Photovoltaic model:**

1. On the [Inverter](#) page, choose the [CEC Database inverter model](#). Sort inverter list by Paco to find a microinverter with a power rating suitable for your application. You can also type the first few letter of the manufacturer name to find the inverter you want to model. If your inverter is not in the list, choose the [Inverter Datasheet model](#) to enter inverter parameters from the manufacturer data sheet.
2. On the [Module](#) page choose a module mode, choose a module matched with the microinverter. You can sort the list by STC to sort the list by module power rating.  
Compare the module's maximum power (Pmp) rating to the inverter's maximum DC power rating, and the module maximum power voltage (Vmp) to the inverter's nominal DC voltage rating to match the components.  
Consult the manufacturer data sheet or design guidelines for more specific details.
3. On the [System Design](#) page, clear **Estimate Subarray 1 configuration** if it is checked.
4. For Subarray 1, for **Modules per String in subarray**, enter 1.
5. To subarray 1's **Strings in Parallel in subarray**, divide the system's nameplate capacity by the module maximum power rating (Pmp) from the [Module](#) page:

*Strings in Parallel = System Nameplate Capacity (Wdc) / Module Maximum Power (Wdc)*

6. Under **AC Sizing** (at the top of the page), for **Number of Inverters**, enter the value you calculated for the number of strings in parallel:  
*Number of Inverters = Strings in Parallel*
7. On the [Losses](#) page, for **Module Mismatch**, enter zero. You can also click **Microinverters** to apply default loss values.
8. On the [PV System Costs](#), be sure that the inverter cost is appropriate for the microinverter.
9. On the [Shading and Layout](#) page, be sure to clear the **Enable Self-Shading Calculator** check box.

## 8.6 Detailed Photovoltaic Model

The following overview is to help you get started modeling a photovoltaic system with the detailed photovoltaic model. For a description of the model, see [Performance Models](#).

For a complete technical description of SAM's photovoltaic model, see Gilman, P. (2015). SAM Photovoltaic Model Technical Reference. National Renewable Energy Laboratory. 59 pp.; NREL/TP-6A20-64102. ([PDF 840 KB](#))

### Basic Steps

#### 1. Choose a weather file

- On the [Location and Resource](#) page, choose a weather file to represent the solar resource at the project location.

#### 2. Specify the system's characteristics

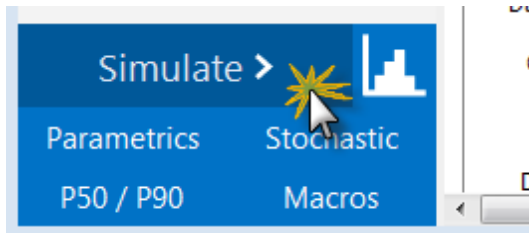
1. On the [Module](#) page, choose a model option and module.  
For most applications, use the CEC Performance Model with Module Database model unless your module is not in the list, in which case you can use the CEC Performance Model with User Specifications.
2. On the [Inverter](#) page, choose a model option and inverter.  
Use the Inverter CEC Database option. For an inverter that is not in the list, if you have the manufacturer's data sheet, choose the Inverter Datasheet model.
3. On the [System Design](#) page, specify the system's size and array tracking options.  
Use the specify desired array size option for preliminary analysis, and then use specify modules and inverters to refine the system design.
4. If you want to account for shading losses, use the [Shading and Layout](#) page for external shading by nearby objects, array self-shading, or to account for losses due to the array being covered by snow when your weather data includes snow depth data.
5. Account for soiling losses, DC power losses, AC power losses, and losses due to system availability requirements on the [Losses](#) page. You can use the default values if you do not have detailed information about those losses for your system.

## 5. Specify the project costs

- On the [System Costs](#) page, specify values for capital cost and operation and maintenance costs.

## 6. Run a simulation and review results

- Click Simulate, and review [results](#) on the [Results Page](#).



## Post-simulation Notices

After completing a simulation, SAM checks to see whether the inverter appears to be over- or under-sized based on the actual DC output of the array. If it finds any problems, it displays [notices](#) after simulations are complete.

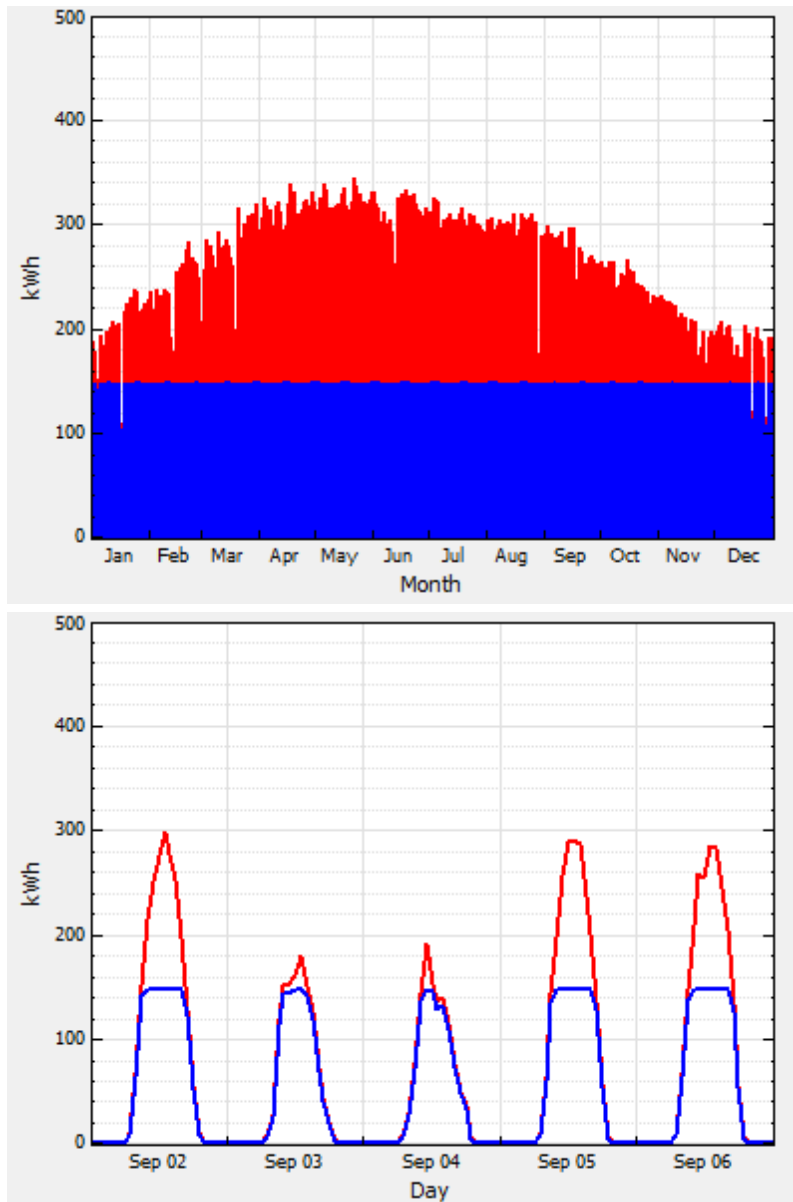
Post-simulation checks include:

- *Inverter undersized:* The array output is greater than inverter rated capacity for one or more of the 8,760 hours in one year. SAM reports the number of hours that the array's simulated DC output is greater than the inverter's AC rated capacity.

If the number of hours is small compared to the 8,760 hours in a year, you may choose to ignore the message. Otherwise, you may want to try increasing the inverter capacity.

For example, for a system with 400 kWdc array capacity and 150 kWac total inverter capacity, SAM displays the following warning message: "pvsamv1: Inverter undersized: The array output exceeded the inverter rating 157.62 kWdc for 2128 hours."

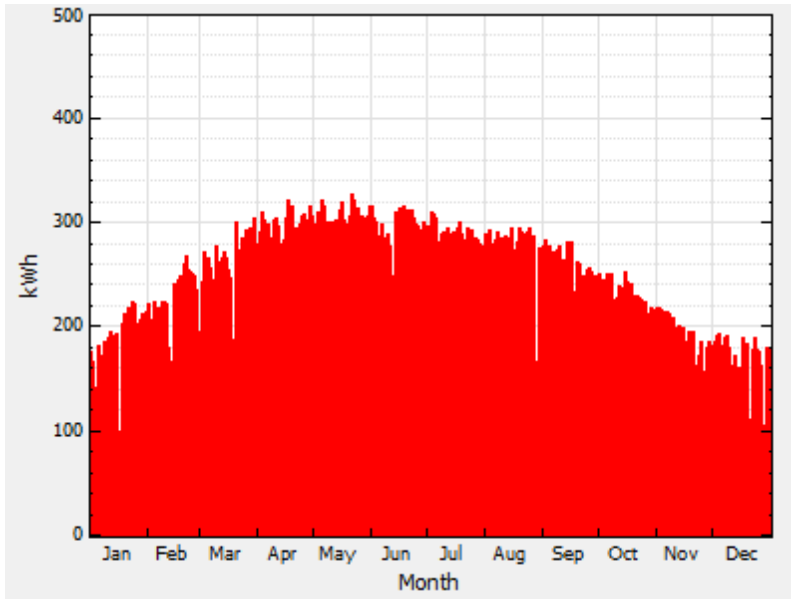
The following [time series graphs](#) show the array's DC output in red, and the system's AC output in blue, indicating that the inverter capacity is limiting the system's AC output:



- *Inverter output less than 75 percent of inverter rated capacity.* SAM compares the inverter's maximum AC output to the total inverter AC capacity and displays a simulation warning if the inverter's maximum AC output is less than 75% of the total inverter rated AC capacity.

For example, for a system with 400 kWdc array capacity and 750 kWac inverter capacity, SAM displays the following warning message: "pvsamv1: Inverter oversized: The maximum inverter output was 43.13% of the rated value 750 kWac."

In this case, the time series graph of gross AC output shows that the inverter output never reaches the 750 kWac capacity.

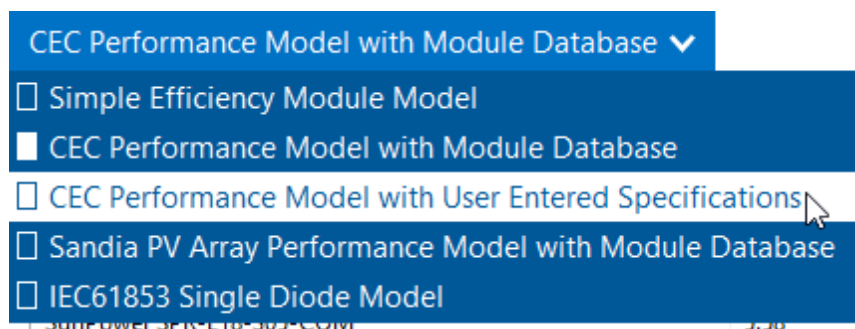


### 8.6.1 Module

The Module page allows you to choose a model to represent the photovoltaic module's performance. For each time step of the simulation, the module model calculates the DC electrical output of a single module based on the design parameters and the incident solar radiation (plane-of-array irradiance) calculated from data in the [weather file](#).

SAM assumes that the system is made up of an array of identical modules, which can be wired into up to four DC subarrays. The photovoltaic array's electric output depends on the number of modules in the system and the orientation, tracking, shading, and other parameters on the [System Design](#) page, and any losses you specify on the [Shading and Layout](#) and [Losses](#) pages. The array's electrical output is fed to a bank of one or more inverters, whose characteristics appear on the [Inverter page](#).

SAM displays the name of the active module model at the top of the Module page. Click the model name to choose a different model:



You can choose from five different module performance models:

- [Simple Efficiency Module Model](#) is a simple representation of module performance that requires you to provide the module area, a set of conversion efficiency values, and temperature correction

parameters. The simple efficiency model is the least accurate of the three models for predicting the performance of specific modules, but is useful for analyses involving explorations of the relationship between module efficiency and the system's performance and cost of energy because it allows you to specify the module efficiency as an input.

- [CEC Performance Model with Module Database](#) calculates module solar energy-to-electricity conversion efficiency from data stored in a library of module parameters for thousands of commercially available modules. It is an implementation of the six-parameter single-diode equivalent circuit model used in the California Energy Commission New Solar Homes Partnership Calculator, and is an extension of the five-parameter originally developed model developed at the University of Wisconsin.
- [CEC Performance Model with User Entered Specifications](#) uses the same algorithms as the CEC model with Module Database, but allows you to enter your own module specifications from a manufacturer's data sheet.
- [Sandia PV Array Performance Model with Module Database](#) calculates module conversion efficiency based on data measured from modules and arrays in realistic outdoor operating conditions. The database includes modules with different cell types, including crystalline silicon, and various thin film technologies. It is an empirically-derived model developed by Sandia National Laboratories.
- [IEC61853 Single Diode Model](#) calculates the module conversion efficiency from a set of detailed parameters describing the module's characteristics, consistent with the International Electrotechnical Commission (IEC) power and rating standard, [IEC 61853](#), *Irradiance and Temperature Performance Measurements and Power Rating*.

For a complete technical description of SAM's photovoltaic model, see Gilman, P.; Dobos, A.; DiOrto, N.; Freeman, J.; Janzou, S.; Ryberg, D. (2018) SAM Photovoltaic Model Technical Reference Update. 93 pp.; NREL/TP-6A20-67399 available along with other technical documentation from the [SAM website](#).

**Note.** You can also model a photovoltaic system using the simpler [PVWatts model](#), or a high concentration photovoltaic (HCPV) system using the [concentrating photovoltaic model](#). To use these models you must [choose the models](#) when you create a new file or case. (You can also [choose a different](#) model for the current case.)

## CEC Performance Model with Module Database

The California Energy Commission (CEC) Performance Model uses the University of Wisconsin-Madison Solar Energy Laboratory's five-parameter single-diode model with a database of module parameters for modules from the database of eligible photovoltaic modules maintained by the California Energy Commission (CEC) for the California Solar Initiative.

The five-parameter single-diode model calculates a module's current and voltage under a range of solar resource conditions (represented by an I-V curve) using an equivalent electrical circuit whose electrical properties can be determined from a set of five reference parameters. These five parameters, in turn, are determined from standard reference condition data provided by either the module manufacturer or an independent testing laboratory, such as the Arizona State University Photovoltaic Testing Laboratory.



**Notes.**

SAM's CEC module library contains parameters for the modules in the List of Eligible SB1 Guidelines Compliant Photovoltaic Modules at [http://www.gosolarcalifornia.org/equipment/pv\\_modules.php](http://www.gosolarcalifornia.org/equipment/pv_modules.php) as of the date of the SAM software release for the current version.

If you represent a module manufacturer and would like to add your module to the CEC database, you should contact the CEC directly. See <http://www.gosolarcalifornia.ca.gov/equipment/add.php>.

To model a module that is not in the database, you can use the [CEC Performance Model with User Entered Specifications](#).

The five-parameter single-diode model is described in Gilman, P. (2015). SAM Photovoltaic Model Technical Reference. National Renewable Energy Laboratory. 59 pp.; NREL/TP-6A20-64102. ([PDF 840 KB](#)), and in De Soto 2004, [Improvement and Validation of a Model for Photovoltaic Array Performance](#), Master of Science Thesis, University of Wisconsin-Madison.

**To use the CEC photovoltaic model:**

1. On the Module page, choose **CEC Performance Model**.
2. Choose a module from the list of available modules. SAM displays the model's characteristics and model coefficients.

When you select a module from the CEC database on the Module page, SAM displays module's parameters. You can see the complete set of parameters in the Module library by using SAM's [library editor](#).

**Module Characteristics at Reference Conditions**

The characteristics at reference conditions are module ratings, and as such are nominal values. During a simulation, SAM calculates module parameters under operating conditions, which you can see in the [Results](#).

**Reference conditions**

The total irradiance and cell temperature at which the rated module characteristics apply.

**Nominal efficiency, %**

The module's rated efficiency at reference conditions. SAM displays this value for reference only. During a simulation, the model calculates an efficiency value for each hour, which you can see in the time series output data.

**Maximum Power (Pmp), Wdc**

The module rated power. Equal to the product of the maximum power voltage and maximum power current.

**Max Power Voltage (Vmp), Vdc**

Reference maximum power voltage at the reference conditions.

**Max Power Current (Imp), Adc**

Reference maximum power current at the reference conditions.

**Open Circuit Voltage (Voc), Vdc**

Reference open circuit voltage at the reference conditions.

**Short Circuit Current (Isc), Adc**

Reference short circuit current at the reference conditions.

**Temperature Coefficients**

SAM displays the temperature coefficients in %/°C and W/°C at maximum power, open circuit, and short circuit.

The temperature coefficients are based on data collected from laboratory test results and may not match coefficients provided by the manufacturer on the module's data sheet.

**Bifacial Specifications**

SAM's bifacial model is adapted from Marion, B, et. al (2017) A Practical Irradiance Model for Bifacial PV Modules, available for download from the [SAM website](#). The model's open source implementation is available on the NREL GitHub website at <https://github.com/NREL/bifacialv1>. The bifacial model calculates the plane-of-array irradiance on the rear side of the PV modules in the array assuming infinite rows. The rear-side plane-of-array irradiance is multiplied by the module bifaciality factor, and then added to the front-side plane-of-array irradiance, which is then sent to the module model to predict module DC power. Primary drivers of the rear-side POA irradiance include the ground albedo, row-to-row spacing (function of ground-coverage ratio), and ground clearance height.

**Module is bifacial**

Check this box to enable the bifacial model and its inputs.

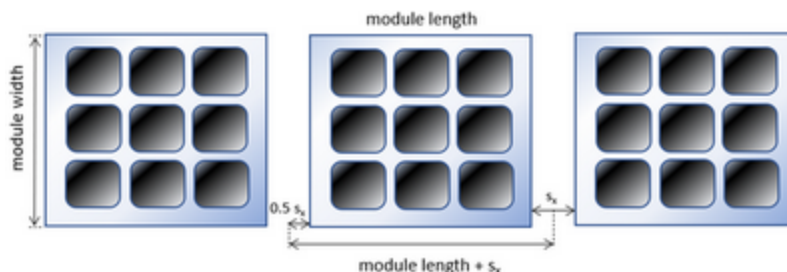
**Note.** The CEC module library indicates whether the module is bifacial. You can sort the library table by clicking the Bifacial column heading: Bifacial modules have a value of one.

**Transmission Fraction**

The ratio of array area that prevents light from reaching the surface behind the array to the area that lets light through as a fraction between 0 and 1. For modules made of glass or other transparent material that allows light to pass through the module between cells, the ratio would be the total cell area divided by the total array area. For modules with an opaque back, the ratio would be the total module area divided by the total array area.

For example, given the diagram below of a rectangular array of modules that allow light to pass both in the space between cells and the space between modules, the transmission factor would be:

$$\text{Transmission Factor} = \text{Total Cell Area (m}^2\text{)} / [ (\text{Module Length (m)} + S_x \text{(m)}) \times \text{Module Width (m)} ]$$



**Note.** The module dimensions you use for this calculation should be consistent with any dimensions you use elsewhere in SAM, such as for shading calculations.

### **Bifaciality**

The ratio of rear-side efficiency to front-side efficiency. Typically a value between 0.65 and 0.9 provided on the bifacial module datasheet.

### **Ground clearance height**

The height from the ground to the bottom of the PV array. For systems with tracking, this is the height at a zero-degree tilt angle.

## **Temperature Correction**

The CEC model provides two modes for modeling the effect of cell temperature on module performance:

### **The Nominal operating cell temperature (NOCT) method**

This method determines the cell temperature based on the nominal operating cell temperature (NOCT) specified in the module parameters. In SAM 2010.11.9 and earlier versions, this was the only available temperature correction option for the CEC mode. De Soto (2004) listed on the [PV Publications](#) page of the SAM website.

#### **Mounting standoff**

Choose the option that best describes how the module is mounted: Ground or rack mounted when there is a when there is a lot of space between the module back and the ground or roof surface; For roof-mounted modules, choose a distance between the module back and roof in inches; or choose building-integrated for a module that is part of the building structure.

For standoff heights less than 0.5 inches, and between 0.5 inches and 3.5 inches, SAM increases the NOCT value by several degrees as the standoff height decreases to account for reduced airflow between the module and roof surface. This is the same approach as is used in the [CECPV Calculator Spreadsheet](#).

#### **Array height**

Choose the option that best describes the height of the array from the ground.

## **Transient Thermal Model Correction**

When the simulation time step determined by the number of records in the weather file is 20 minutes or less, SAM automatically applies a correction to account for temperature changes driven by wind speed and the mass of the module using the method described in Prilliman (2020) listed on the [PV Publications](#) page of the SAM website..

#### **Module unit mass, kg/m<sup>2</sup>**

The mass of the module in kilograms per square meter of module area. The default value is 11 kg/m<sup>2</sup>.

## **Heat transfer method**

The heat transfer method uses a steady state heat transfer model to calculate cell temperatures described in Neises (2010). When the simulation time step is less than 20 minutes and you choose the gap mounting configuration for the heat transfer model, it applies the transient weighted average model for the back surface-temperature described in Prilliman (2020). References to both publications are available under "Module/Cell Temperature Models" on the [PV Publications](#) page of the SAM website.

**Notes.**

The temperature correction algorithms use wind speed and ambient (dry-bulb) temperature data from the weather file, assumed to be measured at 2 meters above the ground. The heat transfer method also uses atmospheric pressure and wet-bulb temperature data.

When you specify a vertical or horizontal mounting structure option, SAM also uses wind direction data in the cell temperature calculation.

**Mounting configuration**

Choose the option that best describes how the modules are mounted: Rack when modules are mounted on open racks that allow ambient air to flow freely over the front and back of the modules; Flush when modules are in direct contact with a roof or wall, preventing air from flowing over the back of the module; Integrated when modules form part of the roof or wall so that the back of the module is in contact with the indoor air (when you specify integrated mounting, you must also specify the temperature behind the module); Gap for modules that are mounted with a space between the module and building surface that allows limited air flow over the back of each module (when you specify gap mounting, you must also specify the mounting structure orientation and gap spacing).

The mounting configuration affects the movement of air around the module and the transfer of heat between the module and the building surface or ground. SAM assumes that all modules in the array use the same mounting configuration.

**Heat transfer dimensions**

Choose whether you want SAM to calculate the cell temperature based on the module or array dimensions. The Array Dimensions option assumes that modules in the array are in direct contact with each other and results in a higher calculated cell temperatures than the Module Dimensions option. Use the Array Dimensions option for more conservative array output estimates.

**Mounting structure orientation**

This option is only available for the gap mounting configuration only. Choose how the mounting structure interferes with airflow under the modules for the gap mounting configuration: None if the mounting structure does not impede air flow over the back of the modules; vertical supporting structures if the mounting structures on module back are perpendicular to the roof ridge and impede air flow parallel to the ridge; or horizontal supporting structures if the mounting structures are parallel to the roof ridge and impede air flow perpendicular to the ridge.

**Module width**

Length of side of module parallel to the ground.

**Module length**

SAM calculates this value by dividing the module area from the parameter library by the module width that you specify.

$$\text{Module Height (m)} = \text{Module Area (m}^2\text{)} \div \text{Module Width}$$

When you choose array dimensions for the heat transfer dimensions, you must also specify how modules are physically configured in the array.

**Rows of modules in array (array heat transfer dimensions only)**

Assuming a rectangular array, the number of rows of modules, where a row is parallel to the line defined by the Module Width variable.

**Columns of modules in array (array heat transfer dimensions only)**

Assuming a rectangular array, the number of modules along the side perpendicular to the line defined by the module width variable.

**Note.** The rows and columns of modules variables are independent of the similar variables on the [System Design](#) page and [Shading and Layout](#) page. Before running a simulation, verify that the values on the different pages are consistent.

**Temperature behind the module (integrated mounting configuration only)**

The indoor air temperature for the integrated mounting configuration option. SAM assumes a constant indoor air temperature.

**Spacing between module back and roof surface (gap mounting configuration only)**

The distance between the back of the modules and the roof or wall surface for the gap mounting configuration option.

**Physical Characteristics****Material**

A description of the semiconductor technology used in the photovoltaic cells.

1-a-Si: single-junction amorphous silicon

2-a-Si: dual-junction amorphous silicon

3-a-Si: triple-junction amorphous silicon

a-Si/nc: amorphous silicon - microcrystalline silicon tandem module

CdTe: cadmium telluride

CIGS: copper indium gallium sulfide

CIS: copper indium diselenide

HIT-Si: amorphous silicon heterojunction

Mono-c-Si: single-crystal silicon

Multi-c-Si: multi-crystalline silicon

**Module area**

The total area of the module, including spaces between cells and the frame.

**Number of cells**

Number of cells per module.

**Additional Parameters****T\_noct**

Nominal operating cell temperature

**A\_ref**

Modified ideality factor at reference conditions

**I\_L\_ref**

Photocurrent at reference conditions

**I\_o\_ref**

Reverse saturation current at reference conditions

**R\_s**

Series resistance (constant)

**R\_sh\_ref**

Shunt resistance at reference conditions

## ▼ Sandia PV Array Performance Model with Module Database

The Sandia PV Array Performance model consists of a set of equations that provide values for five points on a module's I-V curve and a database of coefficients for the equations whose values are stored in the Sandia Modules library. The coefficients have been empirically determined based on a set of manufacturer specifications and measurements taken from modules installed outdoors in real, operating photovoltaic systems.

**Note.** SAM's Sandia module library contains parameters for modules involved in [Sandia's Test and Evaluation program](#). If you represent a module manufacturer and would like to add your equipment to the Sandia database, you should [contact the program](#).

The Sandia model is described in King et al, 2004. Photovoltaic Array Performance Model. Sandia National Laboratories. SAND2004-3535. ([PDF 1.8 MB](#)). Also see the [Sandia PV Modeling and Analysis](#) website for more on PV system performance modeling.

### **To use the Sandia photovoltaic model:**

1. On the Module page, choose **Sandia PV Array Performance Model with Module Database**.
2. Choose a module from the list of available modules. Use the search box to filter the list. Click a column heading in the list to sort by name or parameter value.  
SAM displays the module's characteristics and model coefficients.  
When you choose a module from the list, SAM displays the module characteristics at reference conditions on the Module page. Internally, the model applies a set of coefficients from the Sandia Modules [library](#) to the simulation equations.
3. Choose a module structure from the three available options (displayed as front material / cell / back material). See [Temperature Correction](#) for details. Module manufacturers typically include a description of the front material, and frame or back material in a mechanical characteristics section of module specification sheets.

**Note.** The current version of the Sandia database contains a single low concentration photovoltaic module, listed as Entech 22X Concentrator [1994].

## Module Characteristics at Reference Conditions

SAM displays the module characteristics so that you can compare modules in the database to manufacturer specifications or to different modules in the database. These are nominal ratings. SAM calculates the operating values of these parameters during a simulation and displays them in the [Results](#).

### Reference conditions

The reference conditions describe the incident solar radiation, air mass, ambient temperature, and wind speed that apply to the module characteristics. The module efficiency, power, current, voltage, and temperature coefficients values are those for the module operating at the reference conditions.

### Nominal efficiency (%)

The module's rated efficiency at reference conditions. SAM displays this value for reference only. During a simulation, the model calculates an efficiency value for each time step, which you can see in the time series output data on the [Data tables](#) tab on the [Results page](#).

### Maximum power (Pmp), Wdc

The module rated power in DC Watts. Equal to the product of the maximum power voltage and maximum power current.

### Max power voltage (Vmp), Vdc

Maximum power voltage in DC Volts under reference conditions.

### Max power current (Imp), Adc

Maximum power current in DC Amps under reference conditions. Defines the maximum power point on the module's I-V curve.

### Open circuit voltage (Voc), Vdc

Open circuit voltage under reference conditions. Defines the open circuit point on the module's I-V curve.

### Short circuit current (Isc), Adc

Short circuit current under reference conditions. Defines the short circuit point on the module's I-V curve.

### Temperature coefficients

SAM displays the temperature coefficients in %/°C and W/°C at the different points on the power curve.

### Module structure and mounting

This option determines the coefficients that SAM uses to calculate the cell temperature in each hour of the simulation. The default option is **Use Database Values**, which displays the coefficients from the measured data at reference conditions. See [Temperature Correction](#) for details.

## Physical Characteristics

### Material

A description of the semiconductor technology used in the photovoltaic cells.

2-a-Si: dual-junction amorphous silicon

3-a-Si: triple-junction amorphous silicon

CdTe: cadmium telluride

CIS: copper indium diselenide

HIT-Si: amorphous silicon heterojunction

c-Si: single-crystal silicon

mc-Si: multi-crystalline silicon

### Vintage

The year that module coefficients were added to the database.

The letter "E" indicates that the coefficients were estimated from a combination of published manufacturer specifications and data from the outdoor testing of a similar module. Entries without an "E" are for modules whose coefficients were derived entirely from outdoor tests involving one more or more modules of that type.

Because the tested modules (listed without an "E") may have had different average power ratings than production versions of the same module, the database typically also includes an "E" entry for each of the tested modules that represents the average power rating specified by the manufacturer.

### Module area, m<sup>2</sup>

The total area of the module, including spaces between cells and the frame.

### Number of cells

Total number of cells in the module, equal to the product of the number of cells in series and number of cell strings in parallel.

### Number of cells in series

Number of cells connected in series per cell string.

### Number of cell strings in parallel

Number of cell strings connected in parallel per module.

## Sandia Temperature Correction

The Sandia temperature correction algorithm calculates a temperature correction factor that accounts for efficiency losses due to heating of the module during the day when the sun is shining. The algorithm calculates an hourly module temperature as a function of the solar radiation, ambient temperature, and wind speed in a given hour, and a set of properties describing the thermal characteristics of the cell and module.

For more details about the algorithm, see King et al, 2004. *Photovoltaic Array Performance Model*. Sandia National Laboratories. SAND2004-3535. <http://prod.sandia.gov/techlib/access-control.cgi/2004/043535.pdf>

**Note.** The SAM temperature correction algorithms do not account for cooling strategies used in some innovative photovoltaic systems.

## Guidelines for choosing the Module Structure - Mounting (a, b, dT) parameters

The *a*, *b*, and *dT* parameters determine the relationship between ambient temperature and module temperature. See the [equations](#) below for details.

SAM allows you to choose from a set of pre-determined values of the parameters for different module mounting options, or specify your own values for the parameters. For the Concentrating PV model, you can assign a set values to the parameters, or specify your own.

- For most analyses involving flat-plate modules mounted on open racks, choose **Use Database Values**. These are the values determined empirically during testing of the module. Most of the modules in the database were tested on open racks.



- To see how a flat-plate module might perform under different mounting conditions, choose an appropriate option from the list. Be sure to choose an option that is consistent with the module you are modeling. You may need to refer to the module's specification sheet for information about its structure.
- For the Concentrating PV model, use the default values (click **Default Temperature Inputs**) unless you have a set of  $a$ ,  $b$ , and  $dT$  values for your module. See the [equations](#) below for details.
- If you understand the Sandia model well enough to generate your own temperature correction coefficients, choose **User Defined**, and type your own values for  $a$ ,  $b$ , and  $dT$ . See the [equations](#) below for details.

**Table 1. Description of the module structure and mounting options.**

Module Structure and Mounting	Description
Glass/Cell/Polymer Sheet Open Rack	Solar cells are between a glass front and polymer back, and the module is mounted on an open rack allowing air to circulate freely around the module.
Glass/Cell/Glass Open Rack	Solar cells are between a glass front and glass back, and the module is mounted on an open rack allowing air to circulate freely around the module.
Polymer/Thin Film/Steel Open Rack	Solar cells are between a transparent polymer front and steel back, and the module is mounted on an open rack allowing air to circulate freely around the module.
Glass/Cell/Polymer Sheet Insulated Back	Solar cells are between a glass front and polymer back, and the module is mounted directly to a building surface in a building-integrated PV (BIPV) application preventing air from flowing over the module back.
Glass/Cell/Glass Close Roof Mount	Solar cells are between a glass front and glass back, and the module is mounted on a rack with little clearance between the building surface and module back allowing little air to flow over the module back.

### Transient Thermal Model Correction

When the simulation time step determined by the number of records in the weather file is 20 minutes or less, SAM automatically applies a correction to account for temperature changes driven by wind speed and the mass of the module using the method described in Prilliman (2020) listed on the [PV Publications](#) page of the SAM website..

#### Module unit mass, kg/m<sup>2</sup>

The mass of the module in kilograms per square meter of module area. The default value is 11 kg/m<sup>2</sup>.

### Sandia Temperature Correction Method

SAM uses the Sandia temperature correction method to calculate a module and cell temperature and temperature correction factor for the Sandia, [simple efficiency](#) and [high concentration photovoltaic \(HCPV\)](#) models. The model uses the temperature correction factor to adjust each hour's module efficiency value: The higher the module's temperature in a given hour, the lower the module's efficiency in that hour.

You can explore temperature effects on the array's performance in the time series output data. The data shows the hourly cell temperature, along with the solar radiation, wind speed, and ambient temperature.

The temperature correction equations use the following input values from the Module page:

- Temperature coefficients. The Sandia model uses the four values listed in the Temperature Coefficients column. The Simple Efficiency and Concentrating PV models use the single temperature coefficient of power value.
- Temperature correction coefficients:  $a$ ,  $b$ , and  $dT$ . For the Sandia and Simple Efficiency models, the three values appear under the Module Structure - Mounting option. For the Concentrating PV model, the values appear below the temperature coefficient variable.

The equations use four hourly data sets from the weather file. You can see the hourly data by either viewing the weather data from the [Location and Resource](#) page, or viewing the time series results data after running a simulation:

- Incident direct normal radiation
- Incident diffuse radiation
- Ambient temperature
- Wind speed

**Table 2. Empirically-determined coefficients from the Sandia database for each of the module structure and mounting options available on the Module page.**

Module Structure and Mounting	a	b	dT °C
Glass/Cell/Polymer Sheet Open Rack	-3.56	-0.0750	3
Glass/Cell/Glass Open Rack	-3.47	-0.0594	3
Polymer/Thin Film/Steel Open Rack	-3.58	-0.113	3
Glass/Cell/Polymer Sheet Insulated Back	-2.81	-0.0455	0
Glass/Cell/Glass Close Roof Mount	-2.98	-0.0471	1
Concentrating PV Module	-3.2	-0.09	17
User Defined	-99	0	0

**Note.** The default values for the User Defined option effectively remove temperature correction from the model so that the cell temperature is equal to the ambient temperature.

**Table 3. Sample temperature coefficient values for different cell types based on an informal survey of manufacturer module specifications.**

Cell Type	Maximum Power Temperature Coefficient (%/°C)
Monocrystalline Silicon	-0.49
Polycrystalline Silicon	-0.49
Amorphous Silicon	-0.24
Amorphous Silicon Triple Junction	-0.21
Copper Indium Gallium DiSelenide (CIGS)	-0.45
Cadmium Telluride (CdTe)	-0.25

### Sandia Temperature Correction Equations

The temperature correction algorithm first calculates the module back temperature based on the incident solar radiation,  $a$  and  $b$  coefficients, and the ambient temperature and wind speed:

$$T_{\text{Back}} = E_{\text{Incident}} \cdot e^{a+b \cdot v_{\text{Wind}}} + T_{\text{Ambient}}$$

**Note.** SAM assumes that the ambient temperature and wind speed data in the weather file are mid-hour values and that the radiation values are end-of-hour values. SAM interpolates temperature and wind speed values by averaging the current hour value with the previous hour value.

Next, the cell temperature is calculated based on the module back temperature, incident radiation, and  $dT$ :

$$T_{\text{Cell}} = T_{\text{Back}} + \frac{E_{\text{Incident}}}{E_0} \cdot dT$$

The temperature correction factor  $F_{\text{TempCorr}}$  is:

$$F_{\text{TempCorr}} = 1 + \gamma \cdot (T_{\text{Cell}} - T_{\text{Ref}})$$

In general, the temperature corrected module power is the product of the power calculated by the module model and the temperature correction factor. Each module model (Sandia, Simple Efficiency, Concentrating PV) uses a different algorithm to calculate the module power before temperature correction:

$$P_{\text{TempCorr}} = P_{\text{BeforeTempCorr}} \cdot F_{\text{TempCorr}}$$

Where,

$E_{\text{Incident}}$ (W/m <sup>2</sup> )	The sum of the direct normal and diffuse radiation for the current hour in the weather data. SAM determines this value based on the data in the weather file.
$E_0$ (W/m <sup>2</sup> )	The reference total incident radiation, equal to 1000 W/m <sup>2</sup> .
$T_{\text{ref}}$ (°C)	The reference temperature in degrees Celsius, equal to 25°C.
$\gamma$ (%/°C)	The maximum power temperature coefficient from Module page.

$a, b$	Values from the Module page. They are empirically-determined coefficients accounting for the effect of wind on the module temperature: $a$ defines the module temperature upper limit (at low wind speed and high solar radiation levels), and $b$ defines the rate at which module temperature decreases as wind speed increases. The values depend on the module's construction, which determines its ability to absorb and shed heat. See the table above for typical values.
$dT$	Value from the Module page. The temperature difference between the cell and module back surface at the reference incident radiation of 1000 W/m <sup>2</sup> . The value depends on how the module is mounted in the system, which determines how much air comes into contact with the module back surface. See the table above for typical values.
$v_{Wind}$ (m/s)	Wind speed from the weather file in meters per second.
$T_{Ambient}$ (°C)	Ambient temperature from weather file.
$F_{TempCorr}$	Temperature correction factor
$P_{BeforeTempCorr}$	Module power before temperature correction
$P_{TempCorr}$	Temperature-corrected module power

## Simple Efficiency Module Model

The flat-plate photovoltaic simple efficiency module model calculates the module's hourly DC output assuming that the module efficiency varies with radiation incident on the module as defined by the radiation level and efficiency table. The model makes an adjustment for cell temperature using the [Sandia temperature correction algorithm](#).

### **To use the simple efficiency module model:**

1. On the Module page, choose **Simple Efficiency Module Model**.
2. Enter a temperature coefficient. This is the number typically reported on manufacturer specification sheets as the maximum power coefficient. See [Sandia Temperature Correction](#) for suggested values.
3. Enter the module's total cell area in square meters, equivalent to the product of the cell area and number of cells.
4. Type values for the module's maximum power and open circuit voltages. SAM uses these values for array sizing on the [System Design](#) page.
5. Choose a module structure from the three available options (displayed as front material / cell / back material). See [Sandia Temperature Correction](#) for details.  
Module manufacturers typically include a description of the front material, and frame or back material in a mechanical characteristics section of module specification sheets.
6. In the Radiation Level and Efficiency Table, enter an efficiency value for each of the five incident global radiation reference values in increasing order. If you are defining the efficiency curve with fewer than five efficiency values, *you must include five radiation values*, but you can assign the same efficiency value to more than one radiation value. For example, to represent a module with 13.5% constant efficiency, you would assign the value 13.5 to each of the five radiation values 200, 400, 600, 850, 1000.

7. Choose the radiation level that represents the reference value, often  $1000 \text{ W/m}^2$  for flat-plate modules.  
SAM uses the reference value to calculate the module's rated power, displayed as the Power variable on the Module page.

## Characteristics

The module characteristics define the module's capacity, efficiency, and thermal characteristics.

### Maximum power (Pmp), Wdc

The module's rated maximum DC power at the reference radiation indicated in the radiation level and efficiency table. SAM uses this value to calculate the array cost on the PV System Costs page, but not in simulation calculations. The module power is the product of the reference radiation, reference efficiency, and area.

### Temperature coefficient (Pmp), %/C

The rated maximum-power temperature coefficient as specified in the module's technical specifications. See [Sandia Temperature Correction](#) for details.

### Area, m<sup>2</sup>

The module collector area in square meters. To calculate the area for a given module power rating at a given reference radiation level, divide the power rating by the module efficiency and radiation level. For example, a module with a 100 W rating and 13.5% efficiency at  $1000 \text{ W/m}^2$  would require an area of  $100 \text{ W} / (0.135 \times 1000 \text{ W/m}^2) = 0.74074 \text{ m}^2$ .

### Maximum power voltage (Vmp)

The voltage at the module's maximum power point.

### Open circuit voltage (Voc)

The module's open circuit voltage.

### Module structure and mounting

The module's front and back materials (front material/cell/back material) used in the [Sandia temperature correction algorithm](#).

## Bifacial Specifications

SAM's bifacial model is adapted from Marion, B, et. al (2017) A Practical Irradiance Model for Bifacial PV Modules, available for download from the [SAM website](#). The model's open source implementation is available on the NREL GitHub website at <https://github.com/NREL/bifacialv6>. The bifacial model calculates the plane-of-array irradiance on the rear side of the PV modules in the array assuming infinite rows. The rear-side plane-of-array irradiance is multiplied by the module bifaciality factor, and then added to the front-side plane-of-array irradiance, which is then sent to the module model to predict module DC power. Primary drivers of the rear-side POA irradiance include the ground albedo, row-to-row spacing (function of ground-coverage ratio), and ground clearance height.

### Module is bifacial

Check this box to enable the bifacial model and its inputs.

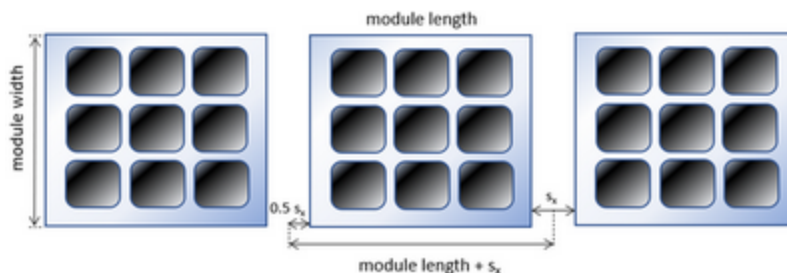
**Note.** The CEC module library indicates whether the module is bifacial. You can sort the library table by clicking the Bifacial column heading: Bifacial modules have a value of one.

### Transmission Fraction

The ratio of array area that prevents light from reaching the surface behind the array to the area that lets light through as a fraction between 0 and 1. For modules made of glass or other transparent material that allows light to pass through the module between cells, the ratio would be the total cell area divided by the total array area. For modules with an opaque back, the ratio would be the total module area divided by the total array area.

For example, given the diagram below of a rectangular array of modules that allow light to pass both in the space between cells and the space between modules, the transmission factor would be:

$$\text{Transmission Factor} = \text{Total Cell Area (m}^2\text{)} / [ (\text{Module Length (m)} + S_x \text{ (m)}) \times \text{Module Width (m)} ]$$



**Note.** The module dimensions you use for this calculation should be consistent with any dimensions you use elsewhere in SAM, such as for shading calculations.

### Bifaciality

The ratio of rear-side efficiency to front-side efficiency. Typically a value between 0.65 and 0.9 provided on the bifacial module datasheet.

### Ground clearance height

The height from the ground to the bottom of the PV array. For systems with tracking, this is the height at a zero-degree tilt angle.

## Radiation Level and Efficiency Table

### Irradiance (W/m<sup>2</sup>)

The plane-of-array total (beam and diffuse) irradiance level at which the given efficiency value applies.

### Efficiency (%)

The module conversion efficiency at a given incident global radiation level. SAM calculates an efficiency value for each hour in the simulation using linear extrapolation to determine the value based on radiation data from the weather file. The efficiency values represent the efficiency of conversion from incident global radiation to DC electrical output.

### Reference Condition

Indicates the value to use to calculate the nominal maximum power value.

### Diffuse utilization factor

This advanced input allows you to adjust the diffuse component of the radiation incident on the module. For most applications, you should use the default value of 1. For modules that do not use all of the diffuse radiation, such as low-x concentrator, you can use a value less than one.

During a simulation, the single-point efficiency model calculates the module DC output reported in the [Results](#) as the product of the total incident global radiation, module area, and temperature correction factor:

$$P_{mp,Module} = E_{TotalIncident} \cdot A_{Module} \cdot \eta_{Module} \cdot F_{TempCorr}$$

Where,

$E_{TotalIncident}$ (W/m <sup>2</sup> )	Total incident radiation from the weather data processor.
$A_{Module}$ (m <sup>2</sup> )	The module area in square meters.
$\eta_{Module}$	Module efficiency at a given incident global radiation level, calculated by extrapolating values from the Radiation Level and Efficiency Table.
$F_{TempCorr}$	Temperature correction factor. See <a href="#">Sandia Temperature Correction</a> for details.

## CEC Performance Model with User Entered Specifications

The CEC Performance Model with User Entered Specifications allows you to run the CEC module model with module specifications from a module manufacturer's data sheet.

When you use the model, you first enter a set of specifications to generate a set of coefficients for the module on the [Module](#) page, and then run a simulation of the PV system after specifying the rest of the system on the [System Design](#), [Inverter](#), and other input pages.

SAM uses the module specifications you provide to calculate a set of parameters at reference conditions for the CEC module model. During a simulation, the model adjusts temperature and incident irradiance coefficients to calculate the module efficiency at operating conditions other than STC. Note that the model does not account for all non-linear effects in the relationship of module power and irradiance.

The calculations involve a combination of empirical regressions and heuristic methods to automatically solve a multidimensional set of non-linear equations. An error checking algorithm ensures that the model can find solutions for most modules.

### **Notes.**

SAM stores the calculated parameters with the case in your .sam file. It does not store them in a library that you can use in other files or cases. To use a module in a different file or case, use the Save / Load Data buttons to save the parameters to a text file that you can use to load into another file or case.

If you use specifications from a manufacturer's data sheet for a module that exists in the CEC Performance Model with Module Database, SAM may calculate a different set of parameters than those in the CEC library. That is because the specifications used to generate parameters in the CEC library are based on specifications provided by third party testing facilities, which may differ from data on the manufacturer data sheet.

### **To use the CEC Performance Model with User Entered Specifications:**

1. On the Module page, choose **CEC Performance Model with User Entered Specifications**.
2. Enter the required module specifications.  
**Module description** is an optional field you can use for the module name or other description.
3. Click **Calculate and plot**.  
After solving the module model equations, SAM displays a current-voltage (I-V) curve at STC.

**Note.** In some rare cases, SAM may not be able to find a solution for the set of specifications you provide. (It performs a series of internal checks that should ensure that it finds a solution in most cases.) If SAM displays an error message, first verify that the specifications you entered are correct. If the specifications are correct, you may be able to generate an I-V curve by making small adjustments to the specifications, such as slightly increasing the Isc value.

4. Under **Mounting Configuration**, choose the standoff height and array's height above ground.

## General Information

### Module description

An optional string describing the module.

### Cell type

A description of the semiconductor technology used in the photovoltaic cells. This parameter is used to guide the solution of normalized module coefficients, but is not directly used for power calculations once the coefficients are determined.

monoSi: Single-crystal silicon

multiSi: Multi-crystalline silicon

CdTe: Cadmium telluride

CIS: Copper indium diselenide

CIGS: Copper indium gallium sulfide

amorphous: Amorphous silicon

### Module area, m<sup>2</sup>

The surface area of the entire module.

### Nominal operating cell temperature, °C

The nominal operating cell temperature (NOCT) of the module is the measured cell temperature of the module at NOCT test conditions: 800 W/m<sup>2</sup> incident irradiance, 20 degrees Celsius ambient temperature, and 1 m/s wind speed. The mounting configuration under test conditions is typically open rack, except building-integrated (BIPV) modules which are tested in a building-integrated configuration.

## Electrical Specifications

### Maximum power point voltage (Vmp), V

The reference maximum power point voltage at STC.

### Maximum power point current (Imp), A

The reference maximum power point current at STC.

### Open circuit voltage (Voc), V

The open circuit voltage at STC.

### Short circuit current (Isc), A

The short circuit current at STC.



**Temperature dependence of Voc, V/°C or %/°C**

The absolute change in Voc per degree change in temperature, also called alpha.

**Temperature dependence of Isc, A/°C or %/°C**

The absolute change in Isc per degree change in temperature, also called beta.

**Temperature dependence of Pmp, %/°C**

The percentage change in the maximum power point Pmp per degree change in temperature, also called gamma. To convert units from W/°C to %/°C, divide the %/°C value by Pmp.

**Number of cells in series**

The number of cells wired together in series inside the module.

**Bifacial Specifications**

SAM's bifacial model is adapted from Marion, B, et. al (2017) A Practical Irradiance Model for Bifacial PV Modules, available for download from the [SAM website](#). The model's open source implementation is available on the NREL GitHub website at <https://github.com/NREL/bifacialv>. The bifacial model calculates the plane-of-array irradiance on the rear side of the PV modules in the array assuming infinite rows. The rear-side plane-of-array irradiance is multiplied by the module bifaciality factor, and then added to the front-side plane-of-array irradiance, which is then sent to the module model to predict module DC power. Primary drivers of the rear-side POA irradiance include the ground albedo, row-to-row spacing (function of ground-coverage ratio), and ground clearance height.

**Module is bifacial**

Check this box to enable the bifacial model and its inputs.

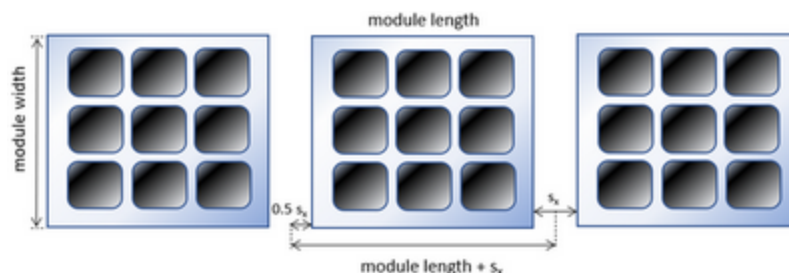
**Note.** The CEC module library indicates whether the module is bifacial. You can sort the library table by clicking the Bifacial column heading: Bifacial modules have a value of one.

**Transmission Fraction**

The ratio of array area that prevents light from reaching the surface behind the array to the area that lets light through as a fraction between 0 and 1. For modules made of glass or other transparent material that allows light to pass through the module between cells, the ratio would be the total cell area divided by the total array area. For modules with an opaque back, the ratio would be the total module area divided by the total array area.

For example, given the diagram below of a rectangular array of modules that allow light to pass both in the space between cells and the space between modules, the transmission factor would be:

$$\text{Transmission Factor} = \text{Total Cell Area (m}^2\text{)} / [ (\text{Module Length (m)} + S_x \text{ (m)}) \times \text{Module Width (m)} ]$$



**Note.** The module dimensions you use for this calculation should be consistent with any dimensions you use elsewhere in SAM, such as for shading calculations.

### **Bifaciality**

The ratio of rear-side efficiency to front-side efficiency. Typically a value between 0.65 and 0.9 provided on the bifacial module datasheet.

### **Ground clearance height**

The height from the ground to the bottom of the PV array. For systems with tracking, this is the height at a zero-degree tilt angle.

## **Mounting Configuration**

SAM's CEC Performance Model with User Entered Specifications uses the [NOCT Cell Temperature model](#) from the CEC Performance Model with Module Database model.

### **Standoff height**

The standoff height is the distance between the back of the module and surface of the roof for roof-mounted modules. For modules integrated with the building (BIPV), or for ground mounted modules, choose the appropriate option.

**Note.** SAM does not make NOCT adjustments for the **Building integrated, Greater than 3.5 in, or Ground or rack mounted** options. For these options, the **Nominal operating cell temperature** value you provide should be at conditions appropriate for those types of installations.

### **Approximate installation height**

SAM uses the installation height option to make an adjustment to the effect of wind speed on the cell temperature calculation. SAM assumes that an array with an installation height of one story or lower experiences lower wind speeds than those in the weather file because of the effect of nearby trees and structures. For the two story building or higher option, the wind is less impeded.

## **Nominal Maximum Power Ratings at STC**

### **Power, Wdc**

The module's rated maximum power point power at STC. This is equal to the product of the maximum power point voltage and maximum power point current.

### **Efficiency, %**

The module's rated efficiency at STC 1000 W/m<sup>2</sup> irradiance. SAM displays this value for reference only. During a simulation, the model calculates an efficiency value for each hour, which you can see in the [Tables](#) on the [Results](#) page.

## **Transient Thermal Model Correction**

When the simulation time step determined by the number of records in the weather file is 20 minutes or less, SAM automatically applies a correction to account for temperature changes driven by wind speed and the mass of the module using the method described in Prilliman (2020) listed on the [PV Publications](#) page of the SAM website.

### **Module unit mass, kg/m<sup>2</sup>**

The mass of the module in kilograms per square meter of module area. The default value is 11 kg/m<sup>2</sup>.

## IEC 68153 Single Diode Model

The IEC-61853 Single Diode model is a detailed method for predicting the performance of flat plate photovoltaic modules. The model uses data from modules tested according to the International Electrotechnical Commission (IEC) power and rating standard, [IEC 61853](#), *Irradiance and Temperature Performance Measurements and Power Rating*. The standard describes requirements for testing PV module performance at maximum power operation for a set of 23 operational conditions, denoted by a \* in the table below.

Irradiance (W/m <sup>2</sup> )	Tmodule = 15 °C	Tmodule= 25 °C	Tmodule = 50 °C	Tmodule = 75 °C
1100	N/A	*	*	*
1000	*	*	*	*
800	*	*	*	*
600	*	*	*	*
400	*	*	*	N/A
200	*	*	*	N/A
100	*	*	N/A	N/A

At each test condition, the module's Pmp, Vmp, Voc, and Isc are measured. SAM uses this data to calibrate parameters for an extended single diode model that is used to predict the module's performance at any operating condition. The details of the underlying model and parameter extraction method are detailed in Dobos, A.; MacAlpine, S. (2014). [Procedure for Applying IEC-61853 Test Data to a Single Diode Model](#). Proc. IEEE 40th PVSC Conf. Denver CO.

In addition to the test data, the module area (m<sup>2</sup>), nominal operating cell temperature (NOCT) (C), number of cells in series, and cell type are required inputs.

Thermal and optical behavior of the module is predicted using the CEC NOCT cell temperature model described in De Soto, W.L. (M.S. 2004). "Improvement and Validation of a Model for Photovoltaic Array Performance." University of Wisconsin-Madison. ([ZIP 1.8 MB](#)).

The module cover uses the PVWatts Version 5 model to predict the relative performance of standard glass versus antireflective coatings described in Dobos, A. (2014). "PVWatts Version 5 Manual." 20 pp.; NREL Report No. TP-6A20-62641. ([PDF 714 KB](#)).

The spectral response is governed by the Sandia model polynomial for air mass described in King, D.L.; Gonzalez, S.; Galbraith, G.M.; and Boyson, W.E. (2007). "Performance Model for Grid Connected Inverters." 47 pp.; Sandia Report No. 2007-5036. ([PDF 1.3 MB](#)).

### To use the IEC 68153 Single Diode model:

1. Obtain test data for your PV module from a testing laboratory or a manufacturer. SAM does not include a library of test result parameters for this model.
2. Enter the data into SAM's input table. The table structure is a little different from the matrix above. Each row in SAM's table corresponds to a test condition. The columns are: irradiance (W/m<sup>2</sup>), module temperature (C), maximum power (W), maximum power voltage (V), open circuit voltage (V), and short circuit current (A).

**Note.** Some test labs are not able to test up to 75 degrees, as defined by the standard, and may provide measurements only at 60 or 65 degrees. In other cases, some test conditions may be missing. In this situation, enter all of the data that you have available, and SAM will do its best to extract model parameters. Data at standard test conditions (1000 W/m<sup>2</sup>, 25 C) is always required.

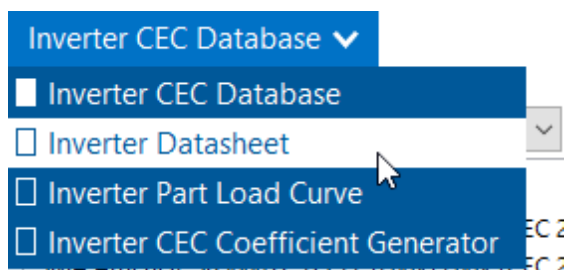
3. Enter the number of cells in series, and select a cell type. The module area and NOCT cell temperature are also required.
4. Click **Calculate parameters**.  
SAM displays a message details about how it determines the STC, Rsh, Rs, and temperature coefficient parameters for the model.
5. If the parameter estimation was successful, click **OK** and the model parameter inputs will be filled in automatically, along with the I-V curves on the graph.
6. Choose a mounting configuration, including a standoff height and an approximate mounting height.
7. Choose the type of module cover: standard glass, or anti-reflective coating (AR) glass.
8. If you have data available, you can change the spectral response by adjusting the air mass modifier polynomial coefficients.

## 8.6.2 Inverter

The Inverter page allows you to choose an inverter performance model and either choose an inverter from a list, or enter inverter parameters from a manufacturer's data sheet using either a weighted efficiency or a table of part-load efficiency values.

SAM can only model a photovoltaic system with a single type of inverter. Specify the number of inverters in the system on the [System Design](#) page.

SAM displays the name of the active inverter model at the top of the Inverter page. Click the model name to choose a different model:



You can choose from three different inverter performance models:

- [Inverter CEC Database](#) calculates the system's AC output using parameters from SAM's CEC database of inverter parameters with the Sandia inverter model. To use this model, you simply choose an inverter from the list. Use this model for most analyses.
- [Inverter Datasheet](#) allows you to specify the inverter's parameters using values from a manufacturer's data sheet, and calculates coefficients for the Sandia inverter model from the parameters you provide. Use this model for an inverter that is not in the CEC database.

- [Inverter Part Load Curve](#) allows you to specify a table of part-load efficiency values for an inverter using data from a manufacturer's data sheet or other source. Use this model when you have the inverter's part-load efficiency data.
- [Inverter CEC Coefficient Generator](#) generates coefficients for the Sandia inverter model when you have inverter test data.

Each of the three inverter models calculates a DC to AC conversion efficiency, assuming that the DC power input to the inverter is equal to the DC output of the photovoltaic array. SAM uses the inverter operating ranges parameters to either [size the system](#) or display sizing suggestion messages on the [System Design](#) page.

The inverter model reports several hourly simulation results on the [Results](#) page that you can use to understand how SAM models the inverter or to troubleshoot your analyses:

For a complete technical description of SAM's photovoltaic model, see Gilman, P.; Dobos, A.; DiOrio, N.; Freeman, J.; Janzou, S.; Ryberg, D. (2018) SAM Photovoltaic Model Technical Reference Update. 93 pp.; NREL/TP-6A20-67399 available along with other technical documentation from the [SAM website](#).

## Inverter Clipping Loss

SAM models two types of inverter clipping loss.

- Power limiting losses occur in time steps when the inverter's AC power output exceeds the total inverter nameplate AC capacity. During those time steps, SAM adjusts the inverter output to the inverter nameplate capacity (it does not adjust the inverter's input voltage).
- MPPT voltage limit losses occur in time steps when the Array's DC voltage falls outside the rated inverter minimum and maximum MPPT limits. In those time steps, SAM adjusts the array DC voltage to the inverter's maximum or minimum MPPT voltage limit as appropriate.

You can see inverter clipping losses in the [results](#) and in the [loss diagram](#).

### Notes.

SAM cannot model MPPT voltage limit losses with the Sandia or Simple Efficiency [module](#) models because those models assume that the module operates at its maximum power point, and do not allow the module's operating voltage to be changed from the maximum power point.

You can run the **System Sizing** [macro](#) to generate a detailed report about clipping losses and the inverter's MPPT performance.

## Inverter Temperature Derate Curves

SAM adjusts the inverter efficiency based on the ambient temperature in the weather file based on the Efficiency - Ambient Temperature curve under **Inverter Temperature Derate Curves**. The default curve decreases the inverter efficiency as the ambient temperature increases above 52.8 degrees Celsius at a rate of 0.021% per degree of temperature increases. You can edit the values in the efficiency table to change the shape of the curve.

## Inverter CEC Database

The Inverter CEC Database model is an implementation of the Sandia Model for Grid-Connected PV Inverters (Sandia inverter model). It is an empirically-based performance model of inverter performance that uses

parameters from a database of commercially available inverters maintained by the California Energy Commission (CEC).

The Inverter CEC Database model consists of a set of equations that SAM uses to calculate the inverter's hourly AC output based on the DC input (equivalent to the electrical output of the photovoltaic array) and a set of empirically-determined coefficients that describe the inverter's performance characteristics. The coefficients for each inverter are empirically determined from data provided by the inverter's manufacturer and either field measurements from an inverter of the same type installed in an operating photovoltaic system, or laboratory measurements. Measured values are taken using the CEC inverter test protocol.

The Sandia inverter model is described in the following documents:

- King D et al (2007) Performance Model for Grid-Connected Photovoltaic Inverters, Sandia National Laboratories, SAND2007-5036 ([PDF 1.3 MB](#))
- On the [PV Performance Modeling Collaborative website](#)
- Gilman, P. et al (2018). SAM Photovoltaic Model Technical Reference. National Renewable Energy Laboratory Update. 59 pp.; NREL/TP-6A20-67399. (Available on the [SAM website](#).)

The CEC inverter test protocol is described in:

- Bower W et al (Draft 2004) Performance Test Protocol for Evaluating Inverters Used in Grid-Connected Photovoltaic Systems ([PDF 584 KB](#))
- [PV Performance Modeling Collaborative website](#)

#### Notes.

The inverter library stores data from the [California Energy Commission solar equipment lists](#), as of the date of the SAM software release.

If you represent an inverter manufacturer and would like to add equipment to the list, you should contact the California Energy Commission (CEC) at the link above.

To model an inverter that is not in the database, use the [Inverter Datasheet](#) model.

If you have inverter test data, you can use the [Inverter CEC Coefficient Generator](#) model.

#### **To use the Inverter CEC Database model:**

1. On the Inverter page, choose **Inverter CEC Database**.
2. Choose an inverter from the list of available inverters. You can type a few letters of the manufacturer or inverter name in the Search box to filter the list.

If you are modeling an inverter not included in the database and want to use the Sandia inverter model, you can use the [Inverter Datasheet](#) model with values from a manufacturer's data sheet.

Each inverter listing shows the manufacturer name, model number and AC voltage rating, and information in brackets about the organization responsible for generating the test data and the year the data was generated. "CEC" indicates that test data was generated by the California Energy Commission.

### **Efficiency Curve and Characteristics**

When you select an inverter from the list, SAM displays an efficiency curve and the inverter's parameters for your reference. The parameter values are from the Sandia inverter library, and are values that the Sandia inverter model uses as inputs.

**Note.** SAM displays a few of the parameters from the CEC database on the Inverter page. If you want to see the complete set of parameters, you can do so in the [library editor](#).

### Number of MPPT inputs

The number of maximum power point tracking (MPPT) inputs in the system. In the actual system, the MPPT hardware may be integrated with the inverter, or separate devices.

In order to model the operating voltage of each input separately, you should assign each MPPT input to a separate subarray on the [System Design](#) page.

### CEC weighted efficiency and European weighted efficiency, %

SAM calculates and displays both the CEC weighted efficiency and European weighted efficiency for your reference. It does not use these efficiency values during a simulation. To calculate the efficiencies, SAM calculates the inverter's nominal efficiency at seven different power levels, and applies the set of weighting factors for the CEC and European methods of calculating the [weighted efficiency](#).

The following list briefly describes the each parameter that SAM displays on the Inverter page. You can read more about these and all of the other Sandia inverter model input parameters in the King 2004 reference cited above. The names in brackets are the names used in the King reference.

### Maximum AC power [Power ACo], Wac

Maximum output AC power at reference or nominal operating conditions. Available from manufacturer specifications.

### Maximum DC power [Power DCo], Wdc

Input DC power level at which the inverter's output is equal to the maximum AC power level. Available from manufacturer specifications.

### Power consumption during operation [PowerSo], Wdc

DC power required for the inverter to start converting DC electricity to AC. Also called the inverter's self-consumption power. Sometimes available from manufacturer specifications, and not to be confused with the nighttime AC power consumption.

### Power consumption at night [PowerNTare], Wac

AC power consumed by the inverter at night to operate voltage sensing circuitry when the photovoltaic array is not generating power. Available from manufacturer specifications.

### Nominal AC voltage [AC Voltage], Vac

Rated output AC voltage from manufacturer specifications.

### Maximum DC voltage [Vdcmax], Vdc

The inverter's maximum DC input voltage rating.

This value does not affect simulation results. See the note below for details.

### Maximum DC current [Idcmax], Adc

The maximum DC voltage input, typically at or near the photovoltaic array's maximum power point current.

### Minimum MPPT DC voltage [MPPT-low], Vdc

Manufacturer-specified minimum DC operating voltage.

**Nominal DC voltage [Vdco], Vdc**

The nominal, or design input voltage.

**Maximum MPPT DC voltage [MPPT-hi], Vdc**

Manufacturer-specified maximum DC operating voltage. The test protocol referenced above specifies that the inverter's maximum DC voltage should not exceed 80% of the array's maximum allowable open circuit voltage.

**Note.** During a simulation, SAM limits the inverter's DC operating voltage to the MPPT voltage ratings, so the operating voltage at an inverter MPPT input is never less than the inverter's MPPT minimum rating (MPPT-low) or greater than the MPPT maximum rating (MPPT-hi).

The maximum DC voltage (Vdcm<sub>ax</sub>) is often shown on manufacturer datasheets for string sizing calculations, but is not provided in the data from the California Energy Commission. SAM populates this input with the maximum MPPT DC Voltage value from the database, but the input is editable so you can change its value before running the System Sizing macro if you want to compare the operating open circuit voltage to this maximum voltage rating.

The four coefficients C0..C3 are empirically-determined coefficients that are inputs to the Sandia inverter model. Manufacturers do not provide these coefficients on inverter datasheets.

**C0, 1/V**

Defines the relationship between AC and DC power levels at the reference operating condition.

**C1, 1/V**

Defines the value of the maximum DC power level.

**C2, 1/V**

Defines the value of the self-consumption power level.

**C3, 1/V**

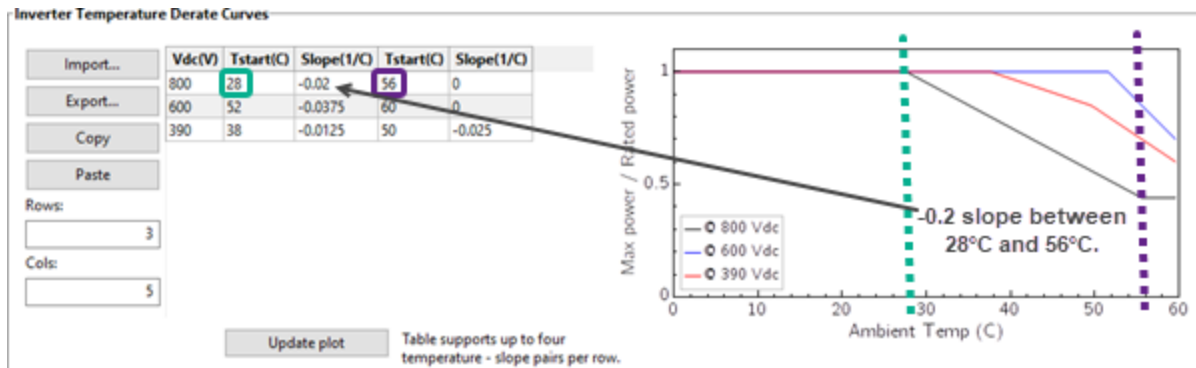
Defines the value of Coefficient C0.

**Inverter Temperature Derate Curves**

SAM uses the information in the inverter temperature derate curves with ambient temperature data from the weather file to adjust the inverter efficiency in each time step of the simulation. As ambient temperature increases, the inverter efficiency decreases based on the data in the table. Inverter efficiency decreases more rapidly with temperature increase at higher operating voltages.

If your inverter datasheet does not provide detailed temperature data, you can use the default data shown in this screenshot:





The temperature derate curve for each voltage level in the table is defined by a start temperature and slope. You can include up to four temperature-slope value pairs in the table. The default data has two temperature-slope pairs and three voltage levels.

### Vdc (V)

The operating temperature for the temperature derate curve. Assign one row for each voltage level. Change the value of **Rows** to add or remove rows.

### Tstart (C)

The temperature at which the slope applies. To add a temperature-slope pair, add two columns to the table. Change the value of **Cols** to add or remove rows. Acceptable values for the number of columns are 5, 7, and 9.

### Slope (1/C)

The slope of the curve beginning at the start temperature.

### Update plot

After change values in the table, click Update plot to change the graph.

## Inverter Datasheet

The Inverter Datasheet model is an implementation of the Sandia Model for Grid-Connected PV Inverters that allows you to model an inverter by entering data from a manufacturer's data sheet.

The Inverter Datasheet model consists of a set of equations that SAM uses to calculate the inverter's hourly AC output based on the DC input (equivalent to the electrical output of the photovoltaic array) and performance parameters from the inverter manufacturer's datasheet. The model works by setting the [C coefficients](#) of the Sandia inverter model to zero.

**Note.** If you have a table of part-load efficiency values for the inverter, you may want to use the [Inverter Part Load Curve model](#) instead of the Inverter Datasheet model. If you have CEC test data for the inverter, you can use the [Inverter Coefficient Generator](#).

### To use the Inverter Datasheet model:

On the Inverter page, click **Change**, and choose **Inverter Datasheet**.

- Enter input values from the manufacturer's data sheet. See below for descriptions of the inputs.

## Power Ratings

### Maximum AC output power

The inverter's rated maximum AC output in Watts. Manufacturers may use different names for this value, such as continuous output power, rated active power, peak output, etc.

### Weighted efficiency and Manufacturer efficiency

Inverter manufacturers provide different efficiency ratings on their product data sheets. SAM can model the inverter using either a weighted efficiency or a nominal efficiency. If the manufacturer provides a weighted efficiency, you should use it rather than the nominal efficiency. The weighted efficiency more accurately reflects the inverter's performance under different operating conditions.

If you choose **Weighted efficiency**, you can use the weighted efficiency calculated with either the European or CEC method. The European method is best for locations with lower solar resource where the inverter operates more often at lower load levels. The CEC method is best for sunnier locations where the inverter operates at higher load levels. See [Weighted Efficiency](#) for more details.

If you choose **Manufacturer efficiency**, you can use either a peak efficiency or another efficiency value from the data sheet that represents the inverter's efficiency at a single load level. You should also specify a value for **Power consumption during operation** to improve the accuracy of the model at low power levels.

### Maximum DC input power

SAM calculates and displays the equivalent rated DC input capacity based on the maximum AC output power and efficiency value that you specify (either weighted or nominal):

$$\text{Maximum DC Input Power (Wdc)} = \text{Maximum AC Output Power (Wac)} \div \text{Efficiency (\%)} \times 100\%$$

SAM uses the maximum DC input power value to size the array when you choose **Specify desired array size** on the [System Design](#) page, and to display sizing messages when you choose **Specify modules and inverters**.

## Operating Ranges

SAM uses the operating range variables to help you size the system on the [System Design](#) page.

### Nominal AC operating voltage

The inverter's nominal AC output voltage.

### Maximum DC voltage

The inverter's maximum input DC voltage.

### Maximum DC current

The inverter's maximum input DC current.

### Minimum MPPT DC voltage

The inverter's minimum DC operating voltage.

### Nominal DC voltage

The inverter's nominal DC operating voltage.

### Maximum MPPT DC voltage

The inverter's maximum DC operating voltage.

### Number of MPPT inputs

The number of maximum power point tracking (MPPT) inputs in the system. In the actual system, the MPPT hardware may be integrated with the inverter, or separate devices.

In order to model the operating voltage of each input separately, you should assign each MPPT input to a separate subarray on the [System Design](#) page.

### Losses

The two loss variables account for electricity consumed by inverter components during operation and to keep the inverter in standby mode at night when the array is not generating electricity.

When you specify the inverter's efficiency using a weighted efficiency, you only need to specify a value for the night-time power consumption because the weighting factors account for the power consumption during operation.

SAM displays a suggested value for each loss variable, which is based on an analysis of the loss parameters for the inverters in the SAM 2013.1.5 CEC library, and should be a reasonable approximation for inverters currently available on the market. If the manufacturer does not provide values for the inverter's power consumption, you can use the suggested value. (You must type the value in the input box, SAM does not automatically assign the suggested value to the variable.)

#### Power consumption during operation

Electricity consumed by the inverter during the day when the photovoltaic array is generating power. SAM disables this variable when you specify a weighted efficiency.

SAM calculates the suggested value using the following equation:

$$\text{Suggested Value for Consumption during Operation (Wdc)} = 0.8\% \times \text{Maximum AC Output Power (Wac)}$$

#### Power consumption at night

Electricity consumed by the inverter during the night when the photovoltaic array is not generating power. This value is sometimes also called tare loss or standby loss.

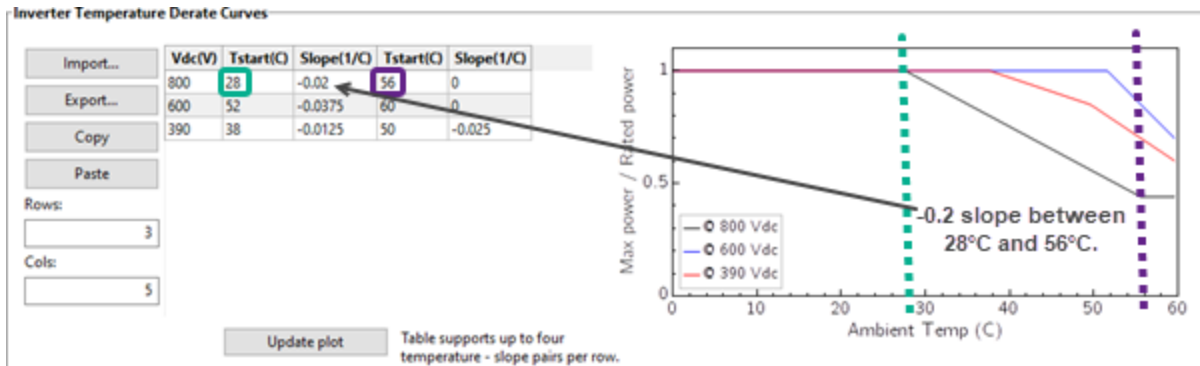
SAM calculates the suggested value using the following equation:

$$\text{Suggested Value for Consumption at Night (Wac)} = 0.025\% \times \text{Maximum AC Output Power (Wac)}$$

### Inverter Temperature Derate Curves

SAM uses the information in the inverter temperature derate curves with ambient temperature data from the weather file to adjust the inverter efficiency in each time step of the simulation. As ambient temperature increases, the inverter efficiency decreases based on the data in the table. Inverter efficiency decreases more rapidly with temperature increase at higher operating voltages.

If your inverter datasheet does not provide detailed temperature data, you can use the default data shown in this screenshot:



The temperature derate curve for each voltage level in the table is defined by a start temperature and slope. You can include up to four temperature-slope value pairs in the table. The default data has two temperature-slope pairs and three voltage levels.

**Vdc (V)**

The operating temperature for the temperature derate curve. Assign one row for each voltage level. Change the value of **Rows** to add or remove rows.

**Tstart (C)**

The temperature at which the slope applies. To add a temperature-slope pair, add two columns to the table. Change the value of **Cols** to add or remove rows. Acceptable values for the number of columns are 5, 7, and 9.

**Slope (1/C)**

The slope of the curve beginning at the start temperature.

**Update plot**

After change values in the table,click Update plot to change the graph.

## Inverter Part Load Curve

The Inverter Part Load Curve model allows you to model an inverter by entering part-load efficiency and other data from a manufacturer's data sheet. Unlike the CEC Database and Inverter Datasheet inverter models, this model is not based on the Sandia inverter model. Instead, it determines the inverter's hourly conversion efficiency based on the part-load efficiency data points and night-time loss values you provide.

**Note.** If you do not have a table of part-load efficiency values for the inverter, you may want to use the [Inverter Datasheet model](#) instead of the Part Load Curve model.

**To use the Inverter Part Load Curve model:**

1. On the Inverter page, choose **Inverter Part Load Curve**.
2. Type a value for the **Maximum AC output power**, and choose **CEC efficiency** or **European efficiency**.
3. Type values for the **Operating Ranges** input variables and for **Power consumption at night loss**.
4. Type values in the part-load efficiency table and for the operating range input variables.  
See below for descriptions of the variables, and more detailed instructions for working with the part-load efficiency table.

## **Power Ratings**

**Maximum AC output power**

The inverter's rated maximum AC output in Watts. Manufacturers may use different names for this value, such as continuous output power, rated active power, peak output, etc.

**CEC efficiency and European efficiency**

Specify the inverter's weighted efficiency calculated with either the European or CEC method. The European method is best for locations with lower solar resource where the inverter operates more often at lower load levels. The CEC method is best for sunnier locations where the inverter operates at higher load levels. See [Weighted and Manufacturer Efficiency Values](#) for more details.

### Maximum DC input power

SAM calculates and displays the equivalent rated DC input capacity based on the maximum AC output power and efficiency value that you specify (either weighted or nominal):

$$\text{Maximum DC Input Power (}W_{dc}\text{)} = \text{Maximum AC Output Power (}W_{ac}\text{)} \div \text{Efficiency (\%)} \times 100\%$$

SAM uses the maximum DC input power value to size the array when you choose **Specify desired array size** on the [System Design](#) page, and to display sizing messages when you choose **Specify modules and inverters**.

## Operating Ranges

SAM uses the operating range variables to help you size the system on the [System Design](#) page.

### Nominal AC operating voltage

The inverter's nominal AC output voltage.

### Maximum DC voltage

The inverter's maximum input DC voltage.

### Maximum DC current

The inverter's maximum input DC current.

### Minimum MPPT DC voltage

The inverter's minimum DC operating voltage.

### Nominal DC voltage

The inverter's nominal DC operating voltage.

### Maximum MPPT DC voltage

The inverter's maximum DC operating voltage.

### Number of MPPT inputs

The number of maximum power point tracking (MPPT) inputs in the system. In the actual system, the MPPT hardware may be integrated with the inverter, or separate devices.

In order to model the operating voltage of each input separately, you should assign each MPPT input to a separate subarray on the [System Design](#) page.

## Losses

The two loss variables account for electricity consumed by inverter components to keep the inverter in standby mode at night when the array is not generating electricity.

### Power consumption at night

Electricity consumed by the inverter during the night when the photovoltaic array is not generating power. This value is sometimes also called tare loss or standby loss.

## Part Load Efficiency

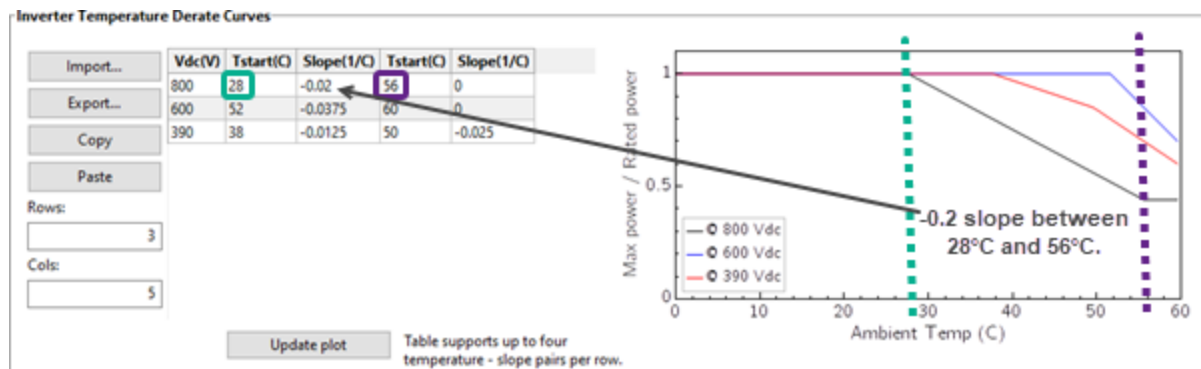
SAM uses the part-load efficiency table you specify to determine the inverter's efficiency during a simulation. You can either type values in the table by hand, import values to the table from a properly formatted text file, or paste data to the table from your computer's clipboard.

SAM uses linear interpolation to calculate efficiency values for output power levels between the points in the table. If you specify only a single row, SAM assumes that the inverter's efficiency is constant over its full output power range.

## Inverter Temperature Derate Curves

SAM uses the information in the inverter temperature derate curves with ambient temperature data from the weather file to adjust the inverter efficiency in each time step of the simulation. As ambient temperature increases, the inverter efficiency decreases based on the data in the table. Inverter efficiency decreases more rapidly with temperature increase at higher operating voltages.

If your inverter datasheet does not provide detailed temperature data, you can use the default data shown in this screenshot:



The temperature derate curve for each voltage level in the table is defined by a start temperature and slope. You can include up to four temperature-slope value pairs in the table. The default data has two temperature-slope pairs and three voltage levels.

### Vdc (V)

The operating temperature for the temperature derate curve. Assign one row for each voltage level. Change the value of **Rows** to add or remove rows.

### Tstart (C)

The temperature at which the slope applies. To add a temperature-slope pair, add two columns to the table. Change the value of **Cols** to add or remove rows. Acceptable values for the number of columns are 5, 7, and 9.

### Slope (1/C)

The slope of the curve beginning at the start temperature.

### Update plot

After change values in the table,click Update plot to change the graph.

## Tips for Working with the Part-load Efficiency Table

- To clear the table, change **Rows** to 1, and then change it to the number of rows in your data set.
- Double click a cell to select it.
- Use the Tab and Shift-Tab keys to move between columns.
- Use the Enter key to move down a column.
- If you type a non-numeric character, SAM replaces the character with a zero.

**To specify the part-load efficiency curve using the table:**

1. Under Rows, type the number of data points you want to include in the table. You must specify at least one row of values in the table.
2. For each row in the table, type a value for output power as a percentage of the inverter's rated capacity, and a DC to AC conversion efficiency value as a percentage.  
SAM displays the part-load efficiency curve in the plot area as you type values in the table.

**To import part-load efficiency data from a text file:**

1. Prepare a text file of comma-separated values. The file should have one line for each output-efficiency value pair separated by a comma with no header rows. For example:  
0,0  
10,96.1  
20,97.55  
30,97.87  
...  
The output percentages should increase from the first row to the last, but not necessarily in equal increments.  
You can also export the efficiency data from the default flat plate photovoltaic case to see an example of what the file should look like.
2. Click **Import**.  
SAM populates the part-load efficiency table with data from the file.

**To paste part-load efficiency data from your computer's clipboard:**

1. Prepare a spreadsheet file or text file with one row for each output-efficiency pair, and output and efficiency values in separate columns or separated by a tab.
2. In your spreadsheet program or text editor, select the two columns containing the data. Do not include column headings or other labels or data.
3. In SAM, on the Inverter page under **Part Load Efficiency**, click **Paste**.  
SAM populates the part-load efficiency table with data from the clipboard.

**Inverter CEC Coefficient Generator**

The CEC Coefficient Generator model generates coefficients for the CEC (Sandia) inverter model from data that you provide from results of inverter performance tests.

- For a description of the Sandia inverter model, see King D et al (2007) Performance Model for Grid-Connected Photovoltaic Inverters, Sandia National Laboratories, SAND2007-5036 ([PDF 1.3 MB](#))
- For a description of the protocol for the inverter performance tests, see Bower, W.; Whitaker, C.; Erdman, W.; Fitzgerald, M. (Draft 2014). Performance Test Protocol for Evaluating Inverters Used in Grid-Connected Photovoltaic Systems. ([PDF 584 KB](#)).
- Examples of test data for inverters are available from the Go Solar California website at: [http://www.gosolarcalifornia.ca.gov/equipment/inverter\\_tests/summaries/](http://www.gosolarcalifornia.ca.gov/equipment/inverter_tests/summaries/).

- The default test data is from the SMA America SB3800TL-US-22 (240V) inverter's April 8, 2013 test data published on the Go Solar California website ([PDF 100 KB](#)). This is the same inverter as the default choice for the [Inverter CEC Database](#), so you can use the defaults for comparisons between the different models, and to learn how to use the test data in SAM.

#### **To use the Inverter CEC Coefficient Generator model:**

1. On the Inverter page, choose **Inverter CEC Coefficient Generator**.
2. Enter values for Maximum AC power and populate the inverter efficiency data table.
3. Click **Calculate Coefficients** to generate the Sandia inverter model coefficients.
4. Enter values for the array sizing inputs.
5. Choose inputs to design the rest of the photovoltaic system and run a simulation.

### **Coefficient Generator Inputs**

These are the data from the test results.

#### **Maximum AC power (Wac)**

The inverter's rated maximum continuous output power in AC Watts, as defined in the test protocol Section 5.4.

#### **Power units**

The units of power of the output power data in the efficiency data table: Choose Watts or kilowatts.

#### **Number of samples**

The number of measured samples. The CEC test protocol requires a minimum of five samples. For each sample, SAM displays three columns in the table: Power out, Voltage in, and Efficiency.

#### **Calculate Coefficients**

Runs the coefficient calculator. Click the button after populating the data table.

#### **Import / Export / Copy / Paste**

Use these buttons to import data from a CSV file, or to export the data to a CSV file. To see the format of the CSV file, export the default data to a file, and then open it in a text editor or spreadsheet program.

### **Inverter Efficiency Data Table**

The inverter efficiency data table consists of output power and input voltage measured in Step 6 of the procedure described in Section 5.5.1 of the CEC test protocol, and the efficiency from Table 5-3 of the protocol.

### **Array Sizing Inputs**

SAM uses the array sizing inputs to display sizing messages on the System Design page, and to calculate inverter clipping losses.

#### **Pnt, W**

Power in Watts consumed at night when the inverter is not converting power. It is defined in Section 5.7 of the CEC test protocol as the AC power from the grid required to operate the inverter in standby mode.

#### **Vdcmx**

The maximum input voltage specified by the inverter manufacturer, from Table 5-2 of the CEC test protocol.



**Idcmax**

The maximum input current specified by the inverter manufacturer.

**MPPT Low and MPPT High**

The operating voltage range of the maximum power point tracker, as described in Section 5.3.1.2 of the CEC test protocol.

**Number of MPPT inputs**

The number of maximum power point tracking (MPPT) inputs in the system. In the actual system, the MPPT hardware may be integrated with the inverter, or separate devices.

In order to model the operating voltage of each input separately, you should assign each MPPT input to a separate subarray on the [System Design](#) page.

**Results - Efficiency Curve and Characteristics**

The results are the Sandia inverter model input parameters. For details, see King (2007) referenced above.

**CEC weighted efficiency and European weighted efficiency, %**

SAM calculates and displays both the CEC weighted efficiency and European weighted efficiency for your reference. It does not use these efficiency values during a simulation. To calculate the efficiencies, SAM calculates the inverter's nominal efficiency at seven different power levels, and applies the set of weighting factors for the CEC and European methods of calculating the [weighted efficiency](#).

**Pdco, Wdc**

Input DC power level at which the inverter's output is equal to the maximum AC power level.

**Psc0, Wdc**

DC power required for the inverter to start converting DC electricity to AC. Also called the inverter's self-consumption power. Sometimes available from manufacturer specifications, and not to be confused with the nighttime AC power consumption.

**Vdco, Vdc**

The average of MPPT-low and MPPT-high, as described in the CEC test protocol (see reference above).

The four coefficients C0..C3 are empirically-determined coefficients calculated by the coefficient generator:

**C0, 1/V**

Defines the relationship between AC and DC power levels at the reference operating condition.

**C1, 1/V**

Defines the value of the maximum DC power level.

**C2, 1/V**

Defines the value of the self-consumption power level.

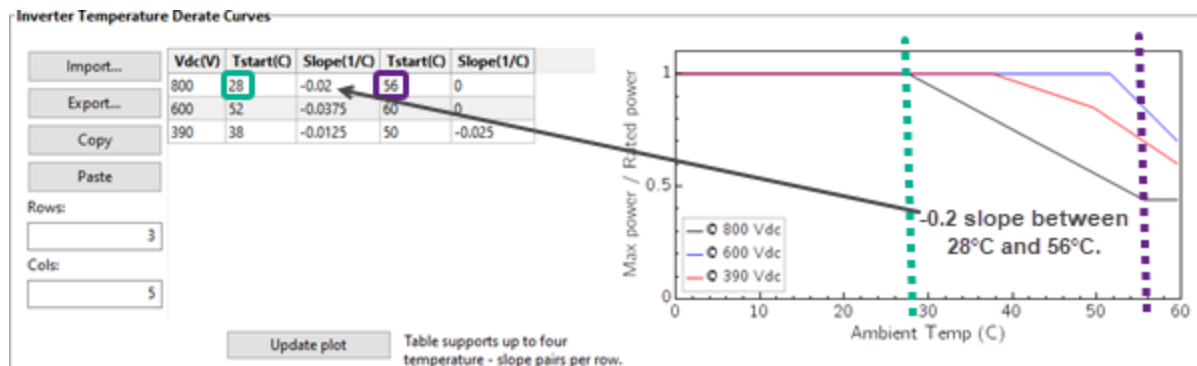
**C3, 1/V**

Defines the value of Coefficient C0.

**Inverter Temperature Derate Curves**

SAM uses the information in the inverter temperature derate curves with ambient temperature data from the weather file to adjust the inverter efficiency in each time step of the simulation. As ambient temperature increases, the inverter efficiency decreases based on the data in the table. Inverter efficiency decreases more rapidly with temperature increase at higher operating voltages.

If your inverter datasheet does not provide detailed temperature data, you can use the default data shown in this screenshot:



The temperature derate curve for each voltage level in the table is defined by a start temperature and slope. You can include up to four temperature-slope value pairs in the table. The default data has two temperature-slope pairs and three voltage levels.

### Vdc (V)

The operating temperature for the temperature derate curve. Assign one row for each voltage level. Change the value of **Rows** to add or remove rows.

### Tstart (C)

The temperature at which the slope applies. To add a temperature-slope pair, add two columns to the table. Change the value of **Cols** to add or remove rows. Acceptable values for the number of columns are 5, 7, and 9.

### Slope (1/C)

The slope of the curve beginning at the start temperature.

### Update plot

After change values in the table,click Update plot to change the graph.

## Weighted Efficiency

When you use either the Inverter Datasheet model or the Inverter Part Load Curve model, you must provide SAM with an efficiency value that determines the inverter's maximum DC input power that SAM uses for sizing the photovoltaic array.

Inverter manufacturers often show several efficiency values on an inverter's data sheet. Weighted efficiency values are more accurate representations of an inverter's efficiency over a range of output levels than an efficiency value at a single operating point.

Many inverter data sheets will show two versions of the weighted efficiency value: The CEC weighted efficiency, which comes from the [CEC Inverter Test Protocol](#) and is discussed in Newmiller (2014) Sandia Inverter Performance Test Protocol Efficiency Weighting Alternatives ([PDF 200 KB](#)), or the European weighted efficiency discussed in Ongun (2013) Weighted Efficiency Measurement of PV Inverters: Introduction *ismir* ([PDF 1.8 MB](#)). The table below shows the weighting factors used to determine both versions of the weighted efficiency. In general, you should use the CEC weighted efficiency to model a system in a sunny location, and you should use the European weighted efficiency for less sunny locations. The following equation shows how the weighted efficiency is calculated, where *weighted* is the weighted

efficiency value, F1..F7 are shown in the table below, and 5, 10... are the inverter part-load efficiencies at 5%, 10%... of maximum AC output:

$$\text{weighted} = F1 \times 5 + F2 \times 10 + F3 \times 20 + F4 \times 30 + F5 \times 50 + F6 \times 75 + F7 \times 100$$

### Weighting Factors for CEC and European Weighted Inverter Efficiencies

Percent of Inverter Maximum AC Output	Factor	CEC Weighting Factor	European Weighting Factor
5	F1	0.00	0.03
10	F2	0.04	0.06
20	F3	0.05	0.13
30	F4	0.12	0.10
50	F5	0.21	0.48
75	F6	0.53	0.00
100	F7	0.05	0.2

## 8.6.3 System Design

Use the System Design variables to size the photovoltaic system and choose tracking options. If your system includes battery storage, configure the battery bank on the [Battery Storage](#) page.

### Notes.

See [PV Sizing and Configuration](#) for configuration examples and sizing tips.

Run the **System Sizing macro** to generate a report to help you ensure the system is sized correctly.

Before sizing the system, choose a [module](#) and [inverter](#) for the system. SAM can only model systems with one type of module and one type of inverter.

Choosing an appropriate module and inverter for your system depends on many factors, some of which are outside of the scope of SAM. Finding the right combination of inverter and module to model for your system in SAM will probably require some trial and error and iteration.

Reference conditions depend on the conditions used to define the parameters on the [Module](#) page. For the Sandia and CEC module models, reference conditions are 1,000 W/m<sup>2</sup> incident radiation and 25°C cell temperature

### Basic Sizing Steps:

1. Choose a [module](#) and [inverter](#).
2. Type a value for **Number of inverters** under **AC Sizing**.

3. For each subarray in the system, type a value for **Modules per string in subarray**, ensuring that the string's rated open-circuit voltage (Voc) does not exceed the inverter maximum MPPT voltage rating.
4. For each subarray, type a value for **Number of strings in parallel** to achieve the desired DC to AC ratio.

## AC Sizing

The AC Sizing inputs determine the AC rating of the system.

### Number of inverters

The total number of inverters in the system, which determines the total inverter capacity. SAM assumes that all inverters in the system are connected in parallel so that the inverter bank's rated voltage limits are the same as those of a single inverter. The current version of SAM does not model string inverters with different voltages.

**Note.** If you are modeling a system with microinverters, see [Modeling Microinverters](#) for instructions. For systems with multiple power point trackers, see [Systems with Multiple Power Point Trackers](#).

### DC to AC ratio

The ratio of total inverter DC capacity to total AC capacity. This is a value that SAM calculates and displays for reference.

High DC to AC ratios may result in inverter power clipping.

### Estimate Subarray 1 configuration

This option allows you to type a desired value for the system nameplate capacity and a desired DC to AC ratio. When you check this option, for **Desired Array Size**, type the DC capacity, and for **DC to AC Ratio**, type the ratio of nameplate capacity (DC kW) to total inverter capacity (AC kW) you want for your system.

SAM calculates the number of modules and inverters to get as close as possible to the desired size. Use this option for a rough estimate of an array layout. For a more about sizing the system, see [PV Sizing and Configuration](#).

**Note.** The desired array size and DC to AC ratio is likely to be different from the actual Nameplate capacity and DC to AC ratio because the desired array size is typically not an even multiple of the module capacity.

## Sizing Summary

The sizing summary variables are values SAM calculates based on the inputs you specify. Use these values to verify that the system is sized correctly.

### Total AC capacity, kWac

The total inverter capacity in AC kilowatts:

$$\text{Inverter Total Capacity (kWac)} = \text{Inverter Maximum AC Power (Wac)} \times 0.001 \text{ (kW/W)} \times \text{Number of Inverters}$$

The inverter's nominal AC power rating is from the [Inverter](#) page.

**Total inverter DC capacity, kWdc**

The total inverter capacity in DC kilowatts:

$$\text{Inverter Total Capacity (kWdc)} = \text{Inverter Maximum DC Input Power (Wdc)} \times 0.001 \text{ (kW/W)} \times \text{Number of Inverters}$$

The inverter's maximum DC input power is from the the [Inverter](#) page.

**Nameplate DC capacity, kWdc**

The maximum DC power output of the array at the reference conditions shown on the [Module](#) page:

$$\text{Nameplate Capacity (kWdc)} = \text{Module Maximum Power (Wdc)} \times 0.001 \text{ (kW/W)} \times \text{Total Modules}$$

The module's maximum power rating is from the [Module](#) page. The number of modules is the value listed under **Actual Layout**.

**Total number of modules**

The number of modules in the array:

$$\text{Total Modules} = \text{Modules per String} \times \text{Strings in Parallel}$$

The numbers of modules and strings are the values listed under **Actual Layout**.

**Total number of strings**

The number of strings of modules in the array.

**Total module area, m<sup>2</sup>**

The total area in square meters of modules in the array, not including space between modules:

$$\text{Total Area (m}^2\text{)} = \text{Module Area (m}^2\text{)} \times \text{Number of Modules}$$

The area of a single module is from the [Module](#) page.

**DC Sizing and Configuration**

The DC Sizing and Configuration inputs determine the size and configuration of the photovoltaic array and its orientation and tracking. The array may consist of up to four subarrays, or sections, each of which may have different string lengths, orientation, and tracking.

For more about sizing and configuration, see [PV Sizing and Configuration](#).

**Systems with Multiple Maximum Power Point Trackers (MPPT)**

If you enable more than one subarray, SAM calculates a separate operating voltage for each subarray. If your inverter has more than one MPPT input, you should set **Number of MPPT inputs** on the [Inverter](#) page to the number of inverter inputs you plan to use. You can then connect each subarray to a different inverter input using **Inverter MPPT input for subarray** so that each MPPT input operates at its own voltage. If your inverter has a single MPPT input and you enable more than one subarray, SAM calculates the inverter input voltage using the method you choose for [PV Subarray Voltage Mismatch](#).

**Notes.**

SAM only allows systems with multiple MPPTs to have one inverter.

The term "MPPT input" refers to the electrical connection to a maximum power point tracker (MPPT). The MPPT electrical circuit in your system may be integrated with the inverter or in a separate device. In either case, use the Number of MPPT inputs on the [Inverter](#) page to represent the number of MPPT circuits in your system.

If you are using an inverter with more than one MPPT input, you can use the **Set subarrays for multiple MPPT** button to automatically enable the number of subarrays you need and assign values to **Inverter MPPT for subarray**.

## Electrical Configuration

### Enable

If your system has a single subarray, you do not need to enable additional subarrays. Subarray 1 is always enabled.

If your system has more than one subarray, for example, for different sections of a roof-top array with different orientations, then you should check **Enable** for each of up to four subarrays.

### Modules per string in subarray

The number of modules connected in series in a single string for each subarray.

The number of modules per string determines the subarray's open circuit string voltage (Voc) and maximum power rated string voltage (Vmp):

$$\text{Subarray Voc (V)} = \text{Module Voc (V)} \times \text{Modules Per String in Subarray}$$

$$\text{Subarray Vmp (V)} = \text{Module Vmp (V)} \times \text{Modules Per String in Subarray}$$

As an initial rule of thumb, choose a number of modules per string so that the string Voc is less than the inverter's maximum DC voltage rating, and the string Vmp is between the inverter's minimum and maximum MPPT voltage rating. You can run a simulation and look at the operating voltages in the results to see how they compare to the voltage ratings. You can also use the System Sizing [macro](#) to refine your design.

### Strings in parallel in subarray

The number of strings of modules connected in parallel to form a subarray.

Once you specify the number of modules per string to determine the subarray's string voltage, the number of strings in parallel and number of subarrays determine the system nameplate DC capacity in kilowatts:

$$\text{Modules per Subarray} = \text{Modules per String in Subarray} \times \text{String in Parallel in Subarray}$$

$$\text{Total Number of Modules} = \text{Modules per Subarray} \times \text{Number of Subarrays}$$

$$\text{Nameplate DC Capacity (kW)} = \frac{\text{Total Number of Modules} \times \text{Module Maximum Power (W)}}{1000} \text{ (W/kW)}$$

For each subarray that has more than one string in parallel, SAM calculates the subarray voltage using the [PV subarray voltage](#) mismatch method you choose.

### Number of modules in subarray

The number of modules in each subarray depends on the number of modules per string, and number of strings in parallel in each subarray:

$$\text{Number of Modules in Subarray} = \text{Modules per String in Subarray} \times \text{Strings in Parallel in Subarray}$$

$$\text{Total Number of Modules} = \text{Sum of Number of Modules in Subarrays 1 - 4}$$

### String Voc at reference conditions, V

The open circuit DC voltage of each string of modules at the module reference conditions shown on the [Module](#) page:

$$\text{String Voc (V)} = \text{Module Open Circuit Voltage (V)} \times \text{Modules per String}$$

### String Vmp at reference coinditions, V

The DC voltage at the module maximum power point of each string of modules at the module reference conditions shown on the [Module](#) page:

$$\text{String Vmp (Vdc)} = \text{Module Max Power Voltage (Vdc)} \times \text{Modules per String}$$

### Inverter MPPT input for subarray

If the **Number of MPPT inputs** on the [Inverter](#) page is greater than one, type the input number for each subarray. For example, if the inverter has two MPPT inputs, you could assign Subarray 1 to the inverter's Input 1, and Subarray 2 to the inverter's Input 2. See the note above about the term "MPPT input."

## Tracking & Orientation

The four tracking options allow you specify whether and how modules in each subarray follow the movement of the sun across the sky.

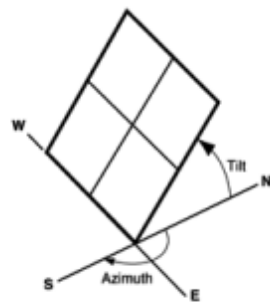
**Note.** SAM does not adjust installation or operating costs on the [System Costs page](#) based on the tracking options you specify. Be sure to use appropriate costs for the type of tracking system you specify.

#### Fixed

The subarray is fixed at the tilt and azimuth angles defined by the values of **Tilt** and **Azimuth** and does not follow the sun's movement.

#### 2 Axis

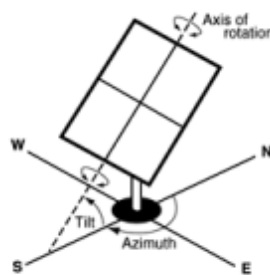
The subarray rotates from east in the morning to west in the evening to track the daily movement of the sun across the sky, and north-south to track the sun's seasonal movement throughout the year. For two-axis tracking, SAM ignores the values of **Tilt** and **Azimuth**.



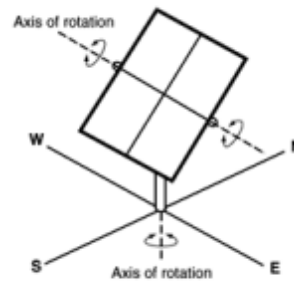
PV array facing south at fixed tilt.

### 1 Axis

The subarray is fixed at the angle from the horizontal defined by the value of **Tilt** and rotates about the tilted axis from east in the morning to west in the evening to track the daily movement of the sun across the sky. **Azimuth** determines the array's orientation with respect to a line perpendicular to the equator. For a horizontal subarray with one-axis tracking, use a **Tilt** value of zero.



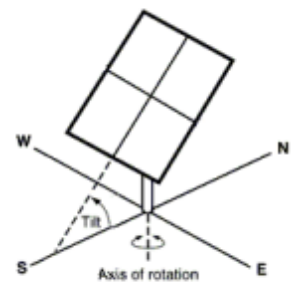
One axis tracking PV array with axis oriented south.



Two-axis tracking PV array

### Azimuth Axis

The subarray rotates in a horizontal plane to track the daily movement of the sun. SAM ignores the value of **Azimuth**.



Azimuth-axis tracking PV array

### Tilt = Latitude

Assigns the array tilt value with the latitude value stored in the weather file and displayed on the [Location and Resource](#) page. Note that SAM does not display the tilt value on the System Design page, but does use the correct value during the simulation.

The tilt value is positive, so for southern latitudes, SAM sets the tilt angle to the negative value of tilt.

### Tilt, degrees

Applies only to fixed arrays and arrays with one-axis tracking. The array's tilt angle in degrees from horizontal, where zero degrees is horizontal, and 90 degrees is vertical.

As a rule of thumb, system designers sometimes use the location's latitude (shown on the Location and Resource page) as the optimal array tilt angle. The actual tilt angle will vary based on project requirements. You can run a [parametric analysis](#) on the ground coverage ratio on tilt to find its optimal value.



For a horizontal array, use a tilt angle of zero.

### Azimuth, degrees

The azimuth angle determines the array's east-west orientation for fixed arrays and arrays with one-axis tracking. For a fixed tilted array, an azimuth value of zero is facing north, 90 degrees = east, 180 degrees = south, and 270 degrees = west, regardless of whether the array is in the northern or southern hemisphere. See the diagrams above

For systems north of the equator, a typical azimuth value would be 180 degrees. For systems south of the equator, a typical value would be 0 degrees.

**Note.** This convention is different than that used in older versions of SAM. Please be sure to use the correct array azimuth angle convention.

### Ground coverage ratio (GCR)

The ratio of the photovoltaic array area to the total ground area. For an array configured in rows of modules, the GCR is the length of the side of one row divided by the distance between the bottom of one row and the bottom of its neighboring row. An array with a low ground coverage ratio (closer to zero) has rows spaced further apart than an array with a high ground coverage ratio (closer to 1).

The ground coverage ratio must be a value greater than 0.01 and less than 0.99.

SAM uses the GCR to estimate [self-shading losses](#) for fixed and one-axis trackers, determine when to backtrack for one-axis trackers with backtracking enabled, and to estimate the array's land requirement for [system cost](#) calculations.

To see the effect of the ground coverage ratio on the system's performance, after running a simulation, you can compare the time series results Nominal POA total irradiance ( $\text{kW}/\text{m}^2$ ) and POA total irradiance after shading only ( $\text{kW}/\text{m}^2$ ). You can also run a [parametric analysis](#) on the ground coverage ratio value to find its optimal value.

### Tracker Rotation Limit, degrees

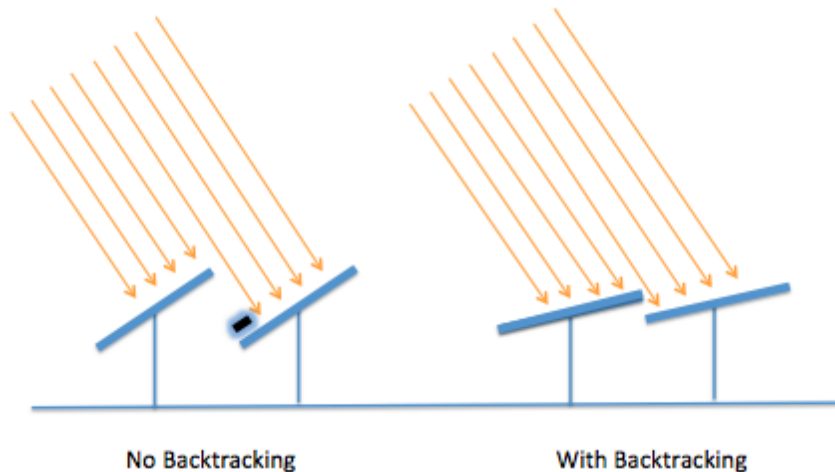
For one-axis trackers, the maximum and minimum allowable rotation angle. A value of 45 degrees would allow the tracker to rotate 45 degrees about the center line in both directions from the horizontal.

### Backtracking

Backtracking is a one-axis tracking strategy that avoids row-to-row shading.

Without backtracking, a one-axis tracker points the modules toward at the sun. For an array with closely spaced rows, modules in adjacent rows will shade each other at certain sun angle. With backtracking, under these conditions, the tracker orients the modules away from the sun to avoid shading.

The following diagram illustrates how backtracking avoids row-to-row shading for a simple array with two rows:



## Electrical Sizing Information and System Sizing Messages

### Maximum DC voltage, Vdc

The inverter's maximum rated input DC voltage from the [Inverter](#) page.

For systems with more than one inverter, SAM assumes that inverters are connected in parallel so that the rated voltages of the inverter bank are the same as those of a single inverter.

### Minimum MPPT voltage and Maximum MPPT voltage, Vdc

The inverter minimum and maximum operating voltages, as specified by the manufacturer, from the [Inverter](#) page.

The sizing messages do not prevent you from running a simulation.

Maximum DC voltage	<input type="text" value="480.0"/>	Vdc
Minimum MPPT voltage	<input type="text" value="220.0"/>	Vdc
Maximum MPPT voltage	<input type="text" value="480.0"/>	Vdc

Voltage and capacity ratings are at module reference conditions shown on the Module page.

Subarray 1 string voltage exceeds the inverter maximum rated voltage at reference conditions. Consider using fewer modules per string.

The sizing messages display the following information for each subarray:

- DC to AC ratio based on the array and inverter capacities:  

$$\text{Actual DC to AC Ratio} = \frac{\text{Total Nameplate Array Capacity in DC kW}}{\text{Total Nameplate Inverter Capacity in DC kW}} \times 100\%$$
- Array string open circuit voltage exceeds inverter maximum DC voltage:  

$$\text{String Voc} > \text{Inverter Maximum DC Voltage}$$
- Array string maximum power voltage exceeds the inverter maximum MPPT voltage:  

$$\text{String Vmp} > \text{Maximum Inverter MPPT Voltage}$$
- Array string maximum power voltage is less than the inverter minimum MPPT voltage:  

$$\text{String Vmp} < \text{Minimum Inverter MPPT Voltage}$$

## Estimate of Overall Land Usage

SAM calculates an estimated land area required by the array in acres for any land-related costs you specify on the System Costs page in \$/acre.

### Total module area, m<sup>2</sup>

The product of the area of a single module and the number of modules in the system.

### Total land area, acres

An estimate of the land area required for the array, not including additional land for balance of system equipment.

$$\text{Total Land Area (acres)} = \text{Total Module Area (m}^2\text{)} \div \text{GCR} \times 0.0002471 \text{ acre/m}^2$$

## PV Subarray Voltage Mismatch

The subarray mismatch option is an advanced option that calculates the effect of voltage mismatch between subarrays for systems with two or more subarrays.

Because the number of modules per string is the same for all subarrays in the system, the subarrays have the same nominal string voltage. However, during operation each subarray is exposed to different radiation levels and wind speeds, which causes the cell temperatures in each subarray to differ. Because cell voltage depends on cell temperature, each subarray will have slightly different voltages. This voltage mismatch causes electrical losses so that the inverter input voltage is less than the array's maximum power voltage.

SAM uses two methods to estimate the inverter input voltage.

### Averaging Method (check box clear)

SAM calculates each subarray's output at its maximum power point voltage ( $V_{mp}$ ), and assumes that the inverter DC input voltage is the average of the subarray  $V_{mp}$  values.

This method is fast and works with both the Sandia and CEC module option.

### Iterative Method (check box checked)

SAM tries many string voltages to find the value that results in the maximum power from the array. For each test voltage, it finds the current from each subarray, and adds up the currents. Then the power is the summed current times the test voltage. The test voltage that yields the maximum power is used for each subarray to calculate the total output power, and this voltage is also the inverter DC input voltage.

This method takes on the order of 10-30 seconds for a system with two or more subarrays.

### Notes.

The subarray mismatch option is only active with the CEC model option on the [Module](#) page.

The iterative method typically results in lower system output over the year than the averaging method. The averaging method is a reasonable approximation of mismatch losses, and is suitable for simulations where the main metric of interest is the system's total annual output for financial analysis. The difference in annual output between the two methods is often less than one percent.

## 8.6.4 Shading and Layout

Shading and snow losses are reductions in the incident irradiance caused by shadows or snow on the photovoltaic modules in the array.

### Overview

SAM can model the impact of a reduction in plane-of-array irradiance on each subarray caused by external shading, self shading, and snow cover. This overview describes each, with links to the sections below that list and describe the inputs.

#### Notes.

The monthly soiling losses on the [Losses](#) page also reduce the irradiance incident on the array. When comparing incident plane-of-array irradiance data, be sure to take soiling losses into account.

The self-shading model does not work with the **Simple Efficiency Module** model on the [Module](#) page.

### External Shading

[External shading](#) is shading of the photovoltaic subarray by trees, buildings, roof protrusions and other nearby objects. SAM represents a shadow on the subarray in a given time step by a single **beam irradiance shading loss** for that time step, which it determines from data you provide in the beam shade loss tables in the [Edit Shading Data window](#). SAM reduces the plane-of-array beam irradiance by the shading loss percentage. For example, if a shadow occupies 25% of the subarray's surface area at 11 am, the beam shading loss for 11 am would be 25%. A shading loss of 0 means there is no shade on the subarray, and a loss of 100% means that no beam irradiance reaches the subarray.

When you specify beam irradiance shading losses by time step, you can use SAM's partial shading model to estimate the impact of partial shading on the array's electrical output. The partial shading model does not work with the month-by-hour or solar azimuth-by-altitude beam shade loss tables. For more information about the partial shading model, see MacAlpine, S.; Deline, C. (2015) Simplified Method for Modeling the Impact of Arbitrary Partial Shading Conditions on PV Array Performance. National Renewable Energy Laboratory. 8 pp.; NREL/CP-5J00-64570. ([PDF 699 KB](#))

SAM accounts for the effect of external shading on the plane-of-array diffuse irradiance using a single **sky diffuse shading loss** for the entire year.

You can generate beam and diffuse irradiance shading loss data using SAM's [3D Shade Calculator](#) or outside of SAM. SAM can [import beam and diffuse shading data](#) from files created by PVSyst, and beam shading data from files created by the Solmetric Suneye, and Solar Pathfinder software.

Use the following output variables to explore the effect of external shading (see [Results](#) for descriptions of the variables):

- **Subarray [1..4] External shading and soiling beam irradiance factor (frac)** (except for partial shading model)
- **Subarray [1..4] Partial external shading DC factor (frac)** (for partial shading model only)
- **Subarray [1..4] POA total irradiance after shading only (W/m2)**
- **Array POA beam radiation after shading only (kW)**

### Self Shading

[Self shading](#) is caused by row-to-row shading of modules within a subarray, where shadows from modules in neighboring rows of the array block sunlight from parts of other modules in the array during certain times of day. SAM can estimate self shading for fixed subarrays and subarrays with one-axis tracking, assuming that each subarray consists of modules in parallel rows with the same number of modules per row.

For a description of the self-shading model implemented in SAM, see Gilman, P.; Dobos, A.; DiOrto, N.; Freeman, J.; Janzou, S.; Ryberg, D. (2018) SAM Photovoltaic Model Technical Reference Update. 93 pp.; NREL/TP-6A20-67399 available along with other technical documentation from the [SAM website](#).

Use the following output variables to explore the effect of self shading (see [Results](#) for descriptions of the variables):

- **Subarray [1..4] Self-shading linear beam irradiance factor** (thin film linear only)
- **Subarray [1..4] Self-shading non-linear DC factor** (standard non-linear only)
- **Subarray [1..4] Self-shading non-linear sky diffuse irradiance factor** (standard non-linear only)
- **Subarray [1..4] Self-shading non-linear ground diffuse irradiance factor** (standard non-linear only)

## Snow Losses

When your weather file contains snow depth data, SAM can estimate [snow losses](#) in the array's output caused by snow covering the modules in the subarray.

## Shading and Snow Inputs

### 3D Shade Calculator

The SAM 3D Shade Calculator uses a sun position algorithm and a three-dimensional drawing of a photovoltaic array and nearby shading objects to generate hour-by-month tables of beam irradiance shade loss percentages, and a sky diffuse loss percentage. It has the following features:

- Uses Bing Maps geocoding to automatically find latitude, longitude, and time zone for any street address.
- A three dimensional drawing, or shade scene, represents the photovoltaic array and nearby shading objects.
- The scene consists of active surfaces (photovoltaic subarrays) and shading objects.
- Four three-dimensional shapes are designed to represent most shading objects: Box, cylinder, tree, and roof.
- View and edit the shade scene in three-dimensional, bird's eye, and elevation views.
- Add an optional aerial photograph from Bing Maps or your own image as an underlay for the bird's eye view to help position objects on the scene.
- Drag the three-dimensional view to see shadows on active surfaces and the shade loss at different sun positions.
- Calculate diurnal and hourly beam irradiance shade loss for a single year based on the scene location and relative positions of each active surface and shading objects in the scene.

#### **To use the SAM shade analysis calculator:**

1. On the [Shading and Layout](#) page (detailed photovoltaic model) or [System Design](#) page (PVWatts), click **Open 3D shade calculator**.
2. [Define the scene location](#) (latitude, longitude, time zone).

3. [Add shading objects](#) to the scene -- these are trees, buildings, and other structures near the array that may block direct solar irradiance from reaching the array.
4. [Add active surface](#) objects to the scene to represent the photovoltaic array or subarrays.
5. [Save and close](#) the calculator to apply shading factor values to the SAM [shading](#) inputs.
6. [Generate shade data](#).
7. [Export shade data](#) to use in SAM or other simulation software.

For more step-by-step instructions, see [How-To](#).

For a description of the 3D shade calculator's features, see [Reference](#).

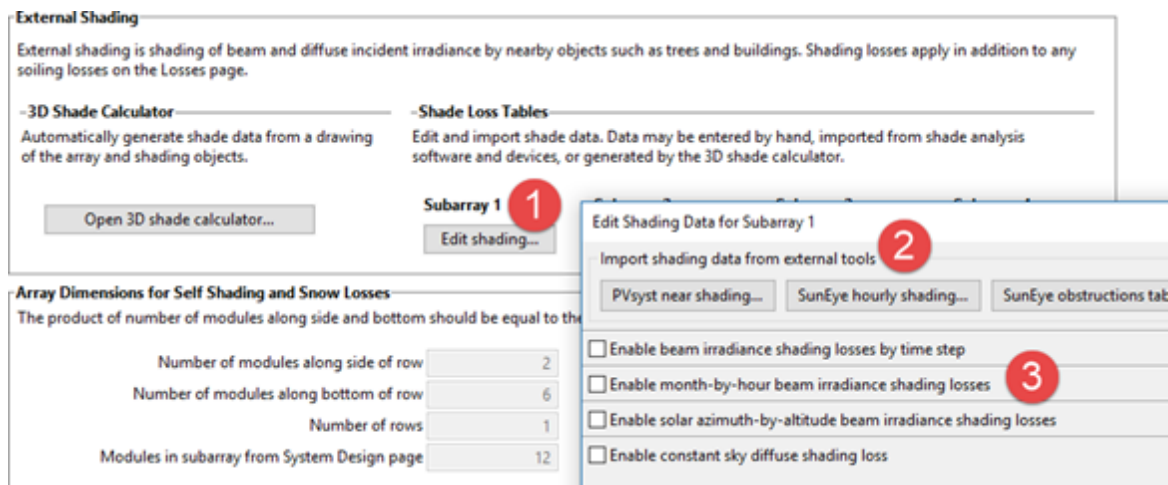
## Shade Loss Tables for External Shading

To model external shading of a subarray in SAM, you provide a set of beam shading loss percentages in one of the beam shade loss tables, and a single sky diffuse shading loss.

### To enable the external shading:

1. Click **Edit Shading** for the subarray for which you want to enable external shading to open the [Edit Shading Data](#) window. (Define the subarrays on the [System Design](#) page.)
2. If you are working with a shading file from PVsyst, Solmetric Suneye, or Solar Pathfinder software, in the Edit Shading window, click the appropriate button under **Import shading data from external tools** to [import the file](#).
3. If you are using a [beam shade loss table](#) to specify shading factors (you can type, import, or paste values into the table), check the appropriate **Enable** box in the Edit Shading window to display the table.

**Note.** SAM does not prevent you from enabling more than one beam shade loss table even if that results in an unrealistic shading model. Be sure to verify that you have enabled the set of shade loss tables you intend before running a simulation.



## Array Dimensions for Self Shading and Snow Losses

To model the effects of self shading and snow cover, SAM needs basic information about the arrangement of modules and rows in each subarray. The total number of modules in each subarray is defined on the

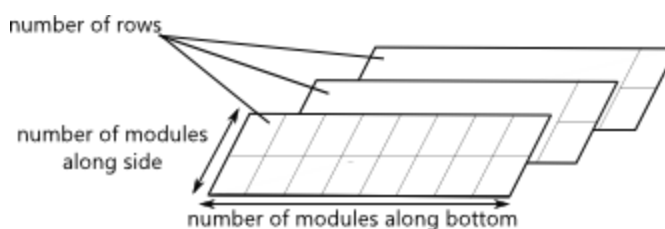
[System Design](#) page.

#### Notes.

The Array Dimensions input are only active for a subarray when you either choose a self-shading option, or check the Snow Losses check box.

SAM assumes that modules in each subarray are laid out in rectangles. It cannot calculate self shading or snow coverage losses for subarrays with irregular shapes.

The array dimensions for self shading and snow coverage are different from the electrical wiring of strings defined on the [System Design](#) page.



#### Number of modules along side of row

The number of modules along the edge of the subarray array perpendicular to the bottom of the array as defined below.

#### Number of modules along bottom of row

The number of modules along the bottom of a row, which is the edge of the row nearest to the ground.

#### Number of rows

The number of rows given the number of modules in the subarray from the [System Design](#) page and the numbers of modules along the side and bottom of row that you specify.

$$\text{Number of Rows} = \text{Number of Modules in Subarray} \div \text{Number of Modules along Side} \div \text{Number of Modules along Bottom}$$

To model a realistic rectangular arrangement of modules, the number of rows should be an integer: The product of the number of modules along the side and bottom of each subarray should be a divisor of the total number of modules in the subarray.

#### Notes.

A subarray with only one row will not experience any self shading.

If the number of rows is one or is not an integer, SAM generates a simulation message but will still run and generate results.

#### Modules in subarray from System Design page

The total number of modules in each subarray, as defined on the [System Design](#) page.

## Self Shading for Fixed Subarrays and One-axis Trackers

The self-shading model estimates the reduction in the array's DC output due to row-to-row shading of modules within the subarray, where shadows from modules in neighboring rows of the array block sunlight from parts of other modules in the array during certain times of day.

The response of a real photovoltaic module to shading is complex, and depends on several factors, including photovoltaic cell material, shape and layout of cells in the module, and configuration of bypass diodes in the module. SAM's self-shading model makes the following simplifying assumptions.

For the **Standard (non-linear)** option:

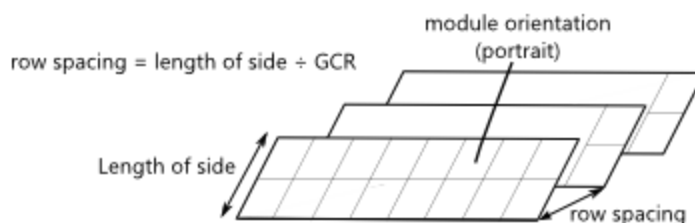
- The cell material is crystalline silicon, either mono-crystalline or poly-crystalline. The self-shading model does not work for modules with thin film cells. SAM indicates the cell material on the [Module](#) page under Physical Characteristics.
- Each module in the array consists of square cells arranged in a rectangular grid with three bypass diodes.
- The array uses the fixed or one-axis tracking option on the [System Design](#) page. The self-shading model does not work for two-axis or azimuth-axis tracking.

For the **Thin film (linear)** option, the subarray's DC output responds linearly to the reduction in plane-of-array irradiance.

The self-shading model does not work with the [Simple Efficiency Module Model](#).

## Self Shading Inputs

The self-shading inputs consist of the [array dimension inputs](#) that apply to both the self shading and snow loss, and the self-shading inputs described below. Those parameters are on the [System Design](#) page.



**Note.** The self shading inputs are only active for fixed subarrays, or for subarrays with 1-axis tracking without backtracking. Self shading is not active for 1-axis trackers with backtracking because backtracking avoids any self shading.

### Self shading

**None** uses the approach of versions of SAM before SAM 2014.1.14. Because this option does not account for any self-shading, it tends to overestimate the array's production. We included this option to allow for comparison between the different options to see the effect of the self-shaded and backtracking options, and for comparison between results from this version and older versions of SAM.

**Standard (non-linear)** is appropriate for most types of modules with crystalline silicon cells. It estimates losses from self-shading caused by shading of modules in one row by modules in neighboring rows based on the GCR value you specify.

**Thin film (linear)** is for modules with thin-film cells or for specially-designed modules with cells and bypass diodes wired in such a way that the modules output varies linearly with shaded area of the module.



**Module orientation**

The module orientation determines whether the short or long side of the module is parallel to the ground, assuming that all modules in the array are mounted at a fixed angle from the horizontal equal to the tilt angle specified on the [System Design](#) page.

Portrait orientation means the short end of the module is parallel to the ground, or at the bottom of the module.

Landscape orientation means the long end of the module is parallel to the ground, or at the bottom of the module.

**Length of side (m)**

The length of the side of a row. The bottom of the row is parallel to the ground, and the side is perpendicular to the bottom.

For portrait module orientation:

$$\text{length of side} = \text{module length} \times \text{number of modules along side of row}$$

For landscape module orientation:

$$\text{length of side} = \text{module width} \times \text{number of modules along side of row}$$

**GCR from System Design page**

Ground coverage ratio from the [System Design](#) page, defined as the length of the side of one row divided by the distance between the bottom of one row and the bottom of its neighboring row.

**Row spacing estimate (m)**

The distance in meters between the bottom of any two rows in the subarray. SAM displays this value for reference. The self-shading calculations use the module area and GCR.

$$\text{row spacing estimate} = \text{length of side} \div \text{GCR}$$

**Module aspect ratio**

The ratio of the module length to module width.

The built-in module libraries for the CEC and Sandia module models contain data for the area of each module, but not for the module length and width. For this reason, you must provide the aspect ratio as an input for the self-shading calculations. You can use the module dimensions for your module from the manufacturer data sheet to calculate the aspect ratio, and compare SAM's calculated values to the values on the data sheet to check your work.

**Module length**

The length of the long side of the module.

$$\text{module length} = \sqrt{(\text{module area} \times \text{module aspect ratio})}$$

**Module width**

The width of the short side of the module.

$$\text{module width} = \sqrt{(\text{module area} \div \text{module aspect ratio})}$$

**Module area**

The module area from the [Module page](#).

**Snow Losses**

For a description of the snow model, see the following publications available along with other technical

documentation from the [SAM website](#):

- Gilman, P.; Dobos, A.; DiOrio, N.; Freeman, J.; Janzou, S.; Ryberg, D. (2018) SAM Photovoltaic Model Technical Reference Update. 93 pp.; NREL/TP-6A20-67399
- Ryberg, D.; Freeman, J. (2017). Integration, Validation and Application of a PV Snow Coverage Model in SAM. National Renewable Energy Laboratory. 33 pp. TP-6A20-68705 available along with other technical documentation from the [SAM website](#).

Use the following output variables to explore the effect of snow cover (see [Results](#) for descriptions of the variables):

- **Array DC power loss due to snow (kW)**
- **Weather file snow depth file (cm)**

**Note.** Snow depth data is not available in the NSRDB PSM V3 dataset. It is available in the [NSRDB 1961 - 1990 Archive Data](#). This older data does not represent the best up-to-date data from the NSRDB, but may be useful for testing SAM's snow loss model.

The Ryberg (2017) paper cited above includes a United States map of annual average snow loss values that could be used to estimate snow loss using inputs on the Losses page instead of the snow model when snow depth data is not available.

SAM's snow model for photovoltaic systems estimates the loss in system output during time steps when the array is covered in snow. It uses snow depth data from the weather file, and for time steps with snow, estimates the percentage of the photovoltaic array that is covered with snow based on the array's tilt angle, plane-of-array irradiance, and ambient temperature. The model assumes that the array is completely covered with snow when the snow depth data indicates a snowfall, and that snow slides off the array as the ambient temperature increases.

#### **Estimate snow losses**

Check this option to model snow losses if the weather file on the [Location and Resource](#) page includes snow depth data.

## **8.6.5 Losses**

The losses inputs account for soiling and electrical losses that the module and inverter models do not account for. After running a simulation, you can see the effect of these losses on [results](#) by displaying the results variables described below in [data tables](#) and [time series graphs](#).

### **Irradiance Losses**

Irradiance losses account for reduction in incident solar irradiance caused by dust or other seasonal soiling of the module surface that reduce the radiation incident on the subarray. Soiling losses cause a uniform reduction in the total irradiance incident on each subarray.

SAM calculates the nominal incident irradiance value for each time step using solar irradiance values from the weather file, and sun and subarray angles. When you specify soiling losses, SAM adjusts the nominal incident irradiance value by each soiling loss percentage that applies to the time step. You can see the effect of soiling losses in hourly results by comparing values of the nominal POA irradiance with the "after

shading only" and "after shading and soiling" values. The radiation incident on the subarray is the POA total irradiance after shading and soiling value ( $W/m^2$ ).

**Note.** Soiling losses apply in addition to any losses you specify on the [Shading and Layout](#) page.

### Monthly soiling loss

Click **Edit values** to specify a set of monthly soiling losses. To apply a single soiling loss to all months to represent a constant loss throughout the year, in the Edit Values window, type a value for **Enter single value** and then click **Apply**.

### Average annual soiling loss

SAM shows the average of the twelve monthly soiling loss values for your reference. It applies the monthly soiling losses during simulations, not the average annual value.

## DC Losses

The DC losses account for DC electrical losses on the DC side of the system that the module model does not calculate, such as electrical losses in the DC wiring that connects modules in the array.

The five DC loss categories (mismatch, diodes and connections, etc) are to help you keep track of factors influencing the total DC loss. You can see the effect of the total DC loss in the hourly results:

$$\begin{aligned} \text{Net DC array power} = & \text{Subarray 1 Gross DC power} \times ( 1 - \text{Subarray 1 Total DC power loss} \div 100\% ) \\ & + \text{Subarray 2 Gross DC power} \times ( 1 - \text{Subarray 2 Total DC power loss} \div 100\% ) \\ & + \text{Subarray 3 Gross DC power} \times ( 1 - \text{Subarray 3 Total DC power loss} \div 100\% ) \\ & + \text{Subarray 4 Gross DC power} \times ( 1 - \text{Subarray 4 Total DC power loss} \div 100\% ) \end{aligned}$$

The five DC loss categories represent the following sources of DC electrical loss for each subarray:

#### Module mismatch, %

Slight differences in performance of individual modules in the array.

#### Diodes and connections, %

Voltage drops across blocking diodes and electrical connections.

#### DC wiring, %

Resistive losses in wiring on the DC side of the system.

#### Tracking error, %

Inaccuracies in the tracking mechanisms ability to keep the array oriented toward the sun. The default value of zero assumes a fixed array with no tracking. Applies only to systems with one- or two-axis tracking arrays.

#### Nameplate, %

Accounts for accuracy of the manufacturer's nameplate rating, often for the performance degradation modules may experience after being exposed to light.

#### DC power optimizer loss, %

Accounts for power losses of any power conditioning equipment installed with the array. SAM does not explicitly model DC/DC conversion losses, but you can account for them here.

The total DC power loss for each subarray represents the subarray's total DC electrical loss:

**Total DC power loss, %**

The total DC power loss is the total loss that applies to each subarray:

$$\begin{aligned} \text{Total DC power loss} = & 100\% \times \{ 1 - [ ( 1 - \text{Mismatch} \div 100\% ) \\ & \times ( 1 - \text{Diodes and connections} \div 100\% ) \\ & \times ( 1 - \text{DC wiring} \div 100\% ) \\ & \times ( 1 - \text{Tracking error} \div 100\% ) \\ & \times ( 1 - \text{Nameplate} \div 100\% ) \\ & \times ( 1 - \text{DC power optimizer loss} \div 100\% ) ] \} \end{aligned}$$

**Default DC Losses**

If you are not sure what values to use for the DC loss percentages, you can apply default losses appropriate for your system design.

**Important Note!** When you click one of the default loss buttons, SAM replaces the values of all six DC loss categories with the default values shown in the table below. After applying the default DC losses, you should change the tracking error and nameplate loss percentages as needed because those two losses are not affected by the type of inverter or presence of DC optimizers in the system.

**Central Inverters**

Each string in the array is connected to an inverter.

**Microinverters**

Each module is connected to its own [microinverter](#).

**DC optimizers**

Power electronics minimize array losses.

	Central inverters	Microinverters	DC optimizers
<b>Module mismatch</b>	2	0	0
<b>Diodes and connections</b>	0.5	0.5	0.5
<b>DC wiring</b>	2	2	2
<b>Tracking error</b>	0	0	0
<b>Nameplate</b>	0	0	0
<b>DC power optimizer loss</b>	0	0	1

**AC Losses**

The AC losses account for electrical wiring losses on the AC side of the system that the inverter model does not account for. During simulations, SAM uses the total AC loss to reduce the inverter AC electric output calculated by the inverter model.

**AC wiring**

Loss to account for electrical losses in AC wiring between the inverter and the grid connection point.

## Transformer Losses

Use transformer losses to calculate electrical losses in the output of the inverter from a distribution or substation transformer in a large photovoltaic system. SAM assumes that the transformer capacity is equal to the total inverter rated capacity from the [System Design page](#).

### Transformer no load loss

The transformer's rated no load loss, or constant loss caused by the magnetizing current in the transformer's core.

### Transformer load loss

The transformer's rated load loss, or losses in the transformer's primary and secondary coil wiring that vary with the inverter's electrical output.

## System Availability

System availability losses are reductions in the system's output due to operational requirements such as maintenance down time or other situations that prevent the system from operating as designed.

**Note.** To model curtailment, or forced outages or reduction in power output required by the grid operator, use the inputs on the [Grid Limits](#) page.

To edit the system availability losses, click **Edit losses**.

The [Edit Losses](#) window allows you to define loss factors as follows:

- Constant loss is a single loss factor that applies to the system's entire output. You can use this to model an availability factor.
- Hourly losses apply to specific hours of the year.

SAM reduces the system's output in each hour by the loss percentage that you specify for that hour. For a given hour, a loss of zero would result in no adjustment. A loss of 5% would reduce the output by 5%, and a loss of -5% would increase the output value by 5%. For subhourly simulations, SAM applies the loss factor for a given hour to each time step in that hour

## 8.6.6 Results

You can find the Detailed Photovoltaic model time series results on the [Results](#) page after running a simulation. SAM displays time series data under Lifetime and Hourly (or n-minute) headings, depending on the simulation time step.

- The Lifetime results are outputs of the performance model simulation, which runs over the analysis period from the Financial Parameters page.
- The Hourly (or n-minute) Data results are for weather file records and other inputs that are for a single year. The Detailed Photovoltaic model uses the same weather data for each year of the lifetime simulation.

The time series results are available on the following tabs of the Results page:

- [Data tables](#)
- [Time series](#)

- [Profiles](#)
- [Statistics](#)
- [Heat map](#)
- [PDF/CDF](#)

SAM also reports monthly and annual totals of some of the time series values under the headings **Single Values**, **Monthly Data**, and **Annual Data**.

## Photovoltaic System Results

### Hourly (or n-minute) Data

Variable Name	Units	Description
Absolute air mass		The optical length of the atmosphere at sea level, empirically corrected for atmospheric pressure to account for elevation and weather effects.
Irradiance DHI calculated		The diffuse horizontal irradiance that SAM calculates from the DNI and GHI in the weather file when you choose Direct normal and global horizontal on the <a href="#">Location and Resource</a> page, or from the POA irradiance data in the weather file when you choose one of the POA options on the Location and Resource page. If the weather file also contains DHI data, SAM uses the calculated DHI to calculate POA irradiance.
Irradiance DHI from weather file	W/m <sup>2</sup>	The diffuse horizontal radiation value from the weather file. "NaN" indicates that the weather file does not contain DHI data.
Irradiance DNI calculated		The direct normal irradiance value that SAM calculates from the GHI and DHI from the weather file when you choose Global horizontal and diffuse horizontal on the <a href="#">Location and Resource</a> page, or from the POA irradiance data in the weather file when you choose one of the POA options on the Location and Resource page. If the weather file also contains DNI data, SAM uses the calculated DNI to calculate POA irradiance.
Irradiance DNI from weather file	W/m <sup>2</sup>	The direct normal radiation value from the weather file. "NaN" indicates that the weather file does not contain DNI data.
Irradiance GHI calculated	W/m <sup>2</sup>	Global horizontal irradiance that SAM calculates from the DNI and DHI irradiance in the weather file when you choose Direct normal and diffuse horizontal on the <a href="#">Location and Resource</a> page. If the weather file also contains GHI data, SAM uses the calculated GHI to calculate the POA irradiance.
Irradiance GHI from weather file	W/m <sup>2</sup>	Global horizontal irradiance from weather file. "NaN" indicates that the weather file does not contain GHI data.
Irradiance POA from weather file	W/m <sup>2</sup>	Plane-of-array total irradiance from the weather file. "NaN" indicates that the weather file does not contain POA irradiance data.

Sun altitude angle	deg	Altitude angle of the sun either at the midpoint of the hour, or for a weather file with minute data, at the minute indicated for the time step.
Sun azimuth angle	deg	Azimuth angle of the sun either at the midpoint of the hour, or for a weather file with minute data, at the minute indicated for the time step.
Sun position calculation time	hour	The hour of day for the sun angles in the current time step.
Sun up over horizon		A flag value indicating the sun's position relative to the horizon: 0=below horizon, 1=above horizon, 2=rising, 3=setting. SAM uses the flag in internal calculations to determine what calculations to make during the simulation.
Sun zenith angle	deg	Zenith angle of the sun either at the midpoint of the hour, or for a weather file with minute data, at the minute indicated for the time step.
TOD factors		PPA price multipliers from Total loss from <a href="#">Time of Delivery Factors</a> page.
Weather file albedo		The albedo (ground reflectance) value, either from the weather file, or from the input value on the <a href="#">System Design</a> page, depending on whether Use albedo in weather file if it is specified is checked.
Weather file ambient temperature	°C	Ambient temperature from the weather file (dry-bulb temperature).
Weather file snow depth	cm	Depth of snow from the weather file.
Weather file wind speed	m/s	Wind speed from weather file.

## Lifetime Data

Variable Name	Units	Description
Absolute air mass		The optical length of the atmosphere at sea level, empirically corrected for atmospheric pressure to account for elevation and weather effects.
AC wiring loss		AC loss calculated from the AC wiring loss percentage on the <a href="#">Losses</a> page and applied to calculate the inverter AC output power.
Array POA beam radiation after shading and soiling	kW	The beam radiation incident on the entire array after soiling, shading, and snow losses are applied for all subarrays, expressed in kilowatts.
Array POA beam radiation nominal	kW	The beam radiation incident on the entire array before shading and soiling factors are applied.
Array POA total radiation after shading and soiling	kW	The total radiation incident on the entire array after shading, soiling, and snow losses for all subarrays expressed in kilowatts. This is the solar energy available to the array for conversion to electricity.
Array POA total radiation after shading only	kW	Total radiation incident on the entire array after shading factors are applied, but before soiling factors are applied.
Array POA total radiation nominal	kW	Total radiation incident on the entire array before shading and soiling factors are applied for all subarrays expressed in kilowatts.

Inverter clipping loss AC power limit	kW	Inverter output in excess of the inverter's rated output. During hours with clipping losses, the inverter's AC output in kW should be equal to the inverter's rated capacity in kW.
Inverter clipping loss DC MPPT voltage limits	kW	Reduction in output caused by the array DC voltage falling outside of the inverter minimum or maximum MPPT voltage ratings.
Inverter DC input power	kW	The DC power at the inverter input.
Inverter DC input voltage	V	The DC voltage at the inverter input. This is either the average of the subarray voltages, or calculated using the PV subarray voltage mismatch algorithm if the option is checked on the <a href="#">System Design</a> page.
Inverter efficiency	%	The inverter DC-to-AC conversion efficiency.
Inverter night time loss	kW	Inverter's AC electricity consumption at night when the array's output is zero, equal to the value from the <a href="#">Inverter</a> page.
Inverter power consumption loss	kW	Inverter's electricity consumption during all hours, calculated based on the value from the <a href="#">Inverter</a> page. SAM does not calculate this value with the Inverter Datasheet model with weighted efficiency, or with the Inverter Part Load model because the loss is assumed to be included in the weighted efficiency values.
Irradiance DHI calculated		The diffuse horizontal irradiance that SAM calculates from the DNI and GHI in the weather file when you choose Direct normal and global horizontal on the <a href="#">Location and Resource</a> page, or from the POA irradiance data in the weather file when you choose one of the POA options on the Location and Resource page. If the weather file also contains DHI data, SAM uses the calculated DHI to calculate POA irradiance.
Irradiance DHI from weather file	W/m <sup>2</sup>	The diffuse horizontal radiation value from the weather file. "NaN" indicates that the weather file does not contain DHI data.
Irradiance DNI calculated		The direct normal irradiance value that SAM calculates from the GHI and DHI from the weather file when you choose Global horizontal and diffuse horizontal on the <a href="#">Location and Resource</a> page, or from the POA irradiance data in the weather file when you choose one of the POA options on the Location and Resource page. If the weather file also contains DNI data, SAM uses the calculated DNI to calculate POA irradiance.
Irradiance DNI from weather file	W/m <sup>2</sup>	The direct normal radiation value from the weather file. "NaN" indicates that the weather file does not contain DNI data.
Irradiance GHI calculated	W/m <sup>2</sup>	Global horizontal irradiance that SAM calculates from the DNI and DHI irradiance in the weather file when you choose Direct normal and diffuse horizontal on the <a href="#">Location and Resource</a> page. If the weather file also contains GHI data, SAM uses the calculated GHI to calculate the POA irradiance.



Irradiance GHI from weather file	W/m <sup>2</sup>	Global horizontal irradiance from weather file. "NaN" indicates that the weather file does not contain GHI data.
Irradiance POA from weather file	W/m <sup>2</sup>	Plane-of-array total irradiance from the weather file. "NaN" indicates that the weather file does not contain POA irradiance data.
Subarray 1..4 Angle of incidence	deg	Solar angle of incidence on the photovoltaic array either at the midpoint of the hour, or for a weather file with minute data, at the minute indicated for the time step.
Subarray 1..4 Axis rotation for 1 axis trackers	deg	For 1-axis tracking, tracker's actual axis rotation angle for this subarray. See ideal axis rotation below.
Subarray 1..4 axis rotation ideal for 1 axis trackers (deg)	deg	For one-axis tracking, the value of this subarray angle of rotation that minimizes its incidence angle with the sun. When backtracking is enabled for one-axis trackers, the actual axis rotation angle is different from the ideal rotation during morning and afternoon hours to avoid shading. The difference between the ideal axis rotation and the axis rotation is the rotation adjustment due to backtracking.
Subarray 1..4 Cell temperature	C	Temperature of module cells in this subarray.
Subarray 1..4 External shading and soiling beam irradiance factor	frac	The shading factor for this subarray that applies to the current time step. The beam shading factor is converted from the percentage beam shading loss specified in the shading loss tables. A value of 0 means no shading. A value of 1 means the beam irradiance incident on the subarray is completely blocked.
Subarray 1..4 Module efficiency	%	Module conversion efficiency.
Subarray 1..4 Open circuit voltage	V	String open circuit voltage for this subarray. Shown for reference.
Subarray 1..4 Operating voltage	V	String operating voltage for this subarray. Used to ensure array voltage is within inverter input voltage limits.
Subarray 1..4 POA beam irradiance after shading and soiling	W/m <sup>2</sup>	Direct normal radiation incident on this subarray after soiling factor.
Subarray 1..4 POA diffuse irradiance after shading and soiling	W/m <sup>2</sup>	Diffuse radiation incident on this subarray after soiling factor.
Subarray 1..4 POA total irradiance after shading and soiling	W/m <sup>2</sup>	Total radiation incident on this subarray. (Sum of incident beam and incident diffuse.)
Subarray 1..4 POA total irradiance after shading only	W/m <sup>2</sup>	Total radiation incident on this subarray after shading factors but before soiling factors are applied.
Subarray 1..4 POA total irradiance nominal	W/m <sup>2</sup>	Total irradiance incident on this subarray before shading, soiling, or snow losses.
Subarray 1..4 Self-shading non-linear DC factor		Factor applied to the subarray's DC electrical output by the non-linear self-shading model to account for the reduction in incident beam irradiance on the subarray..
Subarray 1..4 Self-shading non-linear ground diffuse irradiance factor		Factor applied to the subarray's plane-of-array diffuse irradiance by the non-linear self-shading model to account for the reduction in incident ground-reflected diffuse irradiance.
Subarray 1..4 Self-shading non-linear sky diffuse irradiance factor		Factor applied to the subarray's plane-of-array diffuse irradiance by the non-linear self-shading model to account for the reduction in incident diffuse irradiance from the sky.

Subarray 1..4 snow cover DC power loss	kW	Reduction in the subarray's DC electrical output caused by snow covering the array.
Subarray 1..4 Soiling beam irradiance factor	frac	Factor applied to the incident beam irradiance to account for soiling of modules in the subarray, determined by the soiling losses from the <a href="#">Losses</a> page..
Subarray 1..4 Surface azimuth	deg	Angle of the array from due north for this subarray.
Subarray 1..4 Surface tilt	deg	Angle of the array from the horizontal for this subarray.
Sun altitude angle	deg	Altitude angle of the sun either at the midpoint of the hour, or for a weather file with minute data, at the minute indicated for the time step.
Sun azimuth angle	deg	Azimuth angle of the sun either at the midpoint of the hour, or for a weather file with minute data, at the minute indicated for the time step.
Sun position calculation time	hour	The hour of day for the sun angles in the current time step.
Sun up over horizon		A flag value indicating the sun's position relative to the horizon: 0=below horizon, 1=above horizon, 2=rising, 3=setting. SAM uses the flag in internal calculations to determine what calculations to make during the simulation.
Sun zenith angle	deg	Zenith angle of the sun either at the midpoint of the hour, or for a weather file with minute data, at the minute indicated for the time step.
System power generated	kW	AC power at the grid interconnection point. A negative value indicates the system is using grid power for inverter night-time consumption (or to charge the battery).
Transformer load loss	kW	Distribution or substation transformer constant loss, typically mostly from the magnetizing current in the transformer's core.
Transformer no load loss	kW	Distribution or substation transformer variable loss, typically mostly from the transformer's primary and secondary coil wiring.
Transformer total loss	kW	Total loss from the distribution or substation transformer.
Weather file albedo		The albedo (ground reflectance) value, either from the weather file, or from the input value on the <a href="#">System Design</a> page, depending on whether Use albedo in weather file if it is specified is checked.
Weather file ambient temperature	°C	Ambient temperature from the weather file (dry-bulb temperature).
Weather file snow depth	cm	Depth of snow from the weather file.
Weather file wind speed	m/s	Wind speed from weather file.

## 8.7 PVWatts

SAM's PVWatts model uses the same underlying code as NREL's online [PVWatts® Calculator](#). SAM has the following features that are not available in the online calculator:

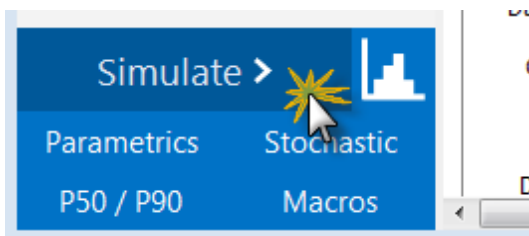
- You can choose a weather file on the [Location and Resource](#) page. The online calculator requires you to use weather data from an internal database.

- Optional grid interconnection and curtailment inputs on the [Grid Limits](#) page.
- You can use PVWatts with a [financial model](#) to calculate metrics like net present value, payback period, and levelized cost of energy.
- When you combine PVWatts with the Residential or Commercial financial model, you can include a [battery](#) in the system design.

For a detailed descriptions of the model, see publications listed under "PVWatts" on the [PV Publications](#) page of the SAM website.

### **Basic steps to run PVWatts:**

1. On the [Location and Resource](#) page, choose or download a weather file to represent the solar resource at the project location.
2. On the [System Design](#) page, enter the system's DC nameplate capacity for Nameplate Capacity.
3. Choose a tracking option and specify the tilt angle.
4. If you are using PVWatts with a financial model, on the PV System Costs page, specify the project costs and review the inputs on the Financial Parameters and Incentives pages.
5. For the Residential and Commercial financial models, review the inputs on the Electricity Rates and Electric Load input pages. These inputs are used for monthly electricity bill calculations and to account billing options such as net metering.
6. Run a simulation and review results on the [Results page](#) for details.



### **About PVWatts Versions**

SAM uses PVWatts Version 7. The online [PVWatts Calculator](#)<sup>®</sup> use PVWatts Version 5. Differences in results between SAM's implementation of PVWatts and the online calculator may be caused by different weather data or by the differences between these versions listed below.

The following table summarizes the PVWatts versions used by different applications. The SAM Simulation Core (SSC) is SAM's underlying software framework that is used by the SAM desktop application, the online PVWatts Calculator, [SAM Software Development Kit \(SDK\)](#), and the [PVWatts Web API](#) available from the NREL Developer Network.

<b>SAM Versions</b>	<b>PVWatts SSC Module Version</b>	<b>PVWatts Web API Version</b>
Newer than 2018.11.11	<i>pvwattsv7</i>	Not yet implemented*
2014.11.24 – 2018.11.11	<i>pvwattsv5</i>	PVWatts V5, V6 <sup>+</sup>
Older than 2014.11.24	<i>pvwattsv1</i>	PVWatts V4

\*As of January 2020, the online calculator uses the PVWatts V6 Web API, which runs *pvwattsv5*. The online calculator will be updated to use *pvwattsv7* when it is available via an API on the NREL Developer Network.

<sup>+</sup>The difference between PVWatts API Versions 5 and 6 is the weather database they access and the default value of the ground coverage ratio (GCR) input. Both run the *pvwattsv5* SSC module.

## Differences between PVWatts Version 5 and Version 7

The following list summarizes the features added to PVWatts Versions 7 (*pvwatts7*) since Version 5 (*pvwatts5*). For the default PVWatts - No Financial configuration in SAM, the total annual energy predicted by Version 7 is 2.8% higher than Version 5.

- Self-shading applies to the fixed open rack and 1-axis tracking array types and accounts for diffuse shading. In Version 5, self-shading only applies to 1-axis tracking.
- Diffuse shading applies to the 1-axis backtracking array type. In Version 5, it only applies to the 1-axis tracking array type.
- Account for incident angle reflection losses in the module cover using the [physical model](#) for incident angle modifier to account for reflection losses of both direct and beam irradiance.
- Update parameter values for module type (see table below).
- Apply air mass modifier to account for solar spectrum.
- Optional snow loss model, only available when weather file contains snow depth data.

The following features are available to programmers using the SAM Software Development Kit to access PVWatts Version 7. These features are adapted from SAM's Detailed Photovoltaic model's CEC Module model. They are not available either in SAM's implementation of PVWatts or the online calculator:

- Stow trackers when wind speed exceeds an upper limit (to avoid wind damage).
- Bifacial modules.
- Transformer losses.
- Soiling loss input as a beam irradiance loss.

The following table shows the differences in module type parameters between pvsamv5 and pvsamv7.

Module Type	Approximate Nominal Efficiency (%) V5 / V7	Module Cover V5 / V7	Temperature Coefficient of Power (%/°C) V5 / V7	Fill Factor (for self-shading) V5 / V7
Standard (crystalline Silicon)	15 / 17	Glass / Anti-reflective	-0.47 / -0.37	None / 77.1%
Premium (crystalline Silicon)	19 / 20.1	Anti-reflective	-0.35 / -0.35	None / 80.1%
Thin film	10 / 15.6	Glass / Anti-reflective	-0.20 / -0.32	None / 70.6%

### 8.7.1 System Design

The inputs on the System Design page describe the physical characteristics of the photovoltaic system. You only need to provide basic information about the system. PVWatts makes assumptions about modules, inverter, and other parts of the system so you do not need to provide detailed information about those parts of the system.

**Note.** SAM uses PVWatts Version 7, which is different from the online [PVWatts@ Calculator](#). SAM's results will likely be different from the online calculator's results until the online calculator is updated. See [About PVWatts Versions](#) for more information.

## System Parameters

The system inputs define the size of the system, [losses](#), and the array orientation.

### System nameplate capacity, kWdc

The DC system capacity is the DC (direct current) power rating of the photovoltaic array in kilowatts (kW) at standard test conditions (STC). PVWatts can model any size of array, from residential rooftop systems to large ground-mounted power generation systems.

### Module type

The type of modules in the system. If you do not have information about the modules in the system, use the default standard module type.

Module Type	Approximate Nominal Efficiency	Module Cover	Temperature Coefficient of Power	Fill Factor (for self-shading)
Standard (crystalline Silicon)	17%	Glass	-0.47 %/°C	77.1%
Premium (crystalline Silicon)	20.1	Anti-reflective	-0.35 %/°C	80.1%
Thin film	15.6	Glass	-0.20 %/°C	70.6%

PVWatts uses a basic set of equations to represent the module's physical properties and performance. The module type determines how PVWatts calculates the angle-of-incidence correction factor as sunlight passes through the module cover to the photovoltaic cell, and the cell's operating temperature.

### DC to AC ratio

The DC to AC size ratio is the ratio of the inverter's AC rated size to the array's DC rated size. Increasing the ratio increases the system's output over the year, but also increases the array's cost. The default value is 1.10, which means that a 4 kW system size would be for an array with a 4 DC kW nameplate size at standard test conditions (STC) and an inverter with a 3.63 AC kW nameplate size.

For a system with a high DC to AC size ratio, during times when the array's DC power output exceeds the inverter's rated DC input size, the inverter limits the array's power output by increasing the DC operating voltage, which moves the array's operating point down its current-voltage (I-V) curve. PVWatts models this effect by limiting the inverter's power output to its rated AC size.

The default value of 1.10 is reasonable for most systems. A typical range is 1.10 to 1.25, although some large-scale systems have ratios of as high as 1.50. The optimal value depends on the system's location, array orientation, and module cost.

### Inverter efficiency

The inverter's nominal rated DC-to-AC conversion efficiency, defined as the inverter's rated AC power in kilowatts divided by its rated DC power in kilowatts expressed as a percentage. The default value is 96%.

PVWatts calculates the inverter's hourly operating efficiency based on the nominal efficiency and an

efficiency curve.

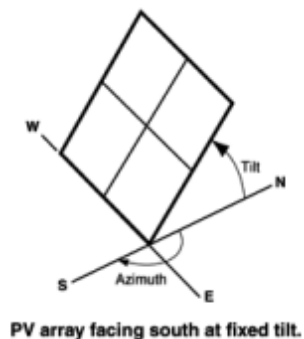
## Orientation

### Array type

The array type describes whether the PV modules in the array are fixed, or whether they move to track the movement of the sun across the sky with one or two axes of rotation. The default value is for a fixed array with no tracking.

### Fixed open rack and roof mount

The array is fixed at the tilt and azimuth angles defined by the values of **Tilt** and **Azimuth** and does not follow the sun's movement.



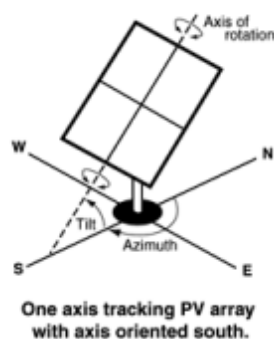
For systems with fixed arrays, you can choose between an open rack or a roof mount.

**Fixed open rack** is appropriate for ground-mounted systems. The open rack option assumes that air flows freely around the array, helping to cool the modules and reduce cell operating temperatures. (The array's output increases as the cell temperature decreases for at a given incident solar irradiance.) The open rack option also assumes that modules are arranged in rows and uses the ground coverage ratio (GCR) to estimate irradiance losses due to self shading caused when modules in neighboring rows cause shadows on the array.

**Fixed roof mount** is typical of residential installations where modules are attached to the roof surface with standoffs that providing limited air flow between the module back and roof surface (typically between two and six inches). The roof mount option assumes that there is no self shading between modules.

### 1-axis tracking and 1-axis backtracking

The array is fixed at the angle from the horizontal defined by the value of **Tilt** and rotates about the tilted axis from east in the morning to west in the evening to track the daily movement of the sun across the sky. **Azimuth** determines the array's orientation with respect to a line perpendicular to the equator.

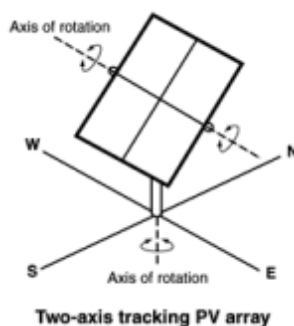


For **1-axis tracking**, PVWatts models self shading based on the ground coverage ratio (GCR).

For **1-axis backtracking**, PVWatts assumes that there is no self shading because the trackers rotate modules to avoid it. Backtracking is a tracking algorithm that rotates the array toward the horizontal during early morning and late evening hours to reduce the effect of self shading. The one-axis tracking algorithm assumes a rotation limit of  $\pm 45$  degrees from the horizontal.

### 2-axis tracking

The array rotates from east in the morning to west in the evening to track the daily movement of the sun across the sky, and north-south to track the sun's seasonal movement throughout the year. For two-axis tracking, SAM ignores the values of **Tilt** and **Azimuth**.



PVWatts does not model self shading for 2-axis tracking. You can adjust the [Losses](#) to account for those losses.

### Tilt, degrees

The array's tilt angle in degrees from horizontal, where zero degrees is horizontal, and 90 degrees is vertical and facing the equator (in both the southern and northern hemispheres).

As a rule of thumb, system designers sometimes use the location's latitude (shown on the [Location and Resource](#) page) as the optimal array tilt angle. The actual tilt angle will vary based on project requirements.

### Azimuth, degrees

The array's east-west orientation in degrees. An azimuth value of zero is facing north, 90 degrees = east, 180 degrees = south, and 270 degrees = west, regardless of whether the array is in the northern or southern hemisphere.

For systems north of the equator, a typical azimuth value would be 180 degrees. For systems south of the equator, a typical value would be 0 degrees.

The azimuth angle does not apply to arrays with 2-axis tracking.

### Ground coverage ratio (GCR)

The ratio of the photovoltaic array area to the total ground area. PVWatts uses the GCR to estimate self-shading losses for the fixed open rack and 1-axis array types, and to determine when to backtrack for the 1-axis backtracking option. The GCR does not apply to the fixed open rack and 2-axis tracking array types.

For an array configured in rows of modules, the GCR is the length of the side of one row divided by the distance between the bottom of one row and the bottom of its neighboring row. An array with a low ground coverage ratio (closer to zero) has rows spaced further apart than an array with a high ground coverage ratio (closer to 1).

The ground coverage ratio must be a value greater than 0.01 and less than 0.99.

## Losses

Losses account for reduction in performance not explicitly calculated by the PVWatts model. SAM applies the total system losses to the AC power output calculated by the model. You can either enter a total loss value, or have SAM calculate the total loss value from the loss categories.

### Specify total system loss

Check this option if you want to specify a single loss value instead of values for each of the categories listed below.

### Soiling

Losses due to dust, dirt, and other foreign matter on the surface of the PV module that prevent solar radiation from reaching the cells. Soiling is location- and weather-dependent. There are greater soiling losses in high-traffic, high-pollution areas with infrequent rain.

### Shading

Reduction in the incident solar radiation caused by hills, trees, or other objects on the horizon. The default value is 3%. Note that PVWatts accounts for self shading between rows of modules for the fixed open rack and 1-axis tracking array types, so you should not include self-shading in the shading loss for those options.

### Snow

Reduction in the system's annual output due to snow covering the array. The default value is zero, assuming either that there is never snow on the array, or that the array is kept clear of snow.

**Note.** If your weather file includes snow depth data and you enable the snow model, you should set the Snow loss to zero.

### Mismatch

Electrical losses due to slight differences caused by manufacturing imperfections between modules in the array that cause the modules to have slightly different current-voltage characteristics. The default value of is 2%.

### Wiring

Resistive losses in the DC and AC wires connecting modules, inverters, and other parts of the system. The default value is 2%.



**Connections**

Resistive losses in electrical connectors in the system. The default value is 0.5%.

**Light-Induced Degradation**

Effect of the reduction in the array's power during the first few months of its operation caused by light-induced degradation of photovoltaic cells. The default value is 1.5%.

**Nameplate Rating**

The nameplate rating loss accounts for the accuracy of the manufacturer's nameplate rating. Field measurements of the electrical characteristics of photovoltaic modules in the array may show that they differ from their nameplate rating. A nameplate rating loss of 5% indicates that testing yielded power measurements at STC that were 5% less than the manufacturer's nameplate rating. The default value is 1%.

**Age**

Effect of weathering of the photovoltaic modules on the array's performance over time. The default value is zero.

**Note.** If you specify a degradation rate on the [Lifetime and Degradation](#) page to represent module degradation, you should set the Age loss to zero.

**Availability**

Reduction in the system's output cause by scheduled and unscheduled system shutdown for maintenance, grid outages, and other operational factors. The default value is 3%.

**Note.** If you specify [system availability losses](#) to represent operating losses, you should set the Availability loss to zero.

**Total system losses**

The total loss, either calculated from the loss categories listed above, or equal to the total system loss you specify.

$$\begin{aligned}
 \text{Total system losses} = & 100\% \times \{ 1 - [ ( 1 - \text{Soiling} \div 100\% ) \\
 & \times ( 1 - \text{Shading} \div 100\% ) \\
 & \times ( 1 - \text{Snow} \div 100\% ) \\
 & \times ( 1 - \text{Mismatch} \div 100\% ) \\
 & \times ( 1 - \text{Wiring} \div 100\% ) \\
 & \times ( 1 - \text{Connections} \div 100\% ) \\
 & \times ( 1 - \text{Light-induced degradation} \div 100\% ) \\
 & \times ( 1 - \text{Nameplate} \div 100\% ) \\
 & \times ( 1 - \text{Age} \div 100\% ) \\
 & \times ( 1 - \text{Availability} \div 100\% ) ] \}
 \end{aligned}$$

**Shading and Snow**

The shading losses represent a reduction of the incident solar irradiance due to external shading of the array caused by nearby objects such as trees and buildings. You can specify hourly beam shading losses and a single sky diffuse shading loss or import shading loss data from shade analysis tools or calculators in the Edit Shading window.

**Shading**

The time series [results](#) show the effect of external shading: SAM displays the shading factor for beam radiation and the plane-of-array (POA) irradiance. The beam and diffuse shading losses that you specify both reduce the POA irradiance.

## Enabling and Disabling Shading

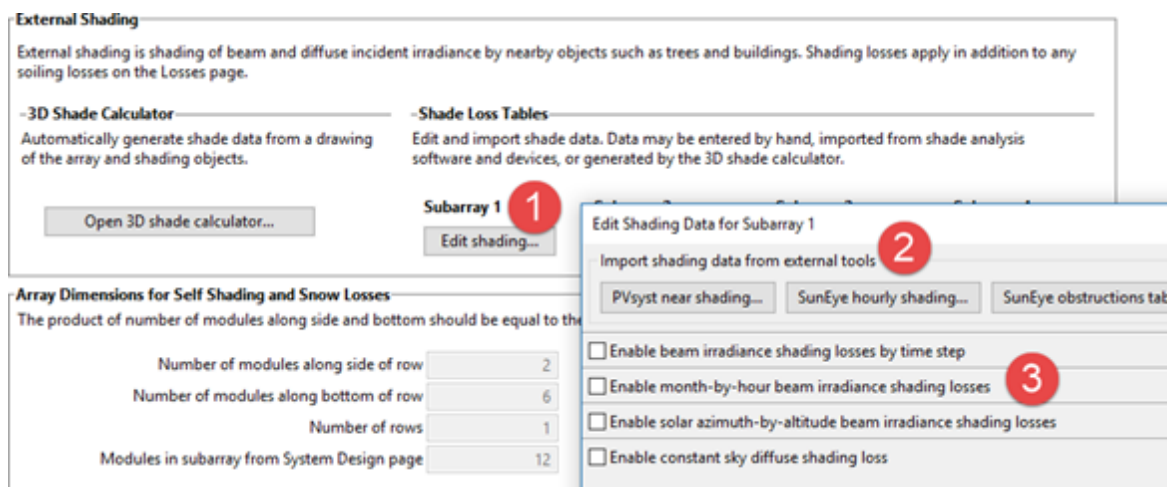
SAM offers several options for specifying shading losses.

- You must choose at least one option.
- SAM does not prevent you from enabling more than one option even if that results in an unrealistic shading model. Be sure to verify that you have enabled the set of options you intend before running a simulation.

### To enable the external shading:

1. Click **Edit Shading**.
2. If you are working with a shading file from PVsyst, Solmetric Suneye, or Solar Pathfinder software, in the Edit Shading window, click the appropriate button under **Import shading data from external tools** to import the file.
3. If you are using a table to specify shading factors (you can type, import, or paste values into the table), check the appropriate **Enable** box in the Edit Shading window.

**Note.** For detailed instructions on specifying shading losses, click **Help** in the Edit Shading Data window.



**Note.** If you use specify beam and diffuse shading losses, be sure to set the Shading loss under [Losses](#) to zero.

## Snow

For a description of the snow model, see the following publications available along with other technical documentation from the [SAM website](#):

- Gilman, P.; Dobos, A.; DiOrio, N.; Freeman, J.; Janzou, S.; Ryberg, D. (2018) SAM Photovoltaic Model Technical Reference Update. 93 pp.; NREL/TP-6A20-67399

- Ryberg, D.; Freeman, J. (2017). Integration, Validation and Application of a PV Snow Coverage Model in SAM. National Renewable Energy Laboratory. 33 pp. TP-6A20-68705 available along with other technical documentation from the [SAM website](#).

Use the following output variables to explore the effect of snow cover (see [Results](#) for descriptions of the variables):

- **Array DC power loss due to snow (kW)**
- **Weather file snow depth file (cm)**

**Note.** Snow depth data is not available in the NSRDB PSM V3 dataset. It is available in the [NSRDB 1961 - 1990 Archive Data](#). This older data does not represent the best up-to-date data from the NSRDB, but may be useful for testing SAM's snow loss model.

The Ryberg (2017) paper cited above includes a United States map of annual average snow loss values that could be used to estimate snow loss using inputs on the Losses page instead of the snow model when snow depth data is not available.

SAM's snow model for photovoltaic systems estimates the loss in system output during time steps when the array is covered in snow. It uses snow depth data from the weather file, and for time steps with snow, estimates the percentage of the photovoltaic array that is covered with snow based on the array's tilt angle, plane-of-array irradiance, and ambient temperature. The model assumes that the array is completely covered with snow when the snow depth data indicates a snowfall, and that snow slides off the array as the ambient temperature increases.

#### **Estimate snow losses**

Check this option to model snow losses if the weather file on the [Location and Resource](#) page includes snow depth data.

#### ▼ **System Availability**

System availability losses are reductions in the system's output due to operational requirements such as maintenance down time or other situations that prevent the system from operating as designed.

**Note.** To model curtailment, or forced outages or reduction in power output required by the grid operator, use the inputs on the [Grid Limits](#) page.

To edit the system availability losses, click **Edit losses**.

The [Edit Losses](#) window allows you to define loss factors as follows:

- Constant loss is a single loss factor that applies to the system's entire output. You can use this to model an availability factor.
- Hourly losses apply to specific hours of the year.

SAM reduces the system's output in each hour by the loss percentage that you specify for that hour. For a given hour, a loss of zero would result in no adjustment. A loss of 5% would reduce the output by 5%, and a loss of -5% would increase the output value by 5%. For subhourly simulations, SAM applies the loss factor for a given hour to each time step in that hour

## Battery Bank

The PVWatts battery model is for a battery bank connected to the system on the AC side of the inverter, and designed to reduce a residential or commercial building's electricity bill by minimizing grid power consumption. The battery model is only available for the PVWatts model with the Residential, Commercial, or Third Party financial models. It requires that you define a [building's electric load](#).

**Note.** To model a battery bank for a photovoltaic system with one of the PPA financial models, or for battery model with more features, use the [detailed photovoltaic model](#). The PVWatts battery model is a simplified version of the [detailed photovoltaic battery model](#).

### Enable battery

Check the box to include a battery in the system. Clear the box to model a photovoltaic system with no battery.

### Battery capacity, kWh

The size of the battery bank in kilowatt-hours.

### Battery power, kW

The battery bank's maximum power output in kilowatts.

### Battery chemistry

The type of battery. The PVWatts battery model can model lead acid (VRLA) and Lithium-ion (NMC) batteries. For more battery chemistry options, use the [detailed photovoltaic model](#) instead of the PVWatts model.

### Battery dispatch

- Choose **Peak Shaving (look ahead)** to discharge the battery each day based on the next day's hour of peak grid consumption, determined from next day's load and generation profile.
- Choose **Peak Shaving (look behind)** to dispatch the battery each day based on the previous day's hour of peak grid consumption.
- Choose **Custom Dispatch** to input a time series array indicating how to charge or discharge the battery. See below for details

## Custom Dispatch

When you choose **Custom Dispatch**, click **Edit data** to open the [Edit Array](#) window and specify a charge or discharge power value for each simulation time step: To discharge in a given time step, use a positive value in kW; to charge in a given time step, use a negative kW value.

## Optimal Sizing and Dispatch from REopt

The "Get Size and Dispatch" option sends information from your case in SAM to NREL's REopt Web API to automatically size the battery and determine a dispatch schedule.

### To automatically size and dispatch the battery:

- Click Get size and dispatch and wait for SAM to interact with the ReOpt API.

## 8.7.2 Results

The PVWatts performance model displays the following results in [Tables](#) and [Time Series](#) graphs. For details about how the model calculates these results, see Dobos, A. (2014). PVWatts Version 5 Manual ([PDF 714 KB](#)).

### Hourly Data

Variable Name	Units	Description
AC inverter power	W	The output power of the inverter(s)
Ambient temperature	°C	Ambient temperature (dry-bulb) from the weather file
Angle of incidence	degrees	The angle between the beam irradiance and a line normal to the photovoltaic array surface.
Beam irradiance	W/m <sup>2</sup>	Direct normal solar irradiance data from the weather file
DC array power	W	The output power of the photovoltaic array
Diffuse irradiance	W/m <sup>2</sup>	Diffuse horizontal solar irradiance data from the weather file
Global horizontal irradiance	W/m <sup>2</sup>	Global horizontal solar irradiance data from the weather file
Module temperature	°C	Operating temperature of the photovoltaic cells in the modules
Plane of array irradiance	W/m <sup>2</sup>	Solar irradiance incident on the photovoltaic array
Power generated by system	kW	The output power of the system (equal to the AC inverter power converted from W to kW)
Shading factor for beam radiation	-	Factor applied to beam irradiance to represent reduction due to shading
Sun up over horizon	-	Indicates whether the sun is up for the given time step (1 = sun over horizon, 0 = sun below horizon)
Transmitted plane of array irradiance	W/m <sup>2</sup>	Plane of array irradiance transmitted through the module cover to the photovoltaic cells
Wind speed	m/s	Wind speed data from the weather file

### Monthly Data

Variable Name	Units	Description
DC Output	kWh	Monthly total of hourly array DC output values.
Monthly Energy	kWh	Monthly total of hourly energy values.
Monthly Energy Delivered	kWh	Monthly total of hourly energy delivered values.

## 8.8 Concentrating Photovoltaic

The high concentration photovoltaic (HCPV) model represents a HCPV system as an array of modules with one or more inverters as specified on the Array page. SAM models the HCPV module using a cell efficiency curve and a set of loss factors that you specify on the Module page. The multi-junction cell's efficiency curve is a linear interpolation of the table of power conversion efficiencies as a function of incident beam irradiance (direct normal irradiance, or DNI) that you specify. The model uses an air mass modifier polynomial to

approximate spectral effects on the performance of the module. You can also specify loss factors to account for optical lens, alignment error, tracker error, wind flutter, and other CPV-specific losses. The HCPV uses SAM's Sandia inverter model.

## Basic Steps

### 1. On the Location and Resource page, choose a weather file to represent the solar resource at the project location

SAM offers three weather data options. You can:

- Choose a location from the list at or near your project site. SAM will simulate the system using a file from SAM's solar resource library, which includes data from the National Solar Radiation DatabaseNREL's TMY2 database.
- Download a weather file for your site from an online database. SAM will simulate the system using a file from NREL's database of satellite-derived solar resource data.
- Download a file from NREL's TMY3 database.
- Create a weather file in TMY3 format with your own data

For preliminary analyses in the United States either use a TMY2 file if there is a file in the database with similar weather to the project site, or download a file for the location.

For more robust analysis, download TMY3 data, or use your own data. You may also want to analyze your project using weather data from different sources to develop an understanding of how uncertainty in the weather data affects the metrics of interest for your project.

### 4. Specify the system's characteristics

1. On the [Inverter](#) page, choose an inverter.
2. On the [Module](#) page, specify the CPV module parameters.
3. On the [Array](#) page, specify the system's size and other parameters.

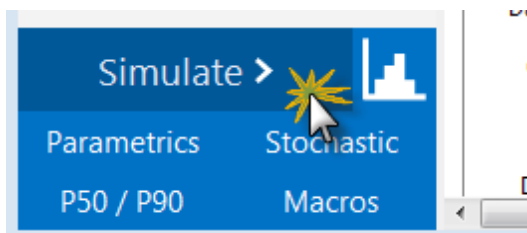
### 5. On the PV System Costs page, specify the project costs

The capital costs (direct and indirect) are construction and installation costs that SAM applies to year zero of the cash flow.

The operation and maintenance costs apply in years one and later of the cash flow.

See [PV System Costs](#) for details.

### 6. Run a simulation and review results



See [Results Page](#) for details.

## 8.8.1 Module

The HCPV Module page inputs are for the high concentration photovoltaic performance model.

### High Concentration Photovoltaic (HCPV) Module

#### Single cell area, cm<sup>2</sup>

The area in square centimeters of one cell in the module.

#### Number of cells

The number of cells in a single module.

#### Concentration ratio

The ratio of lens area to cell area. SAM uses this value to calculate the Overall Module Area based on the Single Cell Area and Number of Cells that you specify.

#### Optical error factor

SAM applies this factor to the plane-of-array beam irradiance to adjust the value to account for losses due to lens optical error.

#### Alignment loss factor

SAM applies this factor to the plane-of-array beam irradiance to adjust the value to account for losses due to alignment error.

#### Wind flutter loss factor (per m/s)

SAM uses this factor to reduce the cell power value based on the wind speed to account for losses due to motion of the module caused by the wind. For each time step in the simulation, SAM reduces the calculated cell output power by  $1 - \text{Flutter Loss Factor} \times \text{Wind Speed}$ .

#### Maximum Power (Pmp), Wdc

The module's maximum power point rating in DC Watts.

$$\begin{aligned} \text{Maximum Power (Wdc)} &= \text{Reference Cell Efficiency (\%)} \div 100 \\ &\times \text{Reference POA Irradiance (W/m}^2\text{)} \\ &\times \text{Overall Module Area (m}^2\text{)} \\ &\times \text{Optical Error Factor} \\ &\times (1 - \text{Wind Flutter Loss Factor} \times 4 \text{ m/s}) \\ &\times \text{Alignment Loss Factor} \\ &\times \text{Modifier at AM 1.5} \end{aligned}$$

#### Overall module area, m<sup>2</sup>

The module's reflective area in square meters.

$$\text{Overall Module Area (m}^2\text{)} = \text{Concentration Ratio} \times \text{Single Cell Area (cm}^2\text{)} \times 0.0001 \text{ (m}^2\text{/cm}^2\text{)} \times \text{Number of Cells}$$

#### Estimated reference module efficiency, %

The module's nominal efficiency.

$$\begin{aligned} \text{Estimated Module Efficiency (\%)} &= \text{Reference Cell Efficiency (\%)} \\ &\times \text{Optical Error Factor} \\ &\times (1 - \text{Wind Flutter Loss Factor} \times 4 \text{ m/s}) \end{aligned}$$

- x Alignment Loss Factor*
- x Modifier at AM 1.5*

## Spectral Effects

As you enter air mass modifier coefficients, SAM displays the air mass modifier values as a function of solar zenith angle in the graph that SAM will use during the simulation.

### Air mass modifier coefficients (a0 - a4)

Air mass coefficients.

### Modifier at AM 1.5

Reference air mass coefficient at 1.5 Air Mass.

$$\text{Modifier at AM 1.5} = a_0 + a_1 \times 1.5 + a_2 \times 2.25 + a_3 \times 5.0625 + a_4 \times 7.59375$$

### Reset to AM Defaults

Replaces the a0 - a4 coefficient values with default value.

## Multi-Junction Cell Efficiency

The cell efficiency table defines the cell's efficiency curve. Specify the cell efficiency at each of up to five plane-of-array (POA) beam irradiance values, and specify the reference value for capacity calculations.

SAM uses the reference value to determine the module capacity used in capacity-related cost calculations and to calculate the system's capacity factor.

During the simulation, SAM uses linear interpolation to estimate efficiency values between the points that you specify. For example, given POA Irradiance and cell efficiency values of 34% at 400 W/m<sup>2</sup> and 36% 600 W/m<sup>2</sup>, for an hour when the plane-of-array incident radiation value is 432 W/m<sup>2</sup>, SAM would estimate the cell efficiency at 34.32%.

**Note.** Be sure that the POA irradiance values increase monotonically from top to bottom.

### POA Irradiance (W/m<sup>2</sup>, Beam Normal)

The beam (direct normal) radiation in the plane of the array (POA).

### Concentrated (Suns)

The POA Irradiance value expressed in Suns, given the concentration ratio you specify.

$$\text{Concentrated (Suns)} = \text{Concentration Ratio} \times \text{POA Irradiance (W/m}^2) \div 1000 \text{ (W/m}^2 / \text{Sun)}$$

### MJ cell efficiency (%)

The multi-junction (MJ) cell efficiency at the given POA irradiance value.

### Reference

The reference POA irradiance and cell efficiency values for nameplate capacity calculations.



## 8.8.2 Inverter

The Sandia Performance Model for Grid-Connected PV Inverters is an empirically-based performance model that uses parameters from a database of commercially available inverters maintained by Sandia National Laboratory. The parameters are based on manufacturer specifications and laboratory measurements for a range of inverter types.

The Sandia model consists of a set of equations that SAM uses to calculate the inverter's hourly AC output based on the DC input (equivalent to the electrical output of the photovoltaic array) and a set of empirically-determined coefficients that describe the inverter's performance characteristics. The equations involve a set of coefficients that have been empirically determined based on data from manufacturer specification sheets and either field measurements from inverters installed in operating systems, or laboratory measurements using the California Energy Commission (CEC) test protocol.

Because SAM does not track voltage levels in the system, it assumes that for each hour of the simulation, the inverter operates at the photovoltaic array's maximum power point voltage, given the solar resource data in the weather file for that hour.

The inverter single-point efficiency model calculates the inverter's AC output by multiplying the DC input (equivalent to the array's DC electrical output) by a fixed DC-to-AC conversion efficiency that you specify on the Inverter page. Unlike the Sandia inverter model, the single-point efficiency model assumes that the inverter's efficiency does not vary under different operating conditions.

**Note.** SAM's Sandia inverter library contains parameters for inverters in the List of Eligible Inverters per SB1 Guidelines at <http://www.gosolarcalifornia.org/equipment/inverters.php>. We try to keep the library as current as possible, but there may be periods when SAM's library is out of date. If the library appears to be out of date, you can check for updates by clicking the link on the Help menu to see if we have prepared a new module library.

If you are an inverter manufacturer and would like to add your inverter to the list, you should contact the California Energy Commission (CEC) or Sandia National Laboratories directly. For information about the Sandia Test and Evaluation program, see [http://energy.sandia.gov/?page\\_id=279](http://energy.sandia.gov/?page_id=279). For a list of Sandia contacts, see [http://energy.sandia.gov/?page\\_id=2772](http://energy.sandia.gov/?page_id=2772). For CEC contacts, see <http://www.gosolarcalifornia.ca.gov/equipment/add.php>.

The Sandia inverter model is described in King D et al, 2007. *Performance Model for Grid-Connected Photovoltaic Inverters*. Sandia National Laboratories. SAND2007-5036. [http://infoserve.sandia.gov/sand\\_doc/2007/075036.pdf](http://infoserve.sandia.gov/sand_doc/2007/075036.pdf). Also see the Sandia PV Modeling and Analysis website at [http://energy.sandia.gov/?page\\_id=2493](http://energy.sandia.gov/?page_id=2493) for more on PV system performance modeling.

The CEC inverter test protocol is described in Bower W et al, 2004. *Performance Test Protocol for Evaluating Inverters Used in Grid-Connected Photovoltaic Systems*. <http://bewengineering.com/docs/index.htm>

### **To use the Sandia inverter model:**

1. Choose an inverter from the list of available inverters. SAM displays the inverter's characteristics and model coefficients for your reference.

If you are modeling an inverter not included in the database and want to use the Sandia model, you can try to find an inverter with similar characteristics to your inverter's specifications.

Each inverter listing shows the manufacturer name, model number and AC voltage rating, and information in brackets about the organization responsible for generating the test data and the year the data was generated. "CEC" indicates that test data was generated by the California Energy Commission.

## Inverter Characteristics

When you select an inverter from the Sandia database on the Inverter page, SAM displays the inverter's parameters for your reference.

**Note.** SAM displays a few of the parameters from the library on the Inverter page. If you want to see the complete set of parameters in the Inverter library, you can do so in the [library editor](#).

The following table describes the parameters in the Sandia inverter library, which are explained in more detail in the King 2004 reference cited above.

### AC Voltage (Vac)

Rated output AC voltage from manufacturer specifications.

### Power ACo (Wac)

Maximum output AC power at reference or nominal operating conditions. Available from manufacturer specifications.

### Power DCo (Wdc)

Input DC power level at which the inverter's output is equal to the maximum AC power level. Available from manufacturer specifications.

### PowerSo (Wdc)

DC power required for the inverter to start converting DC electricity to AC. Also called the inverter's self-consumption power. Sometimes available from manufacturer specifications, and not to be confused with the nighttime AC power consumption.

### PowerNTare (Wac)

AC power consumed by the inverter at night to operate voltage sensing circuitry when the photovoltaic array is not generating power. Available from manufacturer specifications.

### Vdcmax (Vdc)

The inverter's maximum DC input voltage.

### Idcmax (Adc)

The maximum DC voltage input, typically at or near the photovoltaic array's maximum power point current.

### Coefficient 0 (1/V)

Empirically-determined coefficient that defines the relationship between AC and DC power levels at the reference operating condition.

### Coefficient 1 (1/V)

Empirically-determined coefficient that defines the value of the maximum DC power level.

### Coefficient 2 (1/V)

Empirically-determined coefficient that defines the value of the self-consumption power level.

**Coefficient 3 (1/V)**

Empirically-determined coefficient that defines the value of Coefficient 0.

**MPPT-low (Vdc)**

Manufacturer-specified minimum DC operating voltage, as described in CEC test protocol (see reference above).

**Vdco (Vdc)**

The average of MPPT-low and MPPT-high, as described in the CEC test protocol (see reference above).

**MPPT-hi (Vdc)**

Manufacturer-specified maximum DC operating voltage, as described in CEC test protocol (see reference above). The test protocol specifies that the inverter's maximum DC voltage should not exceed 80% of the array's maximum allowable open circuit voltage.

### 8.8.3 Array

The Concentrating Array page displays inputs for the high concentration photovoltaic (HCPV) performance model.

SAM assumes that HCPV modules are mounted on 2-axis trackers, and calculates tracking power consumption based on the tracking power that you specify. SAM allows you to set tracker limits and to set a maximum wind speed to move modules into stow position during periods of high wind.

#### Array Configuration

The array configuration variables determine the number of modules and inverters in the system.

**Number of trackers**

The total number of trackers in the array.

**Modules on each tracker**

The number of modules on each tracker.

**Single tracker nameplate capacity, kWdc**

The capacity in DC kilowatts of a single tracker at the reference radiation value specified on the [Module](#) page.

$$\text{Single Tracker Nameplate Capacity (kWdc)} = \text{Modules on Each Tracker} \times \text{Module Maximum Power (Wdc)} / 1000 \text{ (Wdc/kWdc)}$$

The module maximum power is Pmp from the [Module](#) page.

**System nameplate capacity, kWdc**

The array's nameplate capacity in DC kilowatts at the reference radiation value specified on the [Module](#) page.

$$\text{System Nameplate Capacity (kWdc)} = \text{Single Tracker Nameplate Capacity (kWdc)} \times \text{Number of Trackers}$$

### Number of inverters

The number of inverters specified on the [Inverter](#) page required to match the array's capacity.

$$\text{Number of Inverters} = \text{System Nameplate Capacity (kWdc)} / \text{Inverter DC Rated Power (Wdc)} / 1000 \\ (\text{Wdc/kWdc})$$

The number of inverters is the nearest integer greater than the nameplate capacity divided by a single inverter's rated DC capacity.

The inverter's rated DC capacity is Power DCo from the [Inverter](#) page.

**Note.** The HCPV model works only in conjunction with the Sandia inverter model option on the Inverter page. The inverter single-point efficiency model is only available for the flat-plate/low-x PV model.

### Inverter AC capacity, kWac

The total AC capacity of inverters in the system.

$$\text{Inverter AC Capacity (kWac)} = \text{Number of Inverters} \times \text{Inverter AC Rated Power (Wac)} / 1000 \\ (\text{Wac/kWac})$$

The inverter's rated AC capacity is Power ACo from the [Inverter](#) page.

## System Availability

System availability losses are reductions in the system's output due to operational requirements such as maintenance down time or other situations that prevent the system from operating as designed.

**Note.** To model curtailment, or forced outages or reduction in power output required by the grid operator, use the inputs on the [Grid Limits](#) page.

To edit the system availability losses, click **Edit losses**.

The [Edit Losses](#) window allows you to define loss factors as follows:

- Constant loss is a single loss factor that applies to the system's entire output. You can use this to model an availability factor.
- Hourly losses apply to specific hours of the year.

SAM reduces the system's output in each hour by the loss percentage that you specify for that hour. For a given hour, a loss of zero would result in no adjustment. A loss of 5% would reduce the output by 5%, and a loss of -5% would increase the output value by 5%. For subhourly simulations, SAM applies the loss factor for a given hour to each time step in that hour

## Tracker

The tracker options determine the type of two-axis active tracking used by the system.

### General tracking error factor

Defines losses due to tracker error.

### Single tracker power during operation, W

The total rated power of the tracking mechanism for a single tracker.

**Tracker elevation angle limits (degrees)**

Minimum and maximum values for the tracker elevation angle. SAM limits the tracker movement to values between the minimum and maximum.

**Tracker azimuth angle limits (degrees)**

Minimum and maximum values for the tracker azimuth angle. SAM limits the tracker movement to values between the minimum and maximum.

**Soiling and derates**

The soiling and derate factors account for losses in the system that the module and inverter models do not calculate, such as electrical losses in the DC wiring that connects modules in the array.

**Note.** For a discussion of derate factors in the context of the NREL PVWatts model that includes suggested values, see the Help system for the web version of PVWatts at <http://pwwatts.nrel.gov>. Note that SAM only includes derate factors for losses that the module, inverter, and shading models do not calculate.

**Monthly soiling factors**

Click **Edit Values** to specify the soiling derate factor that applies for each month of the year. A derate factor of 100 represents an array with no soiling, a value of 0 would be for an array that receives no sunlight. SAM assumes that Hour 1 of the 8,760 hours in a year is the hour ending at 1 am on Monday, January 1.

SAM applies the soiling derate factor to the direct radiation incident on the array.

**DC wiring loss factor**

A loss factor that SAM applies to the array's hourly DC output during the simulation.

**DC module mismatch loss factor**

A loss factor that SAM applies to the array's hourly DC output during the simulation.

**Diodes and connections loss factor**

A loss factor that SAM applies to the array's hourly DC output during the simulation.

**AC wiring loss factor**

A loss factor that SAM applies to the system's hourly AC output during the simulation.

**Estimated overall system conversion efficiency, %**

An estimate of the system's DC-to-AC conversion efficiency at nameplate conditions. SAM displays this value for reference only. During the simulation, it calculates the system's efficiency for each hour based on the available solar resource and system properties.

$$\text{Estimated Efficiency} = \text{Estimated Module Efficiency} \times \text{General Tracking Error} \times \text{DC Wiring Loss} \times \text{Average Annual Soiling Loss} \times \text{DC Module Mismatch} \times \text{Diode and Connections} \times \text{AC wiring} \times \text{Inverter AC Capacity} \div \text{Inverter DC Capacity}$$

Average Annual Soiling loss is the average of the 12 monthly soiling factors in the Edit Values window.

## Stowing

### Max allowed wind speed before stowing, m/s

Determines the wind speed that causes the trackers to move to stow position.

## Land Area

### Packing Factor

The packing factor is a multiplier that makes it possible to estimate the land area required by a project based on the total module area of the array.

**Note.** The packing factor only has an effect on simulation results when you specify land costs in \$/acre on the [PV System Costs](#) page.

### Total Land Area

The total land area is an estimate of the land area required by the PV system:

$$\text{Total Land Area} = \text{Overall Module Area (m}^2\text{)} \times \text{Number of Trackers} \times \text{Modules on Each Tracker} \times \text{Packing Factor} \div 4,047 \text{ (m}^2\text{/acre)}$$

Where Overall Module Area is from the [Module](#) page.

## Shading Derate

The azimuth-by-altitude table is a two-dimensional look-up table of beam shading factors. Each column in the table contains a set of shading factors for the solar azimuth value shown in the column heading. Each row in the table contains a set of shading factors for the solar altitude value in the row heading.

Solar azimuth values in the column headings must increase monotonically from left to right. Solar altitude values must increase monotonically from bottom to top.

For each hour in the simulation, SAM calculates the position of the sun as a set of solar azimuth and altitude angles. SAM uses a linear interpolation method to estimate the value of the beam shading factor for the hour based on the nearest values in the look-up table.

**Important Note:** Azimuth values use the following convention: 0 = north, 90 = east, 180 = south, 270 = west.

### To define the azimuth-altitude shading factor table by hand:

1. In **Rows** and **Cols**, type the number of rows and columns in the table.  
Specify a number of rows that is one greater than the number of azimuth values: For example for a table with ten rows of solar azimuth values, specify a **Rows** value of 11. Similarly, specify a **Cols** value that is one greater than the number of altitude values.
2. Type a set of column headings, solar azimuth values increasing from left to right.
3. Type a set of row headings with solar altitude values decreasing from top to bottom.
4. Type a beam shading factor value (between zero and one) in each cell of the table.

**To import or export azimuth-by-altitude beam shading factors:**

SAM allows you to import and export the azimuth-altitude lookup table as a comma-delimited text file that contains shading factors separated by commas. The file should have row or column headings.

- To export the shading matrix as a text file, click **Export**.
- To import a data from a comma-delimited text file, click **Import**.

## 8.8.4 System Costs

The HCPV System Costs page provides access to variables that define the installation and operating costs of a high concentration photovoltaic project. Debt-related and tax costs are specified on the [Financial Parameters](#) page.

SAM uses the variables on the HCPV System Costs page to calculate the project investment cost and annual operating costs reported in the project [cash flow](#) and used to calculate cost metrics.

Variable values in boxes with white backgrounds are values that you can edit. Boxes with blue backgrounds contain calculated values or values from other pages that SAM displays for your information.

SAM provides the categories under **Direct Capital Costs** and **Indirect Capital Costs** for your convenience to help keep track of project installation costs. Only the **Total Installed Cost** value affects the cash flow calculations, so you can assign capital costs to the different cost categories in whatever way makes sense for your analysis. For example, you could assign the cost of designing the array to the module cost category or to the engineering category with equivalent results. After you assign costs to the categories, you should verify that the total installed cost value is what you expect. SAM accounts for the total installed cost in Year 0 of the project [cash flow](#).

The Operation and Maintenance Costs categories are where you specify recurring project costs. SAM reports these annual costs in the project [cash flow](#) under the Operating Expenses heading.

**Note.** The default cost values that appear when you create a file or case are intended to illustrate SAM's use. The cost data are meant to be realistic, but not to represent actual costs for a specific project. For more information and a list of online resources for cost data, see the technology pages on the [SAM website](#).

### Direct Capital Costs

A direct capital cost represents an expense for a specific piece of equipment or installation service that applies in year zero of the cash flow.

**Note:** Because SAM uses only the total installed cost value in cash flow calculations, how you distribute costs among the different direct capital cost categories does not affect the final results.

#### Module (\$/Wdc or \$/Unit)

For the detailed photovoltaic model, the module cost is expressed per unit or per DC Watt:

- Dollars per DC watt multiplied by **Nameplate Capacity (at reference conditions)** on the [Array](#) page, or

- Dollars per unit multiplied by **Total Modules** on the Array page.

For the PVWatts System Model, the module cost is expressed per unit or per DC Watt:

- Dollars per watt multiplied by **Nameplate Capacity** on the [PVWatts Solar Array](#) page, or
- Dollars per unit, where the number of modules is assumed to be one.

### **Inverter (\$/Wac or \$/Unit)**

For the detailed photovoltaic model, the cost of inverters in the system is expressed in dollars per AC Watt or dollars per inverter:

- Dollars per AC watt multiplied by **Total Inverter Capacity** on the [Array page](#), or
- Dollars per unit multiplied by **Number of Inverters** in the **Actual Layout** column on the Array page.

For the PVWatts System Model, the inverter cost is either dollars per watt or dollars per inverter:

- Dollars per watt multiplied by the product of **DC Rating** and **DC to AC Derate Factor** on the [PVWatts Solar Array page](#), or
- Dollars per unit where the number of inverters is assumed to be one.

The other direct capital cost categories, **Tracking Equipment**, **Balance of system**, **Installation labor**, and **Installer margin and overhead** can be specified using three units. SAM calculates the total amount for each category as shown below.

### **\$**

A fixed cost in dollars.

### **\$/Wdc**

A cost proportional to the system's DC nameplate capacity, equal to the **Nameplate Capacity** on the [Array](#) page for the detailed photovoltaic model, or the **DC Rating** on the [PVWatts Solar Array](#) page for the PVWatts model.

### **\$/m2**

Applies only to the detailed photovoltaic model. A cost proportional to the total module area of the array in square meters, equal to the **Total Area** on the [Array](#) page. This option is not active for the PVWatts model.

### **Total**

For each category, the total is the sum of the three units.

$$\text{Total} = \$ + \$/Wdc \times \text{Nameplate Capacity (Wdc)} + \$/m2 \times \text{Total Area (m2)}$$

### **Contingency (%)**

A percentage of the sum of the module, inverter, balance of system, installation labor, and installer margin and overhead costs that you can use to account for expected uncertainties in direct cost estimates.

### **Total Direct Cost (\$)**

The sum of module, inverter, balance of system, installation labor, installer margin and overhead costs, and contingency costs.

## **Indirect Capital Costs**

An indirect cost is typically one that cannot be identified with a specific piece of equipment or installation service.



**Note:** Because SAM uses only the total installed cost value in cash flow calculations, how you distribute costs among the different indirect capital cost categories does not affect the final results.

The five indirect cost categories, **Permitting - Environmental Studies, Engineering, Grid interconnection** are each calculated as the sum of the three values expressed with the following units:

### % of Direct Cost

A percentage of the **Total Direct Cost** value shown under Direct Capital Costs.

### Cost \$/Wdc

A cost proportional to the system's DC nameplate capacity, equal to the **Nameplate Capacity** on the [Array](#) page for the detailed photovoltaic model, or the **DC Rating** on the [PVWatts Solar Array](#) page for the PVWatts model.

### Fixed Cost

A fixed cost in dollars.

### Total

For each category, the total is the sum of the three units:

$$\text{Total} = \% \text{ of Direct Cost} \times \text{Total Direct Cost (\$)} + \text{Cost \$/Wdc} \times \text{Nameplate Capacity (Wdc)} + \text{Fixed Cost (\$)}$$

### Land Costs

SAM calculates the total land cost as the sum of **Land** and **Land Preparation**. The land cost categories use the Cost \$/acre category in addition to the categories for the other indirect costs (% of Direct Cost, Cost \$/Wdc, Fixed Cost).

#### Total Land Area

The total land area from the [Array](#) page.

#### Cost \$/acre

A cost in dollars per acre of total land area.

#### Total

For each land cost category, the total is the sum of the three units:

$$\text{Total} = \text{Cost \$/acre} + \% \text{ of Direct Cost} \times \text{Total Direct Cost (\$)} + \text{Cost \$/Wdc} \times \text{Nameplate Capacity (Wdc)} + \text{Fixed Cost (\$)}$$

### Sales Tax (%)

#### Sales tax basis, %

The percentage of total direct cost used to calculate sales tax amount.

SAM calculates the total sales tax amount by multiplying the sales tax rate from the [Financial Parameters](#) page by the sales tax basis on the System Costs page:

$$\text{Total Sales Tax (\$)} = \text{Sales Tax Rate (\%)} \times \text{Sales Tax Basis (\%)} \times \text{Total Direct Cost (\$)}$$

For an explanation of the effect of sales tax on income tax, see **Sales Tax** on the [Financial Parameters](#) topic for the financial model you are using (Residential, Commercial, Single Owner, etc.)

## Total Indirect Cost (\$)

The sum of the five indirect cost categories and the sales tax.

## Total Installed Cost

The total installed cost is the sum of all of the direct and indirect capital costs that you specify. SAM uses this value to calculate the project's [net capital cost](#), which is the total installed cost less any cash incentives on the [Incentives](#) page and plus any additional financing costs from [Financial Parameters](#) page.

### Total installed cost (\$)

The sum of total direct cost and total indirect cost.

### Total installed cost per capacity (\$/Wdc or \$/kW)

Total installed cost divided by the total system rated or nameplate capacity. This value is provided for reference only. SAM does not use it in cash flow calculations.

## Operation and Maintenance Costs

Operation and Maintenance (O&M) costs represent annual expenditures on equipment and services that occur after the system is installed. SAM allows you to enter O&M costs in three ways: Fixed annual, fixed by capacity, and variable by generation. O&M costs are reported on the project [cash flow](#) in Years 1 and later..

For each O&M cost category, you can specify an optional annual **Escalation Rate** to represent an expected annual increase in O&M cost above the annual inflation rate specified on the [Financial Parameters](#) page. For an escalation rate of zero, the O&M cost in years two and later is the year one cost adjusted for inflation. For a non-zero escalation rate, the O&M cost in years two and later is the year one cost adjusted for inflation plus escalation.

For expenses such as component replacements that occur in particular years, you can use an annual schedule to assign costs to individual years. See below for details.

### Fixed annual cost (\$/yr)

A fixed annual cost that applied to each year in the project cash flow.

### Fixed cost by capacity (\$/kW-yr)

A fixed annual cost proportional to the system's rated or nameplate capacity.

### Variable cost by generation (\$/MWh)

A variable annual cost proportional to the system's total annual electrical output in AC megawatt-hours. The annual energy output depends on either the performance model's calculated first year value and the **degradation rate** from the [Lifetime](#) page, or on an annual schedule of costs, depending on the option chosen.

For systems with include battery storage:

### Battery replacement cost

The battery replacement cost in Year 1 dollars per kWh of installed battery capacity. SAM uses the inflation rate from the [Financial Parameters](#) page to calculate the replacement cost in the replacement year.

**Note.** To include battery replacements costs in your analysis, be sure to choose a battery replacement option on the [Battery Storage](#) page.

## Specifying O&M Costs in Specific Years

SAM allows you to specify any of the four operation and maintenance (O&M) cost categories on the System Costs page either as a single annual cost, or using a table of values to specify an annual schedule of costs. An annual schedule makes it possible to assign costs to particular years in the analysis period. Annual schedules can be used to account for component replacement costs and other periodic costs that do not recur on a regular annual basis.

You choose whether to specify an O&M cost as a single annual value or an annual schedule with the grey and blue button next to each variable. SAM uses the option indicated by the blue highlight on the button: A blue highlighted "Value" indicates a single, regularly occurring annual value. A blue highlighted "Sched" indicates that the value is specified as an annual schedule.

For example, to account for component replacement costs, you can specify the fixed annual cost category as an annual schedule, and assign the cost of replacing or rebuilding the component to particular years. For a 30-year project using a component with a seven-year life, you would assign a replacement cost to years seven, 14, and 21. Or, to account for expected improvements in the component's reliability in the future, you could assign component replacement costs in years seven, 17, and 27. After running a simulation, you can see the replacement costs in the project [cash flow](#) in the appropriate column under Operating Expenses. SAM accounts for the operating costs in the other economic metrics including the levelized cost of energy and net present value (NPV).

### Notes.

If you use the annual schedule option to specify equipment replacement costs, SAM does not calculate any residual or salvage value of system components based on the annual schedule. SAM calculates salvage value separately, using the salvage value you specify on the [Financial Parameters](#) page.

Dollar values in the annual schedule are in nominal or current dollars. SAM does not apply inflation and escalation rates to values in annual schedules.

The following procedure describes how to define the fixed annual cost category as an annual schedule. You can use the same procedure for any of the other operation and maintenance cost categories.

### **To assign component replacement costs to particular years:**

1. In the Fixed Annual Cost category, note that the "Value" label of the grey and blue button is blue indicating that the single value mode is active for the variable.

Fixed Annual Cost   284.00 \$/yr

In this case, SAM would assign an annual cost of \$284 to each year in the project cash flow.

2. Click the button so that "Sched" label is highlighted in blue. SAM replaces the variable's value with an Edit button.

Edit...

3. Click **Edit** to open the [Edit Schedule](#) window.
4. In the Edit Schedule window, use the vertical scroll bar to find the year of the first replacement, and type the replacement cost in current or constant dollars for that year.

To delete a value, select it and press the Delete key on your keyboard.

**Note.** You must type a value for each year. If you delete a value, SAM will clear the cell, and you must type a number in the cell or SAM will consider the schedule to be invalid. Type a zero for years with no annual costs.

5. When you have finished editing the schedule, click **Accept**.

Because you must specify an O&M cost category as either an annual cost or annual schedule, to assign both a recurring annual fixed cost and periodic replacement cost, you must type the recurring cost in each year of the annual schedule, and for years with replacement costs, type the sum of the recurring and replacement costs.

## 8.8.5 Results

After running a simulation, SAM displays time series results for the high concentration photovoltaic (HCPV) model on the Results page [Tables](#) and [Time Series](#) graphs.

### Hourly Data

Variable Name	Units	Description
AC gross	kWh	System gross AC output, before AC derate.
Beam	W/m2	Direct normal radiation from weather file.
Cell eff	%	Cell conversion efficiency at POA on cell (from table on Module page).
Cell temp	'C	Cell temperature.
DC gross	kWh	Array gross DC output, before DC derate.
DC net	kWh	Array DC output, after DC derate.
Dry bulb temp	'C	Ambient temperature from weather file.
Hourly Energy	kWh	System net AC output, after AC derate.
Hourly Energy Delivered	kWh	System output
Input radiation	kWh	Product of total radiation incident on array and array area.
Module backplate temp	'C	Temperature of back of module.
Module eff	%	Module conversion efficiency (input radiation to DC gross).
POA on cell	W/m2	Total radiation incident on cell.
Relative air mass		Atmospheric optical length.
Shading derate		DC derate factor due to array shading.
Solar azimuth	deg	Azimuth angle of the sun.
Solar zenith	deg	Zenith angle of the sun.
Sun up	0/1	0 = no sun, 1 = sun.
Tracker azimuth	deg	Array angle from due north.
Tracker tilt	deg	Array tilt angle from horizontal.
Wind speed	m/s	Wind speed from weather file.

## Monthly Data

Variable Name	Units	Description
AC net	kWh	Total system AC output, after AC derate.
Beam	Wh/m <sup>2</sup>	Total direct normal radiation incident on array.
DC net	kWh	Total array DC output, after DC derate.
Input Radiation	kWh	Product of monthly beam radiation and module area.
Monthly Energy Delivered	kWh	Total AC output of the system by month.

## 9 Battery Storage

The battery storage model is available as part of the following performance models:

- Detailed PV-Battery integrates battery storage with the Detailed Photovoltaic model.
- Generic System-Battery integrated battery storage with the Generic System model.

SAM can model behind-the-meter (BTM) and front-of-meter (FOM) storage applications, determined by the financial model:

- The distributed financial models (Residential, Commercial, and Third Party Ownership) are for behind-the-meter storage, where power from the system is used to reduce a residential or commercial customer's electricity bill.
- The PPA and Merchant Plant financial models are for front-of-meter storage, where power from the system is sold to generate revenue.

SAM does not have a standalone battery model, but you can model such a system using the Generic Battery configuration with a nominal capacity factor of zero.

The battery storage model allows you to analyze the performance of the following types of batteries:

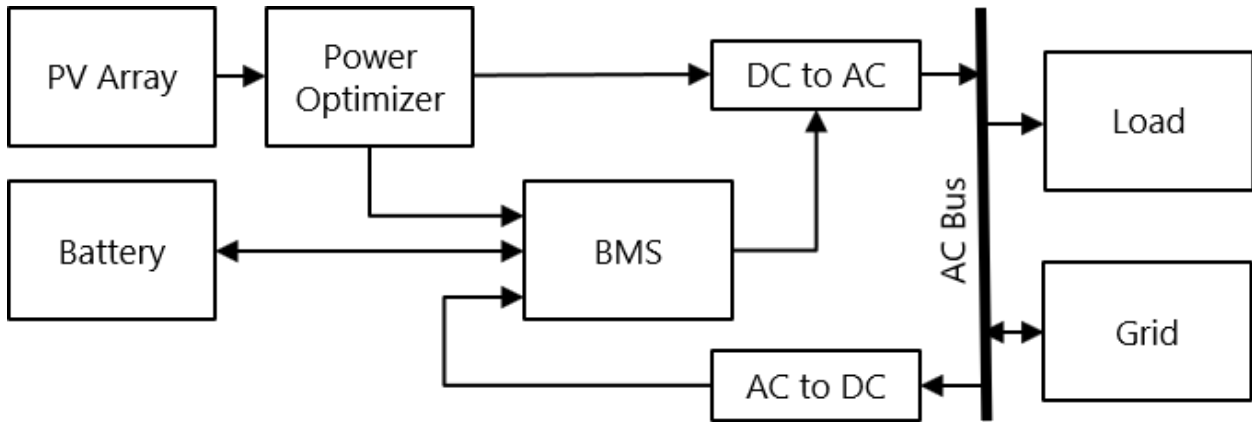
- Lead-acid
- Lithium-ion
- Vanadium redox flow
- All iron flow

SAM has automatic dispatch controller options for peak shaving applications or applications that respond to time-varying power prices. It also has "manual" dispatch options where you provide a schedule or time-series instructions for when to charge and discharge the battery. SAM's detailed voltage, temperature, and degradation models account for how operating conditions affect battery degradation over time to determine when battery replacements are required.

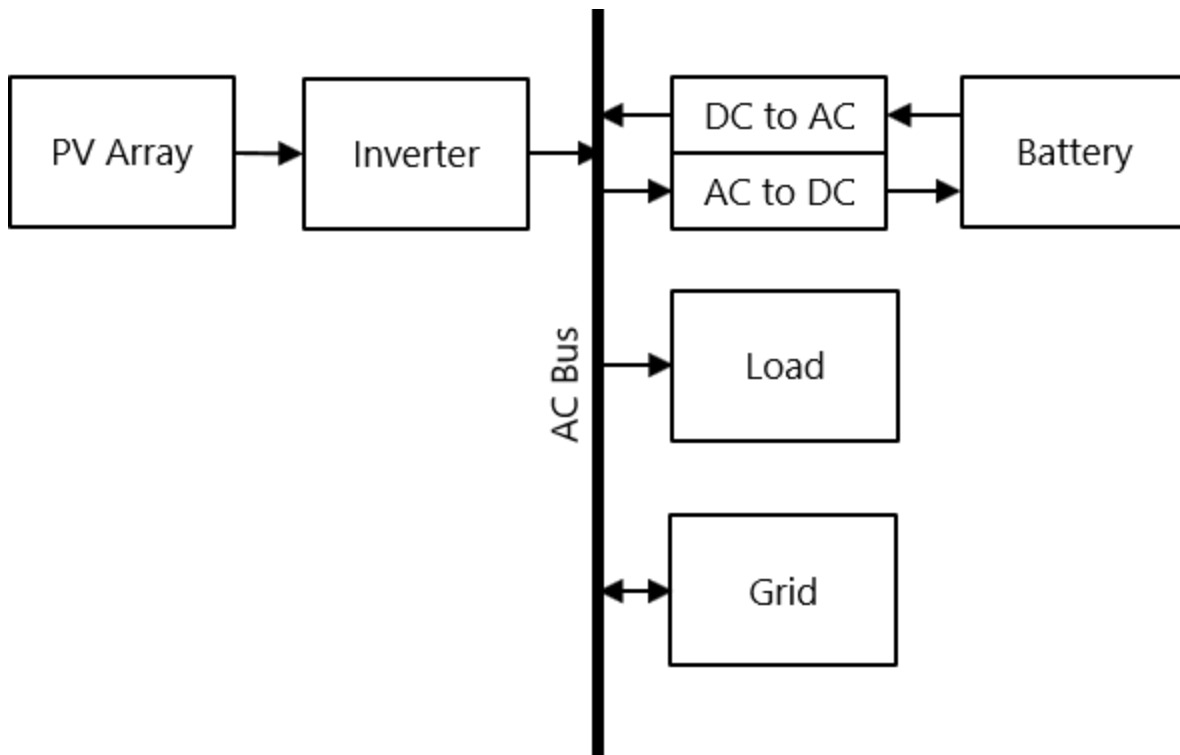
For more about the SAM's battery model, see the [Battery Publications](#) page on the SAM website.

## 9.1 Behind the Meter (BTM)

The behind-the-meter (BTM) battery model assumes that the battery is used to reduce a residential or commercial building or facility owner's electricity bill. SAM assumes the battery is behind the meter for the Distributed financial models (Residential, Commercial, Third Party Ownership). The battery in a PV-battery behind-the-meter application may be connected either to the AC or DC side of the inverter as shown in Figures 1 and 2.

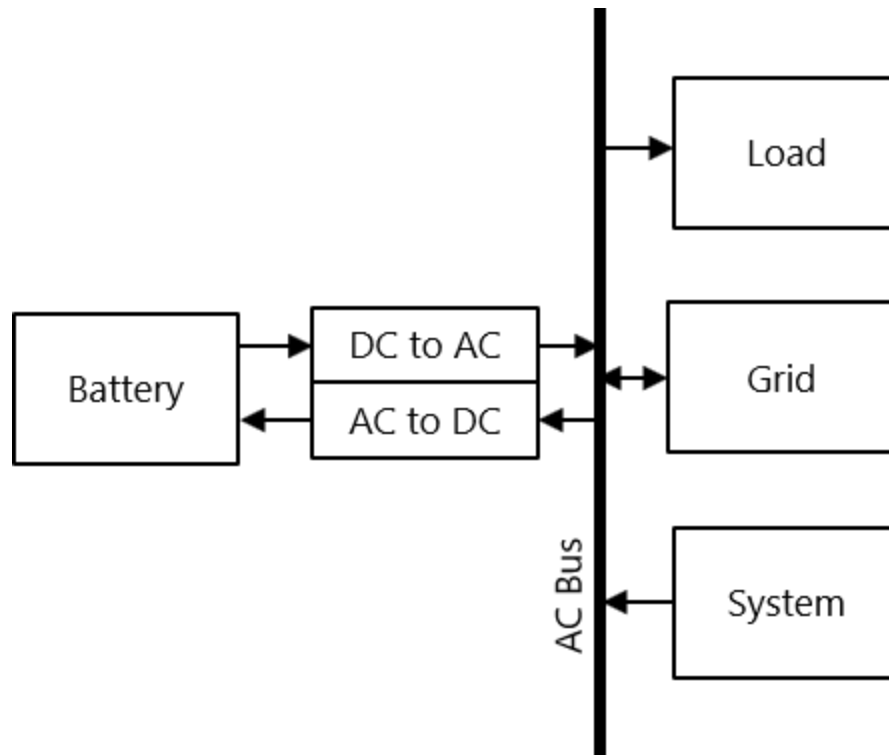


**Figure 1: PV-battery DC-connected Behind the meter**



**Figure 2: PV-battery AC-connected Behind the meter**

The battery in a generic behind-the-meter application is connected to the AC side of the system as shown in Figure 3.

**Figure 3: Generic-battery AC-connected Behind the meter**

## Chemistry

The battery type defines the battery chemistry for (lithium ion, lead acid, or flow battery), and the type of battery for each chemistry. When you choose a battery type, SAM automatically changes the battery property input variables to default values for that type. These default values were drawn from DiOrio (2015) "Technoeconomic Modeling of Battery Energy Storage in SAM" cited above, which also includes more details on how SAM calculates battery capacity.

### Battery type

Choose the battery chemistry and battery type for the batteries in your system.

When you choose a battery type, SAM replaces the values of **Voltage Properties** and **Current and Capacity** input variables as appropriate with values for each battery type.

When you choose a custom battery type for either the lead acid or lithium ion chemistry, SAM does not replace the input variable values.

**Notes.**

To model a battery type not included in the list, choose either **Lead Acid: Custom** or **Lithium Ion: Custom**, and specify your voltage, current, and capacity properties appropriate for the battery.

When you choose the custom lead acid battery type, SAM retains the capacity and discharge rate values from the table below from the previous state. For example, if you change the battery type from flooded lead acid to custom lead acid, SAM will apply the capacity/discharge rate table for flooded batteries to your custom battery.

**Lead Acid**

The three lead acid battery types use the lead acid battery capacity model described in DiOrio (2015), cited above:

- Flooded lead acid batteries with a liquid electrolyte.
- Valve Regulated (VRLA) batteries are sealed, and the electrolyte is bound in a gel.
- VRLA Absorptive Glass Mat (AGM) batteries are sealed, and the electrolyte is immobilized in porous separators.

Lead acid battery capacity is dependent on the discharge rate. When you choose different lead-acid battery types from the list, SAM changes internal variable values that define the relationship between capacity and discharge rate as shown in the table below. It is not possible to change these values from the Battery Storage input page. These values are based on analysis of information for batteries from different manufacturers. SAM considers the 20-hour discharge rate to be the nominal capacity of a lead-acid battery and scales the capacity at faster discharge rates as a percent of the that 20-hour capacity.

Discharge Rate	Capacity %		
	Flooded	VRLA Gel	VRLA AGM
20-hr ( 0.05 C )	100	100	100
10-hr ( 0.1C )	87	84.9	93.2
1-hr ( C )	47	63.1	58.1

**Lithium Ion**

The six lithium ion battery types use of the lithium-ion battery capacity model described in DiOrio (2015) "Technoeconomic Modeling of Battery Energy Storage in SAM" cited above:

- LMO: Lithium Manganese Oxide ( $LiMn_2O_4$ ) – An inexpensive high-voltage cathode material with high power capabilities but potentially lower lifespan.
- LFP: Lithium Iron Phosphate ( $LiFePO_4$ ) – A lower voltage cathode material with excellent safety properties but lower volumetric energy.
- LCO: Lithium Cobalt Oxide ( $LiCoO_2$ ) – Among the first and still a common cathode material with high specific energy, but potentially costly and toxic.
- LTO: Lithium Titanate ( $Li_4Ti_5O_{12}$ ) – A promising anode material with excellent lifetime properties but lower specific capacity and important cost considerations.



- NMC: Nickel Manganese Cobalt ( $LiNiMnCoO_2$ ) – A less expensive cathode material than LCO with potentially improved safety characteristics
- NCA: Nickel Cobalt Aluminum ( $LiNiCoAlO_2$ ) – Similar in respects to NMC as a cathode material with high specific energy

When you choose a lithium ion battery, SAM assigns values to voltage, lifetime, and thermal properties as appropriate from Reddy (2011), cited above, and from manufacturer data sheets. SAM does not change any internal variables or calculations.

## Flow Batteries

Flow battery designers can decouple power output (kW) from energy capacity (kWh) when sizing systems. Flow batteries may be able to cycle more deeply and operate for more total cycles than lithium ion or lead acid batteries, but flow batteries also have pumps, which should be considered when calculating **Ancillary Equipment Losses**.

### Vanadium Redox Flow

The vanadium redox flow battery model available in SAM comes from R. D'Agnostino et. al, (2014) "A Vanadium-Redox Flow-Battery Model for Evaluation of Distributed Storage Implementation in Residential Energy Systems"

- VRFB: Vanadium Redox Flow ( $V^{2+}, V^{3+}$  anolyte), ( $VO^{2+}, VO^{2+}$ , catholyte)

### All Iron Redox Flow

The all iron redox flow battery model available in SAM shares the same input field framework as the vanadium flow battery, but relies on tabular voltage vs. depth-of-discharge in place of a voltage model. Default iron flow battery values are based on preliminary manufacturer data and feedback for an all-iron hybrid-redox flow battery.

- AIFB: All Iron Redox Flow ( $Fe^{2+}, Fe^{3+}$ )

## Battery Bank Sizing

The two battery bank sizing options allow you to either automatically size the battery bank based on desired size, or to specify the number of cells and their configuration in the bank yourself. The automatic option is suitable for an initial preliminary design. It uses the basic equations described below to determine numbers of cells and strings or stacks, but does not take into account real-life design considerations that are outside of the model's scope. If you use the automatic sizing option, you should refine the bank sizing parameters by specifying your own values after analyzing the initial results.

### Set desired bank size

Choose this option to have SAM calculate a number of cells in series and strings in parallel based on the desired bank capacity and power values you enter.

If you choose this option, be sure to verify the values under Computed Properties to make sure SAM was able to calculate values close to the desired values.

### Specify cells

Choose this option to manually specify the number of cells in series, strings in parallel and C-rates of charge and discharge.

### Desired bank capacity, kWh

For the Set desired bank size option, the size of the battery bank in kWh. Compare this to the Nominal bank capacity under Computed Properties to verify that SAM calculated a nominal value close enough

to the desired value to meet your requirements.

**Desired bank power, kW**

For the Set desired bank size option, the maximum discharge rate in kW. Compare this to the Maximum discharge power under Computed Properties to verify that SAM calculated a discharge power close enough to the desired value to meet your requirements.

**Number of cells in series**

For the Number of cells in series option, the number of cells in series in the battery bank. The number of cells in series determines the maximum discharge power.

**Number of strings in parallel**

For the Specify cells option, the number of strings of cells in parallel in the battery bank. The number of strings in parallel determines the nominal bank capacity.

**Max C-rate of charge, 1/hour****Max C-rate of discharge, 1/hour****To automatically size the battery bank:**

1. Click **Set desired bank size**.
2. Enter values for **Desired bank capacity** in kilowatt-hours and **Desired bank power** in kW. Choose either **DC** or **AC** as appropriate for your battery ratings.
3. The default desired battery bank voltage is depends on the battery chemistry. If you want to change the nominal DC voltage of the battery bank, expand the **Battery Voltage** panel, and change the **Desired bank voltage** in DC Volts under **Voltage Properties**.
4. Under **Computed Properties** in the **Current and Capacity** group, check the **Nominal bank capacity** and **Nominal bank voltage** to make sure they are close enough to your desired values. Also check that **Maximum discharge power (DC)** is close to your desired bank power.

You can estimate the nominal battery bank hours of autonomy by dividing the capacity in kWh by the maximum discharge power in kW, which is shown as **Time at maximum power**.

If you use AC ratings for the capacity and power values, SAM converts them to DC using the **DC to AC conversion efficiency** you specify under **Power Converters**.

See [Calculations for Automatic Bank Sizing](#) for details about how SAM determines the bank size based on the values you enter.

**To manually size the battery bank for conventional batteries:**

1. Click **Specify cells**.
2. Enter values for **Number of cells in series** and **Number of strings in parallel**.
3. Enter values for **Max C-rate of charge** and **Max C-rate of discharge**.

Batteries typically have some limits based on chemistry for how much power can be input during charging or extracted during discharging. The C-rate is the current divided by the nominal capacity at that current. A one-hour discharge rate is 1C, whereas a half-hour rate is 2C and a two-hour rate is 0.5C. If this value is reported on a battery data sheet in units of power, then calculate the C-rate either as:

$$C = P \div (V \times Q)$$

$$C = P \div E$$

Where,

$P$  = power limit in units of W

$V$  = the nominal voltage of the battery bank in V

$Q$  = nominal charge of battery bank in Ah

$E$  = nominal bank capacity in Wh

SAM's battery thermal model also considers current flow as a primary mechanism for battery heating. Reducing the maximum current charge and discharge is one way to reduce thermal losses and improve battery efficiency.

4. Use the values under **Computed Properties** in the **Current and Capacity** section to check your design.

#### **To manually size the battery bank for flow batteries:**

1. Click **Specify capacity and stack configuration**. If you do not see this option, be sure to choose a flow battery from the **Battery type** list under **Chemistry**.
2. Enter values for **Number of cells per stack**.
3. Enter values for **Number of parallel stacks** and **Number of stacks in series**.
4. Enter a value for the **Bank capacity in kWh**.
5. Use the values under **Computed Properties** to check your design.

**Note.** Since the capacity and power of a flow battery are decoupled, the C-rate is a computed byproduct of the configuration rather than an input design constraint.

### **Calculations for Automatic Bank Sizing**

SAM's bank sizing calculations use basic equations using the cell property information you specify. The calculated values are designed to help you get started with your system design. They do not account for many real-life design factors. You should use these values for an initial preliminary analysis and then use **Specify cells** for conventional batteries or **Specify capacity and stack configuration** for flow batteries to refine your analysis.

#### **Number of cells in series, Number of cells per stack**

SAM calculates a number of cells in series for a conventional battery, or cells per stack for a flow battery assuming one stack, that either meets exactly or slightly exceeds the desired bank voltage based on the cell nominal voltage. For example, for a desired bank voltage of 24 V with a nominal cell voltage of 3.6 V, SAM calculates  $24\text{ V} \div 3.6\text{ V/cell} = 6.7$ , or 7 cells in series. The actual nominal bank voltage is  $3.6\text{ V/cell} \times 7\text{ cells} = 25.2\text{ V}$ . SAM displays the actual battery bank properties as calculated values under Current and Capacity.

#### **Number Strings in parallel (Lithium ion, lead-acid)**

SAM calculates the bank capacity by determining the number of strings of cells in parallel required to ensure that the actual capacity is as close as possible to the desired value given the cell capacity that you specify under **Current and Capacity**. For the example above, if the desired bank capacity is 3 kWh, and the cell capacity is 1.5 Ah, the calculated bank voltage would be 25.2 V, and one string of cells has a capacity of  $25.2\text{ V} \times 1.5\text{ Ah} = 37.8\text{ Wh}$ , or 0.0378 kWh. To reach the desired bank capacity of 3 kWh:  $3\text{ kWh} \div 0.0378\text{ kWh/string} = 79.4$ , or 80 strings.

The calculated C-rates of charge and discharge are the desired bank power divided by the computed bank capacity.

### Capacity and Stack Configuration (Vanadium redox flow, all iron redox flow)

For flow batteries, the capacity is independent of the power block and can be specified exactly by the amount of electrolyte in the tanks. SAM sets nominal bank capacity to the desired capacity you specify. SAM calculates the nominal power ratings using the desired stack (bank) voltage and other properties in the **Current and Capacity** group. The number of stacks in parallel depends on whether the cells are power limited or current limited.

For the **Power limited** option, the number of stacks in parallel is the ceiling of the desired bank power divided by the product of **Cell max power discharge** and the number of cells in the stack (assuming one stack in series). For example, consider a flow battery with a desired bank capacity of 100 kWh, bank power of 50 kW, and bank voltage of 48V with 1.4V cells and a cell power discharge max of 2W. The number of cells in the stack is  $\text{ceiling}(48V \div 1.4V/\text{cell}) = \text{ceiling}(34.2 \text{ cells}) = 35 \text{ cells}$ . The bank voltage is  $35 \text{ cells} \times 1.4V/\text{cell} = 49V$ . To achieve 50KW with limitations of 2W/cell, there must be  $\text{ceiling}(50 \text{ kW} / (0.002 \text{ kW/cell} * 35 \text{ cells})) = 715 \text{ stacks in parallel}$ .

For the **Current limited** option, the number of stacks in parallel is the ceiling of the desired bank power divided by the product of the battery bank voltage and **Cell max current discharge**. In the example above, if all properties are the same except the battery is current limited with 10A per cell (and consequently per stack), the number of stacks in parallel must be:  $\text{ceiling}(50 \text{ kW} / (49V * 10 \text{ A} * 0.001)) = 103 \text{ stacks in parallel}$ .

For the **Limit both current and power** option, the stacks are sized by using the current limit, and within the model at each time step the current and power through the cells are checked and reduced if necessary.

### Optimal Sizing and Dispatch from REopt

For behind-the-meter storage applications, you can use the Optimal Sizing and Dispatch from REopt option to automatically size the battery system based on the value of lost load during grid outages. This option only works in SAM with hourly simulations.

For information about the resiliency model, see Evaluate Distributed Energy Technologies for Cost Savings and Resilience With REopt Lite, National Renewable Energy Laboratory, 2pp., FS-7A40-76358 ([PDF 245 KB](#))

For information about REopt Lite, see <https://reopt.nrel.gov/tool>.

### Current and Capacity

The Current and Capacity parameters depend on the battery chemistry:

- For lead acid and Lithium-ion batteries, you specify a cell capacity value, and SAM displays the computed properties based on the battery bank sizing parameters.
- For flow batteries, you choose whether the battery is power- or current-limited and specify minimum and maximum rates.

### Lead Acid and Lithium-ion Battery Parameters

#### Cell capacity

The capacity of a single cell when the battery is fully charged. SAM sets this value to a default value when you choose a battery chemistry, but you can change its value.

### Flow Battery Parameters

**Power limited with Cell max power charge and discharge**

Limit the maximum charge and discharge power.

**Current limited with Cell max current charge and discharge**

Limit the maximum charge and discharge current.

**Limit both current and power**

Limit both the charge limits by both power and current.

**Computed Properties**

These are the values that SAM uses for simulation. The values may either be ones that you specify or that SAM calculates, depending on whether you choose the **Set desired bank size** or **Specify cells** option.

**Nominal bank capacity**

The product of total number of cells and cell capacity.

**Nominal bank voltage**

The product of number of cells in series and the cell nominal voltage as specified under **Bank Voltage**.

**Cells in series / Cells per stack**

The number of battery cells in series in each string of cells, which determines the battery bank voltage. Either the value you specify explicitly, or that SAM calculates as described above.

**Strings in parallel / Stacks in parallel**

The number of parallel strings of battery cells, determines the battery bank capacity. Either the value you specify explicitly, or that SAM calculates as described above.

**Stacks in series**

For flow batteries, the number of stacks in series.

**Max C-rate of discharge**

Either calculated from  $\text{Maximum Discharge Power} \div \text{Nominal Bank Capacity}$ , or user input.

**Max C-rate of charge**

Either calculated from  $\text{Maximum Charge Power} \div \text{Nominal Bank Capacity}$ , or user input.

**Maximum discharge power, DC kW**

The maximum discharge power, calculated from the nominal bank capacity and maximum C-rate of discharge. This is also the nominal DC power of the battery bank.

**Maximum charge power, DC kW**

The maximum charge power, calculated from the nominal bank capacity and maximum C-rate of charge.

**Maximum discharge power, AC kW**

The maximum discharge power, calculated from the nominal bank capacity, maximum C-rate of discharge, and DC to AC conversion efficiency.

**Maximum charge power, AC kW**

The maximum discharge power, calculated from the nominal bank capacity, maximum C-rate of charge, and DC to AC conversion efficiency..

**Time at maximum power**

The nominal bank capacity divided by the maximum power, or 1 divided by the maximum C-rate of discharge.

**Maximum discharge current**

Calculated from the maximum C-rate of discharge: Max Discharge Current =  $1000 \times \text{Max C-rate of Discharge} \times \text{Nominal Bank Capacity} \div \text{Nominal Bank Voltage}$ .

**Maximum charge current**

Calculated from the maximum C-rate of charge: Maximum Charge Current =  $1000 \times \text{Maximum C-rate of Charge} \times \text{Nominal Bank Capacity} \div \text{Nominal Bank Voltage}$ .

**Power Converters**

For photovoltaic-battery systems, SAM can model a battery that is connected to either the DC or AC side of the photovoltaic inverter.

**Notes.**

The Power Converters inputs are only available with the PV Battery configuration. They are not available with the Generic Battery configuration, which assumes that the battery is the only DC component in the system.

The Power Converters inputs account for electrical losses associated with converting between DC and AC power for the batteries in the system. For all power converters except the photovoltaic inverter, SAM models the converter performance using the fixed conversion efficiency values you provide.

The photovoltaic inverter is a separate component from the power converter equipment specified here and uses a more sophisticated model with an efficiency curve that varies with the inverter load. You specify the photovoltaic inverter model and parameters on the [Inverter](#) page.

**DC Connected**

Choose the DC Connected option for a battery connected to the DC side of the photovoltaic inverter through a battery management system (BMS) so that the same inverter converts DC power from the BMS and photovoltaic array to AC power. This configuration also requires a DC power optimizer or DC/DC converter to connect the photovoltaic array to the BMS and inverter as shown in the diagram above.

To account for electrical losses from the DC power optimizer, be sure to assign an appropriate value to the **DC power optimizer loss** on the [Losses](#) page.

For a DC-connected battery, during time steps when the total power from the photovoltaic array and battery is greater than the inverter's nameplate capacity, the inverter limits its output power to the nameplate capacity. For the automated dispatch options with **Battery can charge from clipped system power** enabled, if the battery is not fully charged and is not discharging, the excess power from the array charges the battery.

**DC to DC conversion efficiency, %**

For the DC-connected option, the electrical conversion efficiency of the battery management system (BMS). SAM applies this loss to power into or out of the battery BMS as energy enters and leaves the battery. SAM disables this input for the AC Connected option.

**Inverter efficiency cutoff, %**

For the DC-connected option, the inverter efficiency cutoff is an inverter efficiency threshold below which the battery is not allowed to charge or discharge through the inverter.

**AC Connected**

Choose the AC-connected option for a battery connected to the system between the inverter and grid interconnection point. Power conversion equipment is required to convert DC power from the battery to AC power before it can serve the load or be sent to the grid, and to convert AC power from the inverter or grid before it can charge the battery.

**AC to DC conversion efficiency, %**

For the AC-connected option, the electrical conversion efficiency associated with the equipment that converts the AC power from either the photovoltaic inverter or grid to DC power for the battery. SAM disables this input for the DC Connected option.

**DC to AC conversion efficiency, %**

For the AC-connected option, the electrical conversion efficiency associated with the equipment that converts the DC power from the battery to AC power for either the AC load or grid, or both. SAM disables this input for the DC Connected option.

**Battery Lifetime**

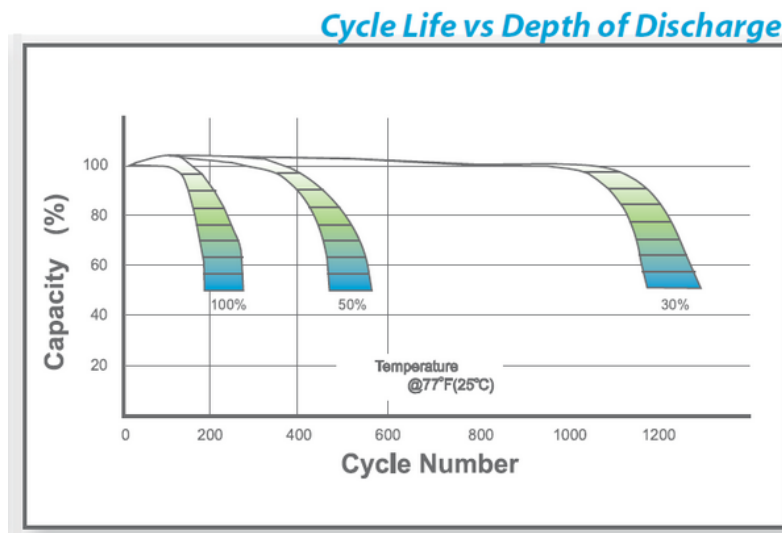
SAM's battery lifetime model considers battery cycling and age as the primary causes of capacity degradation.

**Cycle Degradation**

Cycle degradation is a reduction in the battery's capacity at 100% charge as the battery is charged and discharged. The cycle degradation model relies on information about capacity fade at the number of cycles elapsed at an average depth of discharge. If you enter your own cycle degradation data, you should enter at least two or three sets of data for two or three different depths of discharge.

You must provide at least three rows of data. For a table with more than one depth-of-discharge value, SAM uses bilinear interpolation to consider both the average depth-of-discharge and cycle number when applying the capacity fade. If the table contains data for a single depth-of-discharge value, then SAM only considers the cycle number in the capacity fade calculation using a rainflow counting algorithm.

For example, given the following graph from a battery's datasheet:



You might enter the following data in the table:

**Battery Lifetime**

	Depth-of-discharge (%)	Cycles Elapsed	Capacity (%)
Import...	30	0	100
Export...	30	1100	90
	30	1200	50
Copy	50	0	100
Paste	50	400	90
	50	500	50
Rows:	100	0	100
	100	100	90
	100	150	50

Some battery data sheets do not report this kind of information. For these batteries, you can use the default values in the table.

### Calendar Degradation

Calendar degradation is a reduction in capacity over a battery's life that occurs over time. This degradation may be a function of time, temperature and state of charge, or simply a function of time.

#### Lithium-ion model

The Lithium-ion model accounts for how a Lithium-ion battery's capacity degrades with time, temperature, and state-of-charge. For a description of the model, see Smith, K.; Saxon, A.; Keyser, M.; Lundstrom, B.; Cao, Z.; Roc, A. (2017). [Life Prediction Model for Grid-Connected Li-ion Battery Energy Storage System](#). 7 pp. 2017 American Control Conference, Seattle, USA.



**Calendar Degradation**  
 None     Lithium-ion model     Enter custom

**Lithium-ion Model**  
 $q = q_0 - k_{cal} * \text{sqrt}(t)$   
 $k_{cal} = a * \exp[b(1/T - 1/296)] * \exp[c(\text{SOC}/T - 1/296)]$

q0: 1.02 fraction    a: 0.00266 1/sqrt(day)  
 b: -7280 K    c: 930 K

**Custom Degradation**

Battery age (days)	Capacity (%)
0	100
3650	80
7300	50

Rows: 3

**Custom degradation**

The custom degradation option allows you to enter your own degradation curve. To enter the curve, click **Custom degradation**, and for **Rows**, type the number of capacity as % of nominal full capacity and battery age in days data points on your degradation curve. Then type the values in the table, and check the curve for the correct shape.

**Calendar Degradation**  
 None     Lithium-ion model     Custom degradation

**Lithium-ion Model**  
 $q = q_0 - k_{cal} * \text{sqrt}(t)$   
 $k_{cal} = a * \exp[b(1/T - 1/296)] * \exp[c(\text{SOC}/T - 1/296)]$

q0: 1.02 fraction    a: 0.00266 1/sqrt(day)  
 b: -7280 K    c: 930 K

**Custom Degradation**

Battery age (days)	Capacity (%)
0	100
3650	80
7300	50

Rows: 3

**Battery Replacements**

Battery degradation as a reduction in available storage capacity over time caused by battery cycling (charge and discharge cycles) and age. If you model battery replacements, SAM calculates an annual replacement cost in the project cash flow based on the replacement options specified here and the replacement cost on the System Costs page.

**No replacements**

Use this option if you do not want to account for battery replacement costs, or if you want to account for them using one of the Operation and Maintenance cost categories on the [System Costs](#) page.

If you choose the No replacements option, SAM operates the system with no battery after the available storage capacity is depleted.

#### Replace at specified capacity

Use this option if you want SAM to calculate the year(s) in which batteries are replaced based on degradation of the battery's capacity caused by battery cycling as determined from the **Battery Lifetime** parameters.

Set **Battery bank replacement threshold** as percentage of the battery's rated capacity that triggers a replacement. When the battery's available capacity has degraded to this percentage, SAM replaces the battery and applies the battery replacement cost from the [System Costs](#) page to the project [cash flow](#). If you set the threshold to less than 2%, SAM sets the value internally to 2% to avoid simulation issues as the battery's available capacity approaches 0% of its original capacity.

#### Replace at specified schedule

Use this option to specify the years when batteries are replaced and the percent of battery capacity that is replaced in those years.

Use the **Battery bank replacement schedule** option to force all batteries to be replaced in a given year or years, regardless of degradation. Click **Edit array** to specify the percentage of total battery capacity to be replaced in each replacement year. In the Edit Array window, click **Number of values**, and enter the analysis period from the [Financial Parameters](#) input page. Then in the table, type a percentage for each year in which the batteries will be replaced. The rows for the remaining years should be zero.

## Battery Voltage

The voltage properties are technical specifications available on most battery manufacturer data sheets.

Battery voltage varies with state of charge as the internal open circuit potential decreases or increases. When a battery charges, positive ions travel from the cathode to the anode, lowering the open circuit potential of the anode and increasing the open circuit potential of the cathode, resulting in a net increase of potential between the anode and cathode. Similarly, as a battery discharges, ions flow back from the anode to the cathode, reducing the net potential. Battery manufacturer data sheets typically report a voltage-discharge curve of some kind to illustrate this behavior. SAM uses a dynamic voltage model, which specifies how to extract information from a data sheet to populate the voltage discharge curve.

Voltage variations in charging and discharging affect the battery's round-trip efficiency. During charging, voltage increases, requiring more power to charge the cell. During discharge the voltage decreases and less power can be extracted. The round-trip efficiency is computed as the net amount of energy discharged from a cell divided by how much energy it took to charge the cell.

## Voltage Properties Common to All Chemistries

The following voltage properties are available for all of the battery chemistry options.

#### Desired bank voltage

The battery bank voltage you are trying to achieve in your design. SAM calculates the number of cells in series based on the desired bank voltage and cell nominal voltage:

$$\text{Number of Cells in Series} = \text{ROUND UP} ( \text{Desired Bank Voltage} \div \text{Cell Nominal Voltage} )$$

#### Cell nominal voltage

The reference voltage of a single, fully charged cell in the battery as reported by the manufacturer. The typical nominal voltage for a lead acid cell is 2 V, and for lithium ion cell is 3.7 V.

SAM uses the nominal voltage to size the battery bank and compute the battery bank's nominal voltage.

### Cell Internal resistance

The cell internal resistance for each cell in the battery in Ohms. SAM assumes that this is a constant value and uses it in voltage and thermal calculations by scaling the cell internal resistance to a total battery resistance based on the cell configuration.

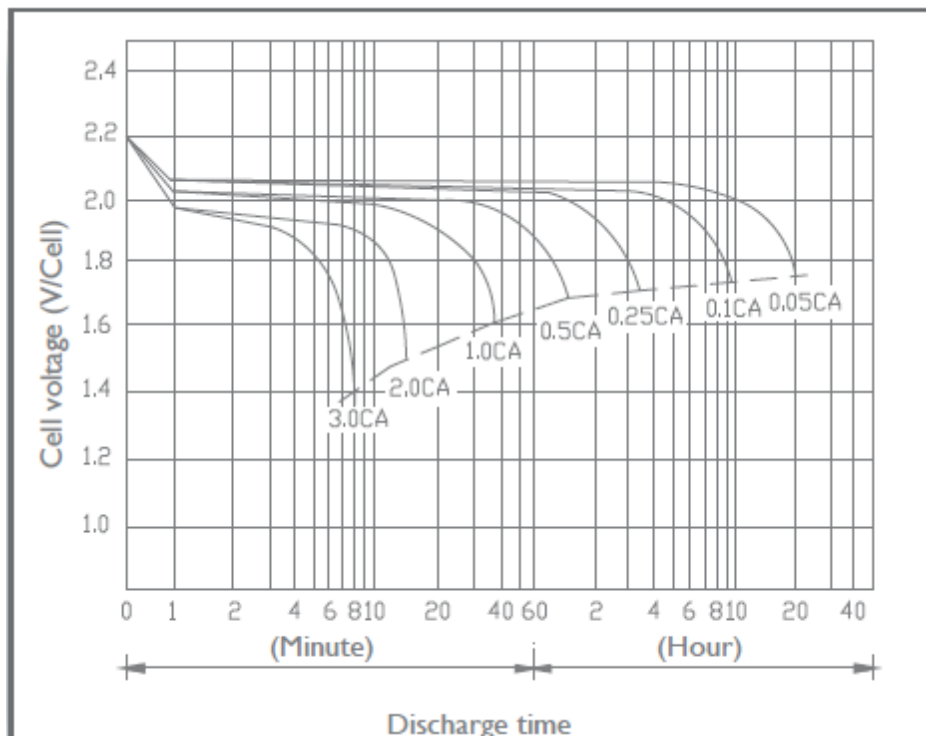
## Electrochemical Properties

The electrochemical model properties apply to the lead acid and Lithium-ion battery types. They are disabled for the flow battery types.

SAM displays the Voltage Discharge graph based on the electrochemical properties you specify.

### C-rate of discharge curve

Battery manufacturer data sheets typically include a set of curves like the one below that show cell voltage as a function of charge removed for different discharge rates. The "C-rate" is the current used to discharge the battery. It is defined as the current divided by the rated capacity. In this example, if the discharge current is given at the 20-hour discharge rate, the C-rate would be  $I_{20} \div q_{20} \times C = 0.05 \times C$  (C/20).



### Fully charged cell voltage

The voltage at the given C-rate when a cell is at its maximum charge

### Exponential zone cell voltage

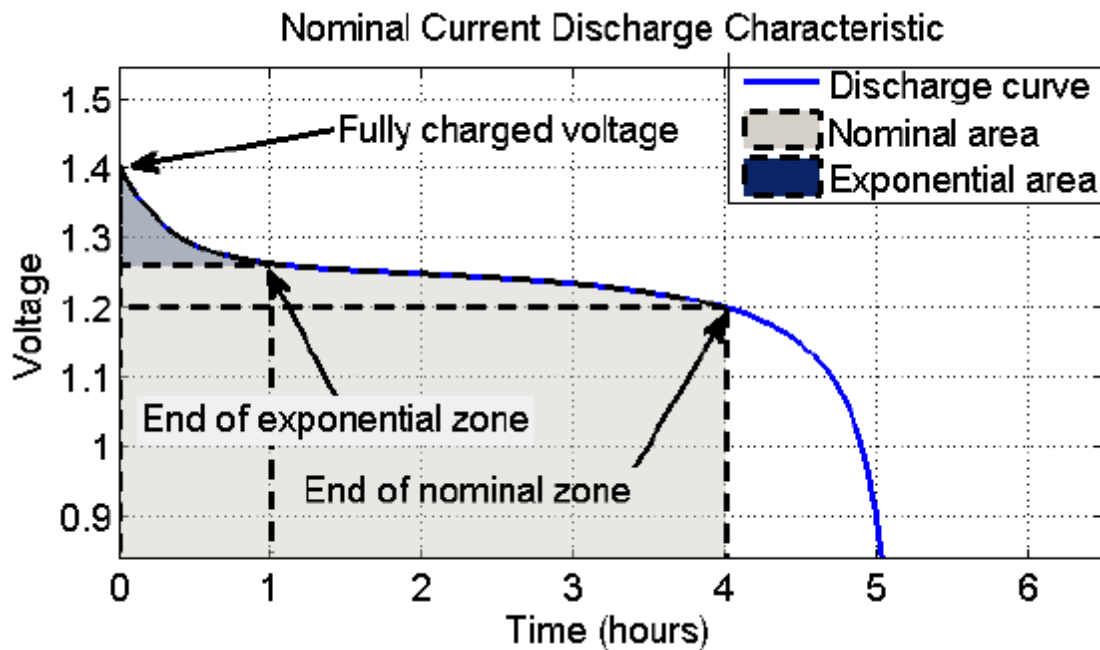
The cell voltage at the end of the exponential zone, as shown in the Nominal Current Discharge Characteristic graph below. The cell charge removed at this point is  $Q_{full} - It$ .

### Nominal zone cell voltage

The cell voltage at the end of the nominal zone, as shown in the Nominal Current Discharge Characteristic graph below. The cell charge removed at this point is  $Q_{full} - It$

### Charge removed at exponential and nominal point

Voltage vs discharge curves show that cell-voltage typically undergoes several distinct regions depending on charge.



### Voltage Table

If you are modeling a flow battery, choose the Voltage Table option and use the table to define the voltage versus depth-of-discharge curve. SAM will update the Voltage Discharge curve to show the data you enter in the table.

#### To use the voltage table to define the voltage curve:

1. Choose **Voltage table**.
2. For **Rows**, type the number of pairs of voltage - depth of discharge pairs you want to use to define the voltage. The table will expand to the number of rows you type.  
You can also click Import to import data from a text file. Try clicking Export to create a template file to see what the text format should be.
3. Type values in the depth of discharge and cell voltage columns. The Voltage Discharge graph will update as you type.

### Battery Losses

Some battery systems have additional losses not captured by the conversion losses in power electronics components above. For these losses, SAM offers the ability to generically specify power losses when the

battery is charging, discharging, or at an idle state. If a detailed loss profile is available, it can be entered as a time series.

## Battery Thermal

The thermal model calculates the battery temperature, which modifies the battery capacity. The system configuration assumes that the battery is stored in a conditioned room at a fixed temperature and is not exposed directly to heat from the sun. The two main heat-transfer terms are transfer between the battery and the room, and internal energy generation via resistive heating. The battery internal resistance input is under "Battery Voltage."

### Thermal Properties

#### Specific heat Cp (J/kg-K)

Estimated specific heat capacity for the battery.

#### Heat transfer coefficient h (W/m<sup>2</sup>-K)

Estimated heat transfer coefficient for heat transfer from the battery to the room.

The default value for behind-the-meter applications is 7.5 W/m<sup>2</sup>-K, and for front-of-meter applications, the default is 15 W/m<sup>2</sup>-K.

#### Room temperature (°C)

Temperature of the room where the battery will be stored. The default value is 25.

### Capacity fade with temperature

The manufacturer data sheet may include battery capacity versus temperature data showing how the battery's capacity decreases with ambient temperature.

#### Temp (°C)

Ambient temperature

#### Capacity (%)

The discharge capacity as a percentage of rated capacity at the given temperature.

### Physical properties

In order to scale battery mass and surface area as the battery bank is sized, properties are entered on a per Watt-hour basis.

#### Specific energy per mass (Wh/kg)

Energy content per unit mass.

#### Surface energy per volume (Wh/L)

Energy content per unit volume.

Given these two properties, SAM calculates the approximate battery length, width, height and mass are computed assuming a cube shape.

### Value of Renewable Energy Macro

For residential and commercial projects, you can use the Value of Renewable Energy [macro](#) to help you make an economic comparison between meeting the building electric load from the grid with no renewable

energy system or battery, the grid with a renewable energy system, and the grid with a renewable energy system and battery. You can use the macro to analyze rate-switching scenarios where the rate structure for the grid-only scenario is different from the one with the renewable energy system.

To run the macro, set up a case for the photovoltaic system with battery, and then click **Macros** (in the lower left corner of the SAM window) and click **Value of RE System** to show the macro. Follow the instructions to choose the appropriate rate structures and run the macro.

Value of RE and Battery for "residential" Case

**Total Electricity Bill in Year 1**

Charge	No System	RE Only	RE+Battery
Energy	\$773	\$0	\$0
Fixed	\$200	\$200	\$200
Demand (fixed)	\$169	\$157	\$66
Demand (TOU)	\$0	\$0	\$0
Monthly minimum	\$0	\$0	\$0
Annual minimum	\$0	\$0	\$0
Year end net metering credit	\$0	\$-75	\$-72
<b>Total bill</b>	<b>\$1,142</b>	<b>\$282</b>	<b>\$194</b>
Savings compared to no system	\$0	\$860	\$947

**Present Value of Annual Costs and Net Present Value**

Present Value	No System	RE Only	RE+Battery
Electricity bill	\$14,942	\$3,831	\$3,379
System costs after tax	\$0	\$6,306	\$8,367
Battery replacement cost	\$0	\$0	\$6,156
<b>Total cost</b>	<b>\$0</b>	<b>\$10,137</b>	<b>\$17,902</b>
NPV of project with bill savings	\$0	\$4,805	\$-2,960

## 9.2 Battery Dispatch BTM

### Charge Limits and Priority

#### Minimum state of charge, %

Sets a limit on the quantity of energy that can be drained from the battery. Battery lifetime is highly dependent on depth of discharge, so this value should be set based on your battery chemistry and desired performance over time. For example a value of 15% would prevent the battery from discharging below a 15% state of charge.

#### Maximum state of charge, %

Sets a limit on the quantity of energy that can be sent to the battery. Battery lifetime is dependent on depth of discharge and state of charge, so this value should be set based on your battery chemistry and desired performance over time. For example a value of 95% would prevent the battery from charging above 95% state of charge.

**Initial state of charge, %**

The state of charge of the battery at the beginning of the simulation. A value of 100% would be for a fully charged battery, 0% would be for a fully discharged battery.

**Minimum time at charge state, min**

This setting only applies to subhourly simulations. You can ignore it for hourly simulations. For sub-hourly simulations, there may be periods of time where the photovoltaic output varies above and below the load causing rapid cycling of the battery. This kind of cycling, especially if the cycles are deep, may degrade battery performance over time. The minimum time at charge state prevents the battery to change between charging and discharging within the number of minutes that you specify.

**Storage Dispatch Controller (Behind the Meter)**

The dispatch controller determines the timing of battery charges and discharges and discharge limits. For behind-the-meter (BTM) systems (Residential, Commercial, or Third Party Financing financial models), you can choose a dispatch option where SAM determines the timing automatically, use the manual dispatch controller to define the timing using hour-by-month weekday and weekend matrices, or input a time series battery power signal.

**Dispatch Options**

Choose the dispatch option that most closely represents how you would like the battery to be charged and discharged.

**Peak Shaving**

The peak shaving options attempt to operate the battery to reduce peak demand over a forecast period, considering the load and solar resource over the period. Use this option to reduce monthly demand charges when the rates on the [Electricity Rates](#) page include demand rates.

**Peak-shaving one-day look ahead**

For each day, dispatch the battery based on the solar resource and load data over the next 24 hours. The look-ahead option is based on a perfect prediction of the future load and solar resource data.

**Peak shaving one-day look behind**

Similar to the one-day look ahead option, but based on the previous 24 hours of solar resource and load data for the prediction. The look-behind option adds some uncertainty to the dispatch because the prediction of the solar resource and load is based on previous day's load and solar resource.

**Input grid power targets**

The grid power target option attempts to operate the battery in response to grid power targets that you specify. In each time step, the controller compares the electric load to the power target, charges the battery when the load is less than the target, and discharges when the load is greater than the target. You can specify a constant annual target, twelve constant monthly targets, or a target for each time step.

Choose **Input grid power targets**, and then choose either **Monthly power targets** or **Time series power targets**:



### Monthly power targets

Choose this option to specify a either a single grid power target for the entire year, or a grid power target for each month. For **Monthly grid power targets**, Click **Edit values** to specify the targets. To apply a single target to the entire year, enter the target as a single value in the Edit Values window and click **Apply**.

### Time series power targets

Choose this option to enter a grid power target for each time step in the simulation. For **Time series grid power targets**, click **Edit array** to specify the targets.

## Input battery power targets

The battery power targets option operates the battery in response to battery power targets you specify. In each time step, the controller attempts to charge to the negative power value you enter, or discharge to the positive power value you enter.

Choose **Input battery power** targets, and then enter the battery power target data.

### Time series battery power targets

Click **Edit array** and import or copy and paste an array of battery power values in kW, where discharge power is positive, charge power is negative. The array must have the same number of rows as simulation time steps: For hourly simulations, 8,760 rows, for 15-minute simulations 35,040 rows, etc.

## Manual dispatch

For the manual dispatch option, you specify the timing of battery charges and discharges using up to six dispatch periods and a set of weekday and weekend hourly profiles by month under **Manual Dispatch**.

The manual dispatch controller assumes that the system meets the electric load before charging the battery. For any time step with "charge from system" allowed, the system charges the battery with any power in excess of the load.

## Price signal forecast

The price signal forecast option operates the battery to minimize the electricity bill over the next 24 hours by considering the load, system power output, and electricity rates. It uses the cycle degradation penalty to consider the cost of future battery replacements.

Choose **Price signal forecast**, and then choose a cycle degradation penalty method and assign a penalty if needed.

### Cycle degradation penalty method

For the price signal forecast option, choose a method for estimating the cost of cycling the battery: Choose **Calculate automatically** if you want SAM to calculate the cost, or choose **Enter penalty** to enter a cost per cycle-kWh value.

If you choose the "calculate automatically" option, SAM reports the calculated penalty as **Computed cycle degradation penalty** in the [battery time series results](#).

### Cycle degradation penalty

The penalty in \$/cycle-kWh of battery total capacity for cycling the battery. You can either enter a single value, or click the blue "val/sched" button to enter a different penalty for each year of the analysis period.



## Charge Options

For the dispatch options except manual dispatch, choose whether the battery can charge from the grid, from the system, or both. For the manual dispatch option, use manual dispatch inputs to specify how the battery is charged.

### Battery can charge from grid

Allow power from the grid to charge the battery.

### Battery can charge from system

Allow power from the power system to charge the battery.

## Manual Dispatch Model

The manual dispatch option allows you to manually specify the timing of battery charges and discharges. Choose the **Manual dispatch** option under **Dispatch Options** to make the manual dispatch inputs active.

You can specify how you want to charge the battery (from grid or system), and whether to allow battery discharging for up to six periods. Use the weekday and weekend schedules to specify the hour of day and month of year that each period applies.

### Charge from system

For each period that you want to allow the battery to be charged by power from the system, check the box in the **Charge from system** column.

### Charge from grid

For each period that you want to allow the battery to be charged by power from the grid, check the box in the **Allow** column, and specify the percentage of the battery's state of charge that can be charged from the grid over the time step.

For example, for hourly simulations, a value of 25% would allow the grid to deliver 25% of the battery state of charge at the beginning of the hour over the hour. The purpose of the percentage is to prevent the battery from being charged too quickly. See the example below under **Discharge** for more details.

**Note.** For subhourly simulations, the charge and discharge percentages apply to the subhourly time step even though the periods are defined in hours.

For a behind-the-meter application, if **Charge from grid** and **Charge from system** are both checked for a given period, and if in a time step in that period the system power is greater than the [load](#), power from the grid will supplement the system power to meet the battery charge requirement.

If **Charge from grid** and **Allow discharging** are both checked for a given period, and if in a time step in that period the battery state of charge is above the minimum state of charge, the battery discharges until it reaches the minimum state of charge, at which point it starts charging from the grid, either until it reaches the maximum state of charge, or until the time period changes to one that does not allow charging from the grid.

### Discharge

For each period that you want to allow the battery to discharge, check the box in the **Allow** column, and specify the percentage of the battery's available charge that can be dispatched over the time step. The available charge is defined by the minimum and maximum state of charge values under **Charge Limits and Priority**.

For example, if Period 3 is the four consecutive hours between 3 pm and 6 pm, the discharge capacity

is 25%, and the charge limits are 30% and 96%, for an hourly simulation, that would allow up to 25% of the charge the battery holds at the beginning of the 3 pm hour to be discharged over the hour. For the 4 pm hour, 25% of the charge at the end of the 3 pm hour would be available, and so on until the end of Period 3. The 25% value would discharge the battery over the full four-hour period. (A 20% value would have the same effect for a 5-hour period, i.e., if Period 3 were between 3 pm and 7 pm.)

For a one-minute simulation, a capacity to discharge of 25% would allow up to 25% of the available charge to be dispatched *every minute* over Period 3, so a smaller percentage would be required to allow the battery to discharge over the full four-hour period.

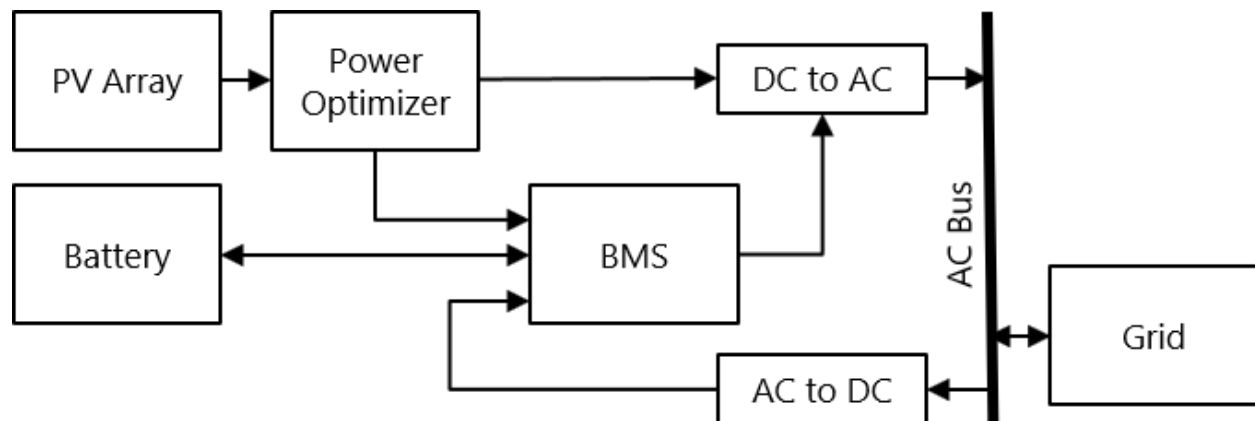
### Weekday and Weekend Schedules

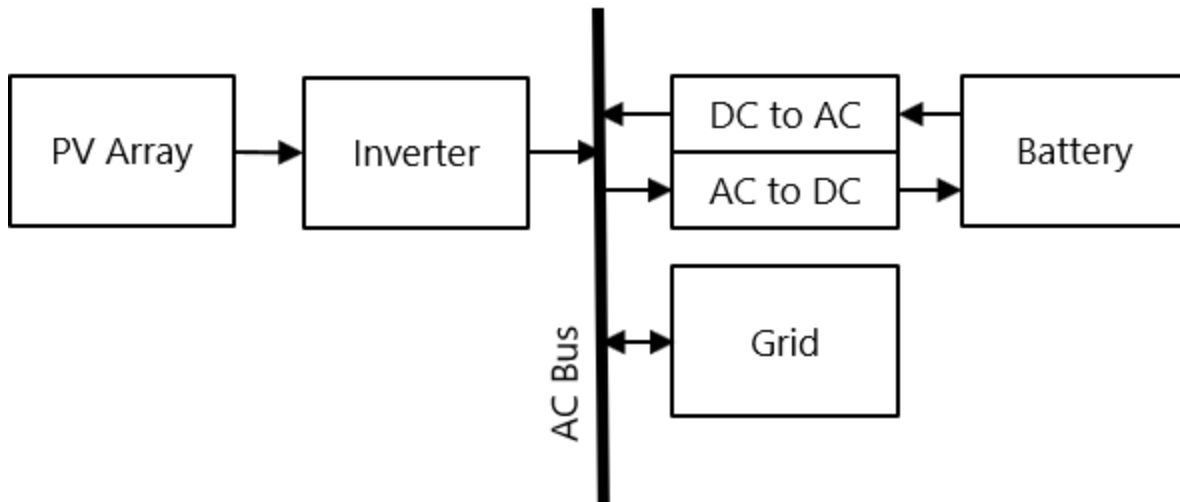
To define the hour of day and month of year that each period applies, use your mouse to select a rectangle in the schedule matrix, and use your keyboard to type the period number (1-6). The number you type should appear in the rectangle.

See [Weekday-weekend Schedules](#) for a step-by-step description of how to use the schedule matrices.

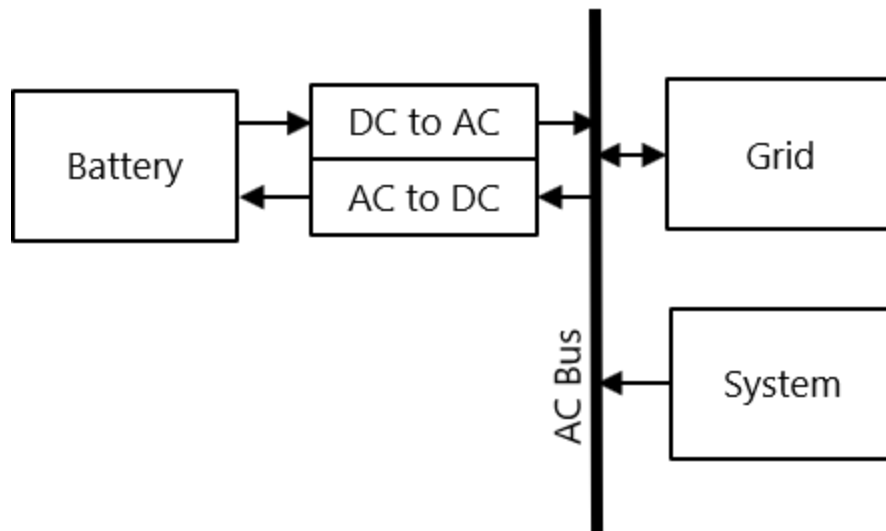
## 9.3 Front of Meter (FOM)

The front-of-meter (FOM) battery model assumes that the battery is used to maximize revenue for a power generation project. The battery in a PV-battery front-of-meter application may be connected either to the AC or DC side of the inverter as shown in Figures 1 and 2.



**Figure 1: PV-battery DC-connected Front-of-meter****Figure 2: PV-battery AC-connected Front-of-meter**

The battery in a generic front-of-meter application is connected to the AC side of the system as shown in Figure 3.

**Figure 3: Generic-battery AC-connected Front-of-meter**

## Chemistry

The battery type defines the battery chemistry for (lithium ion, lead acid, or flow battery), and the type of battery for each chemistry. When you choose a battery type, SAM automatically changes the battery

property input variables to default values for that type. These default values were drawn from DiOrio (2015) "Technoeconomic Modeling of Battery Energy Storage in SAM" cited above, which also includes more details on how SAM calculates battery capacity.

### Battery type

Choose the battery chemistry and battery type for the batteries in your system.

When you choose a battery type, SAM replaces the values of **Voltage Properties** and **Current and Capacity** input variables as appropriate with values for each battery type.

When you choose a custom battery type for either the lead acid or lithium ion chemistry, SAM does not replace the input variable values.

#### Notes.

To model a battery type not included in the list, choose either **Lead Acid: Custom** or **Lithium Ion: Custom**, and specify your voltage, current, and capacity properties appropriate for the battery.

When you choose the custom lead acid battery type, SAM retains the capacity and discharge rate values from the table below from the previous state. For example, if you change the battery type from flooded lead acid to custom lead acid, SAM will apply the capacity/discharge rate table for flooded batteries to your custom battery.

### Lead Acid

The three lead acid battery types use the lead acid battery capacity model described in DiOrio (2015), cited above:

- Flooded lead acid batteries with a liquid electrolyte.
- Valve Regulated (VRLA) batteries are sealed, and the electrolyte is bound in a gel.
- VRLA Absorptive Glass Mat (AGM) batteries are sealed, and the electrolyte is immobilized in porous separators.

Lead acid battery capacity is dependent on the discharge rate. When you choose different lead-acid battery types from the list, SAM changes internal variable values that define the relationship between capacity and discharge rate as shown in the table below. It is not possible to change these values from the Battery Storage input page. These values are based on analysis of information for batteries from different manufacturers. SAM considers the 20-hour discharge rate to be the nominal capacity of a lead-acid battery and scales the capacity at faster discharge rates as a percent of the that 20-hour capacity.

Discharge Rate	Capacity %		
	Flooded	VRLA Gel	VRLA AGM
20-hr ( 0.05 C )	100	100	100
10-hr ( 0.1C )	87	84.9	93.2
1-hr ( C )	47	63.1	58.1

### Lithium Ion

The six lithium ion battery types use of the lithium-ion battery capacity model described in DiOrio (2015) "Technoeconomic Modeling of Battery Energy Storage in SAM" cited above:

- LMO: Lithium Manganese Oxide ( $LiMn_2O_4$ ) – An inexpensive high-voltage cathode material with high power capabilities but potentially lower lifespan.
- LFP: Lithium Iron Phosphate ( $LiFePO_4$ ) – A lower voltage cathode material with excellent safety properties but lower volumetric energy.
- LCO: Lithium Cobalt Oxide ( $LiCoO_2$ ) – Among the first and still a common cathode material with high specific energy, but potentially costly and toxic.
- LTO: Lithium Titanate ( $Li_4Ti_5O_{12}$ ) – A promising anode material with excellent lifetime properties but lower specific capacity and important cost considerations.
- NMC: Nickel Manganese Cobalt ( $LiNiMnCoO_2$ ) – A less expensive cathode material than LCO with potentially improved safety characteristics
- NCA: Nickel Cobalt Aluminum ( $LiNiCoAlO_2$ ) – Similar in respects to NMC as a cathode material with high specific energy

When you choose a lithium ion battery, SAM assigns values to voltage, lifetime, and thermal properties as appropriate from Reddy (2011), cited above, and from manufacturer data sheets. SAM does not change any internal variables or calculations.

## Flow Batteries

Flow battery designers can decouple power output (kW) from energy capacity (kWh) when sizing systems. Flow batteries may be able to cycle more deeply and operate for more total cycles than lithium ion or lead acid batteries, but flow batteries also have pumps, which should be considered when calculating **Ancillary Equipment Losses**.

### Vanadium Redox Flow

The vanadium redox flow battery model available in SAM comes from R. D'Agostino et. al, (2014) "A Vanadium-Redox Flow-Battery Model for Evaluation of Distributed Storage Implementation in Residential Energy Systems"

- VRFB: Vanadium Redox Flow ( $V^{2+}, V^{3+}$  anolyte), ( $VO^{2+}, VO^{2+}$ , catholyte)

### All Iron Redox Flow

The all iron redox flow battery model available in SAM shares the same input field framework as the vanadium flow battery, but relies on tabular voltage vs. depth-of-discharge in place of a voltage model. Default iron flow battery values are based on preliminary manufacturer data and feedback for an all-iron hybrid-redox flow battery.

- AIFB: All Iron Redox Flow ( $Fe^{2+}, Fe^{3+}$ )

## Battery Bank Sizing

The two battery bank sizing options allow you to either automatically size the battery bank based on desired size, or to specify the number of cells and their configuration in the bank yourself. The automatic option is suitable for an initial preliminary design. It uses the basic equations described below to determine numbers of cells and strings or stacks, but does not take into account real-life design considerations that are outside of the model's scope. If you use the automatic sizing option, you should refine the bank sizing parameters by specifying your own values after analyzing the initial results.

### Set desired bank size

Choose this option to have SAM calculate a number of cells in series and strings in parallel based on

the desired bank capacity and power values you enter.

If you choose this option, be sure to verify the values under Computed Properties to make sure SAM was able to calculate values close to the desired values.

### Specify cells

Choose this option to manually specify the number of cells in series, strings in parallel and C-rates of charge and discharge.

### Desired bank capacity, kWh

For the Set desired bank size option, the size of the battery bank in kWh. Compare this to the Nominal bank capacity under Computed Properties to verify that SAM calculated a nominal value close enough to the desired value to meet your requirements.

### Desired bank power, kW

For the Set desired bank size option, the maximum discharge rate in kW. Compare this to the Maximum discharge power under Computed Properties to verify that SAM calculated a discharge power close enough to the desired value to meet your requirements.

### Number of cells in series

For the Number of cells in series option, the number of cells in series in the battery bank. The number of cells in series determines the maximum discharge power.

### Number of strings in parallel

For the Specify cells option, the number of strings of cells in parallel in the battery bank. The number of strings in parallel determines the nominal bank capacity.

### Max C-rate of charge, 1/hour

### Max C-rate of discharge, 1/hour

## To automatically size the battery bank:

1. Click **Set desired bank size**.
2. Enter values for **Desired bank capacity** in kilowatt-hours and **Desired bank power** in kW. Choose either **DC** or **AC** as appropriate for your battery ratings.
3. The default desired battery bank voltage is depends on the battery chemistry. If you want to change the nominal DC voltage of the battery bank, expand the **Battery Voltage** panel, and change the **Desired bank voltage** in DC Volts under **Voltage Properties**.
4. Under **Computed Properties** in the **Current and Capacity** group, check the **Nominal bank capacity** and **Nominal bank voltage** to make sure they are close enough to your desired values. Also check that **Maximum discharge power (DC)** is close to your desired bank power.

You can estimate the nominal battery bank hours of autonomy by dividing the capacity in kWh by the maximum discharge power in kW, which is shown as **Time at maximum power**.

If you use AC ratings for the capacity and power values, SAM converts them to DC using the **DC to AC conversion efficiency** you specify under **Power Converters**.

See [Calculations for Automatic Bank Sizing](#) for details about how SAM determines the bank size based on the values you enter.

## To manually size the battery bank for conventional batteries:

1. Click **Specify cells**.
2. Enter values for **Number of cells in series** and **Number of strings in parallel**.

3. Enter values for **Max C-rate of charge** and **Max C-rate of discharge**.

Batteries typically have some limits based on chemistry for how much power can be input during charging or extracted during discharging. The C-rate is the current divided by the nominal capacity at that current. A one-hour discharge rate is 1C, whereas a half-hour rate is 2C and a two-hour rate is 0.5C. If this value is reported on a battery data sheet in units of power, then calculate the C-rate either as:

$$C = P \div (V \times Q)$$

$$C = P \div E$$

Where,

$P$  = power limit in units of W

$V$  = the nominal voltage of the battery bank in V

$Q$  = nominal charge of battery bank in Ah

$E$  = nominal bank capacity in Wh

SAM's battery thermal model also considers current flow as a primary mechanism for battery heating. Reducing the maximum current charge and discharge is one way to reduce thermal losses and improve battery efficiency.

4. Use the values under **Computed Properties** in the **Current and Capacity** section to check your design.

#### **To manually size the battery bank for flow batteries:**

1. Click **Specify capacity and stack configuration**. If you do not see this option, be sure to choose a flow battery from the **Battery type** list under **Chemistry**.
2. Enter values for **Number of cells per stack**.
3. Enter values for **Number of parallel stacks** and **Number of stacks in series**.
4. Enter a value for the **Bank capacity in kWh**.
5. Use the values under **Computed Properties** to check your design.

**Note.** Since the capacity and power of a flow battery are decoupled, the C-rate is a computed byproduct of the configuration rather than an input design constraint.

### **Calculations for Automatic Bank Sizing**

SAM's bank sizing calculations use basic equations using the cell property information you specify. The calculated values are designed to help you get started with your system design. They do not account for many real-life design factors. You should use these values for an initial preliminary analysis and then use **Specify cells** for conventional batteries or **Specify capacity and stack configuration** for flow batteries to refine your analysis.

#### **Number of cells in series, Number of cells per stack**

SAM calculates a number of cells in series for a conventional battery, or cells per stack for a flow battery assuming one stack, that either meets exactly or slightly exceeds the desired bank voltage based on the cell nominal voltage. For example, for a desired bank voltage of 24 V with a nominal cell voltage of 3.6 V, SAM calculates  $24 \text{ V} \div 3.6 \text{ V/cell} = 6.7$ , or 7 cells in series. The actual nominal bank voltage is  $3.6 \text{ V/cell} \times 7 \text{ cells} = 25.2 \text{ V}$ . SAM displays the actual battery bank properties as calculated values under Current and Capacity.

### Number Strings in parallel (Lithium ion, lead-acid)

SAM calculates the bank capacity by determining the number of strings of cells in parallel required to ensure that the actual capacity is as close as possible to the desired value given the cell capacity that you specify under **Current and Capacity**. For the example above, if the desired bank capacity is 3 kWh, and the cell capacity is 1.5 Ah, the calculated bank voltage would be 25.2 V, and one string of cells has a capacity of  $25.2\text{ V} \times 1.5\text{ Ah} = 37.8\text{ Wh}$ , or 0.0378 kWh. To reach the desired bank capacity of 3 kWh:  $3\text{ kWh} \div 0.0378\text{ kWh/string} = 79.4$ , or 80 strings.

The calculated C-rates of charge and discharge are the desired bank power divided by the computed bank capacity.

### Capacity and Stack Configuration (Vanadium redox flow, all iron redox flow)

For flow batteries, the capacity is independent of the power block and can be specified exactly by the amount of electrolyte in the tanks. SAM sets nominal bank capacity to the desired capacity you specify. SAM calculates the nominal power ratings using the desired stack (bank) voltage and other properties in the **Current and Capacity** group. The number of stacks in parallel is depends on whether the cells are power limited or current limited.

For the **Power limited** option, the number of stacks in parallel is the ceiling of the desired bank power divided by the product of **Cell max power discharge** and the number of cells in the stack (assuming one stack in series). For example, consider a flow battery with a desired bank capacity of 100 kWh, bank power of 50 kW, and bank voltage of 48V with 1.4V cells and a cell power discharge max of 2W. The number of cells in the stack is  $\text{ceiling}(48\text{V} \div 1.4\text{V/cell}) = \text{ceiling}(34.2\text{ cells}) = 35\text{ cells}$ . The bank voltage is  $35\text{ cells} \times 1.4\text{V/cell} = 49\text{V}$ . To achieve 50KW with limitations of 2W/cell, there must be  $\text{ceiling}(50\text{ kW} / (0.002\text{ kW/cell} * 35\text{ cells})) = 715\text{ stacks in parallel}$ .

For the **Current limited** option, the number of stacks in parallel is the ceiling of the desired bank power divided by the product of the battery bank voltage and **Cell max current discharge**. In the example above, if all properties are the same except the battery is current limited with 10A per cell (and consequently per stack), the number of stacks in parallel must be:  $\text{ceiling}(50\text{ kW} / (49\text{V} * 10\text{ A} * 0.001)) = 103\text{ stacks in parallel}$ .

For the **Limit both current and power** option, the stacks are sized by using the current limit, and within the model at each time step the current and power through the cells are checked and reduced if necessary.

## Current and Capacity

The Current and Capacity parameters depend on the battery chemistry:

- For lead acid and Lithium-ion batteries, you specify a cell capacity value, and SAM displays the computed properties based on the battery bank sizing parameters.
- For flow batteries, you choose whether the battery is power- or current-limited and specify minimum and maximum rates.

## Lead Acid and Lithium-ion Battery Parameters

### Cell capacity

The capacity of a single cell when the battery is fully charged. SAM sets this value to a default value when you choose a battery chemistry, but you can change its value.

## Flow Battery Parameters



**Power limited with Cell max power charge and discharge**

Limit the maximum charge and discharge power.

**Current limited with Cell max current charge and discharge**

Limit the maximum charge and discharge current.

**Limit both current and power**

Limit both the charge limits by both power and current.

**Computed Properties**

These are the values that SAM uses for simulation. The values may either be ones that you specify or that SAM calculates, depending on whether you choose the **Set desired bank size** or **Specify cells** option.

**Nominal bank capacity**

The product of total number of cells and cell capacity.

**Nominal bank voltage**

The product of number of cells in series and the cell nominal voltage as specified under **Bank Voltage**.

**Cells in series / Cells per stack**

The number of battery cells in series in each string of cells, which determines the battery bank voltage. Either the value you specify explicitly, or that SAM calculates as described above.

**Strings in parallel / Stacks in parallel**

The number of parallel strings of battery cells, determines the battery bank capacity. Either the value you specify explicitly, or that SAM calculates as described above.

**Stacks in series**

For flow batteries, the number of stacks in series.

**Max C-rate of discharge**

Either calculated from  $\text{Maximum Discharge Power} \div \text{Nominal Bank Capacity}$ , or user input.

**Max C-rate of charge**

Either calculated from  $\text{Maximum Charge Power} \div \text{Nominal Bank Capacity}$ , or user input.

**Maximum discharge power, DC kW**

The maximum discharge power, calculated from the nominal bank capacity and maximum C-rate of discharge. This is also the nominal DC power of the battery bank.

**Maximum charge power, DC kW**

The maximum charge power, calculated from the nominal bank capacity and maximum C-rate of charge.

**Maximum discharge power, AC kW**

The maximum discharge power, calculated from the nominal bank capacity, maximum C-rate of discharge, and DC to AC conversion efficiency.

**Maximum charge power, AC kW**

The maximum discharge power, calculated from the nominal bank capacity, maximum C-rate of charge, and DC to AC conversion efficiency..

**Time at maximum power**

The nominal bank capacity divided by the maximum power, or 1 divided by the maximum C-rate of discharge.

**Maximum discharge current**

Calculated from the maximum C-rate of discharge: Max Discharge Current =  $1000 \times \text{Max C-rate of Discharge} \times \text{Nominal Bank Capacity} \div \text{Nominal Bank Voltage}$ .

**Maximum charge current**

Calculated from the maximum C-rate of charge: Maximum Charge Current =  $1000 \times \text{Maximum C-rate of Charge} \times \text{Nominal Bank Capacity} \div \text{Nominal Bank Voltage}$ .

**Power Converters**

For photovoltaic-battery systems, SAM can model a battery that is connected to either the DC or AC side of the photovoltaic inverter.

**Notes.**

The Power Converters inputs are only available with the PV Battery configuration. They are not available with the Generic Battery configuration, which assumes that the battery is the only DC component in the system.

The Power Converters inputs account for electrical losses associated with converting between DC and AC power for the batteries in the system. For all power converters except the photovoltaic inverter, SAM models the converter performance using the fixed conversion efficiency values you provide.

The photovoltaic inverter is a separate component from the power converter equipment specified here and uses a more sophisticated model with an efficiency curve that varies with the inverter load. You specify the photovoltaic inverter model and parameters on the [Inverter](#) page.

**DC Connected**

Choose the DC Connected option for a battery connected to the DC side of the photovoltaic inverter through a battery management system (BMS) so that the same inverter converts DC power from the BMS and photovoltaic array to AC power. This configuration also requires a DC power optimizer or DC/DC converter to connect the photovoltaic array to the BMS and inverter as shown in the diagram above.

To account for electrical losses from the DC power optimizer, be sure to assign an appropriate value to the **DC power optimizer loss** on the [Losses](#) page.

For a DC-connected battery, during time steps when the total power from the photovoltaic array and battery is greater than the inverter's nameplate capacity, the inverter limits its output power to the nameplate capacity. For the automated dispatch options with **Battery can charge from clipped system power** enabled, if the battery is not fully charged and is not discharging, the excess power from the array charges the battery.

**DC to DC conversion efficiency, %**

For the DC-connected option, the electrical conversion efficiency of the battery management system (BMS). SAM applies this loss to power into or out of the battery BMS as energy enters and leaves the battery. SAM disables this input for the AC Connected option.

**Inverter efficiency cutoff, %**

For the DC-connected option, the inverter efficiency cutoff is an inverter efficiency threshold below which the battery is not allowed to charge or discharge through the inverter.

**AC Connected**

Choose the AC-connected option for a battery connected to the system between the inverter and grid interconnection point. Power conversion equipment is required to convert DC power from the battery to AC power before it can serve the load or be sent to the grid, and to convert AC power from the inverter or grid before it can charge the battery.

**AC to DC conversion efficiency, %**

For the AC-connected option, the electrical conversion efficiency associated with the equipment that converts the AC power from either the photovoltaic inverter or grid to DC power for the battery. SAM disables this input for the DC Connected option.

**DC to AC conversion efficiency, %**

For the AC-connected option, the electrical conversion efficiency associated with the equipment that converts the DC power from the battery to AC power for either the AC load or grid, or both. SAM disables this input for the DC Connected option.

**Charge Limits and Priority****Minimum state of charge, %**

Sets a limit on the quantity of energy that can be drained from the battery. Battery lifetime is highly dependent on depth of discharge, so this value should be set based on your battery chemistry and desired performance over time. For example a value of 15% would prevent the battery from discharging below a 15% state of charge.

**Maximum state of charge, %**

Sets a limit on the quantity of energy that can be sent to the battery. Battery lifetime is dependent on depth of discharge and state of charge, so this value should be set based on your battery chemistry and desired performance over time. For example a value of 95% would prevent the battery from charging above 95% state of charge.

**Initial state of charge, %**

The state of charge of the battery at the beginning of the simulation. A value of 100% would be for a fully charged battery, 0% would be for a fully discharged battery.

**Minimum time at charge state, min**

This setting only applies to subhourly simulations. You can ignore it for hourly simulations. For sub-hourly simulations, there may be periods of time where the photovoltaic output varies above and below the load causing rapid cycling of the battery. This kind of cycling, especially if the cycles are deep, may degrade battery performance over time. The minimum time at charge state prevents the battery to change between charging and discharging within the number of minutes that you specify.

**Battery Lifetime**

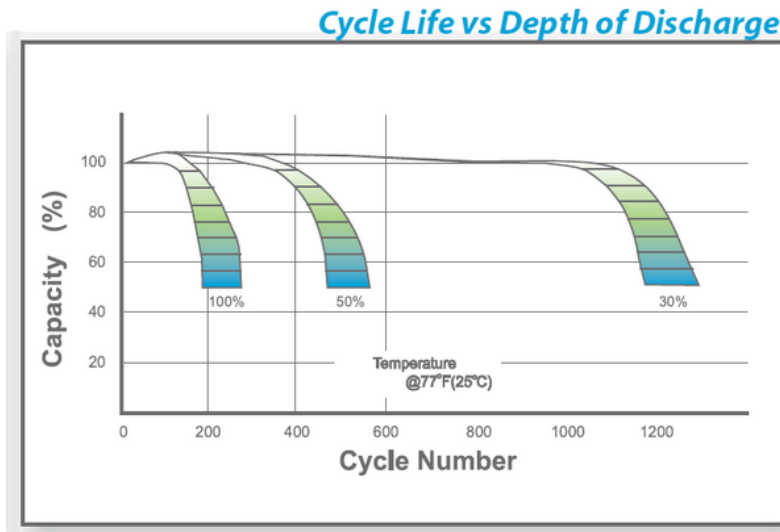
SAM's battery lifetime model considers battery cycling and age as the primary causes of capacity degradation.

**Cycle Degradation**

Cycle degradation is a reduction in the battery's capacity at 100% charge as the battery is charged and discharged. The cycle degradation model relies on information about capacity fade at the number of cycles elapsed at an average depth of discharge. If you enter your own cycle degradation data, you should enter at least two or three sets of data for two or three different depths of discharge.

You must provide at least three rows of data. For a table with more than one depth-of-discharge value, SAM uses bilinear interpolation to consider both the average depth-of-discharge and cycle number when applying the capacity fade. If the table contains data for a single depth-of-discharge value, then SAM only considers the cycle number in the capacity fade calculation using a rainflow counting algorithm.

For example, given the following graph from a battery's datasheet:



You might enter the following data in the table:

**Battery Lifetime**

Import...	Depth-of-discharge (%)	Cycles Elapsed	Capacity (%)
Export...	30	0	100
Copy	30	1100	90
Paste	30	1200	50
	50	0	100
	50	400	90
	50	500	50
Rows:	100	0	100
	100	100	90
	100	150	50

The graph shows Effective capacity (%) on the y-axis (0 to 100) and Cycle number on the x-axis (0 to 1200). Three lines represent different DoD values: 30% (blue), 50% (green), and 100% (red). The 100% DoD line drops sharply to 50% capacity at 200 cycles. The 50% DoD line drops to 50% capacity at 400 cycles. The 30% DoD line remains near 100% capacity until 1100 cycles, then drops to 50% at 1200 cycles.

Some battery data sheets do not report this kind of information. For these batteries, you can use the default values in the table.

### Calendar Degradation

Calendar degradation is a reduction in capacity over a battery's life that occurs over time. This degradation may be a function of time, temperature and state of charge, or simply a function of time.

### Lithium-ion model

The Lithium-ion model accounts for how a Lithium-ion battery's capacity degrades with time, temperature, and state-of-charge. For a description of the model, see Smith, K.; Saxon, A.; Keyser, M.; Lundstrom, B.; Cao, Z.; Roc, A. (2017). [Life Prediction Model for Grid-Connected Li-ion Battery Energy Storage System](#). 7 pp. 2017 American Control Conference, Seattle, USA.

**Calendar Degradation**  
 None     Lithium-ion model     Enter custom

**Lithium-ion Model**  
 $q = q_0 - k_{cal} * \sqrt{t}$   
 $k_{cal} = a * \exp[b(1/T - 1/296)] * \exp[c(SOC/T - 1/296)]$   
 $q_0$   fraction     $a$   1/sqrt(day)  
 $b$   K     $c$   K

**Custom Degradation**

Battery age (days)	Capacity (%)
0	100
3650	80
7300	50

Rows:

### Custom degradation

The custom degradation option allows you to enter your own degradation curve. To enter the curve, click **Custom degradation**, and for **Rows**, type the number of capacity as % of nominal full capacity and battery age in days data points on your degradation curve. Then type the values in the table, and check the curve for the correct shape.

**Calendar Degradation**  
 None     Lithium-ion model     Custom degradation

**Lithium-ion Model**  
 $q = q_0 - k_{cal} * \sqrt{t}$   
 $k_{cal} = a * \exp[b(1/T - 1/296)] * \exp[c(SOC/T - 1/296)]$   
 $q_0$   fraction     $a$   1/sqrt(day)  
 $b$   K     $c$   K

**Custom Degradation**

Battery age (days)	Capacity (%)
0	100
3650	80
7300	50

Rows:

### Battery Replacements

Battery degradation as a reduction in available storage capacity over time caused by battery cycling (charge and discharge cycles) and age. If you model battery replacements, SAM calculates an annual replacement cost in the project cash flow based on the replacement options specified here and the replacement cost

on the System Costs page.

### No replacements

Use this option if you do not want to account for battery replacement costs, or if you want to account for them using one of the Operation and Maintenance cost categories on the [System Costs](#) page.

If you choose the No replacements option, SAM operates the system with no battery after the available storage capacity is depleted.

### Replace at specified capacity

Use this option if you want SAM to calculate the year(s) in which batteries are replaced based on degradation of the battery's capacity caused by battery cycling as determined from the **Battery Lifetime** parameters.

Set **Battery bank replacement threshold** as percentage of the battery's rated capacity that triggers a replacement. When the battery's available capacity has degraded to this percentage, SAM replaces the battery and applies the battery replacement cost from the [System Costs](#) page to the project [cash flow](#). If you set the threshold to less than 2%, SAM sets the value internally to 2% to avoid simulation issues as the battery's available capacity approaches 0% of its original capacity.

### Replace at specified schedule

Use this option to specify the years when batteries are replaced and the percent of battery capacity that is replaced in those years.

Use the **Battery bank replacement schedule** option to force all batteries to be replaced in a given year or years, regardless of degradation. Click **Edit array** to specify the percentage of total battery capacity to be replaced in each replacement year. In the Edit Array window, click **Number of values**, and enter the analysis period from the [Financial Parameters](#) input page. Then in the table, type a percentage for each year in which the batteries will be replaced. The rows for the remaining years should be zero.

## Battery Voltage

The voltage properties are technical specifications available on most battery manufacturer data sheets.

Battery voltage varies with state of charge as the internal open circuit potential decreases or increases. When a battery charges, positive ions travel from the cathode to the anode, lowering the open circuit potential of the anode and increasing the open circuit potential of the cathode, resulting in a net increase of potential between the anode and cathode. Similarly, as a battery discharges, ions flow back from the anode to the cathode, reducing the net potential. Battery manufacturer data sheets typically report a voltage-discharge curve of some kind to illustrate this behavior. SAM uses a dynamic voltage model, which specifies how to extract information from a data sheet to populate the voltage discharge curve.

Voltage variations in charging and discharging affect the battery's round-trip efficiency. During charging, voltage increases, requiring more power to charge the cell. During discharge the voltage decreases and less power can be extracted. The round-trip efficiency is computed as the net amount of energy discharged from a cell divided by how much energy it took to charge the cell.

## Voltage Properties Common to All Chemistries

The following voltage properties are available for all of the battery chemistry options.

### Desired bank voltage

The battery bank voltage you are trying to achieve in your design. SAM calculates the number of cells in series based on the desired bank voltage and cell nominal voltage:

*Number of Cells in Series = ROUND UP ( Desired Bank Voltage ÷ Cell Nominal Voltage )*

### Cell nominal voltage

The reference voltage of a single, fully charged cell in the battery as reported by the manufacturer. The typical nominal voltage for a lead acid cell is 2 V, and for lithium ion cell is 3.7 V.

SAM uses the nominal voltage to size the battery bank and compute the battery bank's nominal voltage.

### Cell Internal resistance

The cell internal resistance for each cell in the battery in Ohms. SAM assumes that this is a constant value and uses it in voltage and thermal calculations by scaling the cell internal resistance to a total battery resistance based on the cell configuration.

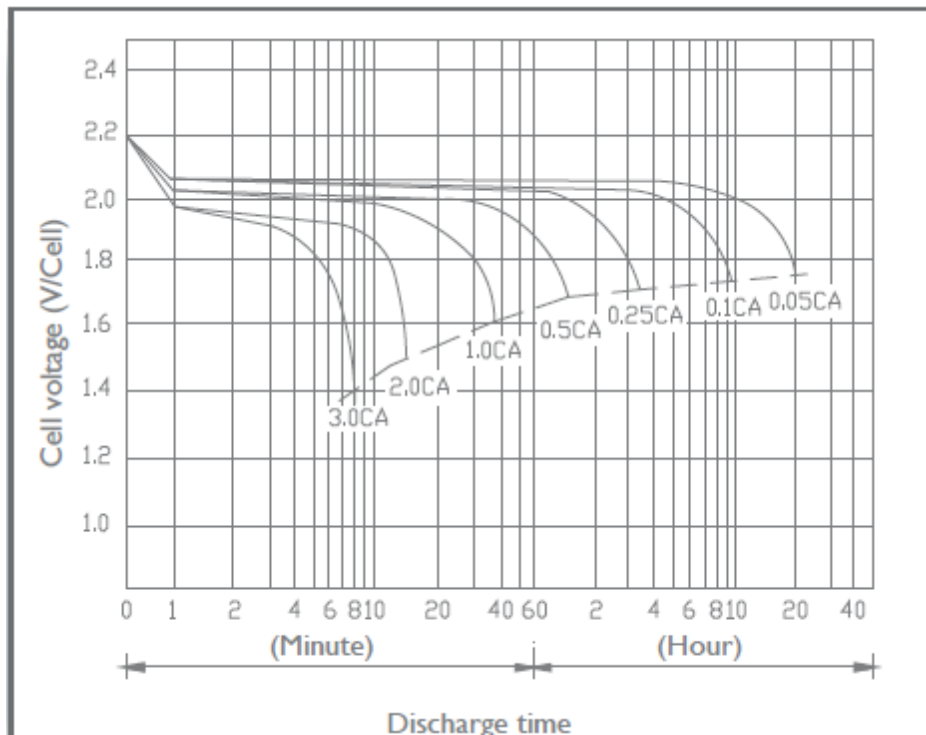
## Electrochemical Properties

The electrochemical model properties apply to the lead acid and Lithium-ion battery types. They are disabled for the flow battery types.

SAM displays the Voltage Discharge graph based on the electrochemical properties you specify.

### C-rate of discharge curve

Battery manufacturer data sheets typically include a set of curves like the one below that show cell voltage as a function of charge removed for different discharge rates. The "C-rate" is the current used to discharge the battery. It is defined as the current divided by the rated capacity. In this example, if the discharge current is given at the 20-hour discharge rate, the C-rate would be  $I_{20} \div q_{20} \times C = 0.05 \times C$  (C/20).



### Fully charged cell voltage

The voltage at the given C-rate when a cell is at its maximum charge

### Exponential zone cell voltage

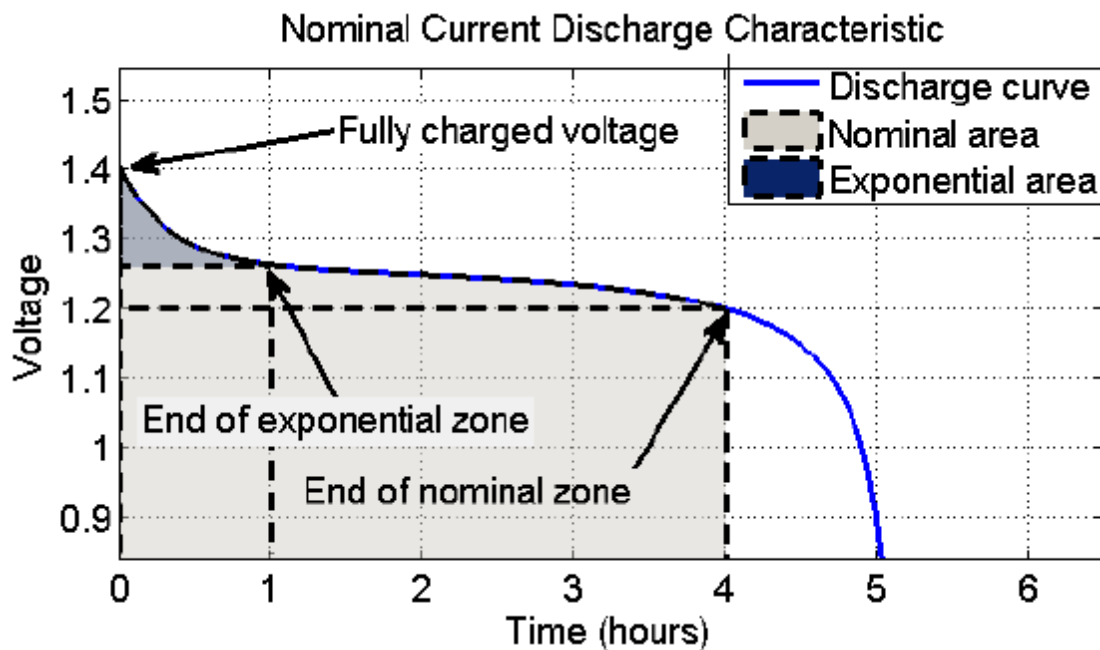
The cell voltage at the end of the exponential zone, as shown in the Nominal Current Discharge Characteristic graph below. The cell charge removed at this point is  $Q_{full} - It$ .

### Nominal zone cell voltage

The cell voltage at the end of the nominal zone, as shown in the Nominal Current Discharge Characteristic graph below. The cell charge removed at this point is  $Q_{full} - It$ .

### Charge removed at exponential and nominal point

Voltage vs discharge curves show that cell-voltage typically undergoes several distinct regions depending on charge.



### Voltage Table

If you are modeling a flow battery, choose the Voltage Table option and use the table to define the voltage versus depth-of-discharge curve. SAM will update the Voltage Discharge curve to show the data you enter in the table.

#### To use the voltage table to define the voltage curve:

1. Choose **Voltage table**.
2. For **Rows**, type the number of pairs of voltage - depth of discharge pairs you want to use to define the voltage. The table will expand to the number of rows you type.  
You can also click Import to import data from a text file. Try clicking Export to create a template file to see what the text format should be.
3. Type values in the depth of discharge and cell voltage columns. The Voltage Discharge graph will update as you type.



## Battery Losses

Some battery systems have additional losses not captured by the conversion losses in power electronics components above. For these losses, SAM offers the ability to generically specify power losses when the battery is charging, discharging, or at an idle state. If a detailed loss profile is available, it can be entered as a time series.

## Battery Thermal

The thermal model calculates the battery temperature, which modifies the battery capacity. The system configuration assumes that the battery is stored in a conditioned room at a fixed temperature and is not exposed directly to heat from the sun. The two main heat-transfer terms are transfer between the battery and the room, and internal energy generation via resistive heating. The battery internal resistance input is under "Battery Voltage."

## Thermal Properties

### Specific heat $C_p$ (J/kg-K)

Estimated specific heat capacity for the battery.

### Heat transfer coefficient $h$ (W/m<sup>2</sup>-K)

Estimated heat transfer coefficient for heat transfer from the battery to the room.

The default value for behind-the-meter applications is 7.5 W/m<sup>2</sup>-K, and for front-of-meter applications, the default is 15 W/m<sup>2</sup>-K.

### Room temperature (°C)

Temperature of the room where the battery will be stored. The default value is 25.

## Capacity fade with temperature

The manufacturer data sheet may include battery capacity versus temperature data showing how the battery's capacity decreases with ambient temperature.

### Temp (°C)

Ambient temperature

### Capacity (%)

The discharge capacity as a percentage of rated capacity at the given temperature.

## Physical properties

In order to scale battery mass and surface area as the battery bank is sized, properties are entered on a per Watt-hour basis.

### Specific energy per mass (Wh/kg)

Energy content per unit mass.

### Surface energy per volume (Wh/L)

Energy content per unit volume.

Given these two properties, SAM calculates the approximate battery length, width, height and mass are computed assuming a cube shape.

## Value of Renewable Energy Macro

For residential and commercial projects, you can use the Value of Renewable Energy [macro](#) to help you make an economic comparison between meeting the building electric load from the grid with no renewable energy system or battery, the grid with a renewable energy system, and the grid with a renewable energy system and battery. You can use the macro to analyze rate-switching scenarios where the rate structure for the grid-only scenario is different from the one with the renewable energy system.

To run the macro, set up a case for the photovoltaic system with battery, and then click **Macros** (in the lower left corner of the SAM window) and click **Value of RE System** to show the macro. Follow the instructions to choose the appropriate rate structures and run the macro.

Value of RE and Battery for "residential" Case

**Total Electricity Bill in Year 1**

Charge	No System	RE Only	RE+Battery
Energy	\$773	\$0	\$0
Fixed	\$200	\$200	\$200
Demand (fixed)	\$169	\$157	\$66
Demand (TOU)	\$0	\$0	\$0
Monthly minimum	\$0	\$0	\$0
Annual minimum	\$0	\$0	\$0
Year end net metering credit	\$0	\$-75	\$-72
<b>Total bill</b>	<b>\$1,142</b>	<b>\$282</b>	<b>\$194</b>
Savings compared to no system	\$0	\$860	\$947

**Present Value of Annual Costs and Net Present Value**

Present Value	No System	RE Only	RE+Battery
Electricity bill	\$14,942	\$3,831	\$3,379
System costs after tax	\$0	\$6,306	\$8,367
Battery replacement cost	\$0	\$0	\$6,156
<b>Total cost</b>	<b>\$0</b>	<b>\$10,137</b>	<b>\$17,902</b>
NPV of project with bill savings	\$0	\$4,805	\$-2,960

## 9.4 Battery Dispatch FOM

### Charge Limits and Priority

#### Minimum state of charge, %

Sets a limit on the quantity of energy that can be drained from the battery. Battery lifetime is highly dependent on depth of discharge, so this value should be set based on your battery chemistry and desired performance over time. For example a value of 15% would prevent the battery from discharging below a 15% state of charge.

#### Maximum state of charge, %

Sets a limit on the quantity of energy that can be sent to the battery. Battery lifetime is dependent on

depth of discharge and state of charge, so this value should be set based on your battery chemistry and desired performance over time. For example a value of 95% would prevent the battery from charging above 95% state of charge.

**Initial state of charge, %**

The state of charge of the battery at the beginning of the simulation. A value of 100% would be for a fully charged battery, 0% would be for a fully discharged battery.

**Minimum time at charge state, min**

This setting only applies to subhourly simulations. You can ignore it for hourly simulations. For sub-hourly simulations, there may be periods of time where the photovoltaic output varies above and below the load causing rapid cycling of the battery. This kind of cycling, especially if the cycles are deep, may degrade battery performance over time. The minimum time at charge state prevents the battery to change between charging and discharging within the number of minutes that you specify.

## Storage Dispatch Controller (Front of Meter)

The dispatch controller determines the timing of battery charges and discharges, and discharge limits. For front-of-meter systems (PPA, Merchant Plant financial models), you can either choose an automated dispatch model where SAM determines the timing automatically, input your own desired power signal for the battery, or define the timing manually using the monthly time-of-day matrices.

The manual dispatch controller allows you to maximize the value of storage by matching storage dispatch to the to the time-of-delivery (TOD) factors on the [Revenue](#) page for the Single Owner model, or the Time of Delivery factors page for the other PPA financial models.

## Dispatch Options

Choose the automated dispatch model that most closely represents how you would like the battery to be charged and discharged, or choose the manual dispatch option to specify the timings manually.

**Automated dispatch look ahead**

For each day, look ahead to the next day's available power from the system and time-of-delivery (TOD) multipliers, and operate system to maximize revenue.

**Automated dispatch one day look behind**

For each day, look behind to the previous day's available power from the system time-of-delivery (TOD) multipliers, and operate system to maximize revenue.

**Automated dispatch custom weather file**

Similar to the look ahead automated dispatch option, except, for the PV-battery configuration, use a different weather file for the solar resource forecast.

**Dispatch to custom time series**

Choose this option to charge and discharge the battery according to a time-series dispatch signal.

**Manual dispatch**

No automation. You specify the timing of battery charges and discharges using up to six dispatch periods and a set of weekday and weekend hourly profiles by month under **Manual Dispatch Model**.

The manual dispatch controller always assumes that PV meets the electric load before charging the battery. The PV system will charge the battery with any excess if that option has been selected for the current time.

## Charge Options

For non-manual dispatch options, choose the source of power for charging the battery.

### Battery can charge from grid

Allow the grid to charge the battery.

### Battery can charge from system

Allow the system to charge the battery.

### Battery can charge from clipped system power

Available for any of the three automated dispatch options for a PV system with DC-connected batteries only. This option will use any DC array power in excess of the inverter's nominal DC input power to charge the battery.

## Automated Dispatch Options

When you choose an automated dispatch option, provide additional information.

### Frequency to update dispatch

For any of the three automated dispatch options, determines how often a new dispatch decision is made.

### Look-ahead period

For the automated look ahead and automated custom weather file option, the number of hours ahead of the current time step to use for the dispatch decision in the current time step.

### Cycle degradation penalty option

For any of the automated dispatch options, choose a method for estimating the cost of cycling the battery: Choose **Calculate automatically** if you want SAM to calculate the cost, or choose **Enter penalty** to enter a cost per cycle-kWh value.

If you choose the "calculate automatically" option, SAM reports the calculated penalty as **Computed cycle degradation penalty** in the [battery time series results](#).

### Cycle degradation penalty

When you choose the "enter penalty" option for the cycle degradation penalty option, this is the penalty in \$/cycle-kWh of battery total capacity for cycling the battery. You can either enter a single value, or click the blue "val/sched" button to enter a different penalty for each year of the analysis period.

### Custom Weather File for Forecast

For the automated dispatch custom weather file option, click **Browse** to choose a weather file in the SAM CSV format to use for the solar resource forecast that is different from the file used for the simulation.

## Custom Time Series Dispatch

For the dispatch to custom time series option, provide a time series of battery power values. SAM will attempt to charge and discharge the battery to meet the battery power target values.

### Time series battery power targets

Click **Edit array** to enter time series battery power values. A negative power value for a time step indicates the battery controller should attempt to charge the battery at the given rate in that time step. A positive power value indicates the battery should discharge.

## Manual Dispatch Model

The manual dispatch option allows you to manually specify the timing of battery charges and discharges. Choose the **Manual dispatch** option under **Dispatch Options** to make the manual dispatch inputs active.

You can specify how you want to charge the battery (from grid or system), and whether to allow battery discharging for up to six periods. Use the weekday and weekend schedules to specify the hour of day and month of year that each period applies.

### Charge from system

For each period that you want to allow the battery to be charged by power from the system, check the box in the **Charge from system** column.

### Charge from grid

For each period that you want to allow the battery to be charged by power from the grid, check the box in the **Allow** column, and specify the percentage of the battery's state of charge that can be charged from the grid over the time step.

For example, for hourly simulations, a value of 25% would allow the grid to deliver 25% of the battery state of charge at the beginning of the hour over the hour. The purpose of the percentage is to prevent the battery from being charged too quickly. See the example below under **Discharge** for more details.

**Note.** For subhourly simulations, the charge and discharge percentages apply to the subhourly time step even though the periods are defined in hours.

For a behind-the-meter application, if **Charge from grid** and **Charge from system** are both checked for a given period, and if in a time step in that period the system power is greater than the [load](#), power from the grid will supplement the system power to meet the battery charge requirement.

If **Charge from grid** and **Allow discharging** are both checked for a given period, and if in a time step in that period the battery state of charge is above the minimum state of charge, the battery discharges until it reaches the minimum state of charge, at which point it starts charging from the grid, either until it reaches the maximum state of charge, or until the time period changes to one that does not allow charging from the grid.

### Discharge

For each period that you want to allow the battery to discharge, check the box in the **Allow** column, and specify the percentage of the battery's available charge that can be dispatched over the time step. The available charge is defined by the minimum and maximum state of charge values under **Charge Limits and Priority**.

For example, if Period 3 is the four consecutive hours between 3 pm and 6 pm, the discharge capacity is 25%, and the charge limits are 30% and 96%, for an hourly simulation, that would allow up to 25% of the charge the battery holds at the beginning of the 3 pm hour to be discharged over the hour. For the 4 pm hour, 25% of the charge at the end of the 3 pm hour would be available, and so on until the end of Period 3. The 25% value would discharge the battery over the full four-hour period. (A 20% value would have the same effect for a 5-hour period, i.e., if Period 3 were between 3 pm and 7 pm.)

For a one-minute simulation, a capacity to discharge of 25% would allow up to 25% of the available charge to be dispatched *every minute* over Period 3, so a smaller percentage would be required to allow the battery to discharge over the full four-hour period.

### Weekday and Weekend Schedules

To define the hour of day and month of year that each period applies, use your mouse to select a

rectangle in the schedule matrix, and use your keyboard to type the period number (1-6). The number you type should appear in the rectangle.

See [Weekday-weekend Schedules](#) for a step-by-step description of how to use the schedule matrices.

## 9.5 Results

You can find time series results for the battery storage models on the [Results](#) page after running a simulation. SAM displays time series data under Lifetime and Hourly (or n-minute) headings, depending on the simulation time step.

- The Lifetime results are outputs of the performance model simulation, which runs over the analysis period from the Financial Parameters page.
- The Hourly (or n-minute) Data results are for weather file records and other inputs that are for a single year. The Detailed Photovoltaic model uses the same weather data for each year of the lifetime simulation.

The time series results are available on the following tabs of the Results page:

- [Data tables](#)
- [Time series](#)
- [Profiles](#)
- [Statistics](#)
- [Heat map](#)
- [PDF/CDF](#)

SAM also reports monthly and annual totals of some of the time series values under the headings **Single Values**, **Monthly Data**, and **Annual Data**.

### Battery Storage Results

#### Lifetime Data

Name	Units	Description
Battery average cycle DOD		The average depth of discharge over the life of the battery, used for cycle degradation.
Battery capacity percent for temperature	%	The maximum capacity degradation or enhancement related to the battery temperature
Battery cell voltage	V	The voltage of each cell in the battery.

Battery computed cycle degradation	\$/cycle-kWh	The automatically computed cycle degradation penalty for automated dispatch, when the cycle degradation penalty option on the Battery Dispatch page is set to "calculate automatically."
Battery current	A	The current flow through the battery.
Battery cycle depth of discharge	%	The depth of discharge for the last elapsed cycle.
Battery max charge	Ah	The maximum charge capacity of the battery.
Battery maximum charge at temperature	Ah	The maximum charge capacity of the battery at the current time step due to temperature
Battery maximum charge with degradation	Ah	The maximum charge capacity of the battery at the current time step due to lifetime and cycling degradation
Battery number of cycles		A running count of how many charge/discharge cycles have elapsed.
Battery relative capacity to nameplate	%	The maximum battery capacity relative to the its original maximum capacity. This is the minimum value of cycling and lifetime degradation.
Battery relative capacity to nameplate (calendar)	%	The remaining capacity relative to the original capacity, where the degradation caused by the lifetime mechanisms.
Battery relative capacity to nameplate (cycling)	%	The remaining capacity relative to the original capacity, where the degradation caused by the cycling mechanisms.
Battery state of charge	%	The percentage of charge present in the battery relative to the maximum possible charge.
Battery temperature	°C	The bulk average temperature of the battery.
Battery total charge	Ah	The amount of charge currently present in the battery.
Battery voltage	V	The total voltage of all cells in the battery.

## 10 Wind

The Wind Power model is for projects involving one or more large or small turbines with any of the financial models for residential, commercial, or utility-scale PPA projects.

For a technical description of the wind power model, see Freeman, J.; Gilman, P.; Jorgenson, J.; Ferguson, T. (2014). "Reference Manual for the System Advisor Model's Wind Performance Model." National Renewable Energy Laboratory, NREL/TP-6A20-60570. ([PDF 738 KB](#))

**Note.** If you are new to SAM, you can use the Wind Wizard to create a wind case. The Wizard steps you through the inputs you need to create a basic case. To run the Wind Wizard, either start SAM and click **Quick start for new users** at the bottom left corner of the Welcome page, and then click **Wind Wizard**. If SAM is running, on the File menu, click **Close** to return to the Welcome page.

### Wind Power Model Algorithm

SAM's wind power model uses wind resource data that you specify on the [Wind Resource](#) page to calculate the electricity delivered to the grid by a wind farm that consists of one or more wind turbines.

SAM can either read wind resource data from a time series data file in the [SRW](#) format, or make calculations based on an estimate of the wind resource specified using a Weibull distribution.

SAM calculates the wind farm's output over a single year in hourly time steps. It uses the following algorithm to calculate the wind farm output for each time step of the simulation:

1. Determine the wind data height, and adjusts the wind resource data to account for differences between the turbine hub height and the wind resource data height. See [Hub Height and Wind Shear](#) below for details.
2. Calculate output of a single turbine, accounting for the turbine's height above the ground.  
On the [Turbine](#) page, you choose to represent the turbine's performance characteristics either as a turbine power curve from the turbine library, or by specifying values for a set of turbine design parameters. For both options, you also specify a turbine hub height and shear coefficient.
3. Calculate output of wind farm, accounting for wake effects.  
On the [Wind Farm](#) page, you specify the number of turbines and wind farm layout geometry for a simple representation of a wind farm on a flat surface, and a value for the ambient turbulence intensity. See [Wake Effect Model](#) below for details.
4. Adjust wind farm output.  
You can account for additional losses by specifying a value for a wind farm loss factor on the [Wind Farm](#) page.
5. Calculate electricity delivered to the grid.  
SAM adjusts the wind farm's output using the losses you specify for system availability or other operating losses.

### Hub Height and Wind Shear

SAM makes wind shear adjustments to account for variation in wind speed with height above the ground.



When you choose the **Wind Resource by Location** option (time series data from a wind data file) on the [Wind Resource](#) page, SAM ignores the value of the **Shear Coefficient** on the [Turbine](#) page when the data file contains wind speed data columns for more than one height and the turbine hub height is between the minimum and maximum wind data heights in the file. SAM looks for the data column with the measurement height closest to the hub height. If it finds an exact match, it uses that data column. If it does not find an exact match, SAM finds the two measured heights on either side of the hub height and uses linear interpolation to estimate the wind speed at the hub height.

For wind direction data, SAM interpolates to estimate wind direction at different hub heights when the wind direction for two neighboring measurement heights differ by less than 90 degrees. Otherwise it uses the direction measured closest to the hub height.

**Note:** SAM stops the simulation and reports a simulation error if either of the following is true:

The hub height is more than 35 meters above the highest measurement height or more than 35 meters below the lowest measurement height.

The measurement height used for the wind speed is more than 10 meters from the measurement height used for direction.

## Wind Power Law

SAM uses the value of the **Shear Coefficient** on the [Turbine](#) page to estimate the wind speed at the hub height instead of the method described above under the following conditions:

- The wind speed data in the wind data file is measured at more than one height, and the turbine hub height is above the maximum height or below the minimum height in the file.
- The wind data file with contains wind speed data measured at a single height.
- You choose the **Wind Resource Characteristics** option on the [Wind Resource](#) page to specify a Weibull distribution instead of a wind data file.

The wind power law equation to estimate the wind speed at the turbine height  $v_{hub}$ , using the wind speed  $v_{data}$  and wind measurement height  $h_{data}$  from the data file, and the turbine hub height  $h_{hub}$  and shear coefficient is:

$$v_{hub} = v_{data} \times \left( \frac{h_{hub}}{h_{data}} \right)^\alpha$$

For data from a wind file with more than one column of wind speed data,  $h_{data}$  is either the lowest or highest wind speed data height, whichever is closest to the hub height. For a wind data file with wind speed data measured at one height,  $h_{data}$  is the that height. For wind resource that you specify using a Weibull distribution,  $h_{data} = 50$  meters.

## Elevation above Sea Level

SAM assumes that the wind turbine power curve on the [Turbine](#) page represents the turbine's performance at sea level. How SAM adjusts the turbine power curve to represent its performance at the project elevation above sea level depends on the options you choose to model the wind resource and turbine.

When you choose the **Wind Resource by Location** option (time series data from a wind data file) on the [Wind Resource](#) page, SAM does not use the elevation above sea level value. Instead, it uses the ideal gas

law with values from the wind resource file to calculate the air density  $\rho$ , in each hour, and adjusts the hourly turbine output by the ratio of air density to the air density at sea level:  $\rho / 1.225 \text{ kg/m}^3$ . The air density is a function of the air temperature  $T$  (converted to Kelvin) and atmospheric pressure  $P$  from the wind resource file, and the gas constant  $R_{\text{specific}} = 287.058 \text{ J/kg}\cdot\text{K}$ :

$$\rho = \frac{P}{R_{\text{specific}} \cdot T}$$

When you choose the **Wind Resource Characteristics** option (Weibull distribution) with:

- The **Select a turbine from the list** option on the [Turbine](#) page, SAM does not adjust the power curve, effectively modeling the turbine as if it were installed at sea level.
- The **Define the turbine characteristics below** option, SAM uses the **Wind farm elevation** value that you provide to calculate the air density for the turbine power output calculations.

## Wake Effect Model

As wind passes through a wind turbine rotor, its speed and turbulence characteristics change. For wind farms with more than one turbine, the spacing of turbines affects the wind farm output because upwind turbines can reduce the energy in the wind available for downwind turbines.

SAM allows you to choose from three different wake effect models to estimate the effect of upwind turbines on downwind turbine performance:

- **Simple Wake Model** is described below, and in more detail in Chapter 3 of Quinlan P (M.S., 1996), *Time Series Modeling of Hybrid Wind Photovoltaic Diesel Power Systems*, University of Wisconsin-Madison. ([ZIP 2.1 MB](#)).
- **Park (WAsP)** is described in [Open Wind Theoretical Basis and Validation](#) (Version 1.3, April 2010), 2.1 Park Model, p. 6.
- **Eddy-Viscosity** is described in [Open Wind Theoretical Basis and Validation](#) (Version 1.3, April 2010), 2.3 Eddy-Viscosity Wake Model, p. 7.

## Simple Wake Model

The model makes the following simplifying assumptions:

- All turbines in the wind farm have the same hub height and height above sea level.
- The wind farm terrain is uniform with a single ambient turbulence coefficient

The wake model uses wind direction data from the wind data and information about the relative position of turbines from the inputs you specify on the [Wind Farm](#) page to calculate the distance between neighboring downwind turbines and neighboring crosswind turbines. It then calculates a set of coefficients representing the effects of the turbine on the wind speed:

- Power coefficient,  $C_p$
- Thrust coefficient,  $C_t$
- Turbulence coefficient,

The power and thrust coefficients are related by the axial induction factor,  $a$ :

$$C_p = 4 \cdot a \cdot (1 - a)^2$$

$$C_t = 4 \cdot a \cdot (1 - a)$$

The resulting relationship between  $C_p$  and  $C_t$  for  $0 < C_p < 0.6$  is:

$$C_t = -A + B \cdot C_p + C \cdot C_p^2 + D \cdot C_p^3$$

Where  $A = -0.01453989$ ,  $B = 1.473506$ ,  $C = -2.330823$ , and  $D = 3.885123$ .

The power coefficient is a function of the turbine power  $P_{turbine}$  that SAM calculates from the power curve and the theoretical power in the wind  $P_{wind}$ :

$$C_p = \frac{P_{turbine}}{P_{wind}}$$

The theoretical power in the wind  $P_{wind}$  depends on the air density  $\rho_{air}$ , wind speed  $v_{wind}$ , and rotor radius,  $r_{rotor}$ :

$$P_{wind} = 0.5 \cdot \rho_{air} \cdot v_{wind}^3 \cdot \pi \cdot r_{rotor}^2$$

The difference in wind speed  $\Delta U$  between an upwind and downwind turbine is then:

$$\Delta U = \frac{C_t}{4 \cdot \sigma^2 \cdot x^2} \cdot e^{\left(\frac{-r^2}{2 \cdot \sigma^2 \cdot x^2}\right)}$$

Where  $\sigma$  is the local turbulence coefficient at the turbine, and  $x$  and  $r$  are, respectively, the downwind and crosswind distance between turbines expressed as a number of rotor radii.

The local turbulence coefficient calculation is beyond the scope of this description. For the first turbine, the value is equal to the turbulence coefficient on the Wind Farm page. For downwind turbines, see Quinlan (1996) p 55-57.

## 10.1 Wind Resource

Use the Wind Resource page to define the wind resource at the project site. You can either use a [properly formatted wind resource file](#), or define the parameters of a wind speed Weibull distribution.

For a technical description of wind resource options, see Chapter 4 of Freeman, J.; Gilman, P.; Jorgenson, J.; Ferguson, T. (2014). "Reference Manual for the System Advisor Model's Wind Performance Model." National Renewable Energy Laboratory, NREL/TP-6A20-60570. ([PDF 738 KB](#))

**Note.** If you are new to SAM, you can use the Wind Wizard to create a wind case. The Wizard steps you through the inputs you need to create a basic case. To run the Wind Wizard, either start SAM and click **Quick start for new users** at the bottom left corner of the Welcome page, and then click **Wind Wizard**. If SAM is running, on the File menu, click **Close** to return to the Welcome page.

After running a simulation, SAM reports the hourly or subhourly wind speed and wind direction on the Results page [tables](#) and [time series graphs](#) so you can see what values it used in the simulation. For a general description of how the wind power model uses the data in the file, see [Wind](#):

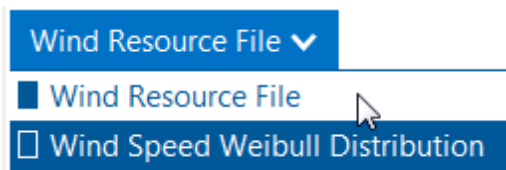
- For a description of how SAM determines wind speed at hub height, see [Hub Height and Wind Shear](#).
- For a description of how SAM uses temperature and pressure data from the weather file, see [Elevation above Sea Level](#).

**To choose how to define the wind resource:**

1. Choose **Wind Resource File** to use time series data in a weather file. There are three options for using wind resource data in a weather file: There are three options for choosing a wind resource file:
  - [Choose a representative wind resource](#) file to use a file in SAM's wind resource library.
  - [Download a wind resource file](#) from the NREL WIND Toolkit.
  - [Use a wind resource file stored on your computer.](#)

To view the data in a wind resource file, either open it in a text editor or spreadsheet program, or if you use the file for a simulation, you can see the data on the Results page, either in the [data](#) table under Hourly, or in the [time series](#) graphs.

2. Choose **Wind Speed Weibull Distribution** to use parameters for a Weibull distribution.

**Wind Resource File: Choose a representative typical wind resource file**

SAM comes with a set of representative typical wind resource files that are appropriate for very preliminary studies to explore the feasibility of potential projects, or for policy studies. The files were developed for NREL by [AWS Truepower](#). Each file contains simulated hourly resource data and includes wind speed, wind direction, ambient temperature, and atmospheric pressure data at 50, 80, and 110 meters above the ground.

**Choose a representative typical wind resource file:**

1. In the list of files, choose the name of the file. You can type a few letters of a location name to filter the list.

The file may be one of the typical wind data files included with SAM, a wind data file you downloaded, or a file that you created with your own data.

**Note.** To view the wind resource data in SAM's time series data viewer, run a simulation, and click the **Time Series** tab on Results page.

SAM displays information that describes the location represented by the data from the file for your information. This information is stored in the file header. SAM does not use any of this information or data in the simulation.

**Description**

A text description of where the data in the file came from.

**Latitude / Longitude**

If you use the Download Weather File feature to download a file, this is the latitude and longitude in decimal degrees of the location represented by the data. (It may differ from the latitude of the location you requested.)

If the wind data file does not have a value for the latitude and longitude, SAM displays "N/A."

**Elevation above sea level**

The location's height above sea level.

SAM does not use this value in calculations. It uses the temperature and atmospheric pressure data from the file to calculate the air density.

### City / State / Country

The city, state, and country names stored in the file.

### Refresh Library

Refreshes the list of files in the location list. SAM automatically refreshes the list each time you visit the Wind Resource page. If you add a file to one of the folders in the search list, you may need to refresh the list for the file to be visible in the location list.

The files are for 39 representative locations, and use the following naming convention: *[State] [Region]-[Terrain Description].srw* to help you choose an appropriate file. For example, the file *AZ Eastern-Rolling Hills.srw* contains data appropriate for a location in eastern Arizona with rolling hills.

- *State* indicates where the data in the file was measured.
- *Region* is the part of the state where the data was measured.
- *Terrain Description* describes the type of terrain at the measurement site. See the table below for Google Earth images of the different terrain types.

Each file contains typical month data for a single year selected from the 14 years between 1997 and 2010. See [Typical Year and Single Year Weather Data](#) for a brief description of typical year data.

When you use one of these files, you should examine the data with SAM's [Weather Data Viewer](#) to make sure it is appropriate for your analysis. You may want to compare the data in the file to data from nearby meteorological stations or other data. Some things to look for are:

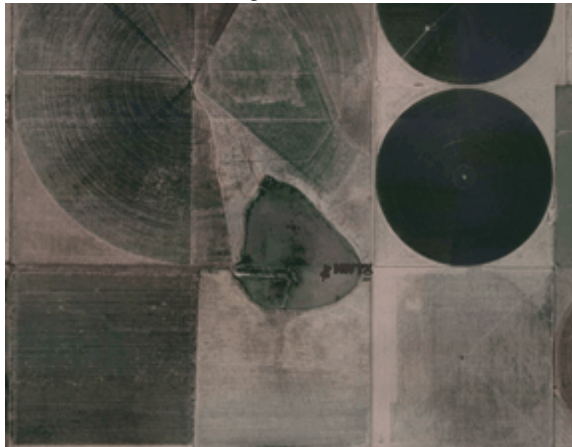
- The annual average wind speed is close to what you expect.
- The prevailing wind direction is similar to what you would expect at the site you are investigating. (This only matters if you are modeling a wind farm with more than one turbine.)
- The annual diurnal wind speed pattern is similar to what you would expect at the site.

Using data with similar terrain type as the site under investigation may help ensure that the wind shear profile (variation of the wind with height above the ground) of the data is reasonable for the site.

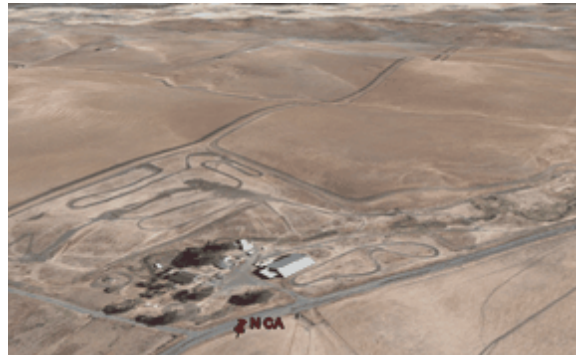
If you want to use one of the representative typical wind data files for a location that is not among the 39 representative locations, you can try to find a file with characteristics similar to those of your site.

You can use the images below to help choose a typical file with terrain characteristics similar to your site.

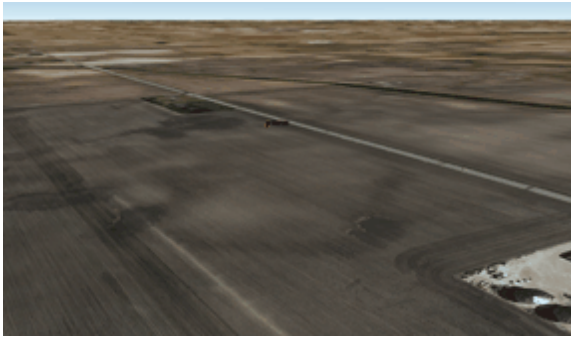
Agriculture



Barren/Prairie



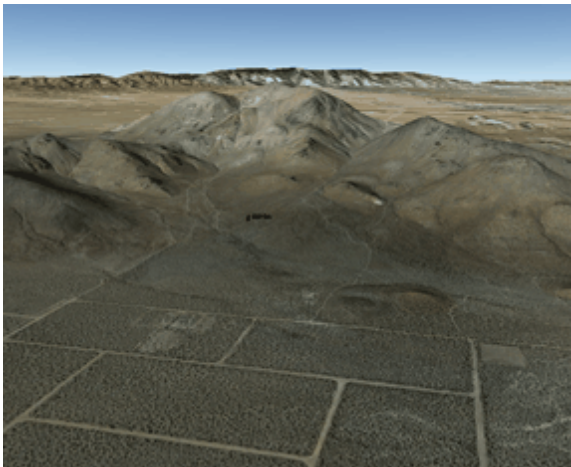
Flat Lands



Forest



Mountainous



Offshore



Rolling Hills



▼ Option 2: Download a wind resource file from the online NREL WIND Toolkit



NREL's Wind Integration National Dataset (WIND) Toolkit provides wind speed and direction, ambient temperature, and atmospheric pressure at 100 m above the ground data for 126,692 sites in the continental United States and parts of Central America and the Caribbean. Of those sites, 112,471 are on land, and 14,221 are offshore in coastal areas. The WIND Toolkit provides historical [single-year](#) data for the time period between 2007 and 2013 for measurement heights between 10 and 200 meters above the ground.

For a description of the WIND Toolkit:

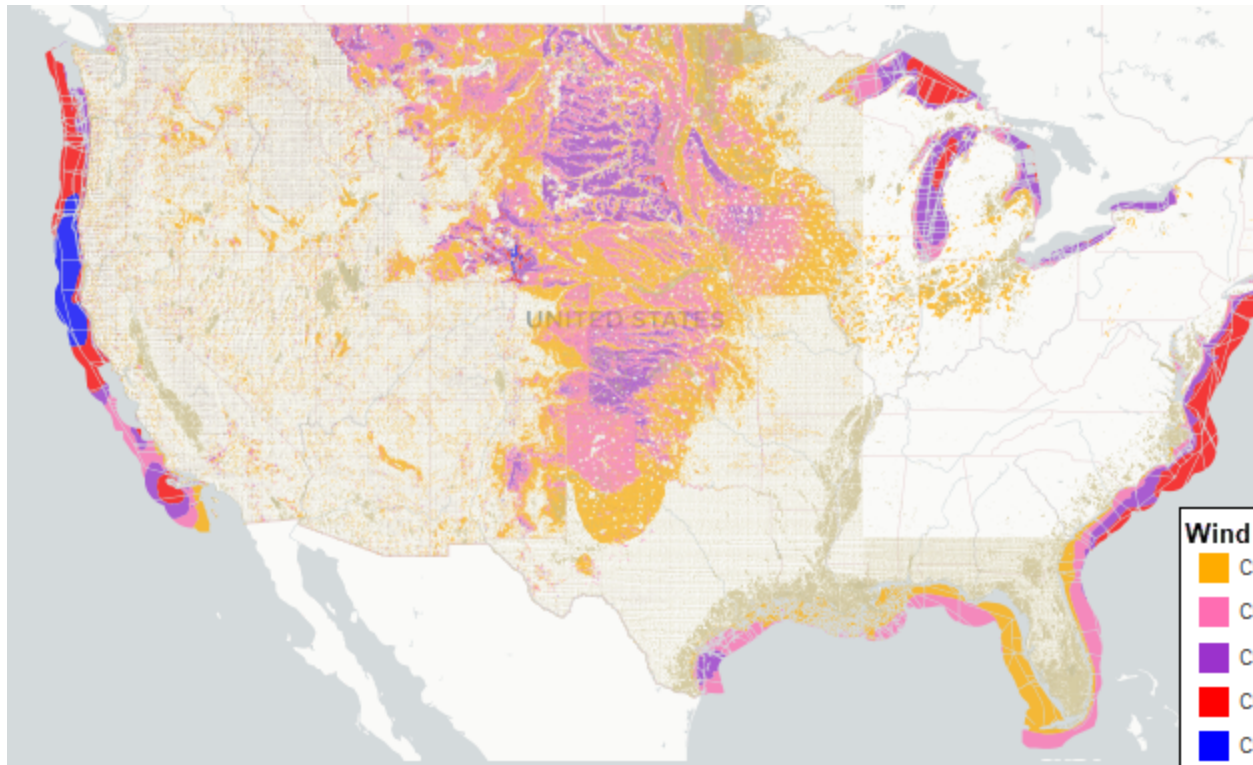
- [Wind Integration National Dataset Toolkit website](#)
- Draxl, C et. al. Advancements in Wind Integration Study Data Modeling: The Wind Integration National Dataset (WIND) Toolkit. Preprint. 2013. NREL Conference Paper. NREL/CP-5D00-60269. ([PDF 142 KB](#))

For an interactive map showing the site locations:

- [Wind Prospector website](#)

The WIND Toolkit API on the NREL Developer Network:

- [WIND Toolkit API](#)



**Map from Wind Prospector website showing locations of WIND Toolkit data sites. Colors indicate the capacity factor for each site as estimated by the toolkit.**

Each wind data site is represented in the WIND Toolkit as a 2 km by 2 km grid cell. When you use SAM to request wind data for a project location, SAM sends the location's latitude and longitude to the toolkit. The toolkit finds the wind data grid cell nearest the project location and returns a weather file that SAM stores on your computer. SAM names the file using the latitude and longitude of the project location you provided. You can find the latitude and longitude of the wind data grid cell in the header of the weather file. When you use

a street address in SAM to describe the project location, SAM translates the street address to a latitude and longitude using the Google Maps Geolocation API.

### **To download a weather file from the NREL WIND Toolkit:**

1. Click **Download**.
2. Type a latitude and longitude, street address, or zip code for the wind turbine or farm location.
3. Choose a year.
4. Choose one or more hub heights. Use ctrl-click to select more than one hub height.

**Note.** Downloads with multiple hub heights may take a long time to download. To minimize download times, choose measurement heights near the turbine hub height you plan to model.

5. Click **OK**.

SAM displays a message when the download is complete, and checks the box under **Use a wind resource file stored on your computer** and shows the path of the downloaded file.

SAM downloads a file from the WIND Toolkit for the site nearest the location you request, and stores in the folder indicated on the Wind Resource page under **Use a wind resource file stored on your computer**.

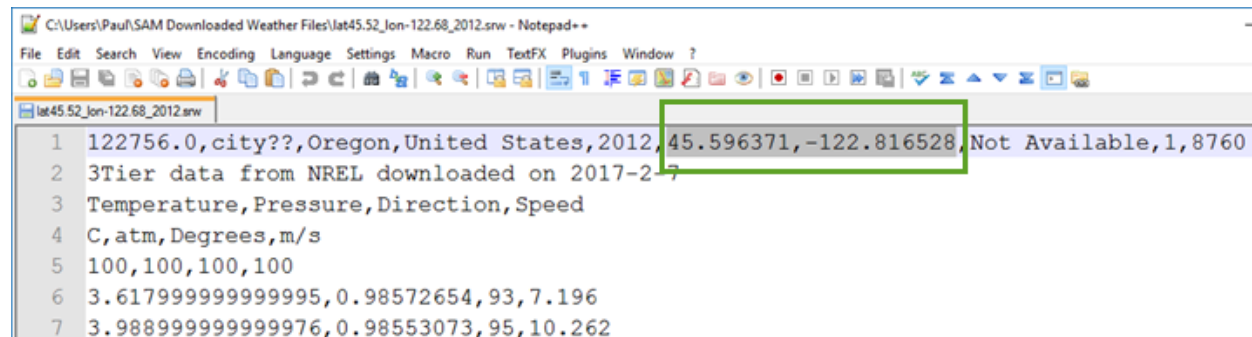
The latitude and longitude in the file name was translated from the street address above using the Google Maps Geolocation API. SAM includes the coordinates for the location you requested in the .srw file name:

**Use a wind resource file stored on your computer**

C:\Users\Paul\SAM Downloaded Weather Files\lat45.52\_lon-122.68\_2012.srw

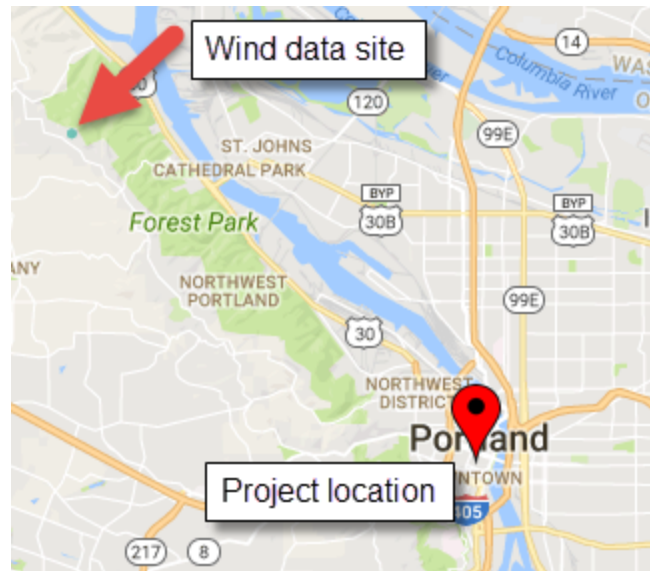
Check the box and click Browse to choose a an .srw file stored on your computer without adding it to the wind resource library.

You can see the latitude and longitude of the WIND Toolkit data site by opening the weather file in a text editor or spreadsheet program:



```
C:\Users\Paul\SAM Downloaded Weather Files\lat45.52_lon-122.68_2012.srw - Notepad++
File Edit Search View Encoding Language Settings Macro Run TextFX Plugins Window ?
lat45.52_lon-122.68_2012.srw
1 122756.0,city??,Oregon,United States,2012,45.596371,-122.816528,Not Available,1,8760
2 3Tier data from NREL downloaded on 2017-2-7
3 Temperature, Pressure, Direction, Speed
4 C, atm, Degrees, m/s
5 100,100,100,100
6 3.6179999999999995,0.98572654,93,7.196
7 3.98899999999999976,0.98553073,95,10.262
```





### Option 3: Use a wind resource file stored on your computer

You can use a [properly formatted weather file](#) stored on your computer without adding it to the library.

#### **To use a weather file on disk:**

1. Check the box under **Use a specific weather file on disk.**
2. Click **Browse** to navigate to the file

**Use a wind resource file stored on your computer**

Check the box and click Browse to choose a an .srw file stored on your computer without adding it to the wind resource library.

### Wind Speed Weibull Distribution

Define the wind resource using an annual wind speed and Weibull K factor. Use this option for wind turbine design studies when you want to examine the performance of a wind turbine under different wind resource regimes.

**Note.** When you choose the **Wind Resource Characteristics** option, you can only model a project with a single wind turbine. SAM disables the inputs on the [Wind Farm](#) page because there is no data describing wind direction that SAM requires to model systems with more than one turbine.

#### **Average Annual Wind Speed (@ 50 meters)**

The average annual wind speed at the turbine location at 50 meters above the ground.

#### **Weibull K Factor**

The wind resource's Weibull K factor, describing the annual distribution of wind speeds at the turbine site.

### Elevation Above Mean Sea Level

The height of the ground at the turbine site above mean sea level. This variable is active only when you choose the **Define turbine characteristics below** option on the [Turbine](#) page.

SAM displays a graph of probability distribution functions for of the wind resource that you specify. The graph shows the Weibull and Rayleigh probability distribution of the wind speed data, and the Weibull Betz probability distribution of energy over a range of wind speeds.

After running a simulation, you can display [tables](#) of the 160 data bins on the Results page for the annual energy, hub efficiency, and turbine power curve values.

## 10.2 Wind Turbine

The wind turbine parameters specify the turbine power curve and hub height of a single turbine.

For a project with multiple turbines, SAM assumes that the [wind farm](#) consists of identical turbines.

For a technical description of the wind turbine models, see Chapters 5-7 of Freeman, J.; Gilman, P.; Jorgenson, J.; Ferguson, T. (2014). "Reference Manual for the System Advisor Model's Wind Performance Model." National Renewable Energy Laboratory, NREL/TP-6A20-60570. ([PDF 738 KB](#))

For information about small wind certification, see:

- [Small Wind Certification Council](#)
- [IREC Certified Wind Turbines](#)

SAM offers two options to specify the turbine parameters:

### Select a Turbine from the library

Choose a turbine from SAM's wind turbine library. SAM automatically populates the power curve, **Rated Output** and **Rotor Diameter** values from the library. You cannot change these values.

Use this option when you want to model a project that uses commercially available wind turbines.

**Note.** If you have power curve data for a turbine that is not in the library, you can use a text editor or spreadsheet program to add it to the library. The library file is *Wind Turbines.csv* in the *libraries* folder of your [SAM installation folder](#).

### Define the turbine characteristics

Use this option when you are investigating different turbine design parameters.

For either option, you specify the turbine hub height and shear coefficient:

#### Hub Height

The height of the center of the rotor above the ground.

**Note.** If you specify a wind resource file on the [Wind Resource](#) page, and the difference between the hub height and the nearest wind speed data height in the file is greater than 35 meters, SAM stops the simulation and generates an error message.

### Shear Coefficient

The shear coefficient is a measure of the variation in wind speed with height above the ground at the turbine installation site. The default value of 0.14 (1/7) is a common assumption for the value in wind resource studies on land, and 0.11 may be appropriate over water for offshore wind farms.

How and whether SAM uses the shear coefficient to estimate the wind speed at the turbine's hub height depends on the option you choose on the [Wind Resource](#) page:

- For the **Wind Resource by Location** option (wind data file with time series data), SAM ignores the shear coefficient unless the file contains wind speed data at only a single height, or when the turbine hub height is either below the lowest height or above the highest height in the file.
- For the **Wind Resource Characteristics** option (specify a Weibull distribution), SAM uses the shear coefficient with the power law, assuming that the measured wind speed height is 50 meters above the ground.

See [Wind Shear and Power Curve Adjustments](#) for an explanation of how SAM uses this value.

### Wind Turbine Design Characteristics

The wind turbine design parameters are the input variables that are active when you choose the **Define the turbine design characteristics** option.

For a description of how SAM uses these inputs to calculate the turbine's power curve, see Section 5.2 of Freeman, J.; Gilman, P.; Jorgenson, J.; Ferguson, T. (2014). "Reference Manual for the System Advisor Model's Wind Performance Model." National Renewable Energy Laboratory, NREL/TP-6A20-60570. ([PDF 738 KB](#))

#### User-defined Rated Output

The turbine's nameplate capacity in kW.

#### User-defined Rotor Diameter

The turbine's rotor diameter in meters.

#### Maximum Cp

The rotor's power efficiency.

The fraction of the rotor's total available power that the blades can convert to mechanical power. The theoretical maximum is the Betz limit of 0.59.

#### Maximum tip speed

The maximum velocity of the blade tip.

#### Maximum tip-speed Ratio

The maximum ratio of the blade tip speed to wind speed.

#### Cut-in wind speed

The minimum wind speed at which the turbine generates electricity.

#### Cut-out wind speed

The maximum wind speed at which the turbine generates electricity.

#### Turbine elevation (above sea level)

The elevation of the ground at the base of the turbine's tower.

**Drive Train Design**

Choose an option from the four available designs.

**Blade Design**

Choose an option from the two available designs.

**Tower Design**

Choose an option from the two available designs.

## 10.3 Wind Farm

The Wind Farm page allows you to specify the number of turbines in the project and includes a simple representation of the wind farm layout to estimate wake effect losses that result when upwind turbines interfere with wind flow to downwind turbines.

For a technical description of the wind farm model, see Chapter 8 of Freeman, J.; Gilman, P.; Jorgenson, J.; Ferguson, T. (2014). "Reference Manual for the System Advisor Model's Wind Performance Model." National Renewable Energy Laboratory, NREL/TP-6A20-60570. ([PDF 738 KB](#))

### System Sizing

The system sizing options are only available with the **Wind Resource File** option on the [Wind Resource](#) page. The options are disabled when you run the model with a Weibull distribution for the wind resource.

**Use a single turbine**

Choose this option to model a project with one wind turbine. For this option, the Turbine Layout options are disabled.

**Specify desired farm size**

SAM calculates the number of turbines for a given wind farm capacity. For this option, SAM automatically defines a basic turbine layout for the wind farm that you cannot modify.

**Specify number of turbines and farm layout**

You specify the number of turbines in the project and how they are laid out. SAM assumes that all of the turbines in the wind farm are of the same type and at the same elevation above sea level.

**Desired farm size**

The desired nameplate capacity of the wind farm when you choose the Specify desired farm size option.

SAM displays a message when the capacity you specify is not an even multiple of the nameplate capacity of a single turbine. For example, if the capacity of a single turbine is 1,500 kW and you specify a farm capacity of 5,000 kW, SAM uses three turbines for a farm capacity of 4,500 kW and displays a message telling you that it cannot meet the desired capacity exactly.

**Number of Turbines**

The calculated number of turbines in the project. The value is either the number you specify under **Turbine Layout** or based on the desired farm capacity you specify.

When you use the turbine layout generator, for a square, rectangle, or parallelogram shape:

$$\text{Turbines in Layout} = \text{Turbines per Row} \times \text{Number of Rows}$$

For a triangle or trapezoid shape, SAM assumes that each row has one less turbine than the previous row:

$$\begin{aligned} \text{Turbines in Layout} = & \text{Turbines in First Row} + \text{Turbines in Second Row} + \text{Turbines in Third Row} \\ & + \dots + \text{Turbines in Last Row} \end{aligned}$$

### System Nameplate Capacity

Total capacity of the project in kilowatts, equal to the product of the number of turbines in the wind farm and the nameplate capacity of a single turbine (**Rated Output** from the [Turbine](#) page).

## Wake Effects

The wake effects losses account for the reduction in output of turbines positioned in the wake of other turbines in the wind farm.

**Note.** The wake effect model calculates internal wake losses. You can specify additional wake effects losses on the [Losses](#) page.

### Turbulence Coefficient

The ambient turbulence intensity representing variation in wind speed caused by terrain or local thermal effects as air moves across the wind farm. SAM uses this value in the [wake effect model](#). Wake effects are more significant for a wind farm with a lower turbulence coefficient than for one with a higher coefficient.

The turbulence intensity is the standard deviation of the wind speed at a short time step divided by the mean wind speed. For smooth terrain such as a flat plain with little vegetation and a low turbulence coefficient, a typical value might be 0.1 (or less over water for offshore wind farms). For a forest or area with air mixing caused by thermal effects with a high turbulence coefficient, a typical value might be 0.5.

### Wake Model

SAM allows you to choose from three different wake effect models to estimate the effect of upwind turbines on downwind turbine performance. For details see [wake effect model](#).

**Note.** If you want to include internal wake losses in an uncertainty analysis, choose the **Constant loss** option.

- **Simple Wake Model** uses a thrust coefficient to calculate the wind speed deficit at each turbine due to wake effects of the upwind turbines. This is the original wake effect model used in SAM versions 2013.1.15 and earlier.
- **Park (WAsP)** calculates the wind speed deficit behind each turbine using a decay constant, and calculates the overlap of that wake profile with the downwind turbine to calculate the wind speed at the downwind turbine. This model was originally developed for the [Risø DTU WAsP](#) wind farm model.
- **Eddy-Viscosity** is similar to the Park model, except that the wind speed deficit behind each turbine is assumed to have a Gaussian shape (there is no decay constant).
- **Constant Loss** models wake loss as a constant percentage reduction in the wind farm output.

## Turbine Layout

The Turbine Layout options allow you to specify the parameters of a project with two or more turbines. You must check **Specify number of turbines and farm layout** to make the parameters active.

You can either specify the turbine layout using the turbine and row spacing inputs, or by importing a text file of turbine locations.

### Import wind turbine location data file

Use this option to import a text file of turbine locations. When you import the file, SAM displays the turbine locations in the turbine layout map.

Click **Import turbine layout file** to open the file. SAM looks for a file with the .csv extension with the following format:

- A text file.
- The first row is a header that SAM ignores.
- Rows 2 to up to 502 each contain comma-separated values of x,y coordinates in meters indicating a single turbine's position as it would appear on the turbine layout map.

### Define wind farm using layout generator (below)

Use this option to specify the turbine locations using turbine and row spacing inputs.

### Turbine Layout Map

A diagram showing the locations of turbines in the field. Each blue dot in the map represents a turbine.

### Turbines per row

For the **Square / Rectangle / Parallelogram** shape, **Turbines per row** is the number of turbines in each row.

For the **Triangle / Trapezoid** shape, **Turbines per row** determines the number of turbines at the base of a triangle or trapezoid. SAM assumes that the number of turbines in each successive row is one less than in the previous row.

### Number of rows

Number of rows of turbines in the wind farm.

### Shape

Choose the shape defined by lines connecting outermost turbines in the project.

### Notes.

To specify a triangle shape, **Number of Rows** should be equal to **Turbines in First Row**. For a trapezoid, Number of Rows should be less than **Turbines in First Row**.

If you specify more rows than there are turbines in the first row, SAM assumes a triangle shape, and sets the number of rows equal to the number of turbines in the first row.

### Turbine Spacing

Distance in meters between turbines in each row.

### Row Spacing

Distance in meters between rows.

### Offset for Rows

The distance in meters between a line drawn through a turbine perpendicular to its row, and a similar line drawn through a turbine in the nearest neighboring row.

### Offset Type

**Every Other Row** applies the offset distance to alternating rows.

**Each Row** applies the distance to every row.

### Row Orientation

The angle west of north of a line perpendicular to the rows of turbines. A value of either zero or 180 degrees means the rows are parallel to the equator.

You can set the value by either typing a number or dragging the slider with your mouse.

The compass rose indicates the cardinal directions.

## 10.4 Losses

The Losses page allows you to account for system performance losses that are not included in the wind turbine power curve from the [Wind Turbine](#) page and other assumptions. Each loss is expressed as a percentage of the total annual system output before losses.

The losses inputs are designed to work with the inputs on the [Uncertainties](#) page if you

### Notes.

The losses you specify on the Losses page apply in addition to any losses you specify on the [Wind Farm](#) and [Grid Limits](#) pages.

You can use the Losses inputs in conjunction with the inputs on the [Uncertainties](#) page to include losses in your uncertainty analysis.

The following notes supplement the descriptions on the Losses input page:

### Wake Losses

The internal wake value comes from the [Wind Farm](#) page when you choose the **Constant Loss** option for the wake model. If you choose one of the other wake model options, SAM sets the internal wake value to zero.

### Availability Losses

Previous versions of SAM uses an "availability and curtailment" matrix to model the effect of both system availability losses due to maintenance downtime and other operational considerations and energy curtailment due to power output limits imposed by the electricity off-taker or grid operator. In the current version of SAM, use the availability losses to account for operational availability and use the inputs on the [Grid Limits](#) page to account for curtailment.

### Electrical Losses

No additional notes.

## Turbine Performance Losses

No additional notes.

## Environmental Losses

No additional notes.

## Curtailement / Operational Strategies Losses

These losses apply in addition to the curtailment losses from the [Grid Limits](#) page. If your project earns [revenue](#) for curtailment payments, SAM calculates that revenue from the grid limits curtailment rather than from the curtailment losses defined on the Losses page.

## 10.5 Uncertainties

The Uncertainties inputs allow you to specify uncertainties for different input parameters to calculate the probability distributions displayed on the [Uncertainties](#) tab of the [Results](#) page.

The uncertainty model is drawn from the [IEC 61400-15](#) uncertainty framework as described in Damiani, R. (2018). Uncertainty and Risk Assessment in the Design Process for Wind. National Renewable Energy Laboratory, NREL/TP-5000-67499 ([PDF 8.9 MB](#)).

## 10.6 System Costs

The Wind System Costs page allows you to specify the costs of a wind power project. For information about sources of wind cost data, see <https://sam.nrel.gov/wind.html>.

### Notes.

The default cost values that appear when you create a file or case are intended to illustrate SAM's use. The cost data are meant to be realistic, but not to represent actual costs for a specific project. For more information and a list of online resources for cost data, see the technology pages on the [SAM website](#).

The System Costs page is only available for cases with a cash-flow-based financial model. It is not available with the No Financial Model option or the LCOE Calculator financial model.

## Capital Cost Models

The capital cost models are implementations of NREL cost models that you can use to estimate turbine and balance-of-system (BOS) costs.

### Land-based installation

Choose this option to apply capital costs from NREL cost models for land-based wind farms.



### Offshore installation

Choose this option to use default values for offshore wind farms.

### Estimate turbine costs now

Replace the **Turbine cost** "cost per kW" value with a value from the NREL cost models, and set the "cost per turbine" and "fixed cost" values to zero. The cost estimates include sales tax, so this also sets the sales tax basis to zero.

### Go to balance-of-system (BOS) cost model inputs

Click this button to show the inputs for either the land-based or offshore BOS cost models. To apply a BOS cost from one of the BOS, first populate the inputs for either the land-based or offshore BOS model, and then click **Apply BOS Estimate** to apply the value.

- [Land Based Balance of System Cost model](#)
- [Offshore Balance of System Cost model](#)

## Capital Costs

A capital cost represents an expense for a specific piece of equipment or installation service that applies in year zero of the cash flow.

**Note:** Because SAM uses only the total installed cost value in cash flow calculations, how you distribute costs among the different direct capital cost categories does not affect the final results.

For each direct cost category, you can specify the cost in \$/kW of wind farm capacity, a fixed cost in \$, or a cost per turbine in \$/turbine. If you specify more than one cost, for example a foundation cost in both \$/kW and \$/turbine, SAM adds the values together to calculate the total category cost.

### Turbine Cost

The cost of a single turbine. You can type values in \$/kW, \$/turbine, fixed amount, or a combination of the three. The total turbine cost is the sum of three values.

### Balance of System cost

Material, labor, and other costs associated with building turbine foundations for the entire wind farm. You can type values in \$/kW, \$/turbine, fixed amount, or a combination of the three. The total turbine cost is the sum of three values.

### Wind farm capacity

The wind farm's nameplate capacity from the [Wind Farm](#) page.

### Number of turbines

The number of turbines in the project from the [Wind Farm](#) page.

### Total installed cost

The sum of the total turbine cost and total balance of system cost.

### Total installed cost per kW

The total installed cost divided by the wind farm nameplate capacity.

## Operation and Maintenance Costs

Operation and Maintenance (O&M) costs represent annual expenditures on equipment and services that

occur after the system is installed. SAM allows you to enter O&M costs in three ways: Fixed annual, fixed by capacity, and variable by generation. O&M costs are reported on the project [cash flow](#) in Years 1 and later..

For each O&M cost category, you can specify an optional annual **Escalation Rate** to represent an expected annual increase in O&M cost above the annual inflation rate specified on the [Financial Parameters](#) page. For an escalation rate of zero, the O&M cost in years two and later is the year one cost adjusted for inflation. For a non-zero escalation rate, the O&M cost in years two and later is the year one cost adjusted for inflation plus escalation.

For expenses such as component replacements that occur in particular years, you can use an annual schedule to assign costs to individual years. See below for details.

#### **Fixed annual cost (\$/yr)**

A fixed annual cost that applied to each year in the project cash flow.

#### **Fixed cost by capacity (\$/kW-yr)**

A fixed annual cost proportional to the system's rated or nameplate capacity.

#### **Variable cost by generation (\$/MWh)**

A variable annual cost proportional to the system's total annual electrical output in AC megawatt-hours. The annual energy output depends on either the performance model's calculated first year value and the **degradation rate** from the [Lifetime](#) page, or on an annual schedule of costs, depending on the option chosen.

For systems with include battery storage:

#### **Battery replacement cost**

The battery replacement cost in Year 1 dollars per kWh of installed battery capacity. SAM uses the inflation rate from the [Financial Parameters](#) page to calculate the replacement cost in the replacement year.

**Note.** To include battery replacements costs in your analysis, be sure to choose a battery replacement option on the [Battery Storage](#) page.

## ▼ Land-Based Balance of System Cost LandBOSSE Model

The Land-Based Balance of System cost model is an implementation of NREL's LandBOSSE model Costs inputs apply only when you choose the **Land-based installation** option under **Capital Cost Models**. SAM applies the results of the BOS cost model to the **Balance of System Cost** input when you click **Apply BOS Estimate**.

For information and references about the NREL LandBOSSE model in SAM, see the "Wind Cost Data" section of the [Wind page on the SAM website](#). Those materials include:

- Eberle, A.; Roberts, O.; Key, A.; Bhaskar, P.; Dykes, K. (2019) NREL's Balance-of-System Cost Model for Land-Based Wind. National Renewable Energy Laboratory. 62 pp. NREL/TP-6A20-72201. ([PDF 3.0 MB](#))
- LandBOSSE in SAM (Tutorial/Documentation). Description of the LandBOSSE implementation in SAM. ([PDF 603 KB](#))
- [LandBOSSE source code on GitHub](#).

**Note.** The LandBOSSE cost model runs separately from the SAM simulation. The cost model calculates a cost estimate that you can use for SAM's balance of system cost input in the Capital Costs section at the top of the System Costs page. The SAM simulation uses the value of that input in the financial model's cash flow calculations.

## Enable LandBOSSE Model

The first time you check Enable Land-Based Balance of System Cost Model, SAM installs the NREL LandBOSSE BOS cost model. Once the cost model is installed, when you check the box, SAM enables the BOS model inputs.

**Note.** It may take a few minutes to install the LandBOSSE model. After the model is installed, it takes a few moments to run, so be prepared to wait after clicking **Enable Land-Based Balance of System Cost Model**, **Calculate BOS**, or **Apply BOS Estimate**.

## Balance of System Model Inputs

To enable these inputs, click **Enable Land-Based Balance of System Cost Model**.

- For a detailed description of these inputs and instructions for using the LandBOSSE model, see "LandBOSSE in SAM (Tutorial/Documentation)", a description of the LandBOSSE model implementation in SAM. ([PDF 603 KB](#))

### Interconnect voltage, kV

The voltage at the interconnection point between the project substation and the interconnecting utility substation.

### Distance to interconnect, miles

The distance between the substation and point of interconnection with the grid.

### Turbine foundation depth, m

The depth of the turbine foundation. The LandBOSSE model uses costs for a shallow spread-foot foundation design.

### Turbine rated thrust, N

The maximum force experienced by the wind turbine under extreme conditions. This affects the foundation cost.

### Labor cost multiplier

Multiplier for all labor costs in the model.

### 50-year gust velocity, m/s

Wind velocity for the extreme 50-year wind gust at the project site.

### Calculate BOS

After you have entered values for the model inputs, click **Calculate BOS** to run the model and calculate a balance-of-system cost estimate. It may take a few moments for the model to run. When the model finishes, it populates values under **Balance of System Model Results** and **Balance of System Model Detailed Results**.

If you want to use the calculated cost estimate for your SAM simulation, click **Apply BOS estimate**.

## Balance of System Model Results

After you click **Calculate BOS**, when the LandBOSSE model finishes running, it displays the total BOS cost estimate along with cost details from the model.

### Total BOS Cost Estimate, \$

The total balance of system cost estimate calculated by the LandBOSSE model.

### BOS Cost Estimate per kW

The cost estimate in dollars per kW of nameplate capacity. When you click **Apply BOS Estimate**, SAM copies this value to the balance of system cost input under **Capital Costs**.

### Apply BOS Estimate

Click to replace the balance of system "cost per kW" SAM cost input under **Capital Costs** with the BOS cost estimate calculated by the LandBOSSE model. This sets the balance of system "cost per turbine" and "fixed cost" to zero.

### Rock Trenching Required

The percentage of total gravel/rock thermal backfill required to optimize soil thermal resistivity for collector cabling.

### Contingency

A percentage of the BOS total costs set aside for unexpected costs that occur during the construction period.

### Warranty Management

The cost of personnel to manage contracts during the warranty period and make any required claims as a percentage of the total balance of system costs.

### Sales and Use Tax

Taxes on projects vary dramatically by counties and states, with some having Renewable Energy Zones without taxes. For more information on sales and use taxes in the United States, see the [Tax Foundation](#) and [DSIRE USA](#) websites.

### Overhead

Percentage of the project budget for overhead costs such as administration, trailer rental, utilities, etc.

### Profit Margin

Percentage of the BOS project that is being considered as the project profit margin for the BOS activities.

### Development Fee

This is the accumulation of different costs of developing a project such as real estate, wind resource study, interconnection costs, environmental and permitting, etc. This could also include project profits created by the sale of the project from one developer to another developer.

## Balance of System Detailed Results

The detailed results shows the cost breakdown of results from the LandBOSSE model. For details, see "LandBOSSE in SAM (Tutorial/Documentation)", a description of the LandBOSSE model implementation in SAM. ([PDF 603 KB](#)).

## Offshore Balance of System Cost Model

The offshore balance of system cost model is for a wind farm installed offshore, in a body of water such as coastal ocean waters or lake. The model calculates a value for the **Balance of System** cost input in \$/kW based on the data you provide for the detailed costs.

For a description of the model and its inputs, see Maness, M.; Maples, B.; Smith, A.; NREL Offshore Balance-of-System Model. National Renewable Energy Laboratory, NREL/TP-6A20-66874. ([PDF 4.7 MB](#)).

After you specify values for the detailed inputs, click **Apply BOS Estimate** to calculate the BOS cost and automatically apply it to the **Balance of System Cost**.

# 11 Marine Energy Wave

The marine energy wave model is for a system that uses a wave energy converter (WEC) to convert the energy of ocean waves into electricity. The model requires the following inputs:

- A table of wave height versus wave energy period to characterize the [wave resource](#).
- Performance parameters for the [wave energy converter](#).
- A table of x-y positions if the system is an [array](#) of multiple WECs.
- Data specifying expected [losses](#) due to array spacing, resource prediction uncertainty, electrical transmission, and other sources.
- Installation and operating [costs](#) for levelized cost of energy (LCOE) calculations (optional).
- [Financial parameters](#) for LCOE calculations (optional).

SAM's built-in libraries provide default data for sample systems and locations. You can run the model with this default data or provide your own. The [wave resource library](#) includes resource data for a few locations in the United States:

- California Central Coast
- California Humboldt Bay
- Oregon
- North Carolina
- Hawaii

The [WEC library](#) includes parameters for three types of WECs:

- Heaving buoy
- Oscillating surge weave converter
- Backward bent duct buoy floating oscillating column

The WECs in the library are based on open-source wave energy point designs as part of the Reference Model Project (RMP) sponsored by the U.S. Department of Energy (DOE).

SAM's marine energy wave performance model is coupled with the LCOE Calculator to facilitate calculating the levelized cost of energy (LCOE) using an approach consistent with the method discussed in LaBonte, A. et al. (2013).

## Marine Energy References

- Dallman, A.; Neary, V. (2014) Characterization of U.S. Wave Energy Converter (WEC) Test Sites: A Catalogue of Met-Ocean Data. 125 pp.; SAND2014-18206. Sandia National Laboratories. ([PDF 8 MB](#))
- LaBonte, A. et al. (2013). [Standardized cost and performance reporting for marine and hydrokinetic technologies](#). 11 pp. Proceedings of 1st Marine Energy Technology Symposium, Washington DC.

For information about sources of wave energy resource data, see the following websites:

- [OpenEI NREL Wave Energy Assessment for the United States and Puerto Rico](#)
- [Marine Energy Data from NREL](#)

## 11.1 Wave Resource

The Wave Resource page provides information about the annual probability distribution of sea states at a given location. The sea state is the significant wave height ( $H_s$ ) and wave energy period ( $T_e$ ) at a particular time. A table showing the frequency of occurrence of sea states is called a joint probability distribution and can be used to make a wave resource scatter plot. For more about wave energy resource data and its application for wave energy converter modeling, see:

- Dallman, A.; Neary, V. (2014) Characterization of U.S. Wave Energy Converter (WEC) Test Sites: A Catalogue of Met-Ocean Data. 125 pp.; SAND2014-18206. Sandia National Laboratories. ([PDF 8 MB](#))
- LaBonte, A. et al. (2013). [Standardized cost and performance reporting for marine and hydrokinetic technologies](#). 11 pp. Proceedings of 1st Marine Energy Technology Symposium, Washington DC.

For information about sources of wave energy resource data, see the following websites:

- [Marine Energy Data Repository](#)
- [OpenEI NREL Wave Energy Assessment for the United States and Puerto Rico](#)
- [Marine Energy Data from NREL](#)

You can either choose a wave resource file from SAM's library, or choose a properly formatted wave energy resource file from your computer. For information about SAM's wave resource file format, see [CSV Format for Marine Energy](#).

### Wave Energy Resource Library

The wave energy resource library is a collection of wave energy resource files for a few locations in the United States that comes with your SAM installation.

**Note.** See [Managing Wave Energy Resource Files](#) for more information about how data in the library is stored.

#### **To choose a file from the wave energy resource library:**

- Click an item in the list.  
You can click a column heading in the list to sort the library.

When you choose an item from the library, SAM updates the wave energy resource scatter diagram with data from the file.

SAM also shows dominant wave parameters calculated from the data in the diagram for reference. You can also use the color coding of the table to identify the dominant wave parameters.

**Probability of dominant wave**

The maximum frequency of occurrence in the resource scatter diagram.

**Dominant wave height, m**

The significant wave height in meters of the maximum frequency of occurrence in the diagram.

**Dominant wave period, s**

The wave energy period in seconds of the maximum frequency of occurrence in the diagram.

**Frequency sum, %**

The sum of frequency of occurrence values in the diagram. The sum should be 100%, but may vary slightly from 100 due to rounding error.

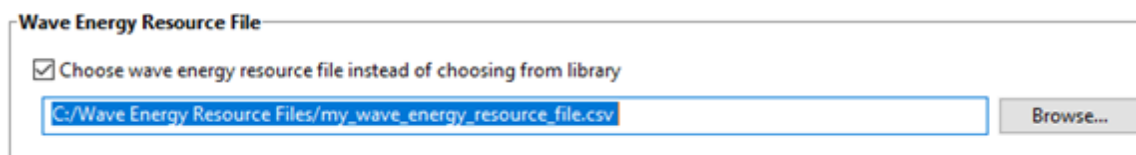
## Wave Energy Resource File

If you have a [properly formatted](#) wave energy resource file, you can use it instead of choosing a file from the library.

**Note.** SAM can only display the resource scatter diagram and other parameters for files in the wave energy resource library. When you choose a file that is not in the library, SAM uses the frequency distribution data from the file, not the data shown in the table. SAM generates a frequency of distribution table in the simulation results ([Data Tables](#), [Matrix Data](#), [Frequency distribution of resource](#)), so you can always see the data after running a simulation, regardless of whether you use a resource file from the library.

**To choose a wave energy resource file from your computer:**

1. Check the box under Wave Energy Resource File.
2. Click **Browse** and navigate to the file.



Wave Energy Resource File

Choose wave energy resource file instead of choosing from library

C:/Wave Energy Resource Files/my\_wave\_energy\_resource\_file.csv

Browse...

## Managing Wave Energy Resource Files

If you have a collection of wave energy resource files, you can either store them anywhere on your computer and use the Wave Energy Resource file check box to choose them for SAM simulations, or you can add special library versions of the files to the wave energy resource library folder.

For examples of wave energy resource files, see the [SAM website](#).

To avoid potentially losing your wave energy resource files when you remove SAM or update it to a new version, you should use the check box option. However, if you want add your files to SAM's library so you can choose them from the list and see the frequency of occurrence data in the table, you may choose to add the files to the library. To do so, close SAM, and put copies of the files in the *wave\_resource* folder of your [SAM installation](#). The next time you start SAM, you should see your files in the library list.

**Notes.**

The wave energy resource library requires a special file format with two extra rows as described in Weather File Formats.

If you do decide to store your wave resource files in your SAM installation's *wave\_resource* folder so you can choose them from the library, and you encounter errors loading the library about "invalid stod argument," use the [CSV for marine energy file format description](#) to check the file for formatting errors such as using strings for fields that require numbers.

## 11.2 Wave Energy Converter

SAM's wave energy converter (WEC) model uses an electrical power capture matrix to characterize the performance of the converter. This matrix can be generated by a time-domain numerical simulation model such as the open source [WEC-Sim](#) (Wave Energy Converter Simulation) MATLAB/SIMULINK model. The matrix maps electrical power capture to the significant wave height and peak period in the wave resource scatter diagram on the [Wave Resource](#) page and should use the same bin size. The WEC modeling approach is consistent with the method described in LaBonte, A. et al. (2013). [Standardized cost and performance reporting for marine and hydrokinetic technologies](#). 11 pp. Proceedings of 1st Marine Energy Technology Symposium, Washington DC.

Unlike SAM's other performance models, the wave energy converter model does not perform a time series simulation of the system's performance so it does not generate hourly or subhourly time series results over the year like the other models.

You can either choose a wave power matrix from the wave energy converter library, or you can import the data from a text file or other program.

### WEC Library

SAM's wave energy converter library stores power matrix data and some descriptive information for different types of WECs.

WECs included in the library are based on open-source marine energy point designs as part of the Reference Model Project (RMP), sponsored by the U.S. Department of Energy (DOE). The included reference models are:

- Reference Model 3: Wave Point Absorber
- Reference Model 5: Oscillating Flap
- Reference Model 6: Oscillating Water Column

Related studies and supporting documentation for each reference model is located on the [DOE Reference Model Project website](#).

#### To choose an WEC from the library:

1. Click **Choose WEC from library**.
2. Click the item in the library.

SAM populates the power matrix table with data from the library and shows converter attributes in the table.



**Tip.** You can select the data in the table by holding down the Shift key and using the up and down arrows to select the entire table. Then press Control-C (or Command-C on a Mac) to copy the data to your clipboard.

## Import WEC Power Matrix Data

To model a WEC not found in the library, you can import its power matrix data from a file.

See the [SAM website](#) for a sample WEC data file.

The WEC power matrix is a table of electrical power in kW for a range of significant wave heights in meters and wave energy periods in seconds with bins that match the wave energy resource scatter diagram on the [Wave Resource](#) page. You can either type values into the table by hand, import data from a comma-separated (CSV) text file, or paste data from your computer's clipboard.

### To import WEC power matrix data:

1. Click **Import WEC parameters**.
2. To import the data from a file, click **Import**.
3. To paste the data from the clipboard, click **Paste**. Paste works with tab-delimited data so you can paste from a spreadsheet program.

The file format for the WEC power matrix is as follows:

- Columns are separated by commas.
- Row 1 contains the peak wave energy period (Te) value in seconds for each bin. The first column of Row 1 is ignored.
- Column 1 contains the significant wave height (Hs) value in meters for each bin. The first row of Column 1 is ignored.
- The remaining data is the WEC electrical power output in kW for each Te, Hs pair.

```

wec_power_matrix.csv
1 0,0.5,1.5,2.5,3.5,4.5,5.5,6.5,7.5,8.5,9.5,10.5,11.5,12.5,13.5,14.5,15.5,16.5,17.5,18.5,19.5,20.5
2 0.25,0,0,0,0,0.4,0.6,0.8,1,1.1,1.1,1,0.8,0.7,0.6,0.5,0.4,0.3,0.3,0.2,0.2,0
3 0.75,0,0,0,0,3.2,5.3,7.4,9.1,9.8,9.5,8.6,7.4,6.2,5.1,4.1,3.4,2.8,2.3,1.9,1.6,0
4 1.25,0,0,0,0,9,14.8,20.5,25,26.8,25.9,23.3,20,16.8,13.8,11.3,9.2,7.6,6.3,5.2,4.3,0
5 1.75,0,0,0,0,17.6,28.9,39.9,48.3,51.6,49.7,44.7,38.4,32.2,26.5,21.7,17.8,14.6,12.1,10.8,4,0
6 2.25,0,0,0,0,29,47.5,65.4,78.8,83.8,80.6,72.4,62.3,52.2,43,35.3,28.9,23.8,19.7,16.3,13.7,0
7 2.75,0,0,0,0,43.2,70.7,97,116.3,123.1,118.1,106.1,91.3,76.5,63.2,51.9,42.5,35,28.9,24.1,20.1,0
8 3.25,0,0,0,0,60.2,98.3,134.5,160.5,169.3,162.1,145.5,125.2,105,86.8,71.3,58.5,48.2,39.9,33.2,27.8,0
9 3.75,0,0,0,0,79.9,130.4,177.8,211.2,222,212.2,190.4,164,137.6,113.8,93.6,76.9,63.3,52.5,43.7,36.6,0
10 4.25,0,0,0,0,102.4,166.7,226.7,268.3,281.1,268.2,240.5,207.2,174.1,144.1,118.5,97.4,80.3,66.6,55.5,46.5,0
11 4.75,0,0,0,0,127.6,207.4,281.2,286,286,286,286,255,214.3,177.5,146.1,120.2,99.2,82.2,68.6,57.6,0
12 5.25,0,0,0,0,155.4,252.4,286,286,286,286,286,286,258.2,214,176.3,145.1,119.8,99.4,83,69.7,0
13 5.75,0,0,0,0,186,286,286,286,286,286,286,286,253.6,209,172.2,142.2,118.1,98.6,82.8,0
14 6.25,0,0,0,0,219.2,286,286,286,286,286,286,286,286,244.2,201.2,166.4,138.2,115.5,97.1,0
15 6.75,0,0,0,0,255,286,286,286,286,286,286,286,286,286,281.9,232.4,192.2,159.7,133.5,112.3,0
16 7.25,0,0,0,0,286,286,286,286,286,286,286,286,286,286,265.6,219.8,182.8,152.9,128.7,0
17 7.75,0,0,0,0,286,286,286,286,286,286,286,286,286,286,286,249,207.2,173.4,146,0
18 8.25,0,0,0,0,286,286,286,286,286,286,286,286,286,286,286,286,279.9,233,195.1,164.4,0
19 8.75,0,0,0,0,286,286,286,286,286,286,286,286,286,286,286,286,286,260.2,218,183.8,0
20 9.25,0,0,0,0,286,286,286,286,286,286,286,286,286,286,286,286,286,286,242.1,204.1,0
21 9.75,0,0,0,0,286,286,286,286,286,286,286,286,286,286,286,286,286,286,286,286,267.4,225.6,0
22

```

## 11.3 Array

You can model a system with a single device or more than one device.

### System Sizing

Use the system sizing options to determine how to size the system.

#### Use a single device

Model the system as a single device.

#### Specify desired rated capacity

Automatically determine the number of devices based on a desired system capacity in kW. SAM attempts to find a number of devices that meets the desired array capacity you enter. The capacity of a single device is determined by the parameters on the [Wave Energy Converter](#) or [Tidal Energy Converter](#) page.

#### Specify number of devices

Use this option to define an array of devices by specifying the number of rows and devices per row under **Array Layout**.

### Array Layout

The Array Layout parameters define the relative positions of devices when there is more than one device, and the lengths of electrical cable connecting the array to the shore. SAM can only model devices arranged in rectangular arrays.

**Note.** The array layout parameters are used to calculate cable lengths for cost calculations on the System Costs page. These parameters do not affect estimates of electrical losses on the Losses page.

#### Number of rows

Number of device rows perpendicular to the wave direction.

#### Devices per row

For arrays of more than one device, the number of devices in each row.

#### Spacing between devices in a row, m

Distance between devices in each row in meters. This variable is hidden when there is a single device in the system.

#### Row spacing

The distance between rows in meters. This variable is hidden when there is a single device in the system.

#### Distance to shore, m

The distance between the edge of the array closest to the shore and the shoreline in meters. Used to calculate the export cable cost on the System Costs page.

#### Water depth, m

The average depth of water in the array in meters.

#### Cable system overbuild, %

Overbuild margin for export and array cable.

### Floating array

Determines whether riser cable is included in the system. Riser cable is only required for floating arrays.

### Build export cable redundancy

Adds extra length to export cable length, assuming two export cables instead of one.

## Calculated Cable Lengths

The calculated cable length values are determined from the array layout parameters and used to calculate cable costs on the System Costs page. All lengths are in meters.

### Inter-array cable length, m

The total length of cable used within the array of devices.

$$\text{Cable Length} = (\text{Devices per Row} - 1) \times \text{Spacing Between Devices in a Row} \times \text{Number of Rows} + \text{Row Spacing} \times (\text{Number of Rows} - 1)$$

This length is adjusted to meet the **Cable system overbuild** requirement:

$$\text{Adjusted Cable Length} = \text{Cable Length} \times (1 + \text{Cable System Overbuild} / 100\%)$$

### Export cable length, m

The length of cable between the array and onshore grid connection point.

$$\text{Cable Length} = (\text{Water Depth} + \text{Distance to Shore}) \times (1 + \text{Cable System Overbuild} / 100\%)$$

If you choose the **Build export redundancy** option:

$$\text{Cable Length with Redundancy} = (\text{Water Depth} + 2 \times \text{Distance to Shore}) \times (1 + \text{Cable System Overbuild} / 100\%)$$

### Riser cable length, m

The length of cable from the seabed to the water surface that connects the floating device to the seabed cabling. Applies only when you choose the **Floating array** option.

$$\text{Riser Cable Length} = 1.5 \times \text{Water Depth} \times \text{Number of Devices} \times (1 + \text{Cable System Overbuild} / 100\%)$$

## 11.4 Losses

SAM applies the total loss to the annual energy production of the system. The total loss percentage is the sum of the different loss categories.

The default 2% transmission loss and a 5% array/device downtime loss are based on the [reference model project](#).

## 11.5 Capital and O&M Costs

SAM's marine energy models for wave and tidal power use a fixed-charge-rate (FCR) method to calculate the levelized cost of energy (LCOE) from inputs on the [Financial Parameters](#) page. The FCR method requires a total installed cost and annual operating cost value as input, along with a fixed charge rate representing the financial assumptions for the project.


For the marine energy models, each Capital Costs page and the O&M (operation and maintenance) Cost page provide a detailed cost structure that SAM uses to calculate the total capital cost and fixed annual operating cost for the LCOE calculation:

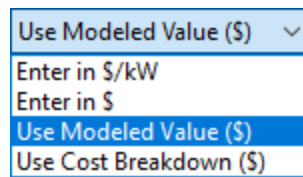
- The total capital cost is the sum of the total device cost, total balance of system (BOS) cost, and total financial cost.
- The fixed operating cost is the sum of the O&M costs.

The cost structure has several levels, so you can specify each cost as a single value, or break it down into more detailed categories and subcategories.

### Override cost structure

This is the highest level in the cost structure. Use this option to enter a total cost at the Device, BOS, Financial, or O&M Cost level. When you check **Override cost structure**, SAM uses the value you type and ignores the detailed cost values.

If you choose to enter costs using more detailed categories, for each cost, click the Expand button  to show details, and choose an option for entering cost values:



### Enter in in \$/kW

Type a cost per unit of rated capacity. The rated capacity is from the Array page. SAM calculates the category cost by multiplying the "user input" cost you enter in \$/kW by the array capacity in kW from the Array page. SAM ignores the modeled value, but shows it for your reference.

	Modeled value	User input	Category cost
<b>Structural assembly</b>	\$249,857,808	7,000	\$252,000,000

**System Sizing**

Use a single device  
 Specify desired rated capacity  
 Specify number of devices

Number of devices in array:   
 Rated array capacity:  kW

Specify the number of devices using the Array Layout parameters below.

*Note: Arrows in the image show that 7,000 \$/kW multiplied by 36,000 kW equals 252,000,000.*

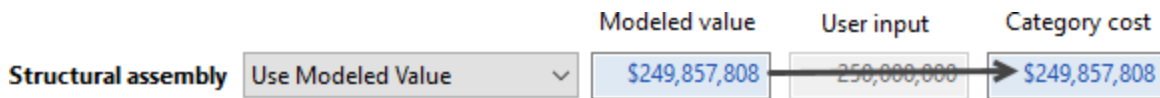
### Enter in \$

Type a dollar value for the cost. SAM ignores the modeled value, but shows it for your reference.

	Modeled value	User input	Category cost
<b>Structural assembly</b>	\$249,857,808	250,000,000	\$250,000,000

**Use Modeled Value (\$)**

Choose this option for SAM to automatically calculate the cost. The category cost is equal to the modeled value, and SAM ignores the "user input" value.



**Note about modeled values.** For the wave energy model, if you choose a WEC from the library on the Wave Energy Converter page, the default device costs are based on the associated costs for each design based on reference model projects. Balance of system costs and financial costs are based on costs curves developed from existing reference model data, a database with wave and tidal cost data from DOE-funded projects, and a literature review of wave, tidal, and offshore wind energy costs.

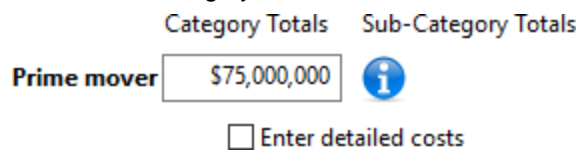
If you use your own WEC parameters instead of choosing a WEC from the library, device costs are from cost curves based on array rated power or percentage of costs. These costs curves were developed from existing reference model data, a database with wave and tidal cost data from DOE-funded projects, and a literature review of wave, tidal, and offshore wind energy costs.

For the tidal energy model, default device costs are based on the associated costs the Reference Model 1 tidal converter. Balance of system capital costs and financial costs are based on costs curves developed from existing reference model data, a database with wave and tidal cost data from DOE-funded projects, and a literature review of wave, tidal, and offshore wind energy costs.

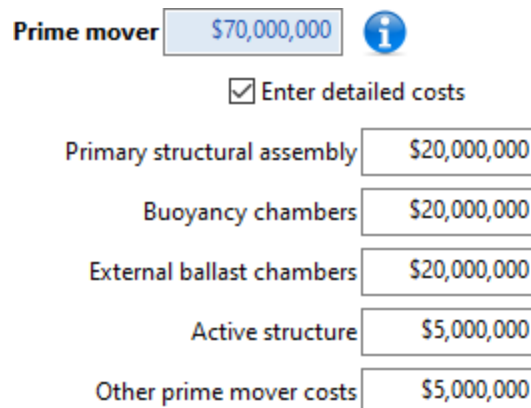
**Use Cost Breakdown (\$)**

Choose this option to enter costs at the most detailed level. When you choose the option for a cost category, SAM automatically expands the Cost Breakdown section for that category.

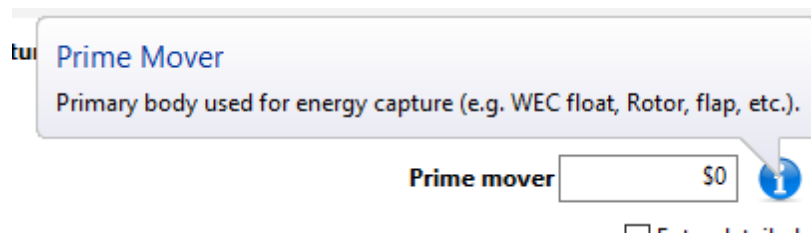
You can either enter a total cost for the category,



or check **Enter detailed costs** to enter itemized costs for each subcategory. SAM automatically calculates the total based on the costs you enter.



For information about a cost item, click the Information button next to the item's label.



## 12 Marine Energy Tidal

The marine energy tidal model is for a system that uses a tidal energy converter (TEC) to convert the energy of ocean tides into electricity. The model requires the following inputs:

- A table of tidal current flow versus column depth to characterize the [tidal resource](#).
- A table of electrical power versus tidal current flow [tidal energy converter](#).
- A table of x-y positions if the system is an [array](#) of multiple TECs.
- Data specifying expected [losses](#) due to array spacing, resource prediction uncertainty, electrical transmission, and other sources.
- Installation and operating [costs](#) for levelized cost of energy (LCOE) calculations (optional).
- [Financial parameters](#) for LCOE calculations (optional).

SAM's marine energy tidal performance model is coupled with the LCOE Calculator to facilitate calculating the levelized cost of energy (LCOE) using an approach consistent with the method discussed in LaBonte, A. et al. (2013).

### Marine Energy References

- Dallman, A.; Neary, V. (2014) Characterization of U.S. Wave Energy Converter (WEC) Test Sites: A Catalogue of Met-Ocean Data. 125 pp.; SAND2014-18206. Sandia National Laboratories. ([PDF 8 MB](#))
- LaBonte, A. et al. (2013). [Standardized cost and performance reporting for marine and hydrokinetic technologies](#). 11 pp. Proceedings of 1st Marine Energy Technology Symposium, Washington DC.

For information about sources of wave energy resource data, see the following websites:

- [Marine Energy Data from NREL](#)

## 12.1 Tidal Resource

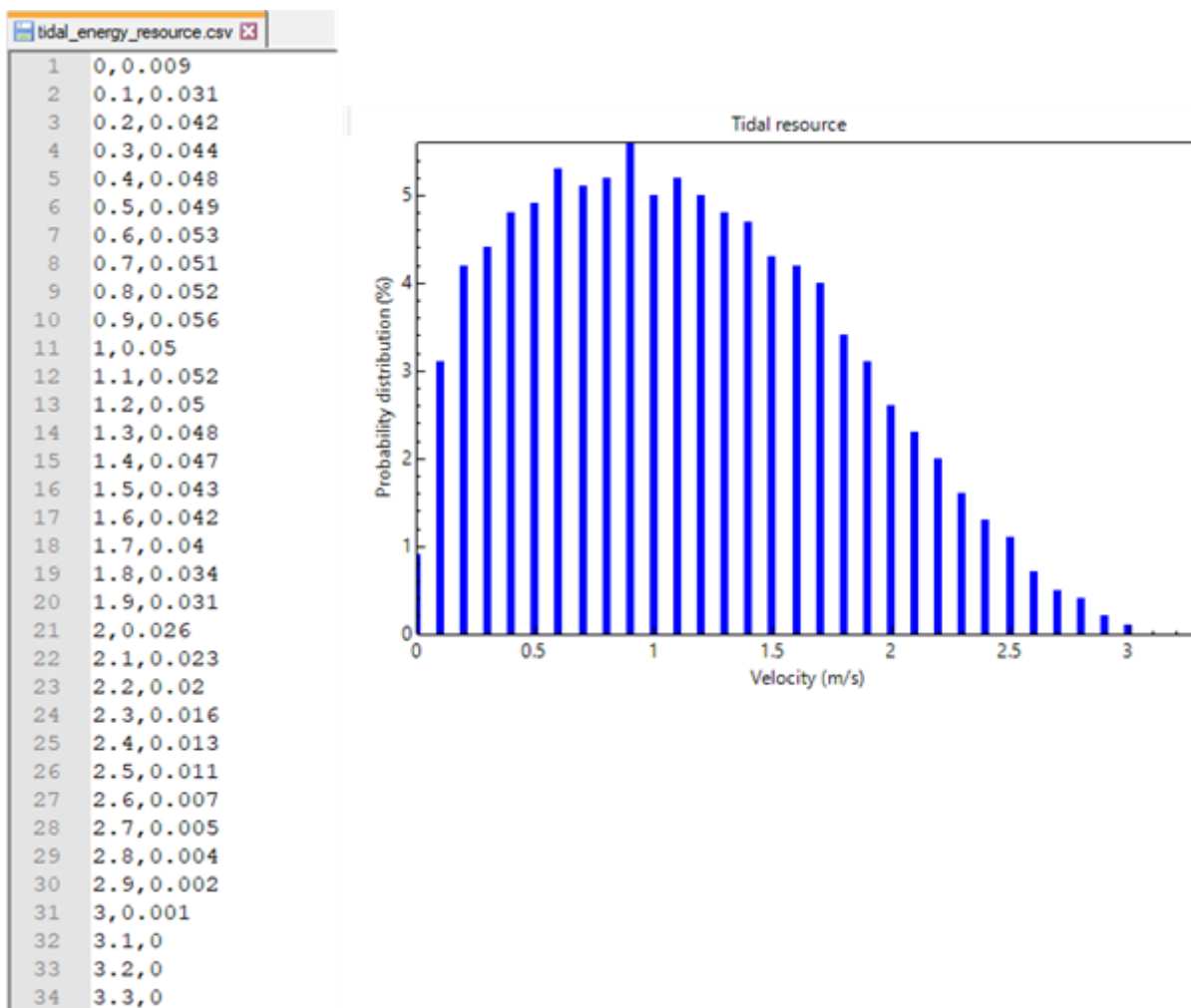
The tidal energy resource is characterized by a probability distribution function of surface tidal current velocities in meters per second.

You can import tidal resource data from a text file, paste it from your computer's clipboard, or type values by hand in the tidal resource table.

The tidal energy resource file format is a simple comma-separated (CSV) text file with two columns and no headers. The first column is the surface current velocity in meters per second (m/s), and the second column is the probability distribution fraction for each velocity.

**Note.** The probability distributions in the CSV file should be fractions, not percentages. SAM displays the values in the probability distribution graph as percentages, but the data in the table should be fractions.

The following screenshot shows a tidal energy resource file with the resulting probability distribution curve plotted in SAM.



**To import tidal energy resource data:**

- Click Import and navigate to the file.

**To paste tidal energy resource data from the clipboard:**

1. Select the data in a spreadsheet program and copy it to your clipboard. The data should consist of two columns of tab-delimited surface velocity and probability fraction values.
2. In SAM, on the Tidal Resource page, click **Paste**.

## 12.2 Tidal Energy Converter

The tidal energy converter (TEC) is characterized by a power curve derived from a table of tide velocities in meters per second (m/s) and electrical power in kilowatts (kW). The power should be the net electrical power at the TEC device output terminals accounting for power used by onboard electrical systems.

The default tidal energy converter is based on open-source marine energy point designs as part of the Reference Model Project (RMP), sponsored by the U.S. Department of Energy (DOE): [Reference Model 1: Tidal Current Turbine](#)

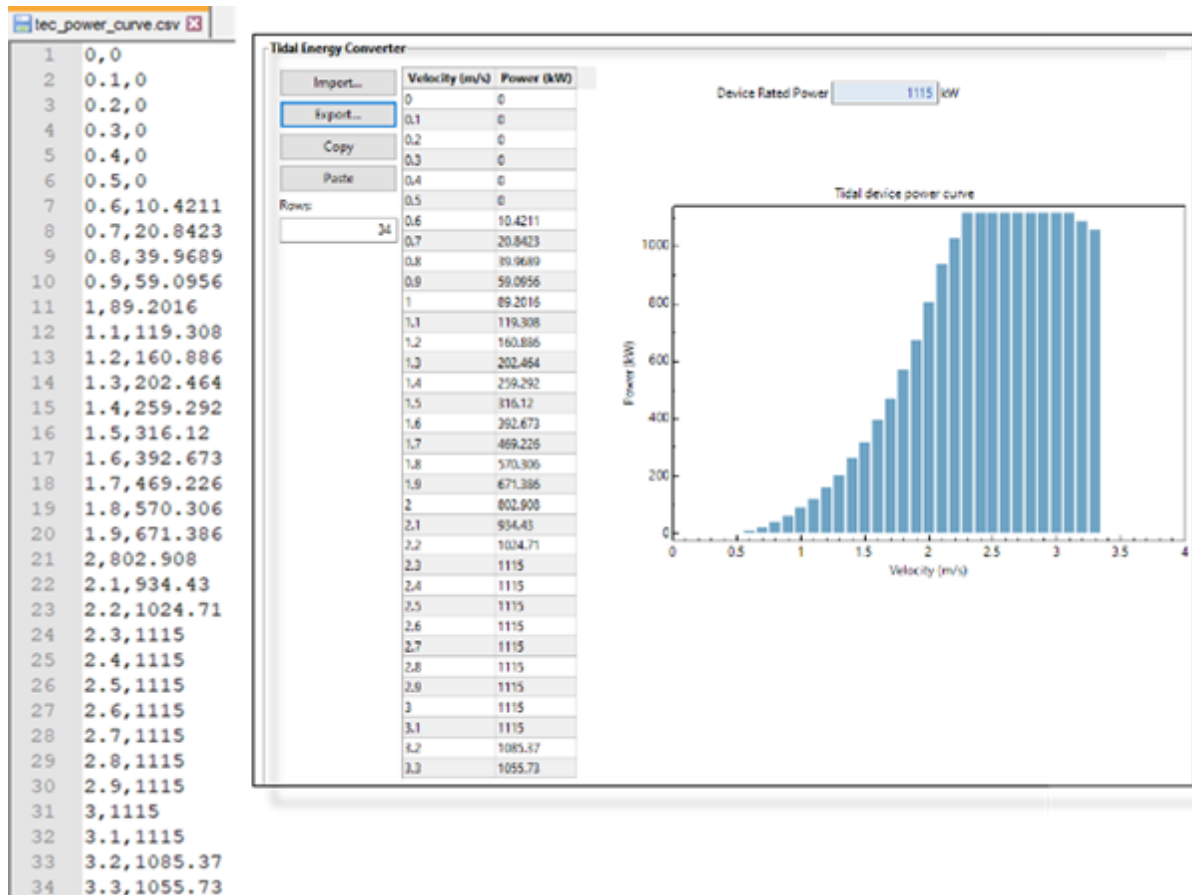
**To define TEC characteristics:**

- Import TEC power curve data from a text file, paste it from your computer's clipboard, or type values by hand in the tidal resource table.

The TEC power curve file format is a simple comma-separated (CSV) text file with two columns and no headers. The first column is the surface current velocity in meters per second (m/s), and the second column is net power output of the device in kilowatts (kW) at each velocity. For an example of a TEC data file, see the [SAM website](#).

The following screenshot shows a TEC power curve file and the resulting power curve imported to SAM.





### Device rated power

The device rated power is the maximum power value in the TEC power curve and determines the device and array rated power for cost calculations.

### To import tidal energy resource data:

- Click **Import** and navigate to the file.

### To paste tidal energy resource data from the clipboard:

- Select the data in a spreadsheet program and copy it to your clipboard. The data should consist of two columns of tab-delimited surface velocity and probability fraction values.
- In SAM, on the Tidal Resource page, click **Paste**.

## 12.3 Array

You can model a system with a single device or more than one device.

### System Sizing

Use the system sizing options to determine how to size the system.

**Use a single device**

Model the system as a single device.

**Specify desired rated capacity**

Automatically determine the number of devices based on a desired system capacity in kW. SAM attempts to find a number of devices that meets the desired array capacity you enter. The capacity of a single device is determined by the parameters on the [Wave Energy Converter](#) or [Tidal Energy Converter](#) page.

**Specify number of devices**

Use this option to define an array of devices by specifying the number of rows and devices per row under **Array Layout**.

**Array Layout**

The Array Layout parameters define the relative positions of devices when there is more than one device, and the lengths of electrical cable connecting the array to the shore. SAM can only model devices arranged in rectangular arrays.

**Note.** The array layout parameters are used to calculate cable lengths for cost calculations on the System Costs page. These parameters do not affect estimates of electrical losses on the Losses page.

**Number of rows**

Number of device rows perpendicular to the wave direction.

**Devices per row**

For arrays of more than one device, the number of devices in each row.

**Spacing between devices in a row, m**

Distance between devices in each row in meters. This variable is hidden when there is a single device in the system.

**Row spacing**

The distance between rows in meters. This variable is hidden when there is a single device in the system.

**Distance to shore, m**

The distance between the edge of the array closest to the shore and the shoreline in meters. Used to calculate the export cable cost on the System Costs page.

**Water depth, m**

The average depth of water in the array in meters.

**Cable system overbuild, %**

Overbuild margin for export and array cable.

**Floating array**

Determines whether riser cable is included in the system. Riser cable is only required for floating arrays.

**Build export cable redundancy**

Adds extra length to export cable length, assuming two export cables instead of one.

**Calculated Cable Lengths**

The calculated cable length values are determined from the array layout parameters and used to calculate cable costs on the System Costs page. All lengths are in meters.

#### Inter-array cable length, m

The total length of cable used within the array of devices.

$$\text{Cable Length} = (\text{Devices per Row} - 1) \times \text{Spacing Between Devices in a Row} \times \text{Number of Rows} + \text{Row Spacing} \times (\text{Number of Rows} - 1)$$

This length is adjusted to meet the **Cable system overbuild** requirement:

$$\text{Adjusted Cable Length} = \text{Cable Length} \times (1 + \text{Cable System Overbuild} / 100\%)$$

#### Export cable length, m

The length of cable between the array and onshore grid connection point.

$$\text{Cable Length} = (\text{Water Depth} + \text{Distance to Shore}) \times (1 + \text{Cable System Overbuild} / 100\%)$$

If you choose the **Build export redundancy** option:

$$\text{Cable Length with Redundancy} = (\text{Water Depth} + 2 \times \text{Distance to Shore}) \times (1 + \text{Cable System Overbuild} / 100\%)$$

#### Riser cable length, m

The length of cable from the seabed to the water surface that connects the floating device to the seabed cabling. Applies only when you choose the **Floating array** option.

$$\text{Riser Cable Length} = 1.5 \times \text{Water Depth} \times \text{Number of Devices} \times (1 + \text{Cable System Overbuild} / 100\%)$$

## 12.4 Losses

SAM applies the total loss to the annual energy production of the system. The total loss percentage is the sum of the different loss categories.

The default 2% transmission loss and a 5% array/device downtime loss are based on the [reference model project](#).

## 12.5 Capital and O&M Costs

SAM's marine energy models for wave and tidal power use a fixed-charge-rate (FCR) method to calculate the levelized cost of energy (LCOE) from inputs on the [Financial Parameters](#) page. The FCR method requires a total installed cost and annual operating cost value as input, along with a fixed charge rate representing the financial assumptions for the project.

For the marine energy models, each Capital Costs page and the O&M (operation and maintenance) Cost page provide a detailed cost structure that SAM uses to calculate the total capital cost and fixed annual operating cost for the LCOE calculation:

- The total capital cost is the sum of the total device cost, total balance of system (BOS) cost, and total financial cost.

- The fixed operating cost is the sum of the O&M costs.

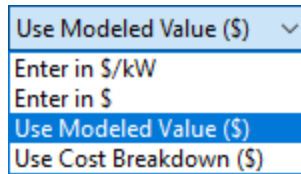
The cost structure has several levels, so you can specify each cost as a single value, or break it down into more detailed categories and subcategories.

**Override cost structure**

This is the highest level in the cost structure. Use this option to enter a total cost at the Device, BOS, Financial, or O&M Cost level. When you check **Override cost structure**, SAM uses the value you type and ignores the detailed cost values.



If you choose to enter costs using more detailed categories, for each cost, click the Expand button to show details, and choose an option for entering cost values:



**Enter in in \$/kW**

Type a cost per unit of rated capacity. The rated capacity is from the Array page. SAM calculates the category cost by multiplying the "user input" cost you enter in \$/kW by the array capacity in kW from the Array page. SAM ignores the modeled value, but shows it for your reference.

	Modeled value	User input	Category cost
Structural assembly	\$249,857,808	7,000	\$252,000,000

**System Sizing**

Use a single device  
 Specify desired rated capacity  
 Specify number of devices

Number of devices in array:  ×  
 Rated array capacity:  kW =

Specify the number of devices using the Array Layout parameters below.

**Enter in \$**

Type a dollar value for the cost. SAM ignores the modeled value, but shows it for your reference.

	Modeled value	User input	Category cost
Structural assembly	\$249,857,808	250,000,000	\$250,000,000

**Use Modeled Value (\$)**

Choose this option for SAM to automatically calculate the cost. The category cost is equal to the modeled value, and SAM ignores the "user input" value.

	Modeled value	User input	Category cost
Structural assembly	\$249,857,808	250,000,000	\$249,857,808

**Note about modeled values.** For the wave energy model, if you choose a WEC from the library on the Wave Energy Converter page, the default device costs are based on the associated costs for each design based on reference model projects. Balance of system costs and financial costs are based on costs curves developed from existing reference model data, a database with wave and tidal cost data from DOE-funded projects, and a literature review of wave, tidal, and offshore wind energy costs.

If you use your own WEC parameters instead of choosing a WEC from the library, device costs are from cost curves based on array rated power or percentage of costs. These costs curves were developed from existing reference model data, a database with wave and tidal cost data from DOE-funded projects, and a literature review of wave, tidal, and offshore wind energy costs.


For the tidal energy model, default device costs are based on the associated costs the Reference Model 1 tidal converter. Balance of system capital costs and financial costs are based on costs curves developed from existing reference model data, a database with wave and tidal cost data from DOE-funded projects, and a literature review of wave, tidal, and offshore wind energy costs.

**Use Cost Breakdown (\$)**

Choose this option to enter costs at the most detailed level. When you choose the option for a cost category, SAM automatically expands the Cost Breakdown section for that category.


You can either enter a total cost for the category,

Category Totals    Sub-Category Totals

Prime mover  

Enter detailed costs

or check **Enter detailed costs** to enter itemized costs for each subcategory. SAM automatically calculates the total based on the costs you enter.


Prime mover  

Enter detailed costs

Primary structural assembly	<input type="text" value="\$20,000,000"/>
Buoyancy chambers	<input type="text" value="\$20,000,000"/>
External ballast chambers	<input type="text" value="\$20,000,000"/>
Active structure	<input type="text" value="\$5,000,000"/>
Other prime mover costs	<input type="text" value="\$5,000,000"/>

For information about a cost item, click the Information button next to the item's label.

**Prime Mover**  
 Primary body used for energy capture (e.g. WEC float, Rotor, flap, etc.).

Prime mover  

## 13 Geothermal

SAM's geothermal power model is based on the U.S. Department of Energy's Geothermal Electricity Technology Evaluation Model (GETEM), <https://energy.gov/eere/geothermal/geothermal-electricity-technology-evaluation-model>. The model calculates the annual and lifetime electrical output of a utility-scale geothermal power plant, and the levelized cost of energy (LCOE) and other economic metrics for the plant.

For more details about the model, please refer to the documentation for the U.S. Department of Energy's Geothermal Electricity Technology Evaluation Model (GETEM), which you can download from <https://energy.gov/eere/geothermal/getem-manuals-and-revision-notes>

The geothermal power model calculates the output of a power plant that uses heat from below the surface of the ground to drive a steam electric power generation plant. SAM analyzes the plant's performance over its lifetime, assuming that changes in the resource and electrical output occur monthly over a period of years.

SAM can be used to answer the following kinds of questions:

- What is the levelized cost of energy (LCOE) for a geothermal power plant, given a known configuration and resource?
- How does changing the design of the plant affect its output and LCOE?
- What plant size is required to meet an electric capacity requirement?
- Given a known number of wells, what would the plant's electric capacity be?

SAM models the following types of systems:

- Hydrothermal resources, where the underground heat reservoir is sufficiently permeable and contains sufficient groundwater to make the resource useful without any enhancements.
- Enhanced geothermal systems (EGS) that pump water or steam underground to collect heat stored in rock. These systems involve drilling or fracturing the rock to improve heat transfer. Over time (typically years), as heat is collected from the rock, its temperature decreases, and more drilling is required. SAM's recapitalization cost accounts for the cost of these improvements to reach new resources.
- Both flash and binary conversion plants.

### 13.1 Ambient Conditions

The Ambient Conditions page allows you to choose a weather file to specify ambient conditions for the [geothermal](#) system's power block model when you specify either **Power Block Monthly** or **Power Block Hourly** as the Model option on the Power Block page.

The geothermal resource is specified on the [Resource](#) page.

**Important Note!** You do not need to specify a weather file with the GETEM power block option. With the GETEM power block option, SAM ignores the weather file you choose on the Ambient Conditions page.

The geothermal performance model runs a simulation over the life of the plant (defined by **Analysis Period** on the Financial Parameters page) in order to account for the annual decline in resource temperature. SAM assumes that the data in the weather file represents typical ambient conditions at the power block over the entire analysis period. Because the weather file contains data for a single year, SAM reads data from the weather file multiple times to complete the multi-year simulation:

- For an hourly simulation (**Power Block Hourly** option on the [Power Block](#) page), SAM reads hourly data from the weather file, and uses it to represent ambient conditions in each hour for each year of the analysis period. For example, for an analysis period of 30 years, SAM would use the same temperature, pressure, and humidity values for each July 2nd at 2 pm for each of the 30 years.
- For a monthly simulation (**Power Block Monthly** option on the [Power Block](#) page), SAM calculates average temperature, pressure, and humidity values from the hourly values in the weather file, and uses them to represent the average ambient conditions for each month of the year. SAM uses the same set of twelve monthly average values for each year of the plant's life.

## 13.2 Geothermal Resource

### Resource Characterization

The resource characterization inputs describe the energy available in the underground geology at the project site.

#### Resource Type

For **Hydrothermal** resources, the rocks have enough permeability, heat, and water to be useful immediately.

For **Enhanced Geothermal System (EGS)** resources, there is heat, but either water, or permeability, or both are missing and must be added during the project development and operation.

#### Total Resource Potential

The total resource potential is an estimate of the total size of the energy available in the underground thermal reservoir. SAM uses the value to calculate the number of times over the project life that new drilling would be required to renew the resource based on the reduction of the reservoir's temperature over time. As the system operates and draws heat from the reservoir, the reservoir temperature drops. After a number of years, there may be insufficient heat to maintain the steam temperature required to drive the plant, and new wells may need to be drilled to renew the resource by reaching another section of the reservoir where there is sufficient heat. Eventually, the reservoir may cool to the point that it is impossible to find more heat by drilling from the plant location. Total resource potential is meant to be a measure of how many times the reservoir can be renewed. For example, a 210 MW reservoir divided by 30 MW plant capacity could support up to seven renewals ( $210 \div 30 = 7$ ).

#### Resource Temperature

The temperature of the reservoir at the depth given by the resource depth.

#### Resource Depth

The depth below ground at which the temperature specified by the resource temperature exists.

**Note.** In general, the higher the temperature of the resource, the lower the cost of energy generated by the plant. However, SAM does not handle systems that operate at extremely high steam temperatures that require special equipment.

For a description of the resource characterization inputs, see page 2 of the "Revisions to GETEM Spreadsheet (Version 2009-A15)" document available at <https://energy.gov/eere/geothermal/getem-manuals-and-revision-notes>.

## Reservoir Parameters

The reservoir parameters describe the geologic formation. SAM provides three options for calculating the change in reservoir pressure. The option you choose affects the plant's overall efficiency, which depends on the design parameters that SAM displays under **Calculated Design**. The design value determines the pumping power or parasitic load required by the plant.

For a description of the reservoir parameters, see page 6 of the "Revisions to GETEM Spreadsheet (Version 2009-A15)" document available at <https://energy.gov/eere/geothermal/getem-manuals-and-revision-notes>.

## 13.3 Plant and Equipment

**Note.** This topic is still under development.

For more details about SAM's geothermal model, please refer to the documentation for the U.S. Department of Energy's Geothermal Electricity Technology Evaluation Model (GETEM), which you can download from <https://energy.gov/eere/geothermal/getem-manuals-and-revision-notes>

If you have questions about SAM's geothermal model, please contact [sam.support@nrel.gov](mailto:sam.support@nrel.gov).

## Plant Configuration

The plant configuration describes the plant's conversion technology and how SAM models it.

### Specify plant output

The Specify Plant Output option allows you to specify the plant's electrical capacity in kilowatts. SAM calculates the plant size required to ensure that the plant's net output meets this output requirement, with enough extra power to supply parasitic load defined by the Calculated Design values on the [Resource page](#).

### Use exact number of wells

When you choose Use Exact Number of Wells, you specify the number of wells, and SAM calculates the plant's gross capacity based on the energy available from the wells, and the plant net output by subtracting the parasitic load from the gross output. The parasitic load is defined by the Calculated Design values on the [Resource page](#).



## Conversion Plant Type

The Conversion Plant Type determines the plant's steam-to-electricity conversion efficiency, also called "brine effectiveness." The plant efficiency is different from the system efficiency, which also accounts for pumping losses from the parasitic load.

### Binary

When you choose the Binary option, you can specify the plant efficiency.

### Plant Efficiency

The steam-to-electricity conversion efficiency, expressed as a percentage of the theoretical maximum conversion efficiency.

### Flash

The Flash option allows you to choose from four subtypes that determine the plant efficiency.

For a description of the conversion system inputs see pages 12-16 of the "Revisions to GETEM Spreadsheet (Version 2009-A15)" document available at <https://energy.gov/eere/geothermal/getem-manuals-and-revision-notes>.

## System Availability

System availability losses are reductions in the system's output due to operational requirements such as maintenance down time or other situations that prevent the system from operating as designed.

**Note.** To model curtailment, or forced outages or reduction in power output required by the grid operator, use the inputs on the [Grid Limits](#) page.

To edit the system availability losses, click **Edit losses**.

The [Edit Losses](#) window allows you to define loss factors as follows:

- Constant loss is a single loss factor that applies to the system's entire output. You can use this to model an availability factor.
- Hourly losses apply to specific hours of the year.

SAM reduces the system's output in each hour by the loss percentage that you specify for that hour. For a given hour, a loss of zero would result in no adjustment. A loss of 5% would reduce the output by 5%, and a loss of -5% would increase the output value by 5%. For subhourly simulations, SAM applies the loss factor for a given hour to each time step in that hour

## Temperature Decline

The temperature decline parameters determine when and how often the project will require that new wells be drilled, and are related to the total resource potential specified on the [Resource page](#).

For a description of the temperature decline inputs, see page 9 of the "Revisions to GETEM Spreadsheet (Version 2009-A15)" document available at [http://www1.eere.energy.gov/geothermal/getem\\_manuals.html](http://www1.eere.energy.gov/geothermal/getem_manuals.html).

## Flash Technology

The two flash technology inputs impact the plant conversion efficiency for the flash conversion type.

## Pumping Parameters

The **Production Well Flow Rate** and resource temperature specified on the [Resource page](#) dictate how much energy is available to the plant for conversion into electricity. The higher the flow rate, the more steam (or hot water) moves through the system, making thermal energy available for conversion, which, in turn, means fewer wells have to be drilled and therefore a lower capital expense.

The remaining inputs impact the parasitic load for pumping. The **Injection Well Diameter** applies only when the resource type on the [Resource page](#) is EGS.

For a description of pumping, see Section 5.7 of the GETEM Technical Reference Manual (Volume I) available at [http://www1.eere.energy.gov/geothermal/getem\\_manuals.html](http://www1.eere.energy.gov/geothermal/getem_manuals.html).

For a description of EGS pumping, see Section 6.1.a of the GETEM User's Manual (Volume II), and page 4 of "Revisions to GETEM Spreadsheet (Version 2009-A15)" both available at [http://www1.eere.energy.gov/geothermal/getem\\_manuals.html](http://www1.eere.energy.gov/geothermal/getem_manuals.html).

## 13.4 Power Block

The Power Block page allows you to specify the parameters of a power block that converts thermal energy from the geothermal resource to electric energy using a conventional steam Rankine cycle power plant.

The power cycle can use either an evaporative cooling system for wet cooling, an air-cooled system for dry cooling, or a hybrid cooling system with both wet and dry cooling.

The geothermal model runs a simulation over the multi-year life of the plant (defined by **Analysis Period** on the [Financial Parameters](#) page) to account for the decline in geothermal resource. SAM models the geothermal resource decline on a monthly basis.

The two monthly power block options result in a set of twelve calculations for each year in the plant life. The hourly option results in a set of 8,760 calculations for each year. For a project with a 30-year analysis period, the monthly power block option would result in 360 sets of calculations (12 months/year × 30 years = 360 months), and the hourly power block option would result in 262,800 sets of calculations (8,760 hours/year × 30 years = 262,800 hours).

Because it is unlikely that you will have weather data available for each of the years in the analysis period, SAM uses the same weather file for each year. The only value that might change from year to year in the performance model is the resource temperature as the geothermal resource degrades over time. For the hourly simulation option, SAM only calculates the monthly geothermal temperature decline. This is done for two reasons: 1) it helps maintain comparability between the monthly and hourly options; and 2) the resource temperature does not typically change measurably on an hourly basis, but might change from month to month.

### Power Block Model

#### Model

You can choose from two different power block model options:

- The GETEM option calculates the power block's monthly output.
- The Power Block Monthly and Power Block Hourly options calculate either monthly or hourly power block output values, and use a more sophisticated algorithm based on physical principles using the

power block model developed for SAM's physical parabolic trough model. For a detailed description, see Chapter 4 of Wagner M, 2008. Simulation and Predictive Performance Modeling of Utility-Scale Central Receiver System Power Plants. Master of Science Thesis. University of Wisconsin-Madison. <http://sel.me.wisc.edu/theses/wagner08.zip>.

## Power Block Design Point

### Rated cycle conversion efficiency

The thermal to electric conversion efficiency of the power cycle under design conditions.

### Design inlet temperature (°C)

The heat transfer fluid temperature at the power cycle inlet under design conditions. SAM sets this value to the plant design temperature on the [Plant and Equipment](#) page.

### Design outlet temperature (°C)

The heat transfer fluid temperature at the power cycle outlet under design conditions.

### Boiler operating pressure (bar)

The steam pressure in the main Rankine cycle boiler at design, used to calculate the steam saturation temperature in the boiler, and thus the driving heat transfer temperature difference between the inlet heat transfer fluid and the steam in the boiler.

### Steam cycle blowdown fraction

The fraction of the steam mass flow rate in the power cycle that is extracted and replaced by fresh water. This fraction is multiplied by the steam mass flow rate in the power cycle for each hour of plant operation to determine the total required quantity of power cycle makeup water. The blowdown fraction accounts for water use related directly to replacement of the steam working fluid. The default value of 0.013 for the wet-cooled case represents makeup due to blowdown quench and steam cycle makeup during operation and startup. A value of 0.016 is appropriate for dry-cooled systems to account for additional wet-surface air cooling for critical Rankine cycle components.

## Cooling System

### Condenser type

Choose either an air-cooled condenser (dry cooling), evaporative cooling (wet cooling), or hybrid cooling system.

In hybrid cooling a wet-cooling system and dry-cooling share the heat rejection load. Although there are many possible theoretical configurations of hybrid cooling systems, SAM only allows a parallel cooling option.

### Hybrid Dispatch

For hybrid cooling, the hybrid dispatch table specifies how much of the cooling load should be handled by the wet-cooling system for each of 6 periods in the year. The periods are specified in the matrices. Each value in the table is a fraction of the design cooling load. For example, if you want 60% of heat rejection load to go to wet cooling in Period 1, type 0.6 for Period 1, and then use your mouse to select the hours and months in the schedule that Period 1 applies, and type the number 1. See the [Weekday-weekend Schedule](#) reference topic for step-by-step instructions for using assigning periods to a schedule matrix.

Directing part of the heat rejection load to the wet cooling system reduces the total condenser temperature and improves performance, but increases the water requirement.

SAM sizes the wet-cooling system to match the maximum fraction that you specify in the hybrid dispatch table, and sizes the air-cooling system to meet the full cooling load.

**Note.** The hybrid dispatch option only works with the hourly power block model. The option does not work with the monthly or GETEM power block model.

#### **Ambient temperature at design (°C)**

The ambient temperature at which the power cycle operates at its design-point-rated cycle conversion efficiency. For the air-cooled condenser option, use a dry bulb ambient temperature value. For the evaporative condenser, use the wet bulb temperature.

#### **Ref. Condenser Water dT (°C)**

For the evaporative type only. The temperature rise of the cooling water across the condenser under design conditions, used to calculate the cooling water mass flow rate at design, and the steam condensing temperature.

#### **Approach temperature (°C)**

For the evaporative type only. The temperature difference between the circulating water at the condenser inlet and the wet bulb ambient temperature, used with the ref. condenser water dT value to determine the condenser saturation temperature and thus the turbine back pressure.

#### **ITD at design point (°C)**

For the air-cooled type only. Initial temperature difference (ITD), difference between the temperature of steam at the turbine outlet (condenser inlet) and the ambient dry-bulb temperature.

#### **Condenser pressure ratio**

For the air-cooled type only. The pressure-drop ratio across the air-cooled condenser heat exchanger, used to calculate the pressure drop across the condenser and the corresponding parasitic power required to maintain the air flow rate.

#### **Min condenser pressure**

The minimum condenser pressure in inches of mercury prevents the condenser pressure from dropping below the level you specify. In a physical system, allowing the pressure to drop below a certain point can result in physical damage to the system. For evaporative (wet cooling), the default value is 1.25 inches of mercury. For air-cooled (dry cooling), the default is 2 inches of mercury. For hybrid systems, you can use the dry-cooling value of 2 inches of mercury.

#### **Cooling system part load levels**

The cooling system part load levels tells the heat rejection system model how many discrete operating points there are. A value of 2 means that the system can run at either 100% or 50% rejection. A value of three means rejection operating points of 100% 66% 33%. The part load levels determine how the heat rejection operates under part load conditions when the heat load is less than full load. The default value is 2, and recommended range is between 2 and 10. The value must be an integer.

## 13.5 System Costs

As with all of the SAM models, the cost page is used to calculate a total installed cost and an operating cost for use in the financial models. The inputs on this page do not impact the performance of the system.

### Notes.

The default cost values that appear when you create a file or case are intended to illustrate SAM's use. The cost data are meant to be realistic, but not to represent actual costs for a specific project. For more information and a list of online resources for cost data, see the technology pages on the [SAM website](#).

The System Costs page only available for cases with a cash-flow-based financial model. It is not available with the No Financial Model option or the LCOE Calculator financial model.

This is an overview of the geothermal cost inputs (which come from the GETEM model). For more details of how geothermal system costs are specified in the SAM's geothermal model, see the following sections of the GETEM documentation at the following link: <https://energy.gov/eere/geothermal/getem-manuals-and-revision-notes>.

From the GETEM Guide to Providing Input to the Model, May 2011:

#### Model Input

Pages 10-22

#### Binary

Section 4.1.c on page A-11

Section 4.1.g on page A-15

#### Flash

Section 5.2.a on page A-20

### Number of Wells to Drill

GETEM calculates the number of production wells necessary based on inputs on the [Plant and Equipment](#) page. Based on the number of production wells required, you can specify how many wells have to be drilled in this section.

Because confirmation wells can sometimes be used for production, this section has an input to specify what portion of the confirmation wells will be used on this way. The number of confirmation wells that will be used for production is calculated by multiplying the number of confirmation wells (entered in the "Drilling and Associated Costs" section) by the "% of Confirmation Wells Used for Production" and is shown in the "Number of Confirmation Wells" textbox.

The rest of the production wells have to be drilled and will incur the production well drilling cost. The number of production wells that will have to be drilled is calculated by subtracting the production wells to be drilled from the total production wells required and is shown in the "Number of Production Wells to be Drilled" textbox.

The number of injection wells is typically a function of the number of production wells. You can specify this ration in the "Ratio of Injection Wells to Production Wells" input. (Keep in mind that the ratio is the injection wells to the total number of production wells, not the number of production wells that have to be drilled.) This

value will be multiplied by the "Total Production Wells Required" value to calculate the "Number of Injection Wells to be Drilled."

## Drilling and associated costs

### Exploration and Confirmation

The cost for exploration and confirmation wells is expressed as a function of the cost of a production well. The "Cost multiplier" column is multiplied by the production well cost to calculate the "Cost per well." This value is multiplied by the "# of wells" input to calculate the "Drilling cost". You can specify other costs for exploration and confirmation in the "Non-drilling cost" column, which will be added to the "Drilling cost" to calculate the total.

### Production and Injection

Production and injection drilling costs are specified as a function of the depth of the wells. The well depth is assumed to be the resource depth, specified on the Resource input page. The drilling cost per well is calculated using the depth and the chosen cost curve, which is a function relating well depth to cost. The 3 Cost Curves (Low, Medium, and High) bracket the Sandia National Laboratories drilling data (see GETEM reference manuals for details). The cost per well for production and injection wells (derived from the depth and the cost curve) is shown in the "Cost per well" column. The number of wells shown in the "# of wells" column comes from the values in the "Number of Wells to Drill" section above. The "Drilling cost" is calculated by multiplying the "# of wells" by the "Cost per well." The total number of wells and drilling cost is displayed below the Production and Injection wells. You can specify non-drilling costs in this row, which will be added to the drilling cost, to calculate the total cost for production and injection wells.

### Surface Equipment, Installation and Stimulation Cost

Surface equipment and well stimulation costs are assumed to be a function of the total number of production and injection wells. The value entered in the "Cost per well" column will be multiplied by the value in the "# of wells" column to calculate the total, shown in the "Non-drilling cost" column.

### Over-riding calculated costs

You can choose to override drilling and associated cost calculations and enter their own cost. If the "Calculate" box is unchecked, the total for the section will be the value entered in the "Specified Total Drilling, Surface Equipment, and Stimulation Cost" input.

## Plant Capital Cost

The plant capital costs are entered on a "per Kw" basis, meaning that you enter the dollars per kilowatt, and SAM will multiply this by the size of the unit (from the "Plant and Equipment" input page) to calculate the Power Plant Cost.

The calculated value can be over-ridden by un-checking the "Calculated" checkbox and entering a value in the "Specified Plant Cost" input.

## Pump Cost Inputs

The pump costs are entered as a function of the pump depth and pump size (calculated on the Plant and Equipment input page). The installation and casing cost is specified on a per foot basis and multiplied by the calculated pump depth to determine the total cost. Pump cost is specified on a per horsepower basis and is multiplied by a function of the pump size to determine the cost per pump.

The total installed cost per pump is the sum of the pump cost and the installation and casing cost. This is multiplied by the total number of production wells required to calculate the total pump cost.

The calculated value can be over-ridden by un-checking the "Calculated" checkbox and entering a value in the "Specified Pump Cost" input.

### Recapitalization Cost

The recapitalization cost will be added each time the resource has to be re-drilled to reach a new section of the geothermal resource in order to increase the production well temperature. Recapitalization costs can be specified directly, or calculated by checking the "Calculate" checkbox. The calculated value is the sum of confirmation, production, and injection drilling costs (excluding non-drilling costs), the surface equipment and installation cost, and the total pump costs.

### Total Installed Costs

The total installed cost is the sum of all of the direct and indirect capital costs that you specify. SAM uses this value to calculate the project's [net capital cost](#), which is the total installed cost less any cash incentives on the [Incentives](#) page and plus any additional financing costs from [Financial Parameters](#) page.

#### Total installed cost (\$)

The sum of total direct cost and total indirect cost.

#### Total installed cost per capacity (\$/Wdc or \$/kW)

Total installed cost divided by the total system rated or nameplate capacity. This value is provided for reference only. SAM does not use it in cash flow calculations.

### Indirect Capital Costs

Indirect capital costs are broken down into three types: engineering, procurement, and construction; project, land, and misc; and sales tax. The first two can be entered as a percentage of direct costs, as a stand alone value, or both (which will be summed to calculate a total). The sales tax percentage is entered on the Financial Parameters page and is applied to some portion of the direct cost. These three types of indirect costs are summed to calculate the total indirect cost.

The calculated value can be over-ridden by un-checking the "Calculated" checkbox and entering a value in the "Specified Indirect Cost" input.

## 14 Solar Water Heating

The solar water heating (SWH) model represents flat-plate solar collectors with a one tank water or glycol storage system and a auxiliary electric heater. The solar water heating performance model works with either the residential or commercial [financial model](#), and assumes that the solar water heating system displaces purchases of electricity for an electric water heater. Installation and operating costs, financial assumptions, and retail electricity prices determine the value of the energy delivered by the solar water heating system.

The SWH model allows you to vary the location, hot water load profiles, mains and set temperature profiles, and characteristics of the collector, heat exchanger, and solar tanks. The model was developed at the National Renewable Energy Laboratory for SAM.

See the [SAM website](#) for additional documentation.

## Solar Water Heating Model Notes

- SAM calculates the water mains inlet temperature based on the correlation to local air temperature used in the Building America Benchmark. The algorithm is described in Burch and Christensen (2007) *Towards Development of an Algorithm for Mains Water Temperature*. SAM reports the hourly water mains temperatures on [Tables](#) on the [Results](#) page as **T mains (C)**. If you have your own mains temperature data, you can override the mains inlet temperature calculation import an 8,760 hourly mains profile on the [SWH System](#) page.
- SAM assumes that the flow rate is constant over each hour, using values from the hourly hot water draw profile that you specify. SAM calculates the flow rate in kg/hr as the draw volume converted to kg for a given hour divided by one hour.
- Collectors are assumed to be flat plate collectors plumbed in parallel, with uniform flow through each collector at the tested flow rate.
- Collectors are characterized by the linear form of the collector efficiency and IAM (incident angle modifier) equations with parameters available from test data such as those available at [www.solar-rating.org](http://www.solar-rating.org).
- The collector loop is assumed to be charged with water having  $C_p = 4.18 \text{ kJ/kg-}^\circ\text{C}$  or glycol having  $C_p = 3.4 \text{ kJ/kg-}^\circ\text{C}$ . You can specify which fluid to use.
- Collector parameters are corrected for the flow rate, heat exchanger, and pipe losses using relations in Duffie and Beckman, *Solar Engineering of Thermal Processes*, 3rd. Edition. Specifically, see p. 307 for the flow rate corrections, p. 430 for pipe-loss adjustment, and p. 427 for heat exchanger adjustment.
- The heat exchanger is external to the solar tank, has no thermal losses, and is assumed to have the constant effectiveness that you specify on the [SWH System](#) page.
- A standard differential controller controls the collector loop pump. Pump power is input and assumed totally lost.
- The energy balance differential equations are approximated with the implicit-Euler method.

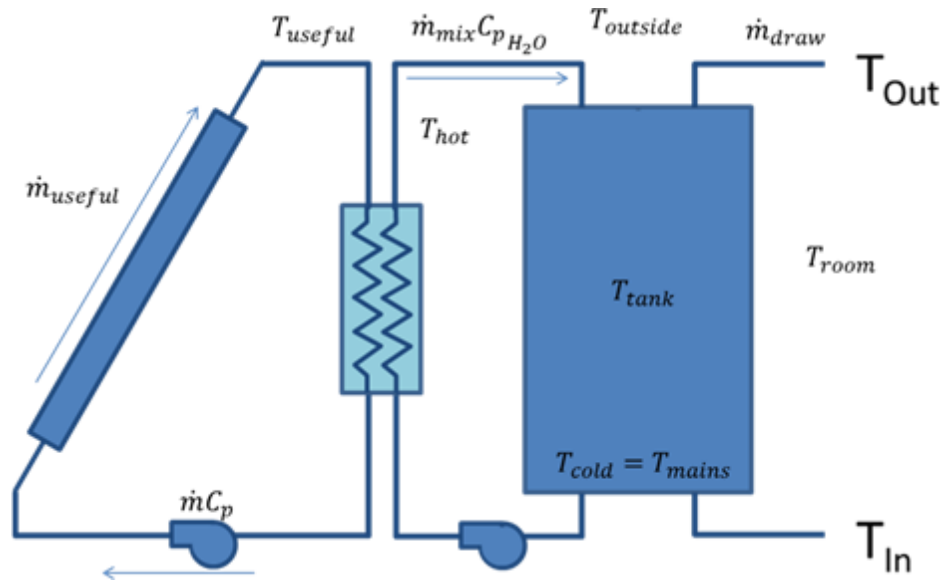
The Solar Water Heating model topics are:

- [Location and Resource](#)
- [Solar Water Heating](#)
- [System Costs](#)
- [Results](#)
- [Solar Fraction](#)

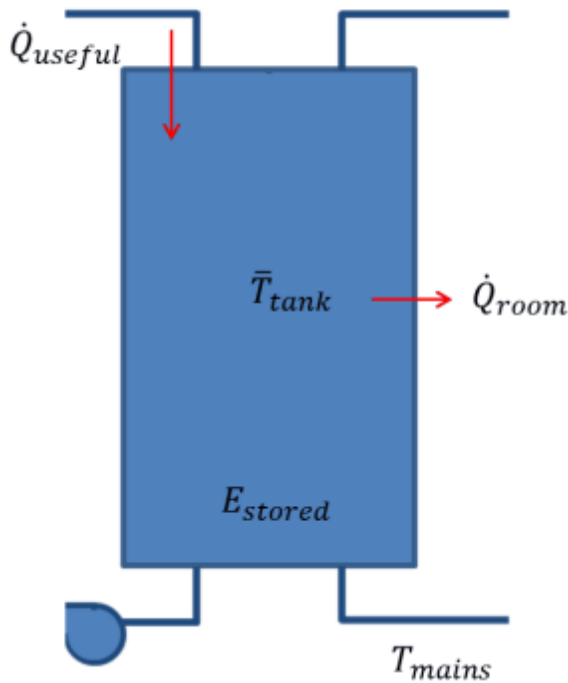
## Solar Water Heating Model Description

SAM models a closed-loop flat plate collector which transfers solar energy from the working fluid to the water in an external heat exchanger. This setup is often used in climates where freezing temperatures occur, because the collector working fluid can be different than water. Water from the solar tank is typically used to preheat water in an auxiliary water tank and reduce the amount of heat needed to bring the delivered water to the set point desired by the user. In the model used here, the solar tank is filled with water from the mains, pumped through the heat exchanger, and returned to the top of the tank.





The specific equations solved depend on whether useful solar energy is being collected or not. Below is a system diagram for when energy is being collected.



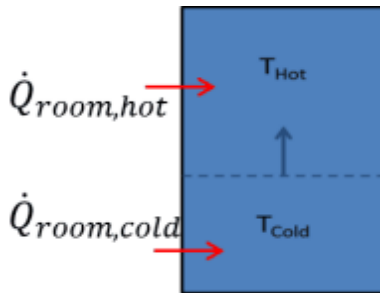
During solar collection, the tank is assumed to be fully mixed. This assumption is made because hot water continually is entering the top of the tank and mixing with cooler water underneath. A simple energy balance is performed on the tank to solve for the mean tank temperature each hour. Note that energy is added from the solar collector loop, energy is lost to the environment, mass enters the tank at the mains temperature

and exits the tank at the mean tank temperature. Making an assumption that the mass in the tank is constant results in the differential equation:

$$\frac{dT_{\text{tank}}}{dt} = \frac{\dot{Q}_{\text{useful}} - \dot{Q}_{\text{room}} + \dot{m}C_p(T_{\text{tank}} - T_{\text{mains}})}{\rho V_{\text{tank}} C_p}$$

Where the value for the useful energy delivered is derived using relations from the third edition of *Solar Engineering of Thermal Processes* by John Duffie and William Beckman.

When useful solar energy is not being collected, the tank is assumed to be stratified into one hot node and one cold node.



This stratification occurs because user draws reduce the volume of hot water in the tank, and cold water from the mains is input to replace that water. Gradually, the cold volume will increase until solar collection begins again. In the stratified discharging mode, variable volume energy balances are performed on both the hot and cold nodes. The only heat transfer modeled is transfer to the environment which is drawn in a positive sense above. The heat transfer direction is usually reversed for the hot node. The mass coming into the cold node is at the mains temperature, and no mass is assumed to leave. The variable volume nature of each node means that mass cannot be assumed constant, resulting in the following differential equation for the cold node:

$$\frac{dT_{\text{cold}}}{dt} = \frac{\dot{Q}_{\text{room,cold}} + \dot{m}C_p(T_{\text{mains}} - T_{\text{cold}})}{\rho V_{\text{cold}} C_p}$$

The mass leaving the hot node at the hot-node temperature, and no mass is assumed to enter.

$$\frac{dT_{\text{hot}}}{dt} = \frac{\dot{Q}_{\text{room,hot}}}{\rho V_{\text{hot}} C_p}$$

These three differential equations are approximated for each hour, with the express interest of determining how much energy is saved by using solar water heating.

## 14.1 Location and Resource

The Location and Resource page provides access to the solar resource library, which is a collection of weather files stored on your computer. When you first install SAM, it comes with a few default weather files in the library. As you use SAM for your own projects, you should add files to build your own library. Once files are in your library, you can use them for different projects and with different versions of SAM.

**Solar Resource Library**  
The Solar Resource library is a list of weather files that you can use for simulation, or use the tools below to add files to the library.

Search for:  Name

Name	Latitude	Longitude	Time zone	Elevation	Station ID
daggett_ca_34.865371_-116.783023_psmv3_60_tmy	34.85	-116.78	-8	561	91486
des_moines_ia_41.586835_-93.624959_psmv3_60_tmy	41.57	-93.62	-6	263	757516
faroo nd 46.9 -96.8 mts1 60 tmv	46.9	-96.8	-6	274	14914

SAM scans the following folders on your computer for valid weather files to add to the solar resource library. To use weather files stored on your computer, add folders containing the files.

C:\Users\<user>\SAM Downloaded Weather Files  
F:\little\_rock\_ar  
F:\PVGIS 5

Add/remove weather file folders...  
Refresh library

**Choose a weather file from the library.**

**List of solar resource folders.**

**Weather file for simulation.**

**Weather Data Information**  
The following information describes the weather file selected from the Solar Resource library above. This is the file

Weather file: C:\SAM\2018.10.29\solar\_resource\daggett\_ca\_34.865371\_-116.783023\_psmv3\_60\_tmy.csv

**Header Data from Weather File**

City	Station ID	Latitude
-	91486	34.85 °N
State	Data Source	Longitude
-	NSRDB	-116.78 °E
Country	Elevation	Time zone
-	561 m	GMT -8

**Annual Averages Calculated from Weather File Data**

Global horizontal	NaN kWh/m <sup>2</sup> /day	Average temperature	17.3 °C
Direct normal (beam)	7.65 kWh/m <sup>2</sup> /day	Average wind speed	2.4 m/s
Diffuse horizontal	1.27 kWh/m <sup>2</sup> /day		

\*NaN indicates missing data.

**Information from weather file header.**

**Summary data calculated from time series data.**

There are two ways to add files to your solar resource library:

### 1. Download files from the NREL National Solar Radiation Database (NSRDB)

Use the download weather file options and click **Download and add to library** to get the most up-to-date data from the NSRDB for long-term cash flow analysis, single-year analysis, and P50/P90 analysis.

### 2. Add weather file folders

If you have weather files from a source other than the NSRDB or that you've downloaded yourself directly from the NSRDB website, click **Add/remove weather file folders** to add the folder containing the files to the **Solar Data File Folders** list. SAM automatically adds any weather files it finds in these folders to the solar resource library so they will appear in the list.

When you install SAM, it creates the default download folder <user>/SAM Downloaded Weather Files folder where weather files you download from the NSRDB are stored. You can change that folder by clicking **Add/remove weather file folders** and changing the **Folder for Downloaded Solar Data Files**.

For locations not in the NSRDB, you can download weather files in the EPW format from the European Commission Photovoltaic Geographical Information System [PVGIS V5 website](#).

## See also

[Weather File Formats](#)  
[Weather Data Elements](#)  
[Typical and Single Year](#)  
[Time and Sun Position](#)  
[Folders and Libraries](#)  
[Weather Data and LK](#)

**Notes.**

You may want to model your system using weather data from several different sources and locations around your project site to understand how sensitive your analysis results are to the weather assumptions, and how much variation there is in the data from the different weather files.

You can compare results for a system using more than one weather file in a single case by using SAM's [parametric simulation](#) option.

For more information about weather data, including where to find data for locations outside of the United States, see [Weather Data](#) on the SAM website.

For a helpful discussion of weather data and power system simulation, see Sengupta, M.; Habte, A.; Gueymard, C.; Wilbert, S.; Renne, D.; Stoffel, T. (2017). "Best Practices Handbook for the Collection and Use of Solar Resource Data for Solar Energy Applications: Second Edition." NREL Report No. TP-5D00-68886. ([PDF 8.1 MB](#))

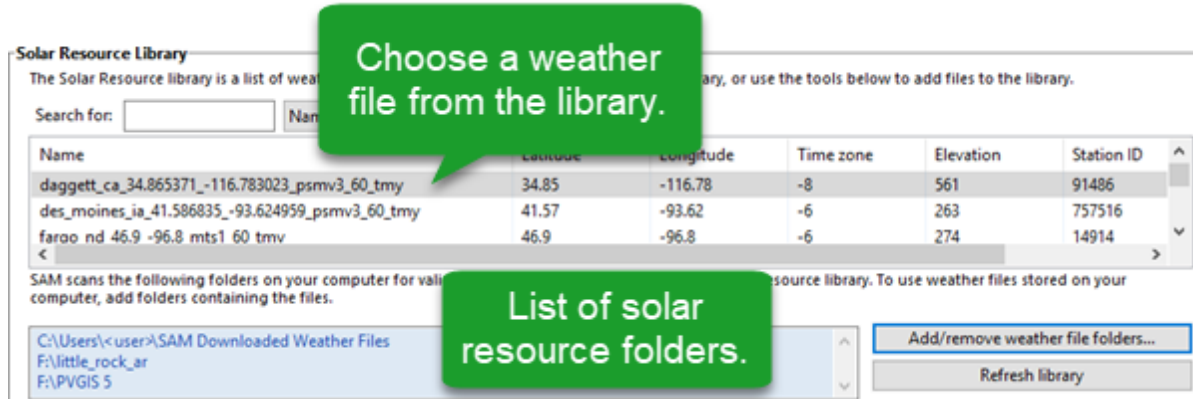
## ▼ Solar Resource Library

SAM's solar resource library displays information from weather files in your solar resource data folders. The default solar resource library that comes with SAM contains weather files for a few locations around the United States for the default configurations. As you use SAM, use **Add/remove weather file folders** to build a library of files for locations you frequently use as described in [Folders and Libraries](#).

**To choose a file from the solar resource library:**

- Click the location name in the list. You can type a few letters of the file name in the Search box to filter the list.

The full file name and information about the selected file appears under **Weather Data Information**. To see the data in the file, click **View data**.



### Add/remove weather file folders

Use the folder settings to tell SAM what folders on your computer it should scan for weather files to build the solar resource library. SAM adds any files it can identify as valid weather files in each folder you specify to the library.

Before adding a file to the library, SAM checks the data in the file displays a message if it finds any problems with the data in the file.

SAM will only add valid weather files to the library. If you add a folder that contains CSV files that are not in the SAM CSV format, it will not add those files to the library.

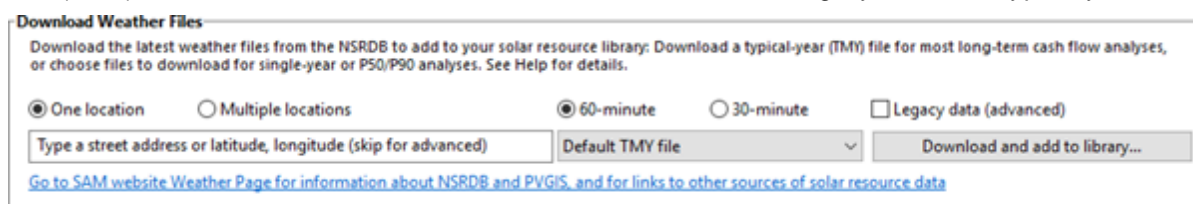
The list of solar resource folders are the folders that SAM scans for weather files to build the solar resource library.

### Refresh library

Refresh the library after adding files to the weather file folder. In most cases, SAM should automatically refresh the library as needed, but you may need to manually refresh it.

## Download Weather Files

SAM can download weather files from the latest National Solar Radiation Database (NSRDB) Physical Solar Model (PSM) datasets. For all NSRDB datasets, SAM can download single-year files or typical-year files.



**Note.** For locations not in the NSRDB, you can download EPW files from the European Commission Photovoltaic Geographical Information System [PVGIS V5 website](#) to a folder on your computer, and then use the [folder settings window](#) to add the folder to the list of folders SAM scans to build the solar resource library.

### To download a typical-year weather file for a single location:

1. Replace the text "Type a location name, street address or latitude and longitude" with a street address, city and state or country name, zip code, or latitude longitude pair. For example:

- Golden, Colorado
  - golden, co
  - 15013 Denver West Parkway, Golden CO 80401
  - 80401
  - thimpu, bhutan
2. Click **Download and add to library**.

For more instructions to download multiple files, see [Weather File Download Instructions](#) below.

SAM converts the address you type to a latitude and longitude pair for the location, and submits that information to the NSRDB along with your email address. If the location is in the region covered by the NSRDB, it returns a weather file in the SAM CSV format, and adds it to your weather file download folder. Otherwise, it displays a message telling you the location is not covered by the NSRDB.

When you first install SAM, it creates the *SAM Downloaded Weather Files* folder and assigns it as your weather file download folder. You can change the weather file download folder by clicking **Add/Remove weather file folders**. See [Folders and Libraries](#) for details.

When the download finishes, SAM displays a prompt asking you if you want to open the weather file download log. This prompt is the indication that the download finished. During the download and before that prompt appears, SAM may become unresponsive. If it does, wait for the prompt to avoid interrupting the download.

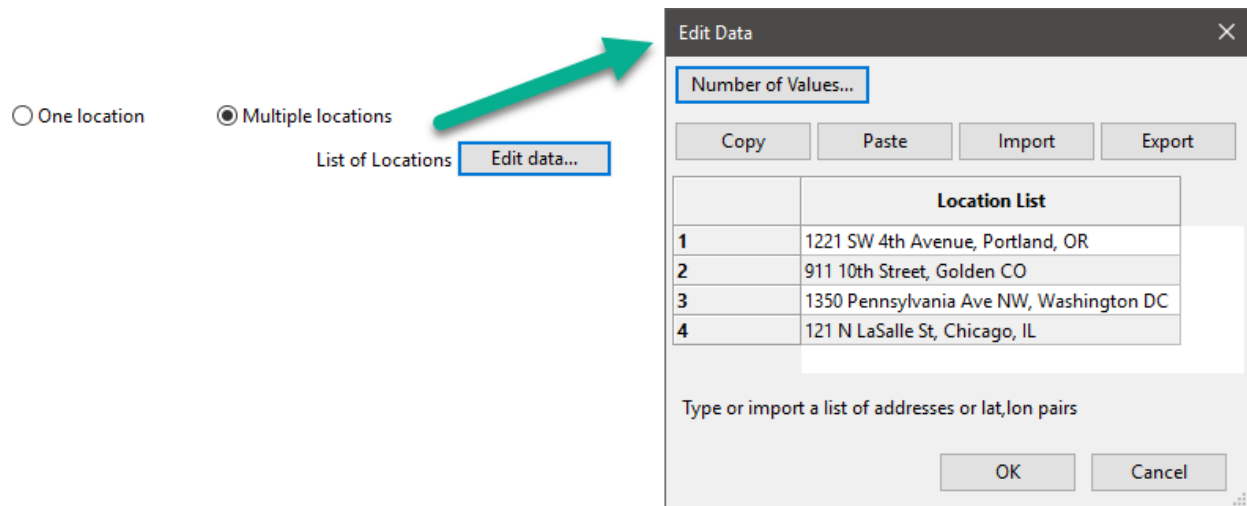
The weather file download log is a text file that SAM creates in your weather file download folder, and serves as a record of all of the files you download from the NSRDB. For each download, it lists the date and time of the request, the information you provided, the URL SAM generated, the name of the file returned by the NSRDB, or error messages it returns if the download fails. This information is useful for troubleshooting weather file download problems.

**Note.** Downloading multiple weather files from the NSRDB can take a long time. If you download files for multiple locations or years, be prepared to wait for the files to download. The download log file reports the time it takes for each file to download. Download times depend on your internet connection and computer. For a new computer with a fast connection, downloading and processing a single file takes about 10 seconds.

### One location, Multiple locations

Choose **One location** to download a weather file for a single location.

Choose **Multiple locations** to submit a list of locations and download a file or files for each location. For Multiple locations, click **Edit data** to open the Edit Data window where you can enter the list of locations and click **Number of Values** to enter the number of locations in the list.

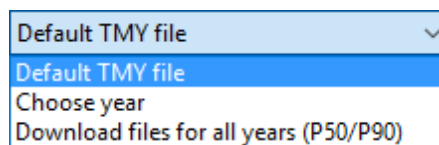


**60-minute, 30-minute**

Choose **60-minute** to download weather files with hourly time steps or 8,760 data records.

Choose **30-minute** to download files with 30-minute time steps or 17,520 data records. Thirty-minute data is not available for the NSRDB SUNY International dataset.

**Download options**



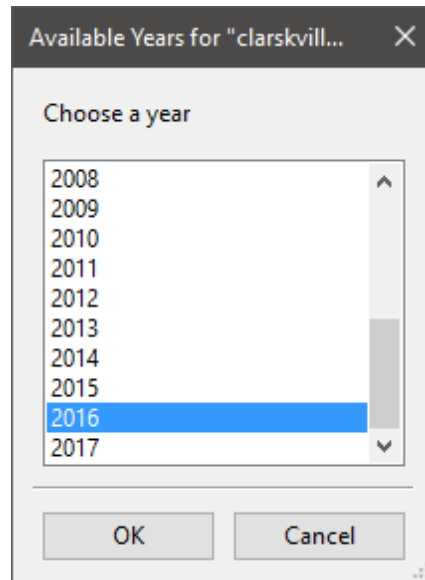
**Default TMY file**

Download a typical meteorological year weather file for the location or locations you specified.

Typical year data is appropriate when you are using simulation results for a single year to make cash flow calculations over a multi-year period.

**Choose year**

Choose a single year file to download. After you click the Download button, SAM prompts you with a list of available years for each location you requested to choose a year.



The single year option is appropriate when you want to see how the system would perform in a particular year. For example, for a residential or commercial system, if you have measured building load data for a given year, you could use weather data for the same year to see how the system's power output compares to the load.

If you use both **Choose year** and **Multiple locations**, SAM prompts you for a year for each location.

SAM queries the NSRDB to generate the list of available years. The list of available years varies between regions.

### Download files for all years (P50/P90)

Download a set of single-year files covering the range of historical data (nineteen files for 1998 through 2017 as of October 2018 for PSM data). When you click download, SAM creates a folder in your weather file download folder to store the single year files based on the location address or latitude-longitude pair you typed. It also downloads the typical meteorological year (TMY) file for the location and stores it in your weather file download folder.

SAM appends an underscore with the year to the file name so that the P50 P90 simulations work correctly. See [P50/P90 Simulations](#) for details.

If you choose to download files for all years with **Multiple locations**, SAM downloads a set of files for each location, and puts the files for each location in a separate folder. Note that this may take a long time.

## Weather File Download Instructions

### Examples of valid street address or latitude-longitude pairs:

- golden colorado
- golden, co
- 15013 Denver West Parkway, Golden CO 80401
- 80401
- 39.75, -105.15



- Super Market, F-6 Markaz, Islamabad, Pakistan
- New Delhi, India

**Note.** When the download finishes, SAM displays a prompt asking you if you want to open the weather file download log. This prompt is the indication that the download finished. During the download and before that prompt appears, SAM may become unresponsive. If it does, wait for the prompt to avoid interrupting the download.

**To download an hourly typical-year (TMY) weather file from the NSRDB (use this option for most situations):**

1. Click **One location**.
2. Type either a street address or latitude-longitude pair.
3. Click **60-minute**.
4. Choose **Default TMY File**.
5. Click **Download and add to library**.

**To download files for more than one location:**

1. Click **Multiple locations**.
2. Click **Edit data**.
3. In the Edit Data window, click **Number of Values** and type the number of locations to create a table with a row for each location.
4. Type a street address or latitude-longitude pair in the table for each location.
5. Click **OK**.
6. Choose a time step, **60-minute** for hourly, or **30-minute** for 30-minute data.
7. Choose the type of file(s) you want to download as described below.
8. Click **Download and add to library**.

## Weather Data Information

**Weather Data Information**  
The following information describes the weather file selected from the Solar Resource library above. This is the file SAM will use when you click Simulate.

Weather file:  [View data](#)

**-Header Data from Weather File-**

City	<input type="text" value="-"/>	Station ID	<input type="text" value="91486"/>	Latitude	<input type="text" value="34.85 *N"/>
State	<input type="text" value="-"/>	Data Source	<input type="text" value="NSRDB"/>	Longitude	<input type="text" value="-116.78 *E"/>
Country	<input type="text" value="-"/>	Elevation	<input type="text" value="561 m"/>	Time zone	<input type="text" value="GMT -8"/>

**-Annual Averages Calculated from Weather File Data-**

Global horizontal	<input type="text" value="NaN"/>	kWh/m <sup>2</sup> /day	Average temperature	<input type="text" value="17.3"/>	°C
Direct normal (beam)	<input type="text" value="7.65"/>	kWh/m <sup>2</sup> /day	Average wind speed	<input type="text" value="2.4"/>	m/s
Diffuse horizontal	<input type="text" value="1.27"/>	kWh/m <sup>2</sup> /day	*NaN indicates missing data.		

### Weather File

The path and name of the active weather file SAM will use for simulation. Download a different file from the NSRDB, or click a different file name in the library to change the file.

### View data

Display weather file data in the [time series data viewer](#).

**Note.** You can also see the data after running a simulation on the Results page [data tables](#) and [time series graphs](#).

### Header Data from Weather File

Header data is information in the weather file that describes the location and type of data in the file. SAM uses the time zone, elevation, latitude and longitude to calculate the sun position during simulations. It does not use the city, state, country, and other descriptive information.

### Annual Values Calculated from Weather File

When you add a weather file to the solar resource library, SAM reads weather data from the file and calculates the annual values to display for your reference. It does not use annual values during simulations.

#### Global horizontal, Direct normal (beam), Diffuse horizontal

The sum of solar irradiance data (W/m<sup>2</sup>) in the weather file converted to kW and divided by 365 days/year.

#### Average temperature

The sum of temperature data (°C) in the weather file divided by the number of records in the file (8760 for hourly data).

#### Average wind speed

The sum of wind speed data (m/s) in the weather file divided by the number of records in the file (8760 for hourly data).

### Maximum snow depth

If the weather file contains snow depth data, the maximum value of snow depth data (cm) in the weather file. NaN indicates the file does not contain snow depth data. Snow depth data is required for to model snow losses for the Detailed Photovoltaic and PVWatts models.

**Note.** For information about where to find weather files with snow depth data, see the note on the [Weather Data](#) page of the SAM website.

### Annual albedo

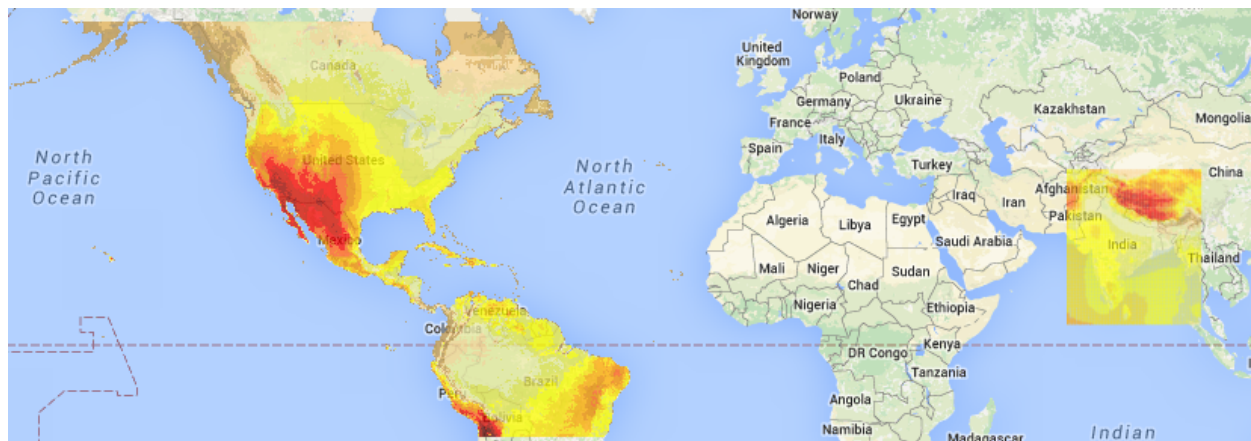
If the weather file contains albedo (ground reflectance) data, the average value of albedo values in the weather file. NaN indicates the file does not contain albedo data.

## ▼ About the NSRDB

The [NREL National Solar Radiation Database \(NSRDB\)](#) is an online database of weather files containing solar resource data in the [SAM CSV format](#). Files are available both as [typical-year](#) files and [single-year](#) files. The database covers the parts of the Americas and Asia shown in the map below. The current data is called PSM (Physical Solar Model) for the U.S., and SUNY for Asia. For details about the data see these pages on the NSRDB website:

- [U.S. data](#)
- [International data](#)

The NSRDB also contains legacy datasets for the U.S. from older versions of the NSRDB, including MTS3 (TMY3 1991-2010), MTS2 (TMY3 1991-2005), and MTS1 (TMY2 1961-1990). We recommend that you use the latest PSM data for your work in SAM, but the older data is available if you need it.



**Important Note for CSP Modelers!** SAM's CSP models assume that each DNI value in the weather file represents the average irradiance over the time step, and calculate sun angles for the midpoint of the time step. In weather files from the NSRDB, the irradiance data is measured instantaneously at either the beginning of the hour (TMY data), midpoint of the hour (single-year data), or beginning of the 30-minute time step (30-minute single-year data). As a result, if you use an NSRDB PSM weather file with a CSP model with either hourly TMY data or 30-minute single-year data, the sun angle for each time step will be for a different time than the time for the instantaneous irradiance values. See [Time Convention and Sun Position](#) for details.

**Notes.**

The NSRDB requires an email address to download weather file. When you download a weather file from SAM, SAM submits the email address that you used to [register SAM](#). NREL uses your email address to determine how many people are using the NSRDB. It does not share email addresses.

Different types of weather files in the NSRDB use different time conventions. See [Time Convention and Sun Position](#) for details.

When you download a file from the NSRDB website, SAM displays a "-" for the City, State, and Country fields because the NSRDB files do not contain that information. This will not affect simulation results. The location information SAM requires for simulations is latitude, longitude, elevation and time zone.

SAM uses the [Google Maps API Geocoding Service](#) service to identify the geographic coordinates (latitude and longitude) of a location when you type a street address or city and state name to identify the location.

For information about downloading weather files and data from other sources, see the [Weather Data](#) page on the SAM website.

SAM downloads weather files with the following hourly data from the NSRDB:

- Direct normal (beam) irradiance, DNI (W/m<sup>2</sup>)
- Diffuse horizontal irradiance, DHI (W/m<sup>2</sup>)
- Dry-bulb temperature (°C)
- Dew-point temperature (°C)
- Relative humidity (%), for single-year files only
- Atmospheric pressure (mbar)
- Wind speed at 2 meters above the ground (m/s)
- Wind direction (°E of N)
- Albedo

**Note.** Weather files with snow depth data for the Detailed Photovoltaic model are not available from the NSRDB PSM dataset. They are available for 239 locations in the United States from the legacy [MTS1 \(TMY2\) files in the original format](#), which cover the period 1961 - 1990. See [Snow Losses](#) for details.

## 14.2 Solar Water Heating

The SWH System page is where you specify the design parameters for the solar water heating system.

- For a general description of the model, see [Solar Water Heating](#).
- For a description of the model's results, see [Results](#).

## Hot Water Draw

You must specify a set of 8,760 hourly values representing the hot water system's heating load. You can either import values from a text file, or paste values from a spreadsheet or other file using your computer's clipboard.

See Specifying the Hot Water Draw for details.

### Hourly hot water draw profile (kg/hr)

The mass of hot water drawn over an hour. Click Edit Data to specify the hot water draw.

### Scale draw profile to average daily usage

Check this box to scale the 8,760 hourly data to the average value you specify in Average Daily Hot Water Usage.

### Average daily hot water usage (kg/day)

The daily average hot water usage. SAM scales the 8,760 hourly data you specify in the Edit Data window to this annual average value.

### Total annual hot water draw (kg/year)

SAM calculates the total annual hot water draw in kilograms per year by adding the 8,760 values you specify in the Edit data window, and scaling it to the average daily hot water usage value you specify.

## System

### Tilt (degrees)

The array's tilt angle in degrees from horizontal, where zero degrees is horizontal, and 90 degrees is vertical. As a rule of thumb, system designers often use the location's latitude (shown on the Location and Resource page) as the optimal array tilt angle. The actual tilt angle will vary based on project requirements.

### Azimuth (degrees)

The array's east-west orientation in degrees. An azimuth value of 180° is facing south in the northern hemisphere. As a rule of thumb, system designers often use an array azimuth of 180°, or facing the equator.

### Total system flow rate (kg/s)

The flow rate in the collector loop when it is operating.

### Working fluid

The fluid in the solar collector loop, either glycol or water.

### Number of collectors

The number of collectors in the system. SAM does not limit the number of collectors in the system.

### Diffuse sky model

The method SAM uses to estimate diffuse irradiance on the collector from data in the weather file.

**Perez** is the default option, and is suitable for most analysis. Only choose a different option if you have a reason to.

### Irradiance inputs

Determines what solar irradiance data SAM uses from the weather file.

The default option is **Beam and Diffuse**. Use one of the other options if you are using a weather file that is missing either beam or diffuse data (for those options, the weather file must also contain global horizontal irradiance data.)

### Albedo

The ground reflection coefficient. The default value is 0.2, which is appropriate for green grass.

### Total system collector area (m<sup>2</sup>)

Total area of all collectors in square meters:

$$\text{Total Collector Area} = \text{Single Collector Area} \times \text{Number of Collectors}$$

### Rated system size (kW)

The system's nominal capacity in thermal kilowatts, used to in capacity based cost and financial calculations, and to calculate the system capacity factor reported in results:

$$\text{Nameplate Capacity} = \text{Total Collector Area} \times \text{FR}_{ta} - \text{FR}_{UL} \times 30/1000$$

## Shading

External shading losses are matrices of loss values that represent reduction in incident irradiance caused by shadows from nearby objects on the array.

- Click **Edit shading** to specify [external shading losses](#).

The 3D shade calculator calculates a set of shade loss values from a three-dimensional scene, which is a drawing of the array and nearby objects.

- Click **Open 3d shade calculator** to open the [calculator](#) to draw the scene and generate shade losses.

## Curtailment and Availability

System availability losses are reductions in the system's output due to operational requirements such as maintenance down time or other situations that prevent the system from operating as designed.

**Note.** To model curtailment, or forced outages or reduction in power output required by the grid operator, use the inputs on the [Grid Limits](#) page.

To edit the system availability losses, click **Edit losses**.

The [Edit Losses](#) window allows you to define loss factors as follows:

- Constant loss is a single loss factor that applies to the system's entire output. You can use this to model an availability factor.
- Hourly losses apply to specific hours of the year.

SAM reduces the system's output in each hour by the loss percentage that you specify for that hour. For a given hour, a loss of zero would result in no adjustment. A loss of 5% would reduce the output by 5%, and a loss of -5% would increase the output value by 5%. For subhourly simulations, SAM applies the loss factor for a given hour to each time step in that hour

## Collector

The Collector inputs describe the collector's physical characteristics. You can either choose a set of collector parameters from a library, or enter your own.

### Enter user defined parameters

Choose this option to specify your own collector parameters.

### Choose from library

Use this option to choose a collector from the collector library. SAM applies parameters from the library to model the collector. The parameter values are listed in the Library table.

The collector library contains parameters for collectors certified by the [Solar Rating and Certification Corporation \(SRCC\)](#).

## Collector Parameters

### SRCC# (library only)

The collector's SRCC number. SAM does not use this value.

### Type (library only)

A description of the type of collector. SAM does not use this value.

### Collector area

The area of a single collector. Choose a value consistent with the area convention used in the collector efficiency equation. For example, use gross area for all SRCC data.

### FR<sub>ta</sub>

Optical gain  $a$  in Hottel-Whillier-Bliss (HWB) equation,  $h_{coll} = a - b \times dT$ .

### FR<sub>UL</sub> (W/m<sup>2</sup>-°C)

Thermal loss coefficient  $b$  in the Hottel-Whillier-Bliss (HWB) equation,  $h_{coll} = a - b \times dT$ .

### Incidence angle modifier (IAM)

The incident angle modifier coefficient: The constant  $b_0$  in the equation,  $IAM = 1 - b_0 \times (1/\cos(q) - 1)$ .

### Test fluid

The solar system's heat transfer fluid.

### Test flow rate

Fluid flow rate used to generate test data.

## Solar Tank and Heat Exchanger

### Solar tank volume (m<sup>3</sup>)

The actual volume of the solar storage tank. Note that the actual volume may be different from the rated volume.

### Solar tank height to diameter ratio

Defines the solar storage tank geometry, and by extension its geometry.

### Solar tank heat loss coefficient (U value) (W/m<sup>2</sup>.C)

The solar storage tank loss coefficient. Note that  $1 \text{ kJ/h-m}^2\text{-}^\circ\text{C} = 3.6 \text{ W/m}^2\text{-}^\circ\text{C}$ .

**Solar tank maximum water temperature (C)**

The maximum allowable temperature of the water in the tank in degrees Celsius. If the calculated temperature exceeds the maximum value, SAM sets the tank temperature to the maximum value. This is a simple representation of the opening of a relief valve, based on the bulk tank temperature rather than the temperature at the inlet or outlet node.

**Heat exchanger effectiveness**

Heat exchanger effectiveness, where the effectiveness  $e$ , is defined as  $e = (T_{cold-out} - T_{cold-in}) / (T_{hot-in} - T_{cold-in})$ .

**Outlet set temperature (C)**

The desired set temperature delivered to the user. The value in this box is used only if **Use custom set temperatures** is not checked.

**Mechanical room temperature (C)**

The temperature where the solar tank is stored. This temperature is used to compute heat transfer to and from the storage tank as:

$$Q_{loss} = UA_{tank}(T_{room} - T_{tank})$$

**Piping and Pumping**

The Piping and Pumping inputs are used to calculate parasitic power requirements to pump water through the system.

**Total piping length in system (m)**

Estimate of piping in system to compute pipe losses. For studies where piping loss is not of interest, reduce this length to small value, such as 0.001 m.

**Pipe diameter (m)**

Average diameter of system piping

**Pipe insulation conductivity (W/m.C)**

Thermal conductivity of pipe insulation in W/m-°C

**Pipe insulation thickness (m)**

Average thickness of insulation

**Pump power (W)**

The electric pump's peak power rating in Watts.

**Pump efficiency (0 to 1)**

An estimate of the electric pump's efficiency.

**Custom Water Input****Use custom mains profile**

By default, SAM calculates mains temperature data from the ambient temperature data in the weather file.

Check this box to provide mains temperature data instead of using SAM's calculated values.



### Input annual or monthly values

Choose this option if you have a single mains temperature value to apply to all hours of the year. Click **Edit values** for **Annual or monthly mains profile**, and in the Edit Values window either type a single value and click **Apply**, or type a value for each month of the year.

SAM applies the value you type to each time step of the simulation, so the annual or monthly mains temperature you type should be an annual average value or a set of monthly average values.

### Input hourly mains profile

Choose this option if you have time series mains temperature data. For hourly simulations, provide a set of 8,760 values. Click **Edit data** for **Hourly custom mains profile** to import the time series data or paste it from your computer's clipboard.

### Use custom set temperatures

Check this box and click **Edit data** for **Hourly custom set temperatures** if you want to specify custom hourly or monthly values for the outlet set temperature, and click Edit data .

If the box is not checked, SAM uses the **Outlet set temperature** value for every hour of the year.

## Specifying the Hot Water Draw

The hot water draw represents the solar water heating system's hourly thermal load over the period of one year.

A load data file is a text file with 8,761 rows: The first row is a text header that SAM ignores, and the remaining 8,760 rows must contain average hourly hot water demand data in kg/hr. The first data element represents the hour beginning at midnight and ending at 1 a.m. on January 1 when you run the model with a weather file in one of SAM's standard formats, TMY2, TMY3, or EPW.

### To import load data from a properly formatted text file:

1. On the SWH System page, click **Edit data**.
2. In the Edit Hourly Data window, click **Import**.
3. Navigate to the folder containing the load data file and open the file.  
SAM displays the data in the data table. Use the scroll bars to see all of the data.
4. Click **OK** to return to the SWH System page.

### To import load data from a spreadsheet or other file:

1. On the SWH System page, click **Edit**.
2. Open the spreadsheet containing the load data. The data must be in a single column of 8,760 rows, and expressed in kg.
3. In the spreadsheet, select the load data and copy it.
4. In the Edit Hourly Data window, click **Paste**.
5. You can also copy data from the Edit Hourly Data window by clicking **Copy**, or export the data to a text file by clicking **Save**.

If you do not have a complete 8,760 set of load data, you can use a set of daily load profiles for each month, and use SAM to create a set of 8,760 values.

**To create a load data set using daily load profiles:**

1. On the SWH System page, click **Edit data**.
2. In the Edit Hourly Data window, check **Use monthly grid to generate 8760 data**.
3. For each month of the year, define a daily load profile by typing a kg hot water draw value for each of the 24 hours of the day. The first column represents the first hour of the day, beginning at midnight and ending at 1:00 a.m.  

If you want to specify separate load profiles for weekdays and weekends, click Weekend Values to define profiles that apply to two days each week. SAM arbitrarily assumes that the first day in the data set is a Monday, and that weekends fall on Saturday and Sunday.

If you do not specify separate weekend profiles, SAM applies the weekday profile to all days of the week.
4. When you have specified all of the daily load profiles, click **To 8760** to transfer the data to the User Specified data table. You must complete this step for SAM to use the profile data in the simulation.  

When you define a load with daily load profiles, SAM assumes that all days in a given month have identical load profiles.
5. If you want to export the 8,760 data to a text file, click **Save**. You can also copy the data to a spreadsheet or other file by clicking **Copy**, and then pasting the data in to the file.

## 14.3 System Costs

SAM uses the variables on the SWH System Costs page to calculate the project investment cost and annual operating costs reported in the project [cash flow](#) and used to calculate cost metrics.

Variable values in boxes with white backgrounds are values that you can edit. Boxes with blue backgrounds contain calculated values or values from other pages that SAM displays for your information.

The SWH System Costs page is divided into four main categories. The first two, Direct Capital Costs and Indirect Capital Costs, are summed in the third category, Total Installed Costs. Because only the Total Installed Cost value affects the cash flow calculations, you can assign capital costs to the different cost categories in whatever way makes sense for your analysis. For example, you could assign the cost of designing the collector to the collector cost category or to the engineer-procure-construct category with equivalent results. The categories are provided to help you keep track of the different costs, but do not affect the economic calculations. After assigning costs to the categories, verify that the total installed costs value is what you expect. The fourth category of costs covers Operation and Maintenance.

**Notes.**

The default cost values that appear when you create a file or case are intended to illustrate SAM's use. The cost data are meant to be realistic, but not to represent actual costs for a specific project. For more information and a list of online resources for cost data, see the technology pages on the [SAM website](#).

The System Costs page only available for cases with a cash-flow-based financial model. It is not available with the No Financial Model option or the LCOE Calculator financial model.

## Direct Capital Costs

A direct capital cost represents an expense for a specific piece of equipment or installation service that applies in year zero of the cash flow.

**Note:** Because SAM uses only the total installed cost value in cash flow calculations, how you distribute costs among the different direct capital cost categories does not affect the final results.

### Collector cost (\$/m<sup>2</sup>, \$/Unit, or \$/W)

The cost of collectors in the system. You can either include labor costs for collector installation in the collector cost, or account for it separately using the installation cost category. The total collector cost is calculated as either:

- Dollars per square meter multiplied by collector area on the [SWH System page](#), or
- Dollars per unit, representing the total collector cost, or
- Dollars per thermal watt of collector capacity multiplied by the nameplate capacity on the [SWH System page](#).

### Storage cost (\$/m<sup>3</sup> or \$/Unit)

The cost of the solar storage tanks. The total storage cost is either:

- Dollars per cubic meters multiplied by the storage volume on the [SWH System page](#), or
- Dollars per unit, representing the total storage cost.

### Balance of system (\$)

A fixed cost that can be used to account for costs not included in the collector and storage cost categories, for example, the mounting racks and piping.

### Installation cost (\$)

A fixed cost that can be used to account for labor or other costs not included in the other cost categories.

### Contingency (%)

A percentage of the sum of the collector, storage, balance of system, and installation costs to account for expected uncertainties in direct cost estimates.

### Total direct cost (\$)

The sum of collector, storage, balance of system, installation, and contingency costs.

## Indirect Capital Costs

An indirect cost is typically one that cannot be identified with a specific piece of equipment or installation service.

**Note:** Because SAM uses only the total installed cost value in cash flow calculations, how you distribute costs among the different indirect capital cost categories does not affect the final results.

**Engineer, Procure, Construct (% and \$)**

Engineer-procure-construct costs, sometimes abbreviated as EPC costs, are costs associated with the design and construction of the project, which SAM calculates as the sum of a "non-fixed cost" and a fixed cost.

**% of Direct Cost** is a value that you type as a percentage of **Total Direct Cost** (under **Direct Capital Cost**).

**Non-fixed Cost** is the product of **% of Direct Cost** and **Total Direct Cost**.

**Fixed Cost** is a value that you type as a fixed amount in dollars.

The total engineer-procure-construct cost is the sum of **Non-fixed Cost** and **Fixed Cost**.

**Project, Land, Maintenance (% and \$)**

Costs associated with land purchases, permitting, and other costs which SAM calculates as the sum of a "non-fixed cost" and a fixed cost.

SAM does not use the land area value shown on the solar field page for trough and tower systems in the land cost calculation.

**% of Direct Cost** is a value that you type as a percentage of **Total Direct Cost** (under **Direct Capital Cost**).

**Non-fixed Cost** is the product of **% of Direct Cost** and **Total Direct Cost**.

**Fixed Cost** is a value that you type as a fixed amount in dollars.

The total project-land-miscellaneous cost is the sum of **Non-fixed Cost** and **Fixed Cost**.

**Sales tax (%)****Sales tax basis, %**

The percentage of total direct cost used to calculate sales tax amount.

SAM calculates the total sales tax amount by multiplying the sales tax rate from the [Financial Parameters](#) page by the sales tax basis on the System Costs page:

$$\text{Total Sales Tax (\$)} = \text{Sales Tax Rate (\%)} \times \text{Sales Tax Basis (\%)} \times \text{Total Direct Cost (\$)}$$

For an explanation of the effect of sales tax on income tax, see **Sales Tax** on the [Financial Parameters](#) topic for the financial model you are using (Residential, Commercial, Single Owner, etc.)

**Total indirect cost ( \$ )**

The sum of engineer-procure-construct costs, project-land-miscellaneous costs, and sales tax.

**Total Installed Cost**

The total installed cost is the sum of all of the direct and indirect capital costs that you specify. SAM uses this value to calculate the project's [net capital cost](#), which is the total installed cost less any cash incentives on the [Incentives](#) page and plus any additional financing costs from [Financial Parameters](#) page.

**Total installed cost ( \$ )**

The sum of total direct cost and total indirect cost.

**Total installed cost per capacity (\$/Wdc or \$/kW)**

Total installed cost divided by the total system rated or nameplate capacity. This value is provided for reference only. SAM does not use it in cash flow calculations.

## Operation and Maintenance Costs

Operation and Maintenance (O&M) costs represent annual expenditures on equipment and services that occur after the system is installed. SAM allows you to enter O&M costs in three ways: Fixed annual, fixed by capacity, and variable by generation. O&M costs are reported on the project [cash flow](#) in Years 1 and later..

For each O&M cost category, you can specify an optional annual **Escalation Rate** to represent an expected annual increase in O&M cost above the annual inflation rate specified on the [Financial Parameters](#) page. For an escalation rate of zero, the O&M cost in years two and later is the year one cost adjusted for inflation. For a non-zero escalation rate, the O&M cost in years two and later is the year one cost adjusted for inflation plus escalation.

For expenses such as component replacements that occur in particular years, you can use an annual schedule to assign costs to individual years. See below for details.

### Fixed annual cost (\$/yr)

A fixed annual cost that applied to each year in the project cash flow.

### Fixed cost by capacity (\$/kW-yr)

A fixed annual cost proportional to the system's rated or nameplate capacity.

### Variable cost by generation (\$/MWh)

A variable annual cost proportional to the system's total annual electrical output in AC megawatt-hours. The annual energy output depends on either the performance model's calculated first year value and the **degradation rate** from the [Lifetime](#) page, or on an annual schedule of costs, depending on the option chosen.

For systems with include battery storage:

### Battery replacement cost

The battery replacement cost in Year 1 dollars per kWh of installed battery capacity. SAM uses the inflation rate from the [Financial Parameters](#) page to calculate the replacement cost in the replacement year.

**Note.** To include battery replacements costs in your analysis, be sure to choose a battery replacement option on the [Battery Storage](#) page.

## Entering Periodic Costs

SAM allows you to specify any of the four operation and maintenance (O&M) cost categories on the System Costs page either as a single annual cost, or using a table of values to specify an annual schedule of costs. An annual schedule makes it possible to assign costs to particular years in the analysis period. Annual schedules can be used to account for component replacement costs and other periodic costs that do not recur on a regular annual basis.

You choose whether to specify an O&M cost as a single annual value or an annual schedule with the grey and blue button next to each variable. SAM uses the option indicated by the blue highlight on the button: A blue highlighted "Value" indicates a single, regularly occurring annual value. A blue highlighted "Sched" indicates that the value is specified as an annual schedule.

For example, to account for component replacement costs, you can specify the fixed annual cost category as an annual schedule, and assign the cost of replacing or rebuilding the component to particular years. For a 30-year project using a component with a seven-year life, you would assign a replacement cost to years

seven, 14, and 21. Or, to account for expected improvements in the component's reliability in the future, you could assign component replacement costs in years seven, 17, and 27. After running a simulation, you can see the replacement costs in the project [cash flow](#) in the appropriate column under Operating Expenses. SAM accounts for the operating costs in the other economic metrics including the levelized cost of energy and net present value (NPV).

#### Notes.

If you use the annual schedule option to specify equipment replacement costs, SAM does not calculate any residual or salvage value of system components based on the annual schedule. SAM calculates salvage value separately, using the salvage value you specify on the [Financial Parameters](#) page.

Dollar values in the annual schedule are in nominal or current dollars. SAM does not apply inflation and escalation rates to values in annual schedules.

The following procedure describes how to define the fixed annual cost category as an annual schedule. You can use the same procedure for any of the other operation and maintenance cost categories.

#### To assign component replacement costs to particular years:

1. In the Fixed Annual Cost category, note that the "Value" label of the grey and blue button is blue indicating that the single value mode is active for the variable.

Fixed Annual Cost   \$/yr

In this case, SAM would assign an annual cost of \$284 to each year in the project cash flow.

2. Click the button so that "Sched" label is highlighted in blue. SAM replaces the variable's value with an Edit button.

Edit...

3. Click **Edit** to open the [Edit Schedule](#) window.
4. In the Edit Schedule window, use the vertical scroll bar to find the year of the first replacement, and type the replacement cost in current or constant dollars for that year.  
To delete a value, select it and press the Delete key on your keyboard.

**Note.** You must type a value for each year. If you delete a value, SAM will clear the cell, and you must type a number in the cell or SAM will consider the schedule to be invalid. Type a zero for years with no annual costs.

5. When you have finished editing the schedule, click **Accept**.

Because you must specify an O&M cost category as either an annual cost or annual schedule, to assign both a recurring annual fixed cost and periodic replacement cost, you must type the recurring cost in each year of the annual schedule, and for years with replacement costs, type the sum of the recurring and replacement costs.

## 14.4 Results

After running a simulation, SAM displays hourly results for the solar water heating model on the Results page [Tables](#) and [Time Series](#) graphs.

**Note.** Power units (W, kW) are average values over the simulation time step.

Variable Name	Units	Description
Energy saved	W	Energy saved by the solar water system.
Hot water draw	kg/hr	The hourly usage of hot water specified in the draw profile on the input page.
Irradiance - Beam	W/m <sup>2</sup>	Direct normal irradiance value from the weather file.
Irradiance - Diffuse	W/m <sup>2</sup>	Diffuse horizontal irradiance value from the weather file.
Irradiance - Incident	W/m <sup>2</sup>	The total hourly incident global irradiance incident on the collector.
Irradiance - Transmitted	W/m <sup>2</sup>	The total hourly radiation that makes it into the collector. Depends on the optical properties of the collector.
Operation mode		<p>1 - startup mode, useful energy is collected and tank temperature is somewhat stratified.</p> <p>2 - mixed mode, useful energy is collected and tank temperature is fairly uniform.</p> <p>3 - stratified mode, no useful energy is collected and tank temperature is very stratified.</p>
P pump	W	Electric pump power required to drive the collector loop and heat exchanger loop.
Power generated by the system	kW	Equivalent to the energy saved by the system, expressed in kW. When you run the solar water heating model with a financial model, this is the value used by the financial model.
Q auxiliary	W	Electric power required by the auxiliary heater to raise the water temperature from the solar storage tank to the set temperature: $Q_{aux} = \dot{m}_{draw} C_p (T_{set} - T_{deliv})$ , where $T_{deliv}$ is the temperature of the water delivered from the solar tank. Because solar heat has been added to the water, $T_{deliv} > T_{mains}$ , and less power is needed to bring the water to the desired set temperature than would be required without the solar water heating system.
Q auxiliary only	W	Electric power that would be required without the solar water heating system:

$$Q_{aux,only} = \dot{m}_{draw} C_p (T_{set} - T_{mains}),$$

Q delivered	W	Thermal power delivered by the solar water heating system at the solar storage tank outlet: $Q_{delivered} = \dot{m}_{draw} C_p (T_{deliv} - T_{mains})$
Q loss	W	Envelope loss to room: $Q_{loss} = UA_t (T_{tank} - T_{room})$ .
Q saved	W	Electric energy saved by the solar water heating system: $Q_{saved} = Q_{aux,only} - Q_{aux} - P_{pump}$ . This value is equivalent to the energy delivered by the solar water heating system.
Q transmitted	W	Solar irradiance transmitted through the collector glass, accounting for collector area: $Q_{transmitted} = I_{transmitted} * A_c$ , where $I_{transmitted}$ is the transmitted irradiance and $A_c$ is the total collector area.
Q useful	W	Power delivered to the water tank, equal to the power received by the collector minus losses from the collector to the surroundings: $\dot{Q}_{useful} = \dot{m} C_p [T_{f,o} - T_{f,i}]$
Shading losses	%	Percent loss of incident beam irradiance due to shading, determined by the shading factors that you specify on the Solar Water Heating page.
T ambient	°C	The mid-hour ambient temperature calculated by averaging the end-of-hour temperature from the previous hour with the end-of-hour temperature from the current hour in the weather file.
T cold	°C	The temperature of the cold portion of the solar storage tank volume in stratified mode. If the tank is not stratified, this value is equal to the previous hour's cold temperature.
T delivered	°C	The temperature of the water delivered from the storage tank.
T hot	°C	The temperature of the hot portion of the solar storage tank volume in stratified mode. If not stratified, this value is equal to the previous hour's hot temperature.
T mains	°C	The temperature of water incoming from the supply source.
T tank	°C	The mean temperature of the solar storage tank.
V cold	m <sup>3</sup>	The estimated volume of the cold portion of the solar storage tank, where "cold" is with respect to the hot portion of the tank. SAM models the hot and cold

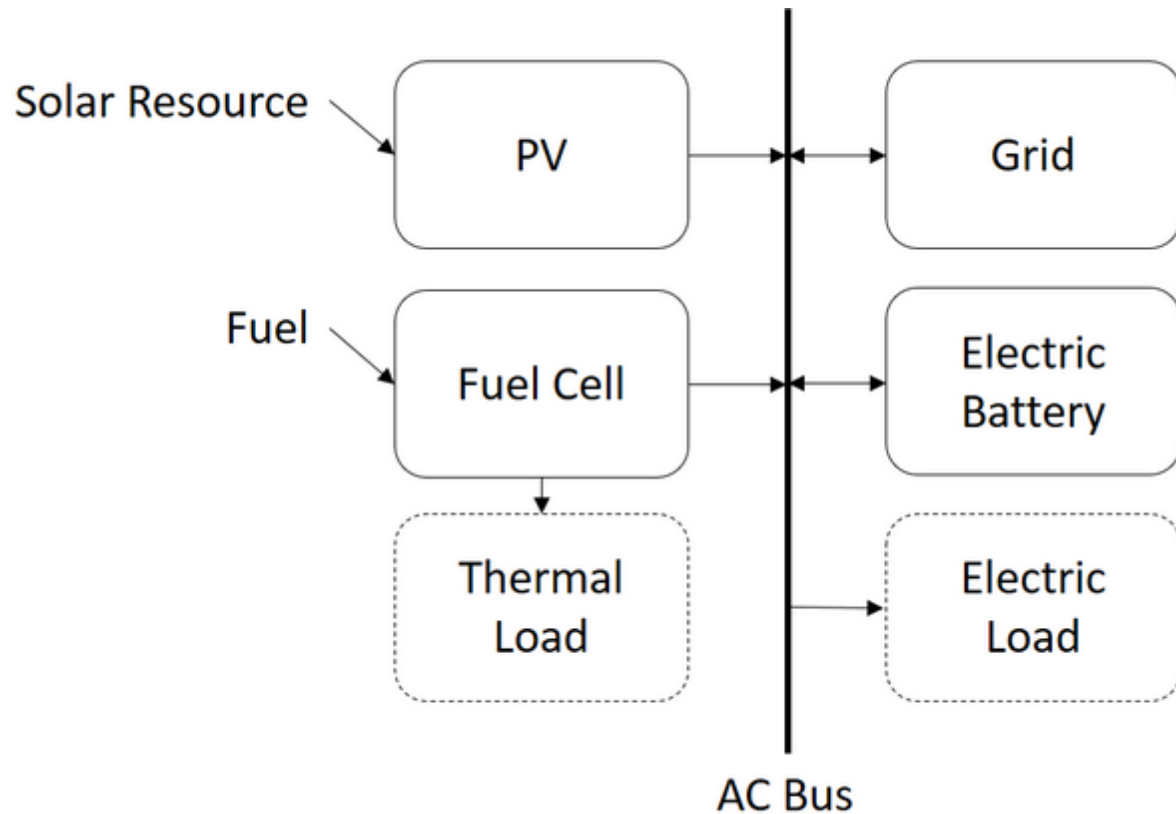


		portions as separate nodes. The cold volume increases as users draw water from the tank and mains water replaces it.
V hot	m <sup>3</sup>	The estimated volume of the hot portion of the solar storage tank, where "hot" is with respect to the cold portion of the tank. SAM models the hot and cold portions as separate nodes. The hot volume increases from hour to hour as the useful energy from the collector is added until the hot volume is equal to the tank volume (and cold volume is zero).

## 15 Fuel Cell

SAM's Fuel Cell model is based on the [Fuel Cell Power Model](#) initially released in 2012 and designed to model molten carbonate, phosphoric acid, and solid oxide fuel cells for "tri-generation" systems that provide heat and electricity to a commercial building or facility and hydrogen for vehicles or for storage to generate electricity. The Fuel Cell Power model was originally implemented in Microsoft Excel workbooks with one workbook for each of the three types of fuel cell. These workbooks and their documentation are available for download from the Fuel Cell Power Model website linked above.

The model is implemented in SAM as the Fuel Cell performance model, available with either the Commercial or PPA Single Owner [financial model](#). The fuel cell converts natural gas, hydrogen, or another fuel into electricity and heat. The commercial model is for a commercial building or facility that uses electricity and heat from the system to reduce energy costs for the commercial operation. The PPA single owner model is for a revenue-generating power generation project.



The fuel cell performance model uses the following input pages to describe the components of a grid-connected tri-generation system:

- [Fuel cell](#) model that converts a fuel into electricity, heat, and hydrogen.
- [PVWatts](#) for a photovoltaic (PV) system.
- Optional [battery storage](#) model for an electric storage system.
- A [dispatch](#) model to determine how to operate the combined system.

When you combine the fuel cell model with the Commercial financial model, you must also provide information about the electricity and thermal loads and retail rates for electricity and heat: retail electricity and heat costs:

- An [electric load](#) hourly or subhourly profile.
- A [thermal load](#) (heat) hourly or subhourly profile.
- [Electricity rates](#) are retail rates for fixed, energy, and demand charges with optional time-of-use and tiered rates.
- [Thermal rates](#) are flat retail rates for heat purchases and sales.

For the PPA single owner model with battery storage, there is no electric or thermal load because the system is not for a commercial building or facility, but you can specify retail rates to account for the cost of electricity to charge the battery.

## 15.1 PV System

The PV System page is where you define the parameters of the photovoltaic system, which includes the photovoltaic array and inverter. The fuel cell model uses an implementation of PVWatts to represent the photovoltaic system.

The inputs on the System Design page describe the physical characteristics of the photovoltaic system. You only need to provide basic information about the system. PVWatts makes assumptions about modules, inverter, and other parts of the system so you do not need to provide detailed information about those parts of the system.

**Note.** SAM uses PVWatts Version 7, which is different from the online [PVWatts® Calculator](#). SAM's results will likely be different from the online calculator's results until the online calculator is updated. See [About PVWatts Versions](#) for more information.

### System Parameters

The system inputs define the size of the system, [losses](#), and the array orientation.

#### System nameplate capacity, kWdc

The DC system capacity is the DC (direct current) power rating of the photovoltaic array in kilowatts (kW) at standard test conditions (STC). PVWatts can model any size of array, from residential rooftop systems to large ground-mounted power generation systems.

#### Module type

The type of modules in the system. If you do not have information about the modules in the system, use the default standard module type.

Module Type	Approximate Nominal Efficiency	Module Cover	Temperature Coefficient of Power	Fill Factor (for self-shading)
Standard (crystalline Silicon)	17%	Glass	-0.47 %/°C	77.1%
Premium (crystalline Silicon)	20.1	Anti-reflective	-0.35 %/°C	80.1%
Thin film	15.6	Glass	-0.20 %/°C	70.6%

PVWatts uses a basic set of equations to represent the module's physical properties and performance. The module type determines how PVWatts calculates the angle-of-incidence correction factor as sunlight passes through the module cover to the photovoltaic cell, and the cell's operating temperature.

#### DC to AC ratio

The DC to AC size ratio is the ratio of the inverter's AC rated size to the array's DC rated size. Increasing the ratio increases the system's output over the year, but also increases the array's cost. The default value is 1.10, which means that a 4 kW system size would be for an array with a 4 DC kW nameplate size at standard test conditions (STC) and an inverter with a 3.63 AC kW nameplate size.

For a system with a high DC to AC size ratio, during times when the array's DC power output exceeds the inverter's rated DC input size, the inverter limits the array's power output by increasing the DC

operating voltage, which moves the array's operating point down its current-voltage (I-V) curve. PVWatts models this effect by limiting the inverter's power output to its rated AC size.

The default value of 1.10 is reasonable for most systems. A typical range is 1.10 to 1.25, although some large-scale systems have ratios of as high as 1.50. The optimal value depends on the system's location, array orientation, and module cost.

### Inverter efficiency

The inverter's nominal rated DC-to-AC conversion efficiency, defined as the inverter's rated AC power in kilowatts divided by its rated DC power in kilowatts expressed as a percentage. The default value is 96%.

PVWatts calculates the inverter's hourly operating efficiency based on the nominal efficiency and an efficiency curve.

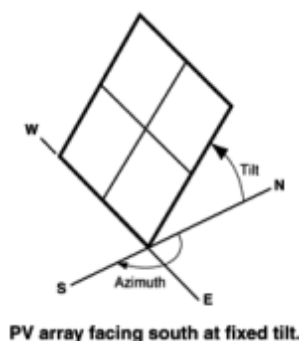
## Orientation

### Array type

The array type describes whether the PV modules in the array are fixed, or whether they move to track the movement of the sun across the sky with one or two axes of rotation. The default value is for a fixed array with no tracking.

### Fixed open rack and roof mount

The array is fixed at the tilt and azimuth angles defined by the values of **Tilt** and **Azimuth** and does not follow the sun's movement.



For systems with fixed arrays, you can choose between an open rack or a roof mount.

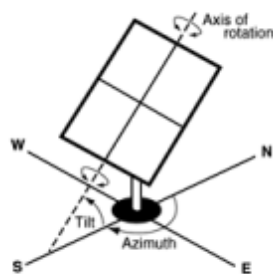
**Fixed open rack** is appropriate for ground-mounted systems. The open rack option assumes that air flows freely around the array, helping to cool the modules and reduce cell operating temperatures. (The array's output increases as the cell temperature decreases for at a given incident solar irradiance.) The open rack option also assumes that modules are arranged in rows and uses the ground coverage ratio (GCR) to estimate irradiance losses due to self shading caused when modules in neighboring rows cause shadows on the array.

**Fixed roof mount** is typical of residential installations where modules are attached to the roof surface with standoffs that providing limited air flow between the module back and roof surface (typically between two and six inches). The roof mount option assumes that there is no self shading between modules.

### 1-axis tracking and 1-axis backtracking

The array is fixed at the angle from the horizontal defined by the value of **Tilt** and rotates about the tilted

axis from east in the morning to west in the evening to track the daily movement of the sun across the sky. **Azimuth** determines the array's orientation with respect to a line perpendicular to the equator.



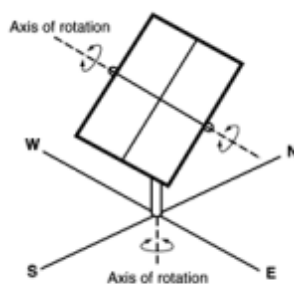
One axis tracking PV array with axis oriented south.

For **1-axis tracking**, PVWatts models self shading based on the ground coverage ratio (GCR).

For **1-axis backtracking**, PVWatts assumes that there is no self shading because the trackers rotate modules to avoid it. Backtracking is a tracking algorithm that rotates the array toward the horizontal during early morning and late evening hours to reduce the effect of self shading. The one-axis tracking algorithm assumes a rotation limit of  $\pm 45$  degrees from the horizontal.

## 2-axis tracking

The array rotates from east in the morning to west in the evening to track the daily movement of the sun across the sky, and north-south to track the sun's seasonal movement throughout the year. For two-axis tracking, SAM ignores the values of **Tilt** and **Azimuth**.



Two-axis tracking PV array

PVWatts does not model self shading for 2-axis tracking. You can adjust the [Losses](#) to account for those losses.

### Tilt, degrees

The array's tilt angle in degrees from horizontal, where zero degrees is horizontal, and 90 degrees is vertical and facing the equator (in both the southern and northern hemispheres).

As a rule of thumb, system designers sometimes use the location's latitude (shown on the [Location and Resource](#) page) as the optimal array tilt angle. The actual tilt angle will vary based on project requirements.

### Azimuth, degrees

The array's east-west orientation in degrees. An azimuth value of zero is facing north, 90 degrees = east, 180 degrees = south, and 270 degrees = west, regardless of whether the array is in the northern or southern hemisphere.

For systems north of the equator, a typical azimuth value would be 180 degrees. For systems south of the equator, a typical value would be 0 degrees.

The azimuth angle does not apply to arrays with 2-axis tracking.

### Ground coverage ratio (GCR)

The ratio of the photovoltaic array area to the total ground area. PVWatts uses the GCR to estimate self-shading losses for the fixed open rack and 1-axis array types, and to determine when to backtrack for the 1-axis backtracking option. The GCR does not apply to the fixed open rack and 2-axis tracking array types.

For an array configured in rows of modules, the GCR is the length of the side of one row divided by the distance between the bottom of one row and the bottom of its neighboring row. An array with a low ground coverage ratio (closer to zero) has rows spaced further apart than an array with a high ground coverage ratio (closer to 1).

The ground coverage ratio must be a value greater than 0.01 and less than 0.99.

## Losses

Losses account for reduction in performance not explicitly calculated by the PVWatts model. SAM applies the total system losses to the AC power output calculated by the model. You can either enter a total loss value, or have SAM calculate the total loss value from the loss categories.

### Specify total system loss

Check this option if you want to specify a single loss value instead of values for each of the categories listed below.

### Soiling

Losses due to dust, dirt, and other foreign matter on the surface of the PV module that prevent solar radiation from reaching the cells. Soiling is location- and weather-dependent. There are greater soiling losses in high-traffic, high-pollution areas with infrequent rain.

### Shading

Reduction in the incident solar radiation caused by hills, trees, or other objects on the horizon. The default value is 3%. Note that PVWatts accounts for self shading between rows of modules for the fixed open rack and 1-axis tracking array types, so you should not include self-shading in the shading loss for those options.

### Snow

Reduction in the system's annual output due to snow covering the array. The default value is zero, assuming either that there is never snow on the array, or that the array is kept clear of snow.

**Note.** If your weather file includes snow depth data and you enable the snow model, you should set the Snow loss to zero.

### Mismatch

Electrical losses due to slight differences caused by manufacturing imperfections between modules in the array that cause the modules to have slightly different current-voltage characteristics. The default value of is 2%.

### Wiring

Resistive losses in the DC and AC wires connecting modules, inverters, and other parts of the system.

The default value is 2%.

### Connections

Resistive losses in electrical connectors in the system. The default value is 0.5%.

### Light-Induced Degradation

Effect of the reduction in the array's power during the first few months of its operation caused by light-induced degradation of photovoltaic cells. The default value is 1.5%.

### Nameplate Rating

The nameplate rating loss accounts for the accuracy of the manufacturer's nameplate rating. Field measurements of the electrical characteristics of photovoltaic modules in the array may show that they differ from their nameplate rating. A nameplate rating loss of 5% indicates that testing yielded power measurements at STC that were 5% less than the manufacturer's nameplate rating. The default value is 1%.

### Age

Effect of weathering of the photovoltaic modules on the array's performance over time. The default value is zero.

**Note.** If you specify a degradation rate on the [Lifetime and Degradation](#) page to represent module degradation, you should set the Age loss to zero.

### Availability

Reduction in the system's output cause by scheduled and unscheduled system shutdown for maintenance, grid outages, and other operational factors. The default value is 3%.

**Note.** If you specify [system availability losses](#) to represent operating losses, you should set the Availability loss to zero.

### Total system losses

The total loss, either calculated from the loss categories listed above, or equal to the total system loss you specify.

$$\begin{aligned}
 \text{Total system losses} = & 100\% \times \{ 1 - [ ( 1 - \text{Soiling} \div 100\% ) \\
 & \times ( 1 - \text{Shading} \div 100\% ) \\
 & \times ( 1 - \text{Snow} \div 100\% ) \\
 & \times ( 1 - \text{Mismatch} \div 100\% ) \\
 & \times ( 1 - \text{Wiring} \div 100\% ) \\
 & \times ( 1 - \text{Connections} \div 100\% ) \\
 & \times ( 1 - \text{Light-induced degradation} \div 100\% ) \\
 & \times ( 1 - \text{Nameplate} \div 100\% ) \\
 & \times ( 1 - \text{Age} \div 100\% ) \\
 & \times ( 1 - \text{Availability} \div 100\% ) ] \}
 \end{aligned}$$

## Shading and Snow

The shading losses represent a reduction of the incident solar irradiance due to external shading of the array caused by nearby objects such as trees and buildings. You can specify hourly beam shading losses and a single sky diffuse shading loss or import shading loss data from shade analysis tools or calculators in the Edit Shading window.

## Shading

The time series [results](#) show the effect of external shading: SAM displays the shading factor for beam radiation and the plane-of-array (POA) irradiance. The beam and diffuse shading losses that you specify both reduce the POA irradiance.

### Enabling and Disabling Shading

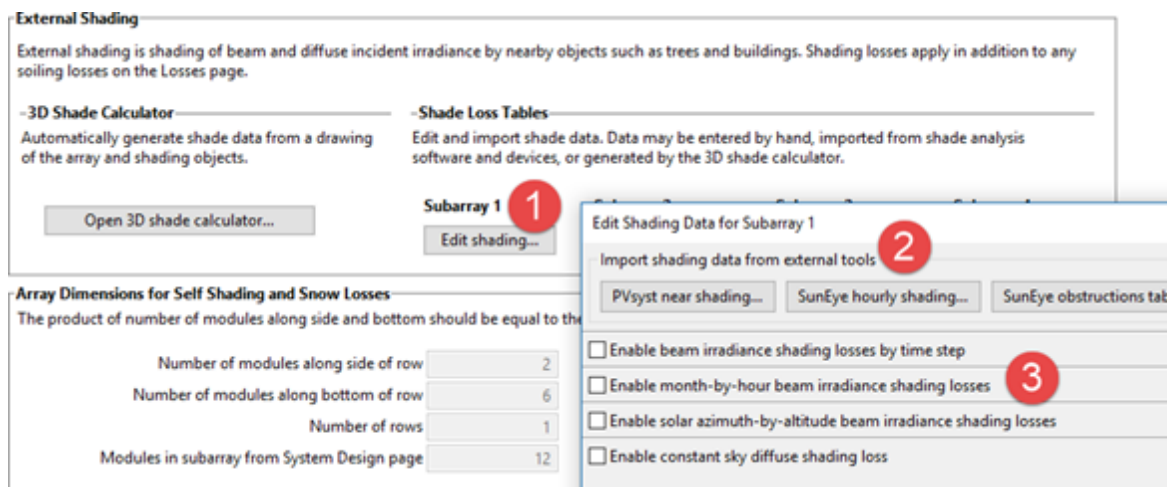
SAM offers several options for specifying shading losses.

- You must choose at least one option.
- SAM does not prevent you from enabling more than one option even if that results in an unrealistic shading model. Be sure to verify that you have enabled the set of options you intend before running a simulation.

#### To enable the external shading:

- Click **Edit Shading**.
- If you are working with a shading file from PVsyst, Solmetric Suneye, or Solar Pathfinder software, in the Edit Shading window, click the appropriate button under **Import shading data from external tools** to import the file.
- If you are using a table to specify shading factors (you can type, import, or paste values into the table), check the appropriate **Enable** box in the Edit Shading window.

**Note.** For detailed instructions on specifying shading losses, click **Help** in the Edit Shading Data window.



**Note.** If you use specify beam and diffuse shading losses, be sure to set the Shading loss under [Losses](#) to zero.

## Snow

For a description of the snow model, see the following publications available along with other technical documentation from the [SAM website](#):

- Gilman, P.; Dobos, A.; DiOrio, N.; Freeman, J.; Janzou, S.; Ryberg, D. (2018) SAM Photovoltaic



Model Technical Reference Update. 93 pp.; NREL/TP-6A20-67399

- Ryberg, D.; Freeman, J. (2017). Integration, Validation and Application of a PV Snow Coverage Model in SAM. National Renewable Energy Laboratory. 33 pp. TP-6A20-68705 available along with other technical documentation from the [SAM website](#).

Use the following output variables to explore the effect of snow cover (see [Results](#) for descriptions of the variables):

- **Array DC power loss due to snow (kW)**
- **Weather file snow depth file (cm)**

**Note.** Snow depth data is not available in the NSRDB PSM V3 dataset. It is available in the [NSRDB 1961 - 1990 Archive Data](#). This older data does not represent the best up-to-date data from the NSRDB, but may be useful for testing SAM's snow loss model.

The Ryberg (2017) paper cited above includes a United States map of annual average snow loss values that could be used to estimate snow loss using inputs on the Losses page instead of the snow model when snow depth data is not available.

SAM's snow model for photovoltaic systems estimates the loss in system output during time steps when the array is covered in snow. It uses snow depth data from the weather file, and for time steps with snow, estimates the percentage of the photovoltaic array that is covered with snow based on the array's tilt angle, plane-of-array irradiance, and ambient temperature. The model assumes that the array is completely covered with snow when the snow depth data indicates a snowfall, and that snow slides off the array as the ambient temperature increases.

#### **Estimate snow losses**

Check this option to model snow losses if the weather file on the [Location and Resource](#) page includes snow depth data.

### ▼ **System Availability**

System availability losses are reductions in the system's output due to operational requirements such as maintenance down time or other situations that prevent the system from operating as designed.

**Note.** To model curtailment, or forced outages or reduction in power output required by the grid operator, use the inputs on the [Grid Limits](#) page.

To edit the system availability losses, click **Edit losses**.

The [Edit Losses](#) window allows you to define loss factors as follows:

- Constant loss is a single loss factor that applies to the system's entire output. You can use this to model an availability factor.
- Hourly losses apply to specific hours of the year.

SAM reduces the system's output in each hour by the loss percentage that you specify for that hour. For a given hour, a loss of zero would result in no adjustment. A loss of 5% would reduce the output by 5%, and a loss of -5% would increase the output value by 5%. For subhourly simulations, SAM applies the loss factor for a given hour to each time step in that hour

## 15.2 Fuel Cell

Use the inputs on the Fuel Cell page to define the type and properties of the fuel cell and stack.

### Fuel Cell Type

The fuel cell type determines the type of fuel cell. For more detailed descriptions of the fuel cell types, see Chapter 2 of the Fuel Cell Power Model User Guide available on the [Fuel Cell Power Model website](#).

#### Molten Carbonate Fuel Cell (MCFC)

Operate at temperatures of 650°C and above and can convert fuels to hydrogen without an external reformer. The high operating temperatures and corrosive electrolyte in MCFC fuel cells causes them to be less durable than other types. They also have longer ramp rates to maintain even distribution of temperature in the cell.

#### Phosphoric Acid Fuel Cell (PAFC)

More mature cell type than the others and is the first to be used commercially. The operate at about 200°C with a lifetime of about 10 years.

#### Solid Oxide Fuel Cells (SOFC)

Operate at temperatures between 650°C and 1,000°C and can convert a wide range of fossil fuels.

#### Custom

Specify your own size, dynamic response and efficiency curves.

When you choose a fuel cell type from the list, SAM populates the following inputs with default values from the tables shown [below](#). If you choose the Custom fuel cell type, replace the values of these inputs with values for your fuel cell type.

- Unit nameplate
- Minimum unit output
- Ramp rate up limit (per unit)
- Ramp rate down limit (per unit)
- Electrical and thermal efficiency curve

You can change the default values after applying them.

**Note.** Changing the fuel cell type does not change the degradation and replacement inputs, or costs on the [System Costs](#) page. Be sure to review all of the parameters to ensure that their values are appropriate for your analysis.

### Cell and Stack Properties

The system properties define the size, dynamic response and degradation characteristics of the fuel cell and fuel cell stack. A cell stack is typically made up of several cells or units connected in series and parallel to achieve design voltage and power requirements.

**Note.** Because the fuel cell model is an energy flow model rather than an electrical model, it does not model current and voltages, so you do not need to specify how cells are configured in series and parallel.

## Size

The size parameters determine the size and number of fuel cells in the cell stack.

### Unit nameplate, kW

The rated electric power capacity of a single fuel cell in AC kilowatts.

### Minimum unit output, % of nameplate or kW

The minimum electric power output of a single fuel cell either as a percentage of fuel cell unit rated power or in kW.

### Number of units in stack

The number of fuel cells in the fuel cell stack.

### Total cell stack nameplate, kW

The rated capacity of the fuel cell cell stack in kilowatts.

$$\text{Total System Nameplate (kW)} = \text{Unit Nameplate (kW)} \times \text{Number of Units}$$

### Minimum cell stack output, kW

The minimum electric power output of the entire cell stack in AC kilowatts. SAM will not allow the cell stack to deliver power at a level below this limit during operation.

$$\text{Minimum System Output (kW)} = \text{Minimum Unit Output (\%)} \times \text{Unit Nameplate (kW)} \times \text{Number of Units}$$

or

$$\text{Minimum System Output (kW)} = \text{Minimum Unit Output (kW)} \times \text{Number of Units}$$

## Dynamic Response

The dynamic response parameters determine how long it takes the cell stack to reach its rated power after startup or to respond to increases and decreases in electric load.

**Note.** SAM attempts to operate the cell stack at the operating capacity determined by the nameplate capacity and the parameters on the [Dispatch page](#). The operating capacity is typically less than the nameplate capacity.

### Start simulation with fuel cell operating

Check this box if you want to start the simulation with the fuel cell stack at the operating capacity. If the box is not checked, the fuel cell will not start delivering heat and power at the beginning of the simulation until after the startup time is finished.

### Startup time, hours

The amount of time required in hours for the cell stack to reach its operating capacity after a shutdown, or at the beginning of the simulation if **Start simulation with fuel cell operating** is not checked.

### Shutdown time, hours

The amount of time required in hours for the cell stack power output to reach zero after a shutdown is initiated.

**Ramp rate up limit (per unit), %/hour or kW/hour**

The maximum rate of increase in the cell stack power output, either as a percentage of nameplate capacity per hour or in kilowatts per hour. The cell stack power may be required to increase after a shutdown or in response to [dispatch](#) requirements.

**Ramp rate down limit (per unit), %/hour or kW/hour**

The maximum rate of decrease in the cell stack operating power output, either as a percentage of nameplate capacity per hour or in kilowatts per hour. The cell stack power may be required to decrease for a shutdown or in response to [dispatch](#) requirements.

**Calculated ramp rate up limit (per unit), kW/hour**

If you specify the ramp rate up limit in %/hour, the calculated value shows the rate in kW/hour.

$$\text{Ramp Rate Up Limit (kW/hour)} = \text{Unit Nameplate (kW)} \times \text{Ramp Rate Up Limit (\%/hour)}$$

**Calculated ramp rate down limit (per unit), kW/hour**

If you specify the ramp rate down limit in %/hour, the calculated value shows the rate in kW/hour.

$$\text{Ramp Rate Down Limit (kW/hour)} = \text{Unit Nameplate (kW)} \times \text{Ramp Rate Down Limit (\%/hour)}$$

**Degradation**

The degradation parameters determine how the cell stack maximum power declines from year to year or after the cell stack is shut down and restarted.

**Degradation**

The annual degradation rate either as a percentage of capacity (%/year) or in kilowatts of capacity (kW/year).

**Degradation due to restarting cell stack, kW**

The degradation in cell stack maximum power caused by shutting down and restarting the stack.

**Shutdown Schedule**

The shutdown schedule determines when the cell stack is taken out of service for service, repairs, or replacement.

**Shutdown hour of year**

The hour of year that the cell stack shutdown period begins.

If the **Simulation over one year option** is active on the [Lifetime and Degradation](#) page, the maximum value is 8,760.

If the lifetime and degradation option is **Simulation over analysis period**, the shutdown hour may exceed 8,760, and you should specify the shutdown hour over the entire lifetime.

**Hours shut down, hours**

The length of the shutdown period in hours.

**No. of shutdowns**

The number of shutdown periods in the project lifetime.

## Stack Replacement

The stack replacement parameters determine the number and timing of cell stack replacements over the project lifetime. The project lifetime is the same as the analysis period on the Financial Parameters input page.

**Note.** If you choose to model cell stack replacements, be sure to set the replacement cost on the [System Costs](#) page to the cost of replacing the cell stack.

### No replacements

Do not model cell stack replacement.

### Replace at specified capacity

Replace the cell stack when the fuel cell maximum power available reaches the specified capacity.

### Fuel cell stack replacement threshold, %

The percentage of the cell stack nameplate

### Replace at specified schedule

Replace the cell stack on a pre-determined annual schedule.

To set the schedule, click **Edit array** and type a 1 in the row of the table for each year that the fuel cell stack is replaced. Type a zero for remaining rows. The first row in the table represents Year 1 in the project cash flow, or the first year that the system operates.

### Fuel cell stack replacement threshold, %

### Fuel cell replacement schedule

## Efficiency

### Default Parameter Values

The default parameters for the three fuel cell types are from the [Fuel Cell Power Model](#).

### Default Size and Dynamic Response Parameters

The percentages in the following table are percentage of nameplate capacity.

Parameter	MCFC	PAFC	SOFC
Unit Nameplate	300 kW	400 kW	200 kW
Minimum unit output	20%	133%	30%
Ramp rate up limit	17 kW/h	100%/hr	250%/hr
Ramp rate down limit	17 kW/h	100%/hr	250%/hr

### Default Efficiency Curves

The default electrical and thermal efficiency curves for each fuel cell type are shown in the tables below.

**Molten Carbonate (MCFC)**

Power (%)	Electrical Efficiency LHV (%)	Maximum Heat Recovery (%)
0.0	3.0	50
16.1	19.0	50
25.5	22.8	50
34.8	28.5	50
44.1	33.9	50
53.4	38.4	50
62.7	43.0	49
72.0	45.3	48
81.4	47.2	47
90.7	47.0	46
100	46.1	45

**Phosphoric Acid (PAFC)**

Power (%)	Electrical Efficiency LHV (%)	Maximum Heat Recovery (%)
0.0	10.5	71.6
10.0	20.3	63.8
20.0	26.9	58.5
30.0	31.4	54.9
40.0	34.1	52.8
50.0	35.9	51.3
60.0	36.9	50.5
70.0	37.5	50.0
80.0	37.7	49.8
90.0	37.7	49.9
100.0	37.4	50.0

**Solid Oxide (SOFC)**

Power (%)	Electrical Efficiency LHV (%)	Maximum Heat Recovery (%)
0.0	3.0	50
16.1	21.0	50
25.5	25.2	50
34.8	31.5	50
44.1	37.3	50
53.4	42.6	50
62.7	47.4	49
72.0	49.9	48
81.4	52.0	47
90.7	51.8	46
100	50.7	45

## 15.3 Dispatch

The fuel cell Dispatch page provides options for defining how to operate the fuel cell stack and battery bank.

The battery storage dispatch options available depend on whether the system is in front of the electric utility meter (PPA Single Owner financial model) or behind the meter (Commercial financial model).

### Fuel Cell Operation

The fuel cell operation parameters determine the fuel cell operates.

### Dispatch Options

#### Fixed output

Operate the fuel cell at a fixed percentage of the fuel cell rated capacity at all times.

#### Fixed output percentage

For the fixed output option, specify the percentage of the fuel cell rated capacity from the [Fuel Cell](#) page. This input is disabled unless you choose the **Fixed output** dispatch option.

#### Follow electric load

Operate the fuel cell to follow the electric load defined on the [Electric Load](#) page.

**Note.** This option does not apply to the front of meter configuration (PPA single owner financial model).

### Manual dispatch

Operate the fuel cell according to the **Manual Dispatch Model** parameters and schedules.

### Input dispatch

Operate the fuel cell according to a time series dispatch profile that you provide.

### Input dispatch schedule

For the input dispatch option, click **Edit array** to provide a time series array of either kW or percentage values at which to operate the fuel cell in each simulation time step.

## Operation Options

### Allowed to shut down

Allow the fuel cell to shut down completely when it is not needed to meet dispatch requirements.

### Idle at minimum power

Run the fuel cell at the minimum unit output from the [Fuel Cell](#) page when it is not needed to meet dispatch requirements.

## Storage Dispatch Controller (Behind Meter)

The dispatch controller determines the timing of battery charges and discharges and discharge limits. For behind-the-meter (BTM) systems (Residential, Commercial, or Third Party Financing financial models), you can choose a dispatch option where SAM determines the timing automatically, use the manual dispatch controller to define the timing using hour-by-month weekday and weekend matrices, or input a time series battery power signal.

## Dispatch Options

Choose the dispatch option that most closely represents how you would like the battery to be charged and discharged.

### Peak Shaving

The peak shaving options attempt to operate the battery to reduce peak demand over a forecast period, considering the load and solar resource over the period. Use this option to reduce monthly demand charges when the rates on the [Electricity Rates](#) page include demand rates.

#### Peak-shaving one-day look ahead

For each day, dispatch the battery based on the solar resource and load data over the next 24 hours. The look-ahead option is based on a perfect prediction of the future load and solar resource data.

#### Peak shaving one-day look behind

Similar to the one-day look ahead option, but based on the previous 24 hours of solar resource and load data for the prediction. The look-behind option adds some uncertainty to the dispatch because the prediction of the solar resource and load is based on previous day's load and solar resource.

### Input grid power targets

The grid power target option attempts to operate the battery in response to grid power targets that you specify. In each time step, the controller compares the electric load to the power target, charges the battery when the load is less than the target, and discharges when the load is greater than the target. You can specify a constant annual target, twelve constant monthly targets, or a target for each time step.



Choose **Input grid power targets**, and then choose either **Monthly power targets** or **Time series power targets**:



### Monthly power targets

Choose this option to specify a either a single grid power target for the entire year, or a grid power target for each month. For **Monthly grid power targets**, Click **Edit values** to specify the targets. To apply a single target to the entire year, enter the target as a single value in the Edit Values window and click **Apply**.

### Time series power targets

Choose this option to enter a grid power target for each time step in the simulation. For **Time series grid power targets**, click **Edit array** to specify the targets.

## Input battery power targets

The battery power targets option operates the battery in response to battery power targets you specify. In each time step, the controller attempts to charge to the negative power value you enter, or discharge to the positive power value you enter.

Choose **Input battery power targets**, and then enter the battery power target data.

### Time series battery power targets

Click **Edit array** and import or copy and paste an array of battery power values in kW, where discharge power is positive, charge power is negative. The array must have the same number of rows as simulation time steps: For hourly simulations, 8,760 rows, for for 15-minute simulations 35,040 rows, etc.

## Manual dispatch

For the manual dispatch option, you specify the timing of battery charges and discharges using up to six dispatch periods and a set of weekday and weekend hourly profiles by month under **Manual Dispatch**.

The manual dispatch controller assumes that the system meets the electric load before charging the battery. For any time step with "charge from system" allowed, the system charges the battery with any power in excess of the load.

## Price signal forecast

The price signal forecast option operates the battery to minimize the electricity bill over the next 24 hours by considering the load, system power output, and electricity rates. It uses the cycle degradation penalty to consider the cost of future battery replacements.

Choose **Price signal forecast**, and then choose a cycle degradation penalty method and assign a penalty if needed.

### Cycle degradation penalty method

For the price signal forecast option, choose a method for estimating the cost of cycling the battery: Choose **Calculate automatically** if you want SAM to calculate the cost, or choose **Enter penalty** to enter a cost per cycle-kWh value.

If you choose the "calculate automatically" option, SAM reports the calculated penalty as **Computed cycle degradation penalty** in the [battery time series results](#).

### Cycle degradation penalty

The penalty in \$/cycle-kWh of battery total capacity for cycling the battery. You can either enter a single value, or click the blue "val/sched" button to enter a different penalty for each year of the analysis period.

## Charge Options

For the dispatch options except manual dispatch, choose whether the battery can charge from the grid, from the system, or both. For the manual dispatch option, use manual dispatch inputs to specify how the battery is charged.

### Battery can charge from grid

Allow power from the grid to charge the battery.

### Battery can charge from system

Allow power from the power system to charge the battery.

## Storage Dispatch Controller (Front of Meter)

The dispatch controller determines the timing of battery charges and discharges, and discharge limits. For front-of-meter systems (PPA, Merchant Plant financial models), you can either choose an automated dispatch model where SAM determines the timing automatically, input your own desired power signal for the battery, or define the timing manually using the monthly time-of-day matrices.

The manual dispatch controller allows you to maximize the value of storage by matching storage dispatch to the time-of-delivery (TOD) factors on the [Revenue](#) page for the Single Owner model, or the Time of Delivery factors page for the other PPA financial models.

## Dispatch Options

Choose the automated dispatch model that most closely represents how you would like the battery to be charged and discharged, or choose the manual dispatch option to specify the timings manually.

### Automated dispatch look ahead

For each day, look ahead to the next day's available power from the system and time-of-delivery (TOD) multipliers, and operate system to maximize revenue.

### Automated dispatch one day look behind

For each day, look behind to the previous day's available power from the system time-of-delivery (TOD) multipliers, and operate system to maximize revenue.

### Automated dispatch custom weather file

Similar to the look ahead automated dispatch option, except, for the PV-battery configuration, use a different weather file for the solar resource forecast.

### Dispatch to custom time series

Choose this option to charge and discharge the battery according to a time-series dispatch signal.

### Manual dispatch

No automation. You specify the timing of battery charges and discharges using up to six dispatch periods and a set of weekday and weekend hourly profiles by month under **Manual Dispatch Model**.

The manual dispatch controller always assumes that PV meets the electric load before charging the

battery. The PV system will charge the battery with any excess if that option has been selected for the current time.

## Charge Options

For non-manual dispatch options, choose the source of power for charging the battery.

### Battery can charge from grid

Allow the grid to charge the battery.

### Battery can charge from system

Allow the system to charge the battery.

### Battery can charge from clipped system power

Available for any of the three automated dispatch options for a PV system with DC-connected batteries only. This option will use any DC array power in excess of the inverter's nominal DC input power to charge the battery.

## Automated Dispatch Options

When you choose an automated dispatch option, provide additional information.

### Frequency to update dispatch

For any of the three automated dispatch options, determines how often a new dispatch decision is made.

### Look-ahead period

For the automated look ahead and automated custom weather file option, the number of hours ahead of the current time step to use for the dispatch decision in the current time step.

### Cycle degradation penalty option

For any of the automated dispatch options, choose a method for estimating the cost of cycling the battery: Choose **Calculate automatically** if you want SAM to calculate the cost, or choose **Enter penalty** to enter a cost per cycle-kWh value.

If you choose the "calculate automatically" option, SAM reports the calculated penalty as **Computed cycle degradation penalty** in the [battery time series results](#).

### Cycle degradation penalty

When you choose the "enter penalty" option for the cycle degradation penalty option, this is the penalty in \$/cycle-kWh of battery total capacity for cycling the battery. You can either enter a single value, or click the blue "val/sched" button to enter a different penalty for each year of the analysis period.

### Custom Weather File for Forecast

For the automated dispatch custom weather file option, click **Browse** to choose a weather file in the SAM CSV format to use for the solar resource forecast that is different from the file used for the simulation.

## Custom Time Series Dispatch

For the dispatch to custom time series option, provide a time series of battery power values. SAM will attempt to charge and discharge the battery to meet the battery power target values.

### Time series battery power targets

Click **Edit array** to enter time series battery power values. A negative power value for a time step

indicates the battery controller should attempt to charge the battery at the given rate in that time step. A positive power value indicates the battery should discharge.

## Manual Dispatch Model

The manual dispatch option allows you to manually specify the timing of battery charges and discharges. Choose the **Manual dispatch** option under **Dispatch Options** to make the manual dispatch inputs active.

You can specify how you want to charge the battery (from grid or system), and whether to allow battery discharging for up to six periods. Use the weekday and weekend schedules to specify the hour of day and month of year that each period applies.

### Charge from system

For each period that you want to allow the battery to be charged by power from the system, check the box in the **Charge from system** column.

### Charge from grid

For each period that you want to allow the battery to be charged by power from the grid, check the box in the **Allow** column, and specify the percentage of the battery's state of charge that can be charged from the grid over the time step.

For example, for hourly simulations, a value of 25% would allow the grid to deliver 25% of the battery state of charge at the beginning of the hour over the hour. The purpose of the percentage is to prevent the battery from being charged too quickly. See the example below under **Discharge** for more details.

**Note.** For subhourly simulations, the charge and discharge percentages apply to the subhourly time step even though the periods are defined in hours.

For a behind-the-meter application, if **Charge from grid** and **Charge from system** are both checked for a given period, and if in a time step in that period the system power is greater than the [load](#), power from the grid will supplement the system power to meet the battery charge requirement.

If **Charge from grid** and **Allow discharging** are both checked for a given period, and if in a time step in that period the battery state of charge is above the minimum state of charge, the battery discharges until it reaches the minimum state of charge, at which point it starts charging from the grid, either until it reaches the maximum state of charge, or until the time period changes to one that does not allow charging from the grid.

### Discharge

For each period that you want to allow the battery to discharge, check the box in the **Allow** column, and specify the percentage of the battery's available charge that can be dispatched over the time step. The available charge is defined by the minimum and maximum state of charge values under **Charge Limits and Priority**.

For example, if Period 3 is the four consecutive hours between 3 pm and 6 pm, the discharge capacity is 25%, and the charge limits are 30% and 96%, for an hourly simulation, that would allow up to 25% of the charge the battery holds at the beginning of the 3 pm hour to be discharged over the hour. For the 4 pm hour, 25% of the charge at the end of the 3 pm hour would be available, and so on until the end of Period 3. The 25% value would discharge the battery over the full four-hour period. (A 20% value would have the same effect for a 5-hour period, i.e., if Period 3 were between 3 pm and 7 pm.)

For a one-minute simulation, a capacity to discharge of 25% would allow up to 25% of the available charge to be dispatched *every minute* over Period 3, so a smaller percentage would be required to allow the battery to discharge over the full four-hour period.

### Weekday and Weekend Schedules

To define the hour of day and month of year that each period applies, use your mouse to select a rectangle in the schedule matrix, and use your keyboard to type the period number (1-6). The number you type should appear in the rectangle.

See [Weekday-weekend Schedules](#) for a step-by-step description of how to use the schedule matrices.

## 15.4 System Costs

The fuel cell System Costs page provides access to variables that define the installation and operating costs of the project. Debt-related and tax costs are specified on the [Financial Parameters](#) page.

SAM uses the variables on the System Costs page to calculate the project investment cost and annual operating costs reported in the project [cash flow](#) and used to calculate cost metrics.

Variable values in boxes with white backgrounds are values that you can edit. Boxes with blue backgrounds contain calculated values or values from other pages that SAM displays for your information.

SAM provides the categories under **Direct Capital Costs** and **Indirect Capital Costs** for your convenience to help keep track of project installation costs. Only the **Total Installed Cost** value affects the cash flow calculations, so you can assign capital costs to the different cost categories in whatever way makes sense for your analysis. For example, you could assign the cost of designing the array to the module cost category or to the engineering category with equivalent results. After you assign costs to the categories, you should verify that the total installed cost value is what you expect. SAM accounts for the total installed cost in Year 0 of the project [cash flow](#).

The Operation and Maintenance Costs categories are where you specify recurring project costs. SAM reports these annual costs in the project [cash flow](#) under the Operating Expenses heading.

#### Notes.

The default cost values that appear when you create a file or case are intended to illustrate SAM's use. The cost data are meant to be realistic, but not to represent actual costs for a specific project. For more information and a list of online resources for cost data, see the technology pages on the [SAM website](#).

The System Costs page only available for cases with a cash-flow-based financial model. It is not available with the No Financial Model option or the LCOE Calculator financial model.

### Direct Capital Costs

A direct capital cost represents an expense for a specific piece of equipment or installation service that applies in year zero of the cash flow.

**Note:** Because SAM uses only the total installed cost value in cash flow calculations, how you distribute costs among the different direct capital cost categories does not affect the final results.

A direct capital cost represents an expense for a specific piece of equipment or installation service that applies in year zero of the cash flow.

**Note:** Because SAM uses only the total installed cost value in cash flow calculations, how you distribute costs among the different direct capital cost categories does not affect the final results.

### Module (\$/Wdc or \$/Unit)

You can specify the module cost either in \$/Wdc or \$/unit:

- Dollars per watt multiplied by **System nameplate capacity** from the [PV System](#) page, or
- Dollars per unit, where the number of modules is assumed to be one.

### Inverter (\$/Wac or \$/Unit)

For PVWatts, the inverter cost is either dollars per watt AC or DC, or dollars per inverter:

- Dollars per watt DC multiplied by the system nameplate capacity from the [PV System](#) page, or
- Dollars per watt AC multiplied by the system nameplate capacity and divided by the DC to AC Derate Factor on the [System Design](#) page, or
- Dollars per unit where the number of inverters is assumed to be one.

### Battery rated power, \$/kW

Battery cost per unit of **Battery rated power**, which is the maximum discharge power (kW AC) from the [Battery Storage](#) page.

### Battery rated capacity, \$/kWh

Battery cost per unit of **Battery rated capacity**, which is the nominal bank capacity (kWh DC) from the [Battery Storage](#) page.

**Note.** If the battery is not enabled on the Battery Storage page, SAM sets the battery costs to zero.

The other direct capital cost categories, **Balance of system equipment**, **Installation labor**, and **Installer margin and overhead** can be specified using five units. SAM calculates the total amount for each category as shown below.

\$

A fixed cost in dollars.

### PV \$/Wdc

A cost proportional to the PV array's DC nameplate capacity, equal to the **System nameplate size on the** on the [PV System](#) page.

### Battery \$/kW

A cost proportional to the battery's nominal power rating, equal to the **Maximum charge power (AC)** on the [Battery Storage](#) page.

### Fuel Cell \$/kW

A cost proportional to the fuel cell stack nameplate capacity, equal to the **Cell stack nameplate** on the [Fuel Cell](#) page.

### Contingency (%)

A percentage of the sum of the module, inverter, balance of system, installation labor, and installer margin and overhead costs that you can use to account for expected uncertainties in direct cost estimates.

### Total Direct Cost (\$)

The sum of module, inverter, balance of system, installation labor, installer margin and overhead costs, and contingency costs.

### Indirect Capital Costs

An indirect cost is typically one that cannot be identified with a specific piece of equipment or installation service.

**Note:** Because SAM uses only the total installed cost value in cash flow calculations, how you distribute costs among the different indirect capital cost categories does not affect the final results.

The five indirect cost categories, **Permitting and environmental studies**, **Engineering and developer overhead**, **Grid interconnection** are each calculated as the sum of four values expressed in the following units:

#### % of Direct Cost

A percentage of the **Total direct cost** value shown under Direct Capital Costs.

#### PV \$/Wdc

A cost proportional to the PV array's DC nameplate capacity, equal to the **System nameplate size on the** on the [PV System](#) page.

#### Battery \$/kW

A cost proportional to the battery's nominal power rating, equal to the **Maximum charge power (AC)** on the [Battery Storage](#) page.

#### Fuel Cell \$/kW

A cost proportional to the fuel cell stack nameplate capacity, equal to the **Cell stack nameplate** on the [Fuel Cell](#) page.

#### \$

A fixed cost in dollars.

### Land Costs

SAM calculates the total land cost as the sum of **Land area**, **Land purchase**, and **Land prep. and transmission**. The land cost categories use the Cost \$/acre category in addition to the categories for the other indirect costs.

**Note.** The land area input is independent of the PV array size or other input parameters. If you want to include land area costs in your analysis, be sure to specify a land area in acres that is appropriate for your system's design.

### Sales Tax (%)

#### Sales tax basis, %

The percentage of total direct cost used to calculate sales tax amount.

SAM calculates the total sales tax amount by multiplying the sales tax rate from the [Financial Parameters](#) page by the sales tax basis on the System Costs page:

$$\text{Total Sales Tax (\$)} = \text{Sales Tax Rate (\%)} \times \text{Sales Tax Basis (\%)} \times \text{Total Direct Cost (\$)}$$

For an explanation of the effect of sales tax on income tax, see **Sales Tax** on the [Financial Parameters](#) topic for the financial model you are using (Residential, Commercial, Single Owner, etc.)

## Total Installed Cost

The total installed cost is the sum of all of the direct and indirect capital costs that you specify. SAM uses this value to calculate the project's [net capital cost](#), which is the total installed cost less any cash incentives on the [Incentives](#) page and plus any additional financing costs from [Financial Parameters](#) page.

### Total installed cost (\$)

The sum of total direct cost and total indirect cost.

### Total installed cost per capacity (\$/Wdc or \$/kW)

Total installed cost divided by the total system rated or nameplate capacity. This value is provided for reference only. SAM does not use it in cash flow calculations.

# 16 Biomass Combustion

The biopower model is a performance- and cost-modeling tool for assessing the biomass power resource of a location. SAM can model biopower plants that use crop and wood residues as a feedstock. It can also model a supplementary coal feedstock for a co-fired plant, or completely coal-fed power plant for comparison with a biopower option. You can also specify custom feedstocks.

You specify the basic mass and energy balances for the plant's combustor and steam turbine.

SAM generates performance [metrics](#) such as heat rate, thermal efficiency, and capacity factor. It also generates [financial metrics](#) such as the levelized cost of energy (LCOE), net present value (NPV), and payback period.

Dedicated biomass power facilities are generally on the order of 1 – 60 MW, but SAM can evaluate plants of any size.

For a technical description of the biopower model, see Jorgenson, J.; Gilman, P.; Dobos, A. (2011). Technical Manual for the SAM Biomass Power Generation Model. 40 pp.; NREL Report No. TP-6A20-52688. <http://www.nrel.gov/docs/fy11osti/52688.pdf>

## 16.1 Ambient Conditions

The Ambient Conditions page allows you to choose a weather file to specify ambient conditions for the Steam Rankine Cycle for a biomass power system. The weather file contains solar resource data, but is also suitable for the biomass power model.



The [biomass power](#) model uses data from a weather file to describe ambient conditions for the [Rankine steam cycle](#), and for modeling feedstock drying. It uses separate data set to describe the biomass resource ([feedstock](#)). The geographical coordinates in the weather file determines the location for the [feedstock](#).

Ambient conditions also affect biomass composition, but on a monthly rather than hourly timescale. SAM calculates average monthly temperature, pressure, and humidity values from the hourly values in the weather file, and uses those values to represent the average ambient conditions for each month of the year. SAM uses the same set of twelve monthly average values for each year of the plant's life.

### Important Note!

The biomass power model requires a weather file with global horizontal irradiance (GHI) and relative humidity data that is not available in all files from the National Solar Radiation Database (NSRDB).

[Typical meteorological year \(TMY\)](#) files from the NSRDB PSM V3 dataset do not have relative humidity data, but the single year data does. To download a single year file, use the choose year option to download a file as described under "Download Weather Files" below.

The legacy NSRDB MTS1 (NSRDB 1961 - 1990 TMY2) weather files have both GHI and relative humidity data, but the MTS1 data is out of date and only has files for a few hundred weather stations in the United States.

You can access these legacy files from the [NSRDB archives](#).

Please contact SAM Support at [sam.support@nrel.gov](mailto:sam.support@nrel.gov) if you need help finding weather data to use for your project.

The Location and Resource page provides access to the solar resource library, which is a collection of weather files stored on your computer. When you first install SAM, it comes with a few default weather files in the library. As you use SAM for your own projects, you should add files to build your own library. Once files are in your library, you can use them for different projects and with different versions of SAM.

The Solar Resource Library interface shows a search bar and a table of weather files. The table has columns for Name, Latitude, Longitude, Time zone, Elevation, and Station ID. Below the table, there is a list of folders scanned by SAM, including 'C:\Users\<user>\SAM Downloaded Weather Files', 'F:\little\_rock\_ar', and 'F:\PVGIS 5'. There are also buttons for 'Add/remove weather file folders...' and 'Refresh library'.

Name	Latitude	Longitude	Time zone	Elevation	Station ID
daggett_ca_34.865371_-116.783023_psmv3_60_tmy	34.85	-116.78	-8	561	91486
des_moines_ia_41.586835_-93.624959_psmv3_60_tmy	41.57	-93.62	-6	263	757516
faroo_nd_46.9_-96.8_mts1_60_tmy	46.9	-96.8	-6	274	14914

**Weather Data Information**

The following information describes the weather file for the Solar Resource library above. This is the file SAM will use when you click Simulate.

Weather file:

**-Header Data from Weather File-**

City	<input type="text" value="-"/>	Station ID	<input type="text" value="91486"/>	Latitude	<input type="text" value="34.85 *N"/>
State	<input type="text" value="-"/>	Data Source	<input type="text" value="NSRDB"/>	Longitude	<input type="text" value="-116.78 *E"/>
Country	<input type="text" value="-"/>	Elevation	<input type="text" value="561 m"/>	Time zone	<input type="text" value="GMT -8"/>

**-Annual Averages Calculated from Weather File Data-**

Global horizontal	<input type="text" value="NaN"/>	kWh/m <sup>2</sup> /day	Average temperature	<input type="text" value="17.3"/>	*C
Direct normal (beam)	<input type="text" value="7.65"/>	kWh/m <sup>2</sup> /day	Average wind speed	<input type="text" value="2.4"/>	m/s
Diffuse horizontal	<input type="text" value="1.27"/>	kWh/m <sup>2</sup> /day	*NaN indicates missing data.		

**Weather file for simulation.**

**Information from weather file header.**

**Summary data calculated from time series data.**

There are two ways to add files to your solar resource library:

**1. Download a weather file or files from the NREL National Solar Radiation Database (NSRDB)**

Use the download weather file options and click **Download and add to library** to get the most up-to-date data for long-term cash flow analysis, single-year analysis, and P50/P90 analysis, or to download legacy data from the NSRDB.

**2. Add weather file folders**

If you have weather files from a source other than the NSRDB or that you've downloaded yourself from the NSRDB website, put them in a folder, and then click **Add/remove weather file folders** to add the folder to your solar resource library folder list.

**See also**

- [Weather File Formats](#)
- [Weather Data Elements](#)
- [Typical and Single Year](#)
- [Time and Sun Position](#)
- [Folders and Libraries](#)
- [Weather Data and LK](#)

**Notes.**

You may want to model your system using weather data from several different sources and locations around your project site to understand how sensitive your analysis results are to the weather assumptions, and how much variation there is in the data from the different weather files.

You can compare results for a system using more than one weather file in a single case by using SAM's [parametric simulation](#) option.

For more information about weather data, including where to find data for locations outside of the United States, see the [SAM website](#).

For a helpful discussion of weather data and power system simulation, see Sengupta et al., (2015) "Best Practices Handbook for the Collection and Use of Solar Resource Data for Solar Energy Applications," NREL Report No. TP-5D00-63112 ([PDF 8.9 MB](#)).

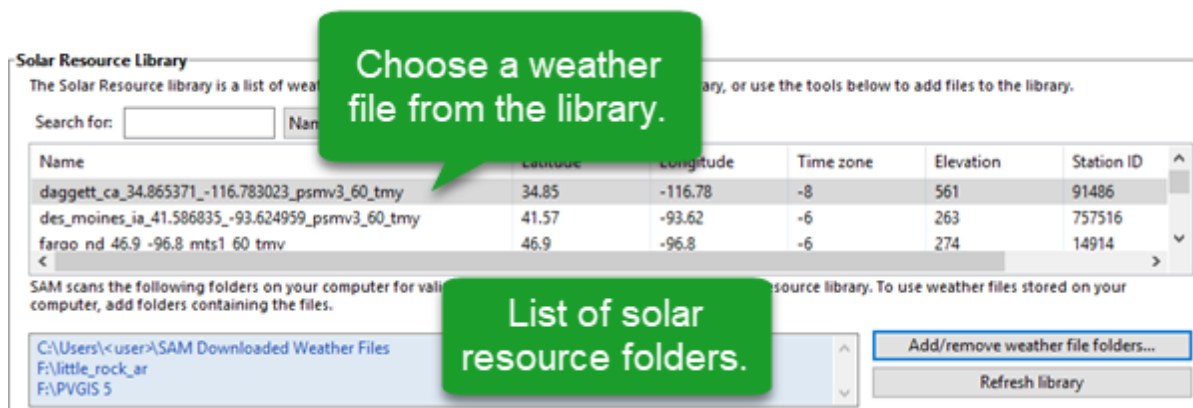
## ▼ Solar Resource Library

SAM's solar resource library displays information from weather files in your solar resource data folders. The default solar resource library that comes with SAM contains weather files for a few locations around the United States for the default configurations. As you use SAM, use **Add/remove weather file folders** to build a library of files for locations you frequently use as described in [Folders and Libraries](#).

### To choose a file from the solar resource library:

- Click the location name in the list. You can type a few letters of the file name in the Search box to filter the list.

The full file name and information about the selected file appears under **Weather Data Information**. To see the data in the file, click **View data**.



### **Add/remove weather file folders**

Use the folder settings to tell SAM what folders on your computer it should scan for weather files to build the solar resource library. SAM adds any files it can identify as valid weather files in each folder you specify to the library.

Before adding a file to the library, SAM checks the data in the file displays a message if it finds any problems with the data in the file.

SAM will only add valid weather files to the library. If you add a folder that contains CSV files that are not in the SAM CSV format, it will not add those files to the library.

The list of solar resource folders are the folders that SAM scans for weather files to build the solar resource library.

### Refresh library

Refresh the library after adding files to the weather file folder. In most cases, SAM should automatically refresh the library as needed, but you may need to manually refresh it.

## Download Weather Files

SAM can download weather files from the latest National Solar Radiation Database (NSRDB) Physical Solar Model (PSM) datasets. For all NSRDB datasets, SAM can download single-year files or typical-year files.

**Download Weather Files**  
Download the latest weather files from the NSRDB to add to your solar resource library: Download a typical-year (TMY) file for most long-term cash flow analyses, or choose files to download for single-year or P50/P90 analyses. See Help for details.

One location     Multiple locations     60-minute     30-minute     Legacy data (advanced)

Type a street address or latitude, longitude (skip for advanced)    Default TMY file    Download and add to library...

[Go to SAM website Weather Page for information about NSRDB and PVGIS, and for links to other sources of solar resource data](#)

**Note.** For locations not in the NSRDB, you can download EPW files from the European Commission Photovoltaic Geographical Information System [PVGIS V5 website](#) to a folder on your computer, and then use the [folder settings window](#) to add the folder to the list of folders SAM scans to build the solar resource library.

### To download a typical-year weather file for a single location:

1. Replace the text "Type a location name, street address or latitude and longitude" with a street address, city and state or country name, zip code, or latitude longitude pair. For example:
  - Golden, Colorado
  - golden, co
  - 15013 Denver West Parkway, Golden CO 80401
  - 80401
  - thimpu, bhutan
2. Click **Download and add to library**.

For more instructions to download multiple files, see [Weather File Download Instructions](#) below.

SAM converts the address you type to a latitude and longitude pair for the location, and submits that information to the NSRDB along with your email address. If the location is in the region covered by the NSRDB, it returns a weather file in the SAM CSV format, and adds it to your weather file download folder. Otherwise, it displays a message telling you the location is not covered by the NSRDB.

When you first install SAM, it creates the *SAM Downloaded Weather Files* folder and assigns it as your weather file download folder. You can change the weather file download folder by clicking **Add/Remove**

**weather file folders.** See [Folders and Libraries](#) for details.

When the download finishes, SAM displays a prompt asking you if you want to open the weather file download log. This prompt is the indication that the download finished. During the download and before that prompt appears, SAM may become unresponsive. If it does, wait for the prompt to avoid interrupting the download.

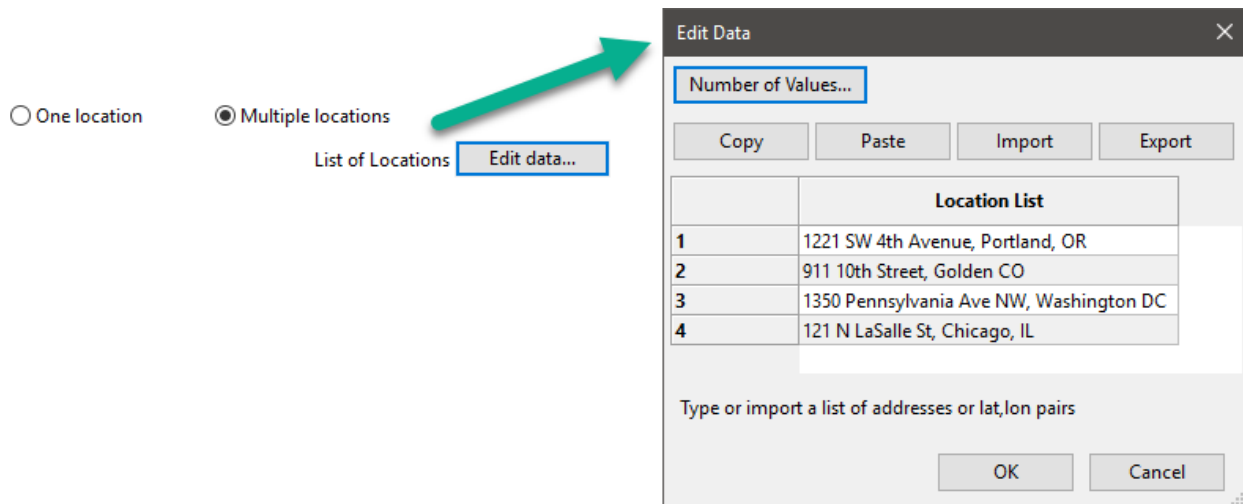
The weather file download log is a text file that SAM creates in your weather file download folder, and serves as a record of all of the files you download from the NSRDB. For each download, it lists the date and time of the request, the information you provided, the URL SAM generated, the name of the file returned by the NSRDB, or error messages it returns if the download fails. This information is useful for troubleshooting weather file download problems.

**Note.** Downloading multiple weather files from the NSRDB can take a long time. If you download files for multiple locations or years, be prepared to wait for the files to download. The download log file reports the time it takes for each file to download. Download times depend on your internet connection and computer. For a new computer with a fast connection, downloading and processing a single file takes about 10 seconds.

### One location, Multiple locations

Choose **One location** to download a weather file for a single location.

Choose **Multiple locations** to submit a list of locations and download a file or files for each location. For Multiple locations, click **Edit data** to open the Edit Data window where you can enter the list of locations and click **Number of Values** to enter the number of locations in the list.

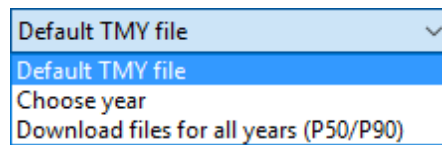


### 60-minute, 30-minute

Choose **60-minute** to download weather files with hourly time steps or 8,760 data records.

Choose **30-minute** to download files with 30-minute time steps or 17,520 data records. Thirty-minute data is not available for the NSRDB SUNY International dataset.

### Download options



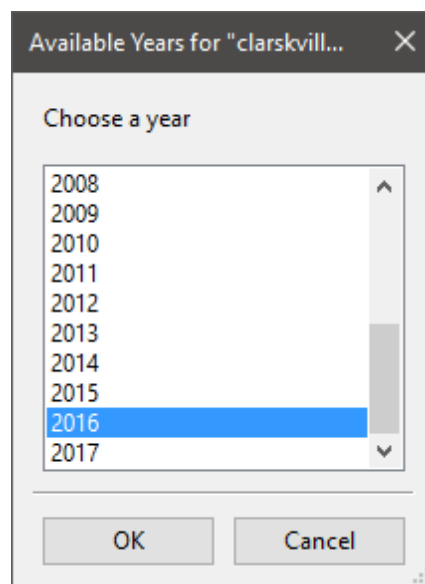
### Default TMY file

Download a typical meteorological year weather file for the location or locations you specified.

Typical year data is appropriate when you are using simulation results for a single year to make cash flow calculations over a multi-year period.

### Choose year

Choose a single year file to download. After you click the Download button, SAM prompts you with a list of available years for each location you requested to choose a year.



The single year option is appropriate when you want to see how the system would perform in a particular year. For example, for a residential or commercial system, if you have measured building load data for a given year, you could use weather data for the same year to see how the system's power output compares to the load.

If you use both **Choose year** and **Multiple locations**, SAM prompts you for a year for each location.

SAM queries the NSRDB to generate the list of available years. The list of available years varies between regions.

### Download files for all years (P50/P90)

Download a set of single-year files covering the range of historical data (nineteen files for 1998 through 2017 as of October 2018 for PSM data). When you click download, SAM creates a folder in your weather file download folder to store the single year files based on the location address or latitude-longitude pair you typed. It also downloads the typical meteorological year (TMY) file for the location and stores it in your weather file download folder.

SAM appends an underscore with the year to the file name so that the P50 P90 simulations work

correctly. See [P50/P90 Simulations](#) for details.

If you choose to download files for all years with **Multiple locations**, SAM downloads a set of files for each location, and puts the files for each location in a separate folder. Note that this may take a long time.

## Weather File Download Instructions

### Examples of valid street address or latitude-longitude pairs:

- golden colorado
- golden, co
- 15013 Denver West Parkway, Golden CO 80401
- 80401
- 39.75, -105.15
- Super Market, F-6 Markaz, Islamabad, Pakistan
- New Delhi, India

**Note.** When the download finishes, SAM displays a prompt asking you if you want to open the weather file download log. This prompt is the indication that the download finished. During the download and before that prompt appears, SAM may become unresponsive. If it does, wait for the prompt to avoid interrupting the download.

### To download an hourly typical-year (TMY) weather file from the NSRDB (use this option for most situations):

1. Click **One location**.
2. Type either a street address or latitude-longitude pair.
3. Click **60-minute**.
4. Choose **Default TMY File**.
5. Click **Download and add to library**.

### To download files for more than one location:

1. Click **Multiple locations**.
2. Click **Edit data**.
3. In the Edit Data window, click **Number of Values** and type the number of locations to create a table with a row for each location.
4. Type a street address or latitude-longitude pair in the table for each location.
5. Click **OK**.
6. Choose a time step, **60-minute** for hourly, or **30-minute** for 30-minute data.
7. Choose the type of file(s) you want to download as described below.
8. Click **Download and add to library**.

## Weather Data Information

**Weather Data Information**  
The following information describes the weather file selected from the Solar Resource library above. This is the file SAM will use when you click Simulate.

Weather file:  [View data](#)

**-Header Data from Weather File-**

City	<input type="text" value="-"/>	Station ID	<input type="text" value="91486"/>	Latitude	<input type="text" value="34.85 *N"/>
State	<input type="text" value="-"/>	Data Source	<input type="text" value="NSRDB"/>	Longitude	<input type="text" value="-116.78 *E"/>
Country	<input type="text" value="-"/>	Elevation	<input type="text" value="561 m"/>	Time zone	<input type="text" value="GMT -8"/>

**-Annual Averages Calculated from Weather File Data-**

Global horizontal	<input type="text" value="NaN"/>	kWh/m <sup>2</sup> /day	Average temperature	<input type="text" value="17.3"/>	°C
Direct normal (beam)	<input type="text" value="7.65"/>	kWh/m <sup>2</sup> /day	Average wind speed	<input type="text" value="2.4"/>	m/s
Diffuse horizontal	<input type="text" value="1.27"/>	kWh/m <sup>2</sup> /day	*NaN indicates missing data.		

### Weather File

The path and name of the active weather file SAM will use for simulation. Download a different file from the NSRDB, or click a different file name in the library to change the file.

### View data

Display weather file data in the [time series data viewer](#).

**Note.** You can also see the data after running a simulation on the Results page [data tables](#) and [time series graphs](#).

### Header Data from Weather File

Header data is information in the weather file that describes the location and type of data in the file. SAM uses the time zone, elevation, latitude and longitude to calculate the sun position during simulations. It does not use the city, state, country, and other descriptive information.

### Annual Averages Calculated from Weather File

When you add a weather file to the solar resource library, SAM reads weather data from the file and calculates the annual averages to display for your reference. It does not use annual averages during simulations.

#### Global horizontal, Direct normal (beam), Diffuse horizontal

The sum of solar irradiance data (W/m<sup>2</sup>) in the weather file converted to kW and divided by 365 days/year.

#### Average temperature

The sum of temperature data (°C) in the weather file divided by the number of records in the file (8760 for hourly data).

#### Average wind speed

The sum of wind speed data (m/s) in the weather file divided by the number of records in the file (8760 for hourly data).



### Maximum snow depth

The maximum value of snow depth data (cm) in the weather file. **NaN** indicates the file does not contain snow depth data.

## 16.2 Feedstock

The Feedstock page inputs define the biomass resource of the location you specify on the [Ambient Conditions](#) page, and the physical content of the resource.

For a technical description of the biopower model, see Jorgenson, J.; Gilman, P.; Dobos, A. (2011). Technical Manual for the SAM Biomass Power Generation Model. 40 pp.; NREL Report No. TP-6A20-52688. <http://www.nrel.gov/docs/fy11osti/52688.pdf>

You can use any combination of the following options to specify the feedstock:

- Download feedstock data from the NREL Biofuels Atlas (<http://maps.nrel.gov/biomass>) to determine the feedstock available for common agricultural and wood residues at the location you specify on the [Location and Ambient Conditions](#) page.
- Specify feedstock availability, obtainability, and moisture content by hand.
- Specify elemental composition and heating values for up to two user-specified feedstocks.
- Specify properties of a supplemental coal feedstock.

### Biomass Feedstock Resource

Describes the amount of biomass available as an energy resource within a certain radius of a the location specified on the [Location and Ambient Conditions](#) page.

#### Collection radius, miles

The collection radius defines a circle with the location specified on the Location and Ambient Conditions page at its center.

Increasing the collection radius increases the amount of available biomass, but also causes the distance-dependent feedstock delivery costs (specified on the [Feedstock Costs](#) page) to increase. Generally, a collection radius of greater than 50 miles is unrealistic.

#### Resource Available

Quantity of each resource available in bone dry tons/year.

#### Resource Obtainability

The obtainability percentages apply to the quantities under **Resource Available** to define the obtainable resource.

**Note.** The available resource data from the NREL Biofuels Atlas assume that a certain amount of harvest residue remains on the field to prevent soil erosion and maintain nutrients. The resource obtainability percentages apply to the portion of the residue that does not remain on the field.

#### Moisture (wet %)

The average annual wet moisture content of the crop or wood residue as collected.

SAM uses the wet basis moisture ( $M_{wb}$ ), which is the ratio of the weight of water to the weight of the wet biomass weight.

Biomass moisture can also be quantified using the dry basis moisture ( $M_{db}$ ), which is the ratio of the weight of water to the dry biomass weight. The following equations show the relationship between the two moisture content quantities:

$$M_{wb} = M_{db} \div (1 + M_{db})$$

$$M_{db} = M_{wb} \div (1 - M_{wb})$$

## Traditional Residues

Traditional residues generally fall into two categories: field residue and process residue.

- Bagasse is a residue that is product of sugarcane and sorghum processing.
- Barley straw, corn stover, rice straw, and wheat straw are all field residues that remain after harvest.
- Forest residues usually refer to lumber that is unfit for sawmill processing, such as smaller-diameter branches or stumps, misshapen trees, and undergrowth that may fuel forest fires.
- Primary mill residues are wastes generated by mill processes.
- Urban wood waste includes prunings from residential areas, as well as woody construction materials and used pallets.

## Dedicated Energy Crops

Dedicated energy crops are grown specifically for use as a fuel. These crops typically have high yields and densities per acre.

- Woody crops are trees such as willow and poplar.
- Herbaceous crops are grasses such as miscanthus and switchgrass.

## User-Specified Biomass Feedstocks

You can specify up to two custom feedstocks for biomass resource for locations with biomass resources not listed under **Traditional Residues** and **Dedicated Energy Crops**.

### Specify Additional Feedstocks

Check the box to specify custom feedstocks.

### Feedstock Resource

The annual total obtainable resource quantity in dry tons per year.

### Moisture Content (% wet basis)

The average annual wet moisture content of the crop or wood residue as collected.

SAM uses the wet basis moisture ( $M_{wb}$ ), which is the ratio of the weight of water to the weight of the wet biomass weight. See above for equations relating the wet and dry moisture content.

### Input dry higher heating value (HHV)

Choose this option to specify the feedstock's higher heating value in Btu per dry pound.

### Calculate HHV based on elemental composition

Choose this option to have SAM calculate a higher heating value based on the elemental composition values you specify.

**Carbon content (wt %)**

The mass percent carbon content of the feedstock.

This value is used for defining the combustion reaction and determining the higher heating value.

For biomass, typical carbon content is around 45%-50%. For coal, the carbon content may be as high as 75%-80%.

**Hydrogen content (wt %)**

The mass percent hydrogen content of the feedstock.

SAM uses the hydrogen content in combustion calculations, and to determine the latent heat loss when hydrogen in the sample is combusted.

Hydrogen content for most solid fuels is 5%-6%.

**Nitrogen content (wt %)**

The mass percent nitrogen content of the feedstock.

The typical nitrogen content for some biomass and coal can be up to 2%. Many biomass types can be as low as 0.1% nitrogen.

**Supplemental Coal Feedstock**

In some cases, you may be interested in comparing the performance of biomass feedstocks to traditional fossil fuels. Alternatively, for regions of scarce or costly biomass feedstocks, coal may be used to augment plant capacity.

SAM determines whether a plant is co-fired based on the resource availability quantities you specify. If you specify zero for all of the biomass feedstocks, SAM will model the plant as a coal-fired plant with no biomass.

For co-fired plants, SAM assumes direct co-firing, where coal and biomass are fed to the same boiler.

**Use a coal feedstock to augment plant capacity**

Check this box to model a plant with coal.

To model a coal-only plant, change all of the biomass feedstock availability values to zero.

**Bituminous Coal Resource**

Bituminous coal is the most prevalent rank of coal in the United States. It has a high heat content and is found mostly in the eastern US.

**Sub-bituminous Coal Resource**

Sub-bituminous coal has a slightly lower heat content than bituminous coal and is most commonly mined in Wyoming.

**Lignite Coal**

Lignite coal is the cheapest and lowest quality rank of coal. Lignite coal mining occurs primarily in Texas and North Dakota.

**Resource Available**

The annual availability of the coal feedstock in dry tons/year.

**Higher Heating Value (HHV)**

The coal resource higher heating value in Btu/dry pound. The default values are Bituminous = 13272, Sub-bituminous = 10958, and Lignite = 7875.

**Moisture (wet %)**

The wet-basis moisture content of the coal feedstock in percent. The default values are Bituminous = 10, Sub-bituminous = 25, and Lignite = 39.

**Overall Feedstock Characteristics****Total estimated plant capacity with selected feedstock**

The estimated nameplate capacity calculated based on type of biomass, amount of biomass, and performance parameters specified on the [Feedstock](#) and Plant Specs pages. In order to increase the capacity, the biomass supplied on the Feedstock page must be directly increased.

SAM does not use the estimated max gross nameplate capacity value in simulations. It is shown purely for reference. The simulation engine computes the actual efficiency, whereas the estimated nameplate capacity is based on an estimated efficiency. The simulation engine takes into account variations like ambient conditions or the dispatch schedule. To capture this temporality, the simulation engine averages the hourly efficiencies.

**Average HHV and LHV**

SAM calculates and displays the weighted average of the HHV and LHV for each feedstock based the obtainable biomass that you specify. Changing the resource availability or obtainability for one or more feedstock changes the average HHV and LHV values.

Typical heating values for biomass are generally between 7000-8000 Btu/lb (or about 16,000 – 19,000 kJ/kg).

**Wt frac of total feedstock**

The weight of the biomass and coal feedstock as a fraction of the total feedstock weight.

## 16.3 Plant Specs

The Plant Specs page inputs define the major unit operations that make up a biomass power plant: biomass processing, combustion system and boiler, and steam turbine.

For a technical description of the biopower model, see Jorgenson, J.; Gilman, P.; Dobos, A. (2011). Technical Manual for the SAM Biomass Power Generation Model. 40 pp.; NREL Report No. TP-6A20-52688. <http://www.nrel.gov/docs/fy11osti/52688.pdf>

**Biomass Feedstock Handling**

The biopower model has three options for specifying biomass moisture content.

**Fed as received**

The biomass feedstock does not undergo any substantial drying before being fed to the combustor. This option avoids drying costs but penalizes the boiler efficiency since evaporation of biomass moisture requires energy input.

### Allow feedstock to air-dry to atmospheric Equilibrium Moisture Content (EMC)

The biomass is exposed to the ambient atmospheric conditions for a sufficient amount of time to reach EMC. However, moisture composition doesn't change instantly, and thus the equilibrium moisture levels are calculated on a monthly basis.

### Dry to specified moisture content

The feedstock handling system includes a dryer as an additional capital expenditure that you specify on the [Biopower System Cost](#) page. Adding a dryer also increases the parasitic load of the plant and may add an incremental operation and maintenance cost. Although adding a dryer can increase the boiler efficiency by several percent, dryers are not widely used in practice because of the additional costs and parasitic loads.

## Combustion System

SAM can model three common combustion systems encountered in biomass power plants. For a more detailed description of the combustion systems with suggestions for choosing input values, see Section 3.1.2 of the SAM biomass power technical manual referenced at the top of this page.

### Grate Stoker Furnace

A grate stoker furnace is designed to feed solid fuel onto a grate where burning occurs, with combustion air passing through the grate. Stokers are generally the least expensive of the three boiler types and are best suited for large fuel feed rates, typically between 75,000 lb/hr and 700,000 lb/hr.

### Fluidized Bed Combustor (FBC)

Fluidized bed combustion features a bed of fuel and sand or other inert substance that becomes suspended by the combustion air flowing upward. This technology reduces the fluctuations in steam production associated with changeable feedstocks, and features a lower combustion temperature and reduced formation of pollutants. However, capital costs and O&M costs are typically higher for the FBC than the other combustion systems.

### Cyclone Furnace

Cyclone furnaces allow for flexibility in fuel types and increase combustion efficiency over stoker boilers by feeding the fuel in a spiral manner. Additionally, cyclone furnaces are smaller and have a lower capital cost than FBCs.

**Note.** SAM does not automatically change the cost assumptions on the Biopower System Cost page when you change the combustion system option. Be sure to use costs appropriate for the type of plant you specify.

## Boiler Parameters

You can specify the main parameters that determine boiler and furnace efficiency.

**Note.** The values of the parameters depend on the type of combustor. The default values are for a boiler for a steam grade of 900 F, 900 psig. If you choose a different steam grade, be sure to change the value of the other parameters accordingly.

### Steam Grade

The severity of the steam grade is often determined by the type of boiler. For example, lower combustion temperatures in fluidized bed combustors often result in lower steam grades. The steam grade directly determines the enthalpy of the steam produced in the boiler.

**Percent excess fed air, %**

By convention, the percent excess air is specified on a volumetric/molar basis. Combustion air from the atmosphere is only 21% oxygen by volume (and the balance nitrogen). Therefore, most of the enthalpy losses result from heating the nitrogen that accompanies the combustion oxygen. Increasing the excess fed air percentage decreases the boiler efficiency because more energy is required to heat the combustion air. If the excess air fed air percentage is too low, the fuel will not combust fully and the boiler can emit carbon monoxide and smoke.

**Number of boilers**

Using fewer boilers reduces installation costs. Using more boilers may also reduce costs by offering the benefit of economies of scale. Typically, small utility scale-sized biopower plants use between one and three boilers.

**Flue gas temperature, °F**

The flue gas is the mixture of gases exiting the plant through the stack. All useable heat has been collected when the combustion gases reach the specified flue gas temperature. Flue gas heat is often used to preheat other process streams, such as the boiler feedwater. The most efficient boilers utilize as much of the flue gas heat as possible before it exits the plant.

**Estimated steam produced, lb/hr steam**

This metric is calculated based on the estimated efficiency of the boiler and the enthalpy of the steam produced. The steam produced in the boiler directly powers the steam turbine.

**Boiler oversize factor, %**

Boilers are generally oversized to prevent operating above capacity and for the ability to accommodate more biomass throughput. A higher value increases the boiler capital cost. Too low of a value results in lower overall efficiency.

**Design capacity of each boiler, lb/hr steam**

Boilers are generally oversized to accommodate fluctuations in steam production and to allow for additional capacity. However, highly oversized boilers can result in increased efficiency loss and capital cost. The boiler oversize factor input will directly adjust the design capacity of each boiler metric.

**Estimated Efficiency Losses (HHV)****Dry flue gas losses, %**

Combustion air enters the furnace at ambient temperature, where it is immediately subject to preheating by waste process heat. Regardless of how the air is preheated, a significant loss of enthalpy occurs when the combustion gas exits the plant at a much higher temperature than the temperature at which it was fed. The Dry Flue Gas Loss is largely determined by the input percent excess fed air. Combustion air from the atmosphere is only 21% oxygen by volume (and the balance nitrogen). Thus, much of the enthalpy losses result from heating up the nitrogen that accompanies the combustion oxygen.

**Moisture in flue, %**

Moisture in fuel adversely affects plant efficiency in two primary ways. First, water in biomass imposes extra mass that must be consequently hauled and processed with the biomass itself. Additionally, the water absorbs heat from the combustion reaction that is unlikely to be recovered. Some power plants employ pre-combustion biomass drying to reduce moisture content and efficiency loss in this category. SAM allows the user to add a dryer under the dry to specified moisture content input on the Plant Specs page.

**Latent heat, %**

Loss of latent heat results when elemental hydrogen in biomass combusts to form water. The water produced will leave the stack at the flue gas temperature as water vapor, thus requiring the latent heat of vaporization of water as well as the sensible heat of the vapor at the flue gas temperature.

**Unburned fuel, %**

Unburned fuel losses simply result from incomplete combustion in the boiler. In practice, the unburned fuel percentage depends on the type of boiler and excess fed air. This efficiency loss is one of the most difficult to predict, but for well-maintained boilers at proper levels of excess air, the degree of incomplete combustion should be similar among various technologies. Therefore, the boiler type input will determine this value.

**Radiation and miscellaneous, %**

This category encompasses radiation losses and various other losses that are difficult to quantify or predict, such as moisture in air, sensible heat in ash, and radiation in ash pit. The other derates are lumped together under a "manufacturer's margin" derate, which is taken to be 2.03%. For more information about this category, consult the Technical Manual.

**Total Boiler Efficiency (HHV Basis), %**

$$\text{Total Boiler Efficiency} = 100 - \text{Dry Flue Gas Losses} - \text{Moisture in Fuel} - \text{Latent Heat} - \text{Unburned Fuel} - \text{Radiation and Miscellaneous}$$

**Steam Rankine Cycle**

Steam produced in the boiler at the specified grade drives a steam turbine and electric generator to convert the thermal energy of the steam to electricity.

**Note.** The biomass power's steam turbine model is based on the empirical parabolic trough model's power block model. For a description of how SAM uses the part-load and temperature adjustment coefficients, see [Power Block Simulation Calculations](#).

**Estimated max gross nameplate capacity, kW**

The estimated nameplate capacity calculated based on type of biomass, amount of biomass, and performance parameters specified on the [Feedstock](#) and Plant Specs pages. In order to increase the capacity, the biomass supplied on the Feedstock page must be directly increased.

SAM does not use the estimated max gross nameplate capacity value in simulations. It is shown purely for reference. The simulation engine computes the actual efficiency, whereas the estimated nameplate capacity is based on an estimated efficiency. The simulation engine takes into account variations like ambient conditions or the dispatch schedule. To capture this temporality, the simulation engine averages the hourly efficiencies.

**Rated cycle conversion efficiency**

The rated efficiency of the turbine, equivalent to average conversion efficiency of the steam's thermal energy to electricity.

**Minimum load**

Most turbines do not operate below a certain fraction of full load, when the turbine performance is difficult to predict and the economics may become unfavorable. The fractional value for minimum load represents the threshold below which the turbine will not operate.

**Max oversize operation**

Prevents the turbine from operating above a certain fraction of the design load.

**Power cycle design temperature, °F**

The design temperature of the turbine. The actual efficiency of the turbine is temperature dependent. Fluctuations of the temperature cause changes in the efficiency.

**Part Load and Temperature Efficiency Adjustments**

The effect of temperature and part load on efficiency can be adjusted with the coefficients F0 – F4. These coefficients define a polynomial equation for adjusting the amount of heat supplied to the power block based on deviations from full load and design temperature.

**Temperature Correction Mode**

Choose either an air-cooled condenser (dry bulb) or evaporative cooling (wet bulb).

Dry-bulb temperature refers to the thermodynamic temperature of the air that can be found with a standard thermometer. The wet-bulb temperature also captures the moisture content of the air, and is always less than the dry-bulb temperature (except at 100% relative humidity, when the two are equal).

Evaporative cooling uses the evaporation of water to cool the process condensate to near the wet-bulb temperature. Dry cooling uses air and thus the minimum heat rejection is the dry-bulb temperature.

Typically, air-cooled systems require more capital, are less thermodynamically efficient, and use more energy. However, evaporative cooling demands more water and might not be suitable in some regions.

**System Availability**

System availability losses are reductions in the system's output due to operational requirements such as maintenance down time or other situations that prevent the system from operating as designed.

**Note.** To model curtailment, or forced outages or reduction in power output required by the grid operator, use the inputs on the [Grid Limits](#) page.

To edit the system availability losses, click **Edit losses**.

The [Edit Losses](#) window allows you to define loss factors as follows:

- Constant loss is a single loss factor that applies to the system's entire output. You can use this to model an availability factor.
- Hourly losses apply to specific hours of the year.

SAM reduces the system's output in each hour by the loss percentage that you specify for that hour. For a given hour, a loss of zero would result in no adjustment. A loss of 5% would reduce the output by 5%, and a loss of -5% would increase the output value by 5%. For subhourly simulations, SAM applies the loss factor for a given hour to each time step in that hour

**Parasitics****Parasitic load (% of nameplate), %**

The electric load requirement as a percentage of the nameplate capacity for plant loads such as pumps, compressors, fans, lighting, etc.

**Total plant parasitic load, kWe**

$$\text{Total Plant Parasitic Load (kW)} = \text{Parasitic Load (\% of Nameplate)} \div 100 \times \text{Estimated Max Gross Nameplate Capacity (kW)}$$



## Time of Dispatch Schedule

The Time of Dispatch controls allow you to specify at what times the plant operates, and at what fraction of its nameplate capacity.

If you want the plant to operate at its full capacity at all times, do not check **Enable Time of Dispatch Schedule**.

Check **Enable Time of Dispatch Schedule** to specify fractional generation levels for up to nine periods. For each period, you can specify a fraction of the nameplate capacity.

Use your mouse to select blocks of hours in the schedule matrix and type a period number to specify the hours of each month that the period applies. For example, to specify the hours for Period 2, use your mouse to select a block of hours, and then type the number 2. See the [Weekday-weekend Schedule](#) reference topic for step-by-step instructions for using assigning periods to a schedule matrix.

You can use the dispatch schedule to model:

- Scheduled seasonal outages by specifying a fraction of zero for times when the plant will be down.
- Periods of high demand when the plant can operate above its nameplate capacity, for example during summer months.

**Note.** If you specify a Fractional Generation value greater than the Max Over Design Operation value, the simulation will fail.

- Periods of feedstock shortages and surpluses when the plant is forced to operate below or above capacity.

## Ramp Rate

SAM provides three options for specifying the ramp rate, or the rate at which a plant can increase or decrease its generation.

### Do not specify ramp rate

Assumes that the plant can operate at the fraction of nameplate capacity in each hour that the fraction applies. This option is appropriate when the ramp rate is less than SAM's hourly simulation time step, or when you model the ramp rate explicitly using a series of ramp rates over a period of hours.

### Specify ramp rate in kW per hour

Model the ramp rate as an energy requirement as a kW per hour value during periods when the plant operates at a fraction of the nameplate capacity.

### Specify ramp rate in percent of capacity per hour

Model the ramp rate as an energy requirement as a percentage of the nameplate capacity during periods when the plant operates at a fraction of the nameplate capacity.

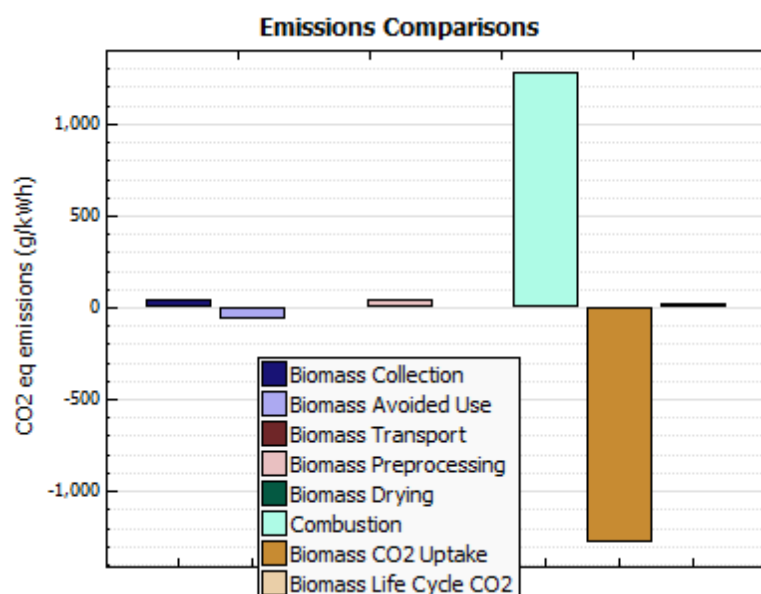
## 16.4 Emissions

The Life-Cycle Impacts page allows you to specify inputs for a set of life-cycle greenhouse gas emissions calculations for the biomass supply chain. You can use these inputs to estimate the independent contributions of biomass collection, transport, pre-processing, combustion, and CO<sub>2</sub> re-uptake on the life-cycle carbon dioxide emissions of the project.

For a technical description of the biopower model, see Jorgenson, J.; Gilman, P.; Dobos, A. (2011). Technical Manual for the SAM Biomass Power Generation Model. 40 pp.; NREL Report No. TP-6A20-52688. <http://www.nrel.gov/docs/fy11osti/52688.pdf>

**Note.** The life-cycle impacts calculations are independent of the power plant energy modeling calculations. The inputs on the life-cycle impacts page are for a separate set of calculations than the inputs on the [Feedstock](#) and [Plant Specs](#) pages.

After running the simulation, SAM displays a graph on the [Results](#) page similar to the following one showing the percent difference in CO<sub>2</sub> equivalent emissions from the different sources.



### Inside farmgate

#### Diesel-powered biomass collection vehicle / Biodiesel-powered biomass collection vehicle

Specifies the type of fuel used to power the field biomass collection vehicle. Please note that this input only affects the life-cycle analysis portion of the model.

#### Assume biomass was not grown dedicated to power (waste)

Specifies the intended use of the biomass. When waste biomass goes unused (e.g., in a landfill), it undergoes decomposition which can result in methane emissions. If a biopower plant utilizes biomass that would otherwise decompose, the plant receives a greenhouse gas "credit" for avoiding more harmful methane emissions.

Clearing this box signifies that the biomass was grown explicitly for power generation, meaning that no decomposition emissions were avoided.

## From farmgate to biopower facility

### **Diesel-powered vehicle for truck transport / Biodiesel-powered vehicle for truck transport**

This input specifies the type of fuel used to power the vehicle used to haul the biomass from the farmgate to the biopower facility. Please note that this input only affects the life-cycle analysis portion of the model. For instance, if using biodiesel increases the delivery cost of biomass, you must reflect the increased cost on the [Feedstock Costs](#) page.

### **One-stage truck transport (no separate pre-processing facility) / Two-stage truck transport (separate pre-processing facility)**

Occasionally, regional biomass will be pre-processed at a separate facility before being used in a biopower plant. This input

considers the vehicle-miles traveled for biomass to arrive at the biopower plant. For instance, the vehicle-miles traveled may increase if the biomass must travel to a pre-processing facility that is not on the way to the plant. Again, please note that this input only affects the life-cycle analysis portion of the model.

### **Enable long-distance transport after xx miles: Freight rail transport for long distances / Freight barge transport for long distances**

Currently, most biomass is transported via truck for short distances. However, after a certain amount of miles, rail or barge transport may become more economical. This option allows you to see the emissions benefits of using a more efficient transport option for a specified "longer" distance. Again, please note that this input only affects the life-cycle analysis portion of the model. For instance, if using railroad transport decreases the delivery cost of biomass, you must reflect the changed cost on the [Feedstock Costs](#) page.

## Preprocessing Options

### **Pre-processing includes grinding or chipping / Pre-processing includes pelletization**

Most biomass typically undergoes some pre-processing before being fed into a biopower plant. The pre-processing may include light grinding or chipping, heavy grinding, and/or pelletization. In most cases each pre-processing step would be subsequent to the previous step. For example, biomass pelletization only occurs after heavy grinding.

Pre-processing increases the resources required to prepare the biomass and thus increase the emissions impact of biomass power

## Electricity grid carbon intensity, g CO<sub>2</sub> eq/kWh

This input allows you to specify the carbon intensity of the electricity being used for pre-processing, fertilizer production, and biomass storage.

For example, if a carbon-efficient technology is used to generate the power required for pre-processing, the overall greenhouse burden of the biopower facility would be less than a less efficient technology.

You can choose from several US regional values with sample values for 100% coal and 100% renewable energy. The default value is the 2010 United States average.

## 16.5 System Costs

SAM uses the variables on the Biopower System Costs page to calculate the project investment cost and annual operating costs reported in the project cash flow and used to calculate cost metrics reported in the Metrics table on the Results page.

### Notes.

The default cost values that appear when you create a file or case are intended to illustrate SAM's use. The cost data are meant to be realistic, but not to represent actual costs for a specific project. For more information and a list of online resources for cost data, see the technology pages on the [SAM website](#).

The System Costs page only available for cases with a cash-flow-based financial model. It is not available with the No Financial Model option or the LCOE Calculator financial model.

Because only the **Total Installed Cost** value affects the cash flow calculations, you can assign capital costs to the different cost categories in whatever way makes sense for your analysis. For example, you could assign the cost of designing the power plant to the direct plant cost category or to the engineer-procure-construct category with equivalent results. The categories are provided to help you keep track of the different costs, but do not affect the economic calculations. After assigning costs to the categories, verify that the total installed costs value is what you expect.

Variable values in boxes with white backgrounds are values that you can edit. Boxes with blue backgrounds contain calculated values or values from other pages that SAM displays for your information.

### Direct Capital Costs

A direct capital cost represents an expense for a specific piece of equipment or installation service that applies in year zero of the cash flow. Below are the major unit operations that contribute to the Total Direct Capital Cost calculation, and the appropriate units. Based on earlier inputs, SAM calculates the capacity of each item.

#### Boiler(s)

A cost per lb/hr steam

#### Turbine & Generator

A cost per kW of gross nameplate capacity to account for turbine and generator installation costs.

#### Fuel Handling Equipment

A cost per kW of gross nameplate capacity to account for fuel handling equipment costs.

#### Dryer

A cost per kW of gross nameplate capacity to account for feedstock drying equipment. This cost is only available when you choose **Dry to Specified Moisture Content** as the Biomass Feedstock Handling option on the [Plant Specs](#) page.

#### Other Equipment

A cost per kW of gross nameplate capacity to account for equipment not included in the categories above.

**Balance of Plant**

A cost per kW of gross nameplate capacity to account for plant-related costs not associated with specific components of the plant.

**Contingency**

A percentage of the sum of the above costs to account for expected uncertainties in direct cost estimates.

**Total Direct Capital Cost (\$)**

The sum of the direct capital costs, including contingency costs.

**Indirect Capital Costs**

An indirect cost is typically one that cannot be identified with a specific piece of equipment or installation service.

**Engineer, Procure, Construct (% and \$)**

Engineer-Procure-Construct costs, sometimes abbreviated as EPC costs, are costs associated with the design and construction of the project, which SAM calculates as the sum of a “non-fixed cost” and with a fixed cost.

**Project, Land, Miscellaneous (% and \$)**

Project-Land-Miscellaneous costs are those associated with the purchase and preparation of land, and other indirect costs not included in the EPC category.

**% of Direct Cost**

A value that you type as a percentage of **Total Direct Capital Cost** (under **Direct Capital Costs**)

**Non-fixed Cost**

A value that SAM calculates as the product of **% of Direct Cost** and **Total Direct Capital Cost**.

**Fixed Cost**

A value that you type as a fixed amount in dollars.

**Total**

A value that SAM calculates as the sum of **Non-fixed Cost** and **Fixed Cost**.

**Sales Tax (%)****Sales tax basis, %**

The percentage of total direct cost used to the calculate sales tax amount.

SAM calculates the total sales tax amount by multiplying the sales tax rate from the [Financial Parameters](#) page by the sales tax basis on the System Costs page:

$$\text{Total Sales Tax (\$)} = \text{Sales Tax Rate (\%)} \times \text{Sales Tax Basis (\%)} \times \text{Total Direct Cost (\$)}$$

For an explanation of the effect of sales tax on income tax, see **Sales Tax** on the [Financial Parameters](#) topic for the financial model you are using (Residential, Commercial, Single Owner, etc.)

**Total Indirect Cost (\$)**

The sum of engineer-procure-construct costs, project-land-miscellaneous costs, and sales tax.

## Total Installed Cost

The total installed cost is the sum of all of the direct and indirect capital costs that you specify. SAM uses this value to calculate the project's [net capital cost](#), which is the total installed cost less any cash incentives on the [Incentives](#) page and plus any additional financing costs from [Financial Parameters](#) page.

### Total installed cost (\$)

The sum of total direct cost and total indirect cost.

### Total installed cost per capacity (\$/Wdc or \$/kW)

Total installed cost divided by the total system rated or nameplate capacity. This value is provided for reference only. SAM does not use it in cash flow calculations.

## Operation and Maintenance Costs

Operation and Maintenance (O&M) costs represent annual expenditures on equipment and services that occur after the system is installed. SAM allows you to enter O&M costs in three ways: Fixed annual, fixed by capacity, and variable by generation. O&M costs are reported on the project [cash flow](#) in Years 1 and later..

For each O&M cost category, you can specify an optional annual **Escalation Rate** to represent an expected annual increase in O&M cost above the annual inflation rate specified on the [Financial Parameters](#) page. For an escalation rate of zero, the O&M cost in years two and later is the year one cost adjusted for inflation. For a non-zero escalation rate, the O&M cost in years two and later is the year one cost adjusted for inflation plus escalation.

For expenses such as component replacements that occur in particular years, you can use an annual schedule to assign costs to individual years. See below for details.

### Fixed annual cost (\$/yr)

A fixed annual cost that applied to each year in the project cash flow.

### Fixed cost by capacity (\$/kW-yr)

A fixed annual cost proportional to the system's rated or nameplate capacity.

### Variable cost by generation (\$/MWh)

A variable annual cost proportional to the system's total annual electrical output in AC megawatt-hours. The annual energy output depends on either the performance model's calculated first year value and the **degradation rate** from the [Lifetime](#) page, or on an annual schedule of costs, depending on the option chosen.

For systems with include battery storage:

### Battery replacement cost

The battery replacement cost in Year 1 dollars per kWh of installed battery capacity. SAM uses the inflation rate from the [Financial Parameters](#) page to calculate the replacement cost in the replacement year.

**Note.** To include battery replacements costs in your analysis, be sure to choose a battery replacement option on the [Battery Storage](#) page.

## 16.6 Feedstock Costs

Biomass feedstock costs vary widely over distance, season, geographical location, type, and availability. Additionally, feedstock cost is traditionally a very substantial cost of every kilowatt-hour generated from biopower. The defaults are averages of several recent costs but may not be appropriate for your analysis.

**Note.** The default cost values that appear when you create a file or case are intended to illustrate SAM's use. The cost data are meant to be realistic, but not to represent actual costs for a specific project. For more information and a list of online resources for cost data, see the [SAM website](#).

### Transportation Costs

Transporting biomass differs from transporting fossil fuels in two ways. First of all, biomass has a significantly lower energy density and generally higher moisture contents. Additionally, biomass feedstocks are more distributed than fossil fuels, which are largely collected from extraction points such as mines or wells. Since long-distance biomass transportation is currently unfeasible, most biomass is delivered via diesel trucks. At larger distances, railway transport may become more cost effective.

### Distance-fixed delivery cost

A distance-fixed delivery cost includes expenses incurred that are not dependent on the distance traveled. For example, this category may include the expense associated with the vehicle itself, as well as loading and unloading costs.

### Distance-variable delivery cost

The distance-variable delivery cost is expressed in terms of \$/ton-mi which directly reports the cost of hauling a ton of biomass as harvested for one mile. This could include vehicle maintenance costs and fuel expenditures which directly correlate to miles traveled.

### Feedstock Price (\$/dry ton)

The feedstock price is simply the cost of one ton of dry biomass. Note, the transportation cost is separate.

### Fuel Escalation Rate (%/year)

The anticipated fuel price escalation rate can be specified separately for both biomass and coal feedstocks.

## 17 Generic System

The generic system model allows you to represent a power plant using a simple model based on capacity factor and nameplate capacity, or to import hourly or subhourly electric generation data from another simulation model or measured from an operating system.

You can use the generic system model for the following applications:

- Model a thermal power plant as a baseline case for comparison with renewable alternatives.

- Use energy generation profiles for any type of power system from other software with SAM's financial models.
- Use measured data from an installed plant with SAM's financial models.

## 17.1 Power Plant

The generic system model allows you to represent a power plant using a simple model based on capacity factor and nameplate capacity, or to import hourly or subhourly electric generation data from another simulation model or measured from an operating system.

### Generic System Model

You can use the generic system model for the following applications:

- Model a thermal power plant as a baseline case for comparison with renewable alternatives.
- Use power generation profiles for any type of power system from other software with SAM's financial models.
- Use measured data from an installed plant with SAM's financial models.

### Generic Battery Model

The generic battery model combines the generic system model with the battery storage model from the PV battery model. You can use the generic battery model for:

- A battery system that responds to an hourly or subhourly generation profile from another model or from a performance monitoring program.
- A standalone battery system.

To model a standalone battery system, set the nominal capacity factor to zero (setting the nameplate capacity to zero may cause simulation errors).

After running a simulation, you can see the hourly energy values in the [Tables](#) or [time series graphs](#) on the [Results](#) page.

### Generic Power Plant

The generic system model provides two options for describing the power plant's performance. You can either specify a nameplate capacity and capacity factor to model a constant generation profile, or you can import hourly or subhourly generation data from a file.

#### Constant generation profile from nameplate capacity and capacity factor

Choose this option to model a generation profile that remains constant throughout the day and year. For this option, you provide the nameplate capacity, capacity factor, and loss values as inputs, and SAM calculates a constant generation profile to match.

#### Import hourly or subhourly generation profile from file

Choose this option when you have data describing the system's generation profile to import into SAM.

#### Nameplate Capacity

The system's nameplate electrical capacity in electric kilowatts.



If your analysis involves a financial model, SAM uses the nameplate capacity to calculate any capacity-based costs that you specify in \$/W on the [Generic System Costs](#) page and any capacity-based incentives on the [Incentives](#) page.

It also uses the nameplate capacity to calculate the capacity factor when you import power generation data as input.

### Nominal capacity factor

The nominal capacity factor is the plant capacity factor, not including plant losses or reduction in output due to system availability.

The nominal capacity factor is only available with the Constant Generation Profile option. SAM uses the value to calculate the total annual generation value as described below.

When you import power generation data, SAM calculates the capacity factor a value based on the data and the nameplate capacity you specify.

For the Generic-Battery configuration, to model a standalone battery, set the nominal capacity factor to zero.

**Note.** SAM reports a separate [capacity factor](#) in the results after you run a simulation that reflects plant losses and any reduction in output due to system availability.

### To import generation profile data:

1. Choose **Import hourly or subhourly generation profile from file**.
2. Click **Edit data** to open a window for importing data from a text file for pasting the data from your computer's clipboard.
3. If you are importing subhourly data, click **Change time step** and enter the time step in minutes. For hourly data, the time step should be 60 minutes.
4. Click **Import** to import the data from a text file.

The data must be in a single column with one row for each time step. Each row should contain a value in kW of electricity generated per time step. For example, an hourly data set should contain 8,760 rows of kW values. A 15-minute data set would contain 35,040 rows of kW values.

The first row is reserved for a header, so do not include any electricity generation data in the first row. SAM checks the number of data rows in the file to ensure it is consistent with the time step you specify. For example, for a 60-minute time step, the text file should contain 8761 rows: One row at the top of the file for the header followed by 8760 data rows. A 15-minute data set would contain a total of 35,041 rows.

To paste the data from a text editor, spreadsheet, or other software, copy the data to your clipboard, and then click Paste.
5. Click **OK** to return to the Power Plant page.
6. Type a value for **Nameplate capacity**. This number might be the same as the peak annual generation, or a different value.

## Power Plant Losses

The power plant loss accounts for output reductions caused by inefficiencies in the system, such as from wiring losses or other factors.

### Power plant loss

A percentage applied to the system's output in each time step for both the constant generation and imported data options. For example, a value of 5% would reduce the system output in each time step

by 5%. Set the loss percentage to zero if all losses are accounted for in the nameplate capacity, capacity factor, or imported generation data.

## Calculated Values Based on Input Assumptions

The calculated values are equivalent to the metrics shown on the Results page after a simulation. Use these values to verify that the nameplate capacity and capacity factor are correct, or that data you imported from a file and nameplate capacity are correct.

### Total annual generation

The system's total annual output. If you are using the generic system model with a financial model with a project cash flow, this value is equivalent to the system's output in its first year of operation.

For the constant generation option:

$$\begin{aligned} \text{Total Annual Generation (kWh/year)} &= \text{Nameplate Capacity (kW)} \\ &\times \text{Capacity Factor (\%)} \div 100 \% \\ &\times (1 - \text{Loss (\%)} \div 100\%) \\ &\times 8,760 \text{ hours/year} \end{aligned}$$

For the import generation from file option:

$$\begin{aligned} \text{Total Annual Generation (kWh/year)} &= \text{Sum of kW Values in Profile (kW)} \\ &\times (1 - \text{Loss (\%)} \div 100\%) \\ &\times 8,760 \text{ hours/year} \div \text{Number of time steps in profile} \end{aligned}$$

### Peak annual generation

The system's maximum output in kW over one year. This value is useful for choosing a nameplate capacity when you import generation data from a file. In some cases, it may be appropriate to set the nameplate capacity to the peak generation value, or to one slightly higher or lower depending on the purpose of your analysis.

The peak annual generation is what you predict the system's actual peak output will be, and the nameplate value is a nominal value that SAM uses for \$/kW cost calculations in the financial model.

### Capacity factor after plant loss

The capacity factor, accounting for the reduction in output when you specify a non-zero plant loss percentage. Use this capacity value when you import generation data to verify that the nameplate capacity you enter is reasonable. For example, you might expect a capacity factor greater than 90% for a thermal power plant, about 20% for a photovoltaic system, 40% for a concentrating solar power system, or about 60% for a wind system.

**Note.** The capacity factor after plant loss shown on the Power Plant page accounts for the plant loss, but not for [system availability](#). If you include system availability losses in your analysis, the [capacity factor](#) SAM reports in the results after you run a simulation reflects those losses.

For the constant generation option, the calculated capacity factor depends on the value that you entered for **Capacity Factor**:

$$\begin{aligned} \text{Capacity Factor After Plant Loss (\%)} &= \text{Capacity Factor (\%)} \\ &\times (1 - \text{Loss (\%)} \div 100\%) \end{aligned}$$

For the import generation from file option:

$$\begin{aligned} \text{Capacity Factor After Plant Loss (\%)} &= \text{Total Annual Generation (kWh)} \\ &\div \text{Peak Annual Generation (kW)} \end{aligned}$$

$$\div 8760 \text{ hours/year}$$
$$\times 100\%$$

## Heat Rate for Fuel Cost Calculation

You only need to specify a heat rate if you are using the generic system model for a thermal power plant that consumes a fuel.

### Heat rate

SAM uses the heat rate value to calculate the cost of fuel consumed by the system using a simple conversion of the kWh values you specify for the energy output to equivalent MMBtu of fuel.

$$\text{Fuel Cost (\$/yr)} = \text{Fossil Fuel Cost (\$/MMBtu)} \times \text{Heat Rate (MMBtu/MWhe)} \times \text{Energy (kWh/yr)} \div 1000$$

*(kWh/MWh)*

Where Fossil Fuel Cost is an annual cost in \$/MMBtu that you specify on the [Generic System Costs](#) page, under Operation and Maintenance Costs, and Fuel Cost and Energy are reported on the [Results](#) page.

If you are using the generic plant to represent a system that does not consume fuel, you should change the heat rate value to zero.

### Nominal thermal-to-electric conversion efficiency

SAM calculates and displays the system's thermal to electric conversion efficiency for reference to help you verify that the heat rate you specified is reasonable. SAM does not use this value during the simulation.

$$\text{Thermal-to-electric conversion efficiency} = 100\% \div \text{Heat Rate (MMBtu/MWhe)} \div 0.2931 \text{ (Wh/Btu)}$$

## System Availability

System availability losses are reductions in the system's output due to operational requirements such as maintenance down time or other situations that prevent the system from operating as designed.

**Note.** To model curtailment, or forced outages or reduction in power output required by the grid operator, use the inputs on the [Grid Limits](#) page.

To edit the system availability losses, click **Edit losses**.

The [Edit Losses](#) window allows you to define loss factors as follows:

- Constant loss is a single loss factor that applies to the system's entire output. You can use this to model an availability factor.
- Hourly losses apply to specific hours of the year.

SAM reduces the system's output in each hour by the loss percentage that you specify for that hour. For a given hour, a loss of zero would result in no adjustment. A loss of 5% would reduce the output by 5%, and a loss of -5% would increase the output value by 5%. For subhourly simulations, SAM applies the loss factor for a given hour to each time step in that hour

## 17.2 System Costs

SAM uses the variables on the Generic System Costs page to calculate the project investment cost and annual operating costs reported in the project [cash flow](#) and used to calculate cost metrics reported in the Metrics table on the [Results page](#).

Because only the total installed cost value affects the cash flow calculations, you can assign capital costs to the different cost categories in whatever way makes sense for your analysis. For example, you could assign the cost of designing the power plant to the direct plant cost category or to the engineer-procure-construct category with equivalent results. The categories are provided to help you keep track of the different costs, but do not affect the economic calculations. After assigning costs to the categories, verify that the total installed costs value is what you expect.

Variable values in boxes with white backgrounds are values that you can edit. Boxes with blue backgrounds contain calculated values or values from other pages that SAM displays for your information.

### Notes.

The default cost values that appear when you create a file or case are intended to illustrate SAM's use. The cost data are meant to be realistic, but not to represent actual costs for a specific project. For more information and a list of online resources for cost data, see the technology pages on the [SAM website](#).

The System Costs page only available for cases with a cash-flow-based financial model. It is not available with the No Financial Model option or the LCOE Calculator financial model.

### Direct Capital Costs

A direct capital cost represents an expense for a specific piece of equipment or installation service that applies in year zero of the cash flow.

**Note:** Because SAM uses only the total installed cost value in cash flow calculations, how you distribute costs among the different direct capital cost categories does not affect the final results.

#### Plant Cost (\$)

A fixed dollar amount.

#### Plant cost per capacity (\$/W)

A cost per Watt of nameplate capacity from the [Power Plant](#) page.

If the system includes a battery, you can specify the battery installation cost in \$/kWh of battery capacity, \$/kW of maximum discharge power, or both:

#### Battery cost per capacity (\$/kWh DC)

Battery installation cost in \$/kWh of nominal bank capacity from the Battery Cell and System page.

#### Battery cost per kW (\$/kW DC)

Battery installation cost in \$/kW of maximum charge power from the Battery Cell and System page.

#### Contingency cost (%)

A percentage of the sum of the plant and battery costs to account for expected uncertainties in direct capital cost estimates.

**Total Direct Cost (\$)**

The sum of plant cost, plant cost per capacity, and contingency costs.

**Indirect Capital Costs**

An indirect cost is typically one that cannot be identified with a specific piece of equipment or installation service.

**Note:** Because SAM uses only the total installed cost value in cash flow calculations, how you distribute costs among the different indirect capital cost categories does not affect the final results.

**Engineering and other EPC costs (% and \$)**

Costs associated with the design and construction of the project.

**% of Direct Cost** is a value that you type as a percentage of **Total direct cost** (under **Direct Capital Cost**). SAM displays the equivalent dollar amount.

**\$** is a value that you type as an amount in dollars.

**Permitting and other EPC costs (% and \$)**

Costs associated with land purchases, permitting, and other costs.

**% of Direct Cost** is a value that you type as a percentage of **Total direct cost** (under **Direct Capital Cost**). SAM displays the equivalent dollar amount.

**\$** is a value that you type as a fixed amount in dollars.

**Sales Tax (%)****Sales tax basis, %**

The percentage of total direct cost used to calculate sales tax amount.

SAM calculates the total sales tax amount by multiplying the sales tax rate from the [Financial Parameters](#) page by the sales tax basis on the System Costs page:

$$\text{Total Sales Tax (\$)} = \text{Sales Tax Rate (\%)} \times \text{Sales Tax Basis (\%)} \times \text{Total Direct Cost (\$)}$$

For an explanation of the effect of sales tax on income tax, see **Sales Tax** on the [Financial Parameters](#) topic for the financial model you are using (Residential, Commercial, Single Owner, etc.)

**Total Indirect Cost ( \$)**

The sum of indirect capital costs.

**Total Installed Cost**

The total installed cost is the sum of all of the direct and indirect capital costs that you specify. SAM uses this value to calculate the project's [net capital cost](#), which is the total installed cost less any cash incentives on the [Incentives](#) page and plus any additional financing costs from [Financial Parameters](#) page.

**Total installed cost (\$)**

The sum of total direct cost and total indirect cost.

**Total installed cost per capacity (\$/Wdc or \$/kW)**

Total installed cost divided by the total system rated or nameplate capacity. This value is provided for reference only. SAM does not use it in cash flow calculations.

## Operation and Maintenance Costs

Operation and Maintenance (O&M) costs represent annual expenditures on equipment and services that occur after the system is installed. SAM allows you to enter O&M costs in three ways: Fixed annual, fixed by capacity, and variable by generation. O&M costs are reported on the project [cash flow](#).

For each O&M cost category, you can specify an optional annual **Escalation Rate** to represent an expected annual increase in O&M cost above the annual inflation rate specified on the [Financial Parameters](#) page. For an escalation rate of zero, the O&M cost in years two and later is the year one cost adjusted for inflation. For a non-zero escalation rate, the O&M cost in years two and later is the year one cost adjusted for inflation plus escalation.

For expenses such as component replacements that occur in particular years, you can use an annual schedule to assign costs to individual years. See below for details.

### Fixed Annual Cost (\$/yr)

A fixed annual cost that applied to each year in the project cash flow.

### Fixed Cost by Capacity (\$/kW-yr)

A fixed annual cost proportional to the system's rated or nameplate capacity.

### Variable Cost by Generation (\$/MWh)

A variable annual cost proportional to the system's total annual electrical output in AC megawatt-hours. The annual energy output depends on either the performance model's calculated first year value and the **degradation rate** specified on the [Lifetime](#) page, or on an annual schedule of costs, depending on the option chosen.

### Battery replacement cost (\$/kWh)

If the system includes battery storage, the cost of replacing the battery in the year determined by the battery replacement option you choose on the Battery Storage page.

### Fossil Fuel Cost (\$/MMBtu)

The cost per million British thermal units for fuel. SAM uses the conversion factor 1 MWh = 3.413 MMBtu. The fuel cost only applies to generic system, parabolic trough, and power tower systems. Although the photovoltaic and dish-Stirling models ignore the fuel cost input variable, you should specify a value of zero for the variable to avoid confusion. (When the fossil fill fraction variable on the Thermal Storage page for either of the parabolic trough models or the power tower model is greater than zero, the systems may consume fuel for backup energy.)

## Entering Periodic Operation and Maintenance Costs

SAM allows you to specify any of the four operation and maintenance (O&M) cost categories on the System Costs page either as a single annual cost, or using a table of values to specify an annual schedule of costs. An annual schedule makes it possible to assign costs to particular years in the analysis period. Annual schedules can be used to account for component replacement costs and other periodic costs that do not recur on a regular annual basis.

You choose whether to specify an O&M cost as a single annual value or an annual schedule with the grey and blue button next to each variable. SAM uses the option indicated by the blue highlight on the button: A blue highlighted "Value" indicates a single, regularly occurring annual value. A blue highlighted "Sched" indicates that the value is specified as an annual schedule.

For example, to account for component replacement costs, you can specify the fixed annual cost category as an annual schedule, and assign the cost of replacing or rebuilding the component to particular years. For

a 30-year project using a component with a seven-year life, you would assign a replacement cost to years seven, 14, and 21. Or, to account for expected improvements in the component's reliability in the future, you could assign component replacement costs in years seven, 17, and 27. After running a simulation, you can see the replacement costs in the project [cash flow](#) in the appropriate column under Operating Expenses. SAM accounts for the operating costs in the other economic metrics including the levelized cost of energy and net present value (NPV).

#### Notes.

If you use the annual schedule option to specify equipment replacement costs, SAM does not calculate any residual or salvage value of system components based on the annual schedule. SAM calculates salvage value separately, using the salvage value you specify on the [Financial Parameters](#) page.

Dollar values in the annual schedule are in nominal or current dollars. SAM does not apply inflation and escalation rates to values in annual schedules.

The following procedure describes how to define the fixed annual cost category as an annual schedule. You can use the same procedure for any of the other operation and maintenance cost categories.

#### **To assign component replacement costs to particular years:**

1. In the Fixed Annual Cost category, note that the "Value" label of the grey and blue button is blue indicating that the single value mode is active for the variable.

Fixed Annual Cost   \$/yr

In this case, SAM would assign an annual cost of \$284 to each year in the project cash flow.

2. Click the button so that "Sched" label is highlighted in blue. SAM replaces the variable's value with an Edit button.

3. Click **Edit** to open the [Edit Schedule](#) window.
4. In the Edit Schedule window, use the vertical scroll bar to find the year of the first replacement, and type the replacement cost in current or constant dollars for that year.

To delete a value, select it and press the Delete key on your keyboard.

**Note.** You must type a value for each year. If you delete a value, SAM will clear the cell, and you must type a number in the cell or SAM will consider the schedule to be invalid. Type a zero for years with no annual costs.

5. When you have finished editing the schedule, click **Accept**.

Because you must specify an O&M cost category as either an annual cost or annual schedule, to assign both a recurring annual fixed cost and periodic replacement cost, you must type the recurring cost in each year of the annual schedule, and for years with replacement costs, type the sum of the recurring and replacement costs.

## 18 CSP Parabolic Trough

To model a parabolic trough system, choose either the [physical trough model](#) or the [empirical trough model](#). The physical trough model is suitable for most systems, and the empirical trough is suited for systems with designs similar to the SEGS projects in the southwestern United States.

Both models use the same set of inputs for [location and resource](#) and [system costs](#).

### 18.1 Location and Resource

The Location and Resource page provides access to the solar resource library, which is a collection of weather files stored on your computer. When you first install SAM, it comes with a few default weather files in the library. As you use SAM for your own projects, you should add files to build your own library. Once files are in your library, you can use them for different projects and with different versions of SAM.

The screenshot shows the 'Solar Resource Library' window. At the top, it says 'The Solar Resource library is a list of weather files stored on your computer. You can use the files in the library, or use the tools below to add files to the library.' Below this is a search bar and a table of weather files. A green callout bubble points to the table with the text 'Choose a weather file from the library.' Below the table, there is a list of folders scanned by SAM. A second green callout bubble points to this list with the text 'List of solar resource folders.' To the right of the folder list are two buttons: 'Add/remove weather file folders...' and 'Refresh library'.

Name	Latitude	Longitude	Time zone	Elevation	Station ID
daggett_ca_34.865371_-116.783023_psmv3_60_tmy	34.85	-116.78	-8	561	91486
des_moines_ia_41.586835_-93.624959_psmv3_60_tmy	41.57	-93.62	-6	263	757516
faroo nd 46.9 -96.8 mts1 60 tmy	46.9	-96.8	-6	274	14914

SAM scans the following folders on your computer for valid weather files to add to the solar resource library. To use weather files stored on your computer, add folders containing the files.

- C:\Users\<user>\SAM Downloaded Weather Files
- F:\little\_rock\_ar
- F:\PVGIS 5

Buttons: Add/remove weather file folders..., Refresh library



**Weather Data Information**  
The following information describes the weather file that SAM will use when you click Simulate.

Weather file:

**Header Data from Weather File**

City	-	Station ID	<input type="text" value="91486"/>	Latitude	<input type="text" value="34.85 *N"/>
State	-	Data Source	<input type="text" value="NSRDB"/>	Longitude	<input type="text" value="-116.78 *E"/>
Country	-	Elevation	<input type="text" value="561 m"/>	Time zone	<input type="text" value="GMT -8"/>

**Annual Averages Calculated from Weather File Data**

Global horizontal	<input type="text" value="NaN"/>	kWh/m <sup>2</sup> /day	Average temperature	<input type="text" value="17.3"/>	*C
Direct normal (beam)	<input type="text" value="7.65"/>	kWh/m <sup>2</sup> /day	Average wind speed	<input type="text" value="2.4"/>	m/s
Diffuse horizontal	<input type="text" value="1.27"/>	kWh/m <sup>2</sup> /day	*NaN indicates missing data.		

**Callouts:**

- Weather file for simulation.
- Information from weather file header.
- Summary data calculated from time series data.

There are two ways to add files to your solar resource library:

### 1. Download files from the NREL National Solar Radiation Database (NSRDB)

Use the download weather file options and click **Download and add to library** to get the most up-to-date data from the NSRDB for long-term cash flow analysis, single-year analysis, and P50/P90 analysis.

### 2. Add weather file folders

If you have weather files from a source other than the NSRDB or that you've downloaded yourself directly from the NSRDB website, click **Add/remove weather file folders** to add the folder containing the files to the **Solar Data File Folders** list. SAM automatically adds any weather files it finds in these folders to the solar resource library so they will appear in the list.

When you install SAM, it creates the default download folder *<user>/SAM Downloaded Weather Files* folder where weather files you download from the NSRDB are stored. You can change that folder by clicking **Add/remove weather file folders** and changing the **Folder for Downloaded Solar Data Files**.

For locations not in the NSRDB, you can download weather files in the EPW format from the European Commission Photovoltaic Geographical Information System [PVGIS V5 website](#).

### See also

- [Weather File Formats](#)
- [Weather Data Elements](#)
- [Typical and Single Year](#)
- [Time and Sun Position](#)
- [Folders and Libraries](#)
- [Weather Data and LK](#)

**Notes.**

You may want to model your system using weather data from several different sources and locations around your project site to understand how sensitive your analysis results are to the weather assumptions, and how much variation there is in the data from the different weather files.

You can compare results for a system using more than one weather file in a single case by using SAM's [parametric simulation](#) option.

For more information about weather data, including where to find data for locations outside of the United States, see [Weather Data](#) on the SAM website.

For a helpful discussion of weather data and power system simulation, see Sengupta, M.; Habte, A.; Gueymard, C.; Wilbert, S.; Renne, D.; Stoffel, T. (2017). "Best Practices Handbook for the Collection and Use of Solar Resource Data for Solar Energy Applications: Second Edition." NREL Report No. TP-5D00-68886. ([PDF 8.1 MB](#))

## ▼ Solar Resource Library

SAM's solar resource library displays information from weather files in your solar resource data folders. The default solar resource library that comes with SAM contains weather files for a few locations around the United States for the default configurations. As you use SAM, use **Add/remove weather file folders** to build a library of files for locations you frequently use as described in [Folders and Libraries](#).

### **To choose a file from the solar resource library:**

- Click the location name in the list. You can type a few letters of the file name in the Search box to filter the list.

The full file name and information about the selected file appears under **Weather Data Information**. To see the data in the file, click **View data**.

The screenshot shows the 'Solar Resource Library' window. At the top, it says 'The Solar Resource library is a list of weather files on your computer, or use the tools below to add files to the library.' Below this is a search box. The main area is a table with the following data:

Name	Latitude	Longitude	Time zone	Elevation	Station ID
daggett_ca_34.865371_-116.783023_psmv3_60_tmy	34.85	-116.78	-8	561	91486
des_moines_ia_41.586835_-93.624959_psmv3_60_tmy	41.57	-93.62	-6	263	757516
faroo nd 46.9 -96.8 mts1 60 tmy	46.9	-96.8	-6	274	14914

Below the table, it says 'SAM scans the following folders on your computer for valid weather files to add to the solar resource library. To use weather files stored on your computer, add folders containing the files.' Below this is a list of folders:

- C:\Users\<user>\SAM Downloaded Weather Files
- F:\little\_rock\_ar
- F:\PVGIS 5

At the bottom right, there are two buttons: 'Add/remove weather file folders...' and 'Refresh library'.

### **Add/remove weather file folders**

Use the folder settings to tell SAM what folders on your computer it should scan for weather files to build the solar resource library. SAM adds any files it can identify as valid weather files in each folder you specify to the library.

Before adding a file to the library, SAM checks the data in the file displays a message if it finds any problems with the data in the file.

SAM will only add valid weather files to the library. If you add a folder that contains CSV files that are not in the SAM CSV format, it will not add those files to the library.

The list of solar resource folders are the folders that SAM scans for weather files to build the solar resource library.

### Refresh library

Refresh the library after adding files to the weather file folder. In most cases, SAM should automatically refresh the library as needed, but you may need to manually refresh it.

## Download Weather Files

SAM can download weather files from the latest National Solar Radiation Database (NSRDB) Physical Solar Model (PSM) datasets. For all NSRDB datasets, SAM can download single-year files or typical-year files.

**Download Weather Files**  
Download the latest weather files from the NSRDB to add to your solar resource library: Download a typical-year (TMY) file for most long-term cash flow analyses, or choose files to download for single-year or P50/P90 analyses. See Help for details.

One location     Multiple locations     60-minute     30-minute     Legacy data (advanced)

Type a street address or latitude, longitude (skip for advanced)    Default TMY file    Download and add to library...

[Go to SAM website Weather Page for information about NSRDB and PVGIS, and for links to other sources of solar resource data](#)

**Note.** For locations not in the NSRDB, you can download EPW files from the European Commission Photovoltaic Geographical Information System [PVGIS V5 website](#) to a folder on your computer, and then use the [folder settings window](#) to add the folder to the list of folders SAM scans to build the solar resource library.

### To download a typical-year weather file for a single location:

1. Replace the text "Type a location name, street address or latitude and longitude" with a street address, city and state or country name, zip code, or latitude longitude pair. For example:
  - Golden, Colorado
  - golden, co
  - 15013 Denver West Parkway, Golden CO 80401
  - 80401
  - thimpu, bhutan
2. Click **Download and add to library**.

For more instructions to download multiple files, see [Weather File Download Instructions](#) below.

SAM converts the address you type to a latitude and longitude pair for the location, and submits that information to the NSRDB along with your email address. If the location is in the region covered by the NSRDB, it returns a weather file in the SAM CSV format, and adds it to your weather file download folder. Otherwise, it displays a message telling you the location is not covered by the NSRDB.

When you first install SAM, it creates the *SAM Downloaded Weather Files* folder and assigns it as your weather file download folder. You can change the weather file download folder by clicking **Add/Remove**

**weather file folders.** See [Folders and Libraries](#) for details.

When the download finishes, SAM displays a prompt asking you if you want to open the weather file download log. This prompt is the indication that the download finished. During the download and before that prompt appears, SAM may become unresponsive. If it does, wait for the prompt to avoid interrupting the download.

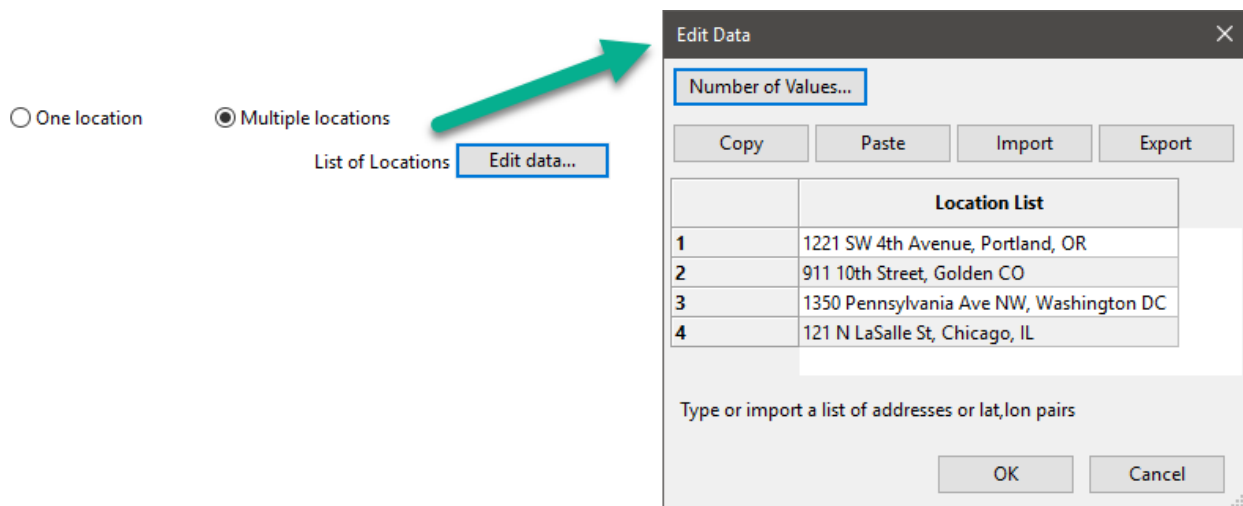
The weather file download log is a text file that SAM creates in your weather file download folder, and serves as a record of all of the files you download from the NSRDB. For each download, it lists the date and time of the request, the information you provided, the URL SAM generated, the name of the file returned by the NSRDB, or error messages it returns if the download fails. This information is useful for troubleshooting weather file download problems.

**Note.** Downloading multiple weather files from the NSRDB can take a long time. If you download files for multiple locations or years, be prepared to wait for the files to download. The download log file reports the time it takes for each file to download. Download times depend on your internet connection and computer. For a new computer with a fast connection, downloading and processing a single file takes about 10 seconds.

### One location, Multiple locations

Choose **One location** to download a weather file for a single location.

Choose **Multiple locations** to submit a list of locations and download a file or files for each location. For Multiple locations, click **Edit data** to open the Edit Data window where you can enter the list of locations and click **Number of Values** to enter the number of locations in the list.

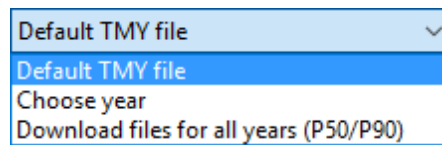


### 60-minute, 30-minute

Choose **60-minute** to download weather files with hourly time steps or 8,760 data records.

Choose **30-minute** to download files with 30-minute time steps or 17,520 data records. Thirty-minute data is not available for the NSRDB SUNY International dataset.

## Download options



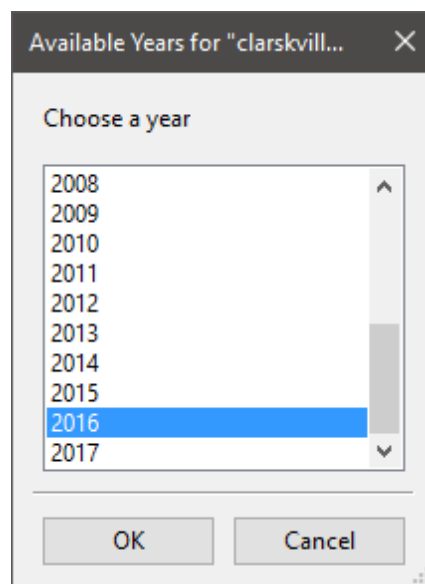
### Default TMY file

Download a typical meteorological year weather file for the location or locations you specified.

Typical year data is appropriate when you are using simulation results for a single year to make cash flow calculations over a multi-year period.

### Choose year

Choose a single year file to download. After you click the Download button, SAM prompts you with a list of available years for each location you requested to choose a year.



The single year option is appropriate when you want to see how the system would perform in a particular year. For example, for a residential or commercial system, if you have measured building load data for a given year, you could use weather data for the same year to see how the system's power output compares to the load.

If you use both **Choose year** and **Multiple locations**, SAM prompts you for a year for each location.

SAM queries the NSRDB to generate the list of available years. The list of available years varies between regions.

### Download files for all years (P50/P90)

Download a set of single-year files covering the range of historical data (nineteen files for 1998 through 2017 as of October 2018 for PSM data). When you click download, SAM creates a folder in your weather file download folder to store the single year files based on the location address or latitude-longitude pair you typed. It also downloads the typical meteorological year (TMY) file for the location and stores it in your weather file download folder.

SAM appends an underscore with the year to the file name so that the P50 P90 simulations work

correctly. See [P50/P90 Simulations](#) for details.

If you choose to download files for all years with **Multiple locations**, SAM downloads a set of files for each location, and puts the files for each location in a separate folder. Note that this may take a long time.

## Weather File Download Instructions

### Examples of valid street address or latitude-longitude pairs:

- golden colorado
- golden, co
- 15013 Denver West Parkway, Golden CO 80401
- 80401
- 39.75, -105.15
- Super Market, F-6 Markaz, Islamabad, Pakistan
- New Delhi, India

**Note.** When the download finishes, SAM displays a prompt asking you if you want to open the weather file download log. This prompt is the indication that the download finished. During the download and before that prompt appears, SAM may become unresponsive. If it does, wait for the prompt to avoid interrupting the download.

### To download an hourly typical-year (TMY) weather file from the NSRDB (use this option for most situations):

1. Click **One location**.
2. Type either a street address or latitude-longitude pair.
3. Click **60-minute**.
4. Choose **Default TMY File**.
5. Click **Download and add to library**.

### To download files for more than one location:

1. Click **Multiple locations**.
2. Click **Edit data**.
3. In the Edit Data window, click **Number of Values** and type the number of locations to create a table with a row for each location.
4. Type a street address or latitude-longitude pair in the table for each location.
5. Click **OK**.
6. Choose a time step, **60-minute** for hourly, or **30-minute** for 30-minute data.
7. Choose the type of file(s) you want to download as described below.
8. Click **Download and add to library**.

## Weather Data Information

**Weather Data Information**  
The following information describes the weather file in the Solar Resource library above. This is the file SAM will use when you click Simulate.

Weather file:  [View data](#)

**-Header Data from Weather File-**

City	<input type="text" value="-"/>	Station ID	<input type="text" value="91486"/>	Latitude	<input type="text" value="34.85 *N"/>
State	<input type="text" value="-"/>	Data Source	<input type="text" value="NSRDB"/>	Longitude	<input type="text" value="-116.78 *E"/>
Country	<input type="text" value="-"/>	Elevation	<input type="text" value="561 m"/>	Time zone	<input type="text" value="GMT -8"/>

**-Annual Averages Calculated from Weather File Data-**

Global horizontal	<input type="text" value="NaN"/>	kWh/m <sup>2</sup> /day	Average temperature	<input type="text" value="17.3"/>	°C
Direct normal (beam)	<input type="text" value="7.65"/>	kWh/m <sup>2</sup> /day	Average wind speed	<input type="text" value="2.4"/>	m/s
Diffuse horizontal	<input type="text" value="1.27"/>	kWh/m <sup>2</sup> /day	*NaN indicates missing data.		

### Weather File

The path and name of the active weather file SAM will use for simulation. Download a different file from the NSRDB, or click a different file name in the library to change the file.

### View data

Display weather file data in the [time series data viewer](#).

**Note.** You can also see the data after running a simulation on the Results page [data tables](#) and [time series graphs](#).

### Header Data from Weather File

Header data is information in the weather file that describes the location and type of data in the file. SAM uses the time zone, elevation, latitude and longitude to calculate the sun position during simulations. It does not use the city, state, country, and other descriptive information.

### Annual Values Calculated from Weather File

When you add a weather file to the solar resource library, SAM reads weather data from the file and calculates the annual values to display for your reference. It does not use annual values during simulations.

#### Global horizontal, Direct normal (beam), Diffuse horizontal

The sum of solar irradiance data (W/m<sup>2</sup>) in the weather file converted to kW and divided by 365 days/year.

#### Average temperature

The sum of temperature data (°C) in the weather file divided by the number of records in the file (8760 for hourly data).

#### Average wind speed

The sum of wind speed data (m/s) in the weather file divided by the number of records in the file (8760 for hourly data).

### Maximum snow depth

If the weather file contains snow depth data, the maximum value of snow depth data (cm) in the weather file. NaN indicates the file does not contain snow depth data. Snow depth data is required for to model snow losses for the Detailed Photovoltaic and PVWatts models.

**Note.** For information about where to find weather files with snow depth data, see the note on the [Weather Data](#) page of the SAM website.

### Annual albedo

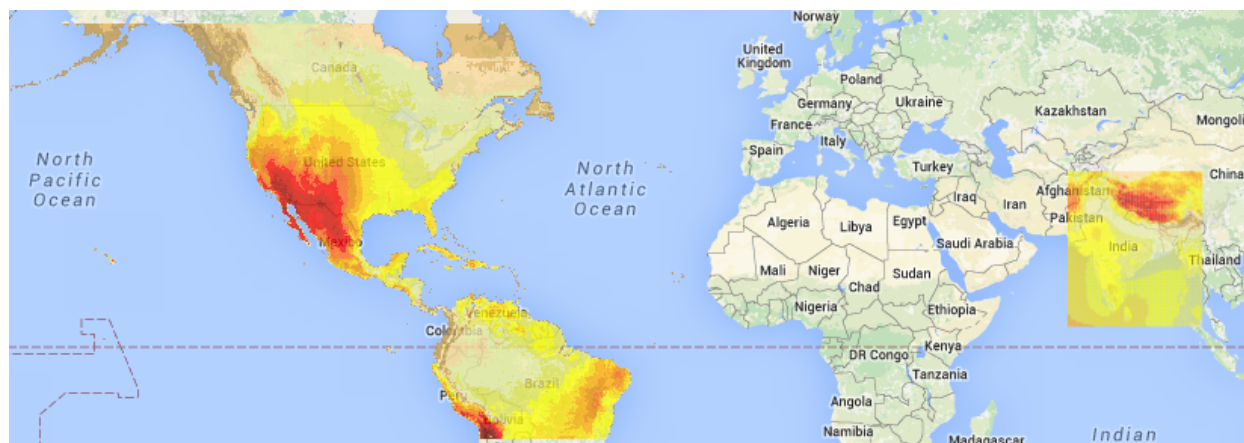
If the weather file contains albedo (ground reflectance) data, the average value of albedo values in the weather file. NaN indicates the file does not contain albedo data.

## ▼ About the NSRDB

The [NREL National Solar Radiation Database \(NSRDB\)](#) is an online database of weather files containing solar resource data in the [SAM CSV format](#). Files are available both as [typical-year](#) files and [single-year](#) files. The database covers the parts of the Americas and Asia shown in the map below. The current data is called PSM (Physical Solar Model) for the U.S., and SUNY for Asia. For details about the data see these pages on the NSRDB website:

- [U.S. data](#)
- [International data](#)

The NSRDB also contains legacy datasets for the U.S. from older versions of the NSRDB, including MTS3 (TMY3 1991-2010), MTS2 (TMY3 1991-2005), and MTS1 (TMY2 1961-1990). We recommend that you use the latest PSM data for your work in SAM, but the older data is available if you need it.



**Important Note for CSP Modelers!** SAM's CSP models assume that each DNI value in the weather file represents the average irradiance over the time step, and calculate sun angles for the midpoint of the time step. In weather files from the NSRDB, the irradiance data is measured instantaneously at either the beginning of the hour (TMY data), midpoint of the hour (single-year data), or beginning of the 30-minute time step (30-minute single-year data). As a result, if you use an NSRDB PSM weather file with a CSP model with either hourly TMY data or 30-minute single-year data, the sun angle for each time step will be for a different time than the time for the instantaneous irradiance values. See [Time Convention and Sun Position](#) for details.



**Notes.**

The NSRDB requires an email address to download weather file. When you download a weather file from SAM, SAM submits the email address that you used to [register SAM](#). NREL uses your email address to determine how many people are using the NSRDB. It does not share email addresses.

Different types of weather files in the NSRDB use different time conventions. See [Time Convention and Sun Position](#) for details.

When you download a file from the NSRDB website, SAM displays a "-" for the City, State, and Country fields because the NSRDB files do not contain that information. This will not affect simulation results. The location information SAM requires for simulations is latitude, longitude, elevation and time zone.

SAM uses the [Google Maps API Geocoding Service](#) service to identify the geographic coordinates (latitude and longitude) of a location when you type a street address or city and state name to identify the location.

For information about downloading weather files and data from other sources, see the [Weather Data](#) page on the SAM website.

SAM downloads weather files with the following hourly data from the NSRDB:

- Direct normal (beam) irradiance, DNI (W/m<sup>2</sup>)
- Diffuse horizontal irradiance, DHI (W/m<sup>2</sup>)
- Dry-bulb temperature (°C)
- Dew-point temperature (°C)
- Relative humidity (%), for single-year files only
- Atmospheric pressure (mbar)
- Wind speed at 2 meters above the ground (m/s)
- Wind direction (°E of N)
- Albedo

**Note.** Weather files with snow depth data for the Detailed Photovoltaic model are not available from the NSRDB PSM dataset. They are available for 239 locations in the United States from the legacy [MTS1 \(TMY2\) files in the original format](#), which cover the period 1961 - 1990. See [Snow Losses](#) for details.

## 18.2 System Costs

SAM uses the variables on the Trough System Costs page to calculate the project investment cost and annual operating costs reported in the project [cash flow](#) and used to calculate cost metrics reported in the Metrics table on the [Results page](#).

Because only the total installed cost value affects the cash flow calculations, you can assign capital costs to the different cost categories in whatever way makes sense for your analysis. For example, you could

assign the cost of designing the solar field to the solar field cost category or to the engineer-procure-construct category with equivalent results. The categories are provided to help you keep track of the different costs, but do not affect the economic calculations. After assigning costs to the categories, verify that the total installed costs value is what you expect.

Variable values in boxes with white backgrounds are values that you can edit. Boxes with blue backgrounds contain calculated values or values from other pages that SAM displays for your information.

#### **CSP System Cost Notes.**

The default cost values that appear when you create a file or case are intended to illustrate SAM's use. The cost data are meant to be realistic, but not to represent actual costs for a specific project. For more information and a list of online resources for cost data, see the [SAM website](#).

The direct capital costs in \$/kWe are in kilowatts of gross power block capacity rather than nameplate capacity because the size and cost of the power block is determined by the gross capacity, not the net capacity. The total installed cost in \$/kWe (actually overnight installed cost because it does not include financing during construction costs, which are accounted for on the [Financial Parameters](#) page) is in kilowatts of nameplate capacity, because that is what is delivered to the grid and is consistent with how costs are reported for utility generation technologies. The indirect costs in \$/Wac are in Watts of nameplate power block capacity because those costs that use the entire plant as the basis, not just the power block.

The System Costs page only available for cases with a cash-flow-based financial mode. It is not available with the No Financial Model option or the LCOE Calculator financial model.

## **Direct Capital Costs**

A direct capital cost represents an expense for a specific piece of equipment or installation service that applies in year zero of the cash flow.

**Note:** Because SAM uses only the total installed cost value in cash flow calculations, how you distribute costs among the different direct capital cost categories does not affect the final results.

### **Site Improvements (\$/m<sup>2</sup>)**

A cost per square meter of solar field area to account for expenses related to site preparation and other equipment not included in the solar field cost category.

### **Solar Field (\$/m<sup>2</sup>)**

A cost per square meter of solar field area to account for expenses related to installation of the solar field, including labor and equipment.

### **HTF System (\$/m<sup>2</sup>)**

A cost per square meter of solar field area to account for expenses related to installation of the heat transfer fluid pumps and piping, including labor and equipment.

### **Storage (\$/kWh)**

Cost per thermal megawatt-hour of storage capacity to account for expenses related to installation of the thermal storage system, including equipment and labor.

**Fossil Backup (\$/kWe)**

Cost per electric megawatt of power block gross capacity to account for the installation of a fossil backup system, including equipment and labor.

**Power Plant (\$/kWe)**

Cost per electric megawatt of power block gross capacity to account for the installation of the power block, including equipment and labor.

**Balance of Plant (\$/kWe)**

Cost per electric megawatt of power block gross capacity to account for additional costs.

**Contingency (%)**

A percentage of the sum of the site improvements, solar field, HTF system, storage, fossil backup, and power plant costs to account for expected uncertainties in direct cost estimates.

**Total Direct Cost (\$)**

The sum of improvements, solar field, HTF system, storage, fossil backup, power plant costs, and contingency costs.

**Indirect Capital Costs**

An indirect cost is typically one that cannot be identified with a specific piece of equipment or installation service.

**Note:** Because SAM uses only the total installed cost value in cash flow calculations, how you distribute costs among the different indirect capital cost categories does not affect the final results.

**Total Land Area**

The total land area required for the project, from the Solar Field or Heliostat Field page.

**Nameplate**

The system's nameplate capacity from the Power Block or Power Cycle page.

**EPC and Owner Cost**

EPC (engineer-procure-construct) and owner costs are associated with the design and construction of the project. SAM calculates the total cost as the sum of the Non-fixed Cost and Fixed Cost.

Typical costs that may be appropriate to include in the EPC and Owner category are: Permitting, royalty payments, consulting, management or legal fees, geotechnical and environmental surveys, interconnection costs, spare parts inventories, commissioning costs, and the owner's engineering and project development activities.

**Total Land Costs**

Costs associated with land purchases, which SAM calculates as the sum of a non-fixed cost and a fixed cost. Use the Land category described below for land costs, and inputs on the [Financial Parameters](#) page for financing costs.

SAM calculates the total EPC and Owner Costs and Total Land Costs by adding the four costs that you can specify using different units.

**\$/acre**

A cost in dollars per total land area in acres.

**% of direct cost**

A cost as a percentage of **Total Direct Cost** under **Direct Capital Cost**.

**\$/Wac**

A cost in dollars per AC Watt of nameplate capacity.

**\$**

A fixed dollar amount

**Sales Tax****Sales tax basis, %**

The percentage of total direct cost used to calculate sales tax amount.

SAM calculates the total sales tax amount by multiplying the sales tax rate from the [Financial Parameters](#) page by the sales tax basis on the System Costs page:

$$\text{Total Sales Tax (\$)} = \text{Sales Tax Rate (\%)} \times \text{Sales Tax Basis (\%)} \times \text{Total Direct Cost (\$)}$$

For an explanation of the effect of sales tax on income tax, see **Sales Tax** on the [Financial Parameters](#) topic for the financial model you are using (Residential, Commercial, Single Owner, etc.)

**Total Indirect Cost (\$)**

The sum of engineer-procure-construct costs, project-land-miscellaneous costs, and sales tax.

**Total Installed Cost**

The total installed cost is the sum of all of the direct and indirect capital costs that you specify. SAM uses this value to calculate the project's [net capital cost](#), which is the total installed cost less any cash incentives on the [Incentives](#) page and plus any additional financing costs from [Financial Parameters](#) page.

**Total installed cost (\$)**

The sum of total direct cost and total indirect cost.

**Total installed cost per capacity (\$/Wdc or \$/kW)**

Total installed cost divided by the total system rated or nameplate capacity. This value is provided for reference only. SAM does not use it in cash flow calculations.

**Operation and Maintenance Costs**

Operation and Maintenance (O&M) costs represent annual expenditures on equipment and services that occur after the system is installed. SAM allows you to enter O&M costs in three ways: Fixed annual, fixed by capacity, and variable by generation. O&M costs are reported on the project [cash flow](#).

For each O&M cost category, you can specify an optional annual **Escalation Rate** to represent an expected annual increase in O&M cost above the annual inflation rate specified on the [Financial Parameters](#). For an escalation rate of zero, the O&M cost in years two and later is the year one cost adjusted for inflation. For a non-zero escalation rate, the O&M cost in years two and later is the year one cost adjusted for inflation plus escalation.

For expenses such as component replacements that occur in particular years, you can use an annual schedule to assign costs to individual years. See below for details.

**Fixed Annual Cost (\$/yr)**

A fixed annual cost that applied to each year in the project cash flow.

**Fixed Cost by Capacity (\$/kW-yr)**

A fixed annual cost proportional to the system's rated or nameplate capacity.

**Variable Cost by Generation (\$/MWh)**

A variable annual cost proportional to the system's total annual electrical output in AC megawatt-hours. The annual energy output depends on either the performance model's calculated first year value and the **degradation rate** from the [Lifetime](#) page, or on an annual schedule of costs, depending on the option chosen.

**Fossil Fuel Cost (\$/MMBtu)**

The cost per million British thermal units for fuel. SAM uses the conversion factor 1 MWh = 3.413 MMBtu. SAM calculates a fossil fuel cost for concentrating solar power systems with fossil backup, and for the generic system when the heat rate on the [Power Plant](#) page is not zero.

**Note.** If you are using the [generic system](#) model to represent a system that does not consume fuel, you should use a fuel cost of zero.

**Entering Periodic Operation and Maintenance Costs**

SAM allows you to specify any of the four operation and maintenance (O&M) cost categories on the System Costs page either as a single annual cost, or using a table of values to specify an annual schedule of costs. An annual schedule makes it possible to assign costs to particular years in the analysis period. Annual schedules can be used to account for component replacement costs and other periodic costs that do not recur on a regular annual basis.

You choose whether to specify an O&M cost as a single annual value or an annual schedule with the grey and blue button next to each variable. SAM uses the option indicated by the blue highlight on the button: A blue highlighted "Value" indicates a single, regularly occurring annual value. A blue highlighted "Sched" indicates that the value is specified as an annual schedule.

For example, to account for component replacement costs, you can specify the fixed annual cost category as an annual schedule, and assign the cost of replacing or rebuilding the component to particular years. For a 30-year project using a component with a seven-year life, you would assign a replacement cost to years seven, 14, and 21. Or, to account for expected improvements in the component's reliability in the future, you could assign component replacement costs in years seven, 17, and 27. After running a simulation, you can see the replacement costs in the project [cash flow](#) in the appropriate column under Operating Expenses. SAM accounts for the operating costs in the other economic metrics including the levelized cost of energy and net present value (NPV).

**Notes.**

If you use the annual schedule option to specify equipment replacement costs, SAM does not calculate any residual or salvage value of system components based on the annual schedule. SAM calculates salvage value separately, using the salvage value you specify on the [Financial Parameters](#) page.

Dollar values in the annual schedule are in nominal or current dollars. SAM does not apply inflation and escalation rates to values in annual schedules.

The following procedure describes how to define the fixed annual cost category as an annual schedule. You can use the same procedure for any of the other operation and maintenance cost categories.

**To assign component replacement costs to particular years:**

1. In the Fixed Annual Cost category, note that the "Value" label of the grey and blue button is blue indicating that the single value mode is active for the variable.

Fixed Annual Cost  \$/yr

In this case, SAM would assign an annual cost of \$284 to each year in the project cash flow.

2. Click the button so that "Sched" label is highlighted in blue. SAM replaces the variable's value with an Edit button.

3. Click **Edit** to open the [Edit Schedule](#) window.
4. In the Edit Schedule window, use the vertical scroll bar to find the year of the first replacement, and type the replacement cost in current or constant dollars for that year.

To delete a value, select it and press the Delete key on your keyboard.

**Note.** You must type a value for each year. If you delete a value, SAM will clear the cell, and you must type a number in the cell or SAM will consider the schedule to be invalid. Type a zero for years with no annual costs.

5. When you have finished editing the schedule, click **Accept**.

Because you must specify an O&M cost category as either an annual cost or annual schedule, to assign both a recurring annual fixed cost and periodic replacement cost, you must type the recurring cost in each year of the annual schedule, and for years with replacement costs, type the sum of the recurring and replacement costs.

## About the CSP Default Cost Assumptions

The default values the System Costs page for the CSP models reflect the National Renewable Energy Laboratory's best estimate of representative costs for CSP systems in the United States at the time of the release of the current version of SAM. The values are based on cost studies undertaken by NREL, review of published literature, and conversations with developers and industry insiders. Costs are reviewed prior to each new SAM release.

**Note.** Always review all of the inputs for your SAM project to determine whether they are appropriate for your analysis.

The parabolic trough and power tower system cost default values were largely developed from the following studies:

- Kurup, P.; Turchi, C. S. (2015). "Parabolic Trough Collector Cost Update for the System Advisor Model (SAM)," NREL/TP-6A20-65228, 2015. ([PDF 2.1 MB](#))
- Turchi, C. S.; Heath, G. A. (2013). "Molten Salt Power Tower Cost Model for the System Advisor Model (SAM)," NREL/TP-5500-57625, 2013. ([PDF 2.5 MB](#))
- Kolb, G. J.; Ho, C. K. (2011), T. R. Mancini, and J. A. Gary, "Power Tower Technology Roadmap and Cost Reduction Plan," SAND2011-2419. ([PDF 503 KB](#))
- Turchi, C. S. (2010). "Parabolic Trough Reference Plant for Cost Modeling with the Solar Advisor Model (SAM)," NREL/TP-550-47605. ([PDF 7.2 MB](#))

These studies differed in some important assumptions. The differences in the location and cooling method

assumptions for the default cases of the CSP technologies are outlined in the following table. The choice of location affects solar resource and the assumed labor costs associated with the case. Construction labor rates in Arizona tend to be lower than in California, which reduces installed costs. For the Winter 2016 version of SAM, all CSP systems are assumed to use dry cooling. SAM can model systems with dry cooling, wet cooling, or a hybrid of the two. If you change the type of cooling system on the Power Cycle input page, you should also change other parameters as appropriate because SAM does not make those changes automatically. For example, different types of cooling systems would require different power cycle costs and design-point performance parameters. Perhaps less obvious, the site preparation costs are lower for dry-cooled (air-cooled) systems than for wet-cooled (evaporative) systems because of the elimination of the large blowdown evaporation ponds required for wet systems.

Technology	Default Location	Default Cooling method
Physical Trough	SW Arizona (Tucson weather file)	Dry
Empirical Trough	SW Arizona (Tucson weather file)	Dry
Molten Salt Power Tower	Southern California (Daggett weather file)	Dry
Linear Fresnel	SW Arizona (Tucson weather file)	Dry
Generic Solar	SW Arizona (Tucson weather file)	Dry

The trough, tower, and linear Fresnel models assume the “balance of plant” cost category is composed of the steam generation system (Kolb, 2011). This choice is made to allow users to highlight the effect of a direct steam generation (DSG) design. In a DSG design, the balance of plant cost category is zero because steam generation occurs in the solar receiver.

The lesser commercial activity in linear Fresnel systems makes cost values for those technologies more uncertain than for troughs and towers. Linear Fresnel costs are estimated based on discussions with developers and researchers.

## 18.3 Solar Multiple

Sizing the solar field of a parabolic trough system in SAM involves determining the optimal solar field aperture area for a system at a given location. In general, increasing the solar field area increases the system's electric output, thereby reducing the project's LCOE. However, during times when there is enough solar resource, too large of a field will produce more thermal energy than the power block and other system components can handle. Also, as the solar field size increases beyond a certain point, the higher installation and operating costs outweigh the benefit of the higher output.

An optimal solar field area should:

- Maximize the amount of time in a year that the field generates sufficient thermal energy to drive the power block at its rated capacity.
- Minimize installation and operating costs.
- Use thermal energy storage and backup power equipment efficiently and cost effectively.

The problem of choosing an optimal solar field area involves analyzing the tradeoff between a larger solar field that maximizes the system's electrical output and project revenue, and a smaller field that minimizes installation and operating costs.

The levelized cost of energy (LCOE) is a useful metric for optimizing the solar field size because it includes the amount of electricity generated by the system, the project installation costs, and the cost of operating and maintaining the system over its life. Optimizing the solar field involves finding the solar field aperture area that results in the lowest LCOE. For systems with thermal energy storage systems, the optimization involves finding the combination of field area and storage capacity that results in the lowest LCOE.

## Option 1 and Option 2

SAM provides two options for specifying the solar field aperture area on the [System Design](#) page: Option 1 (solar multiple) allows you to specify the solar field area as a multiple of the power block's rated capacity (design turbine gross output), and Option 2 (field aperture) allows you to specify the solar field aperture area as an explicit value in square meters.

- Option 1: You specify a solar multiple, and SAM calculates the solar field aperture area required to meet power block rated capacity.
- Option 2: You specify the aperture area independently of the power block's rated capacity.

If your analysis involves a known solar field area, you should use Option 2 to specify the solar field aperture area explicitly.

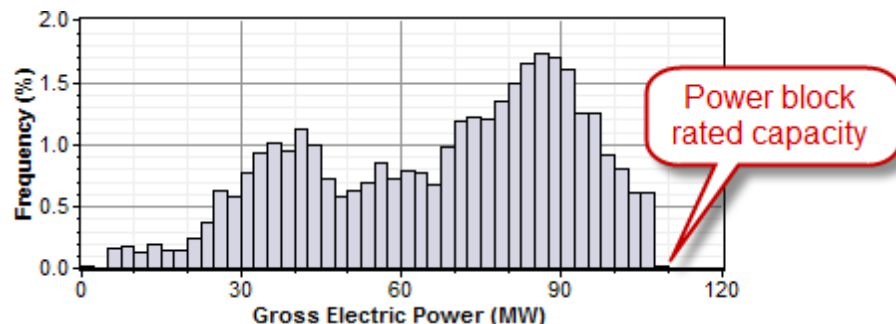
If your analysis involves optimizing the solar field area for a specific location, or choosing an optimal combination of solar field aperture area and thermal energy storage capacity, then you should choose Option 1, and follow the procedure described below to size the field.

## Solar Multiple

The solar multiple makes it possible to represent the solar field aperture area as a multiple of the power block rated capacity. A solar multiple of one ( $SM=1$ ) represents the solar field aperture area that, when exposed to solar radiation equal to the design radiation value (irradiation at design), generates the quantity of thermal energy required to drive the power block at its rated capacity (design gross output), accounting for thermal and optical losses.

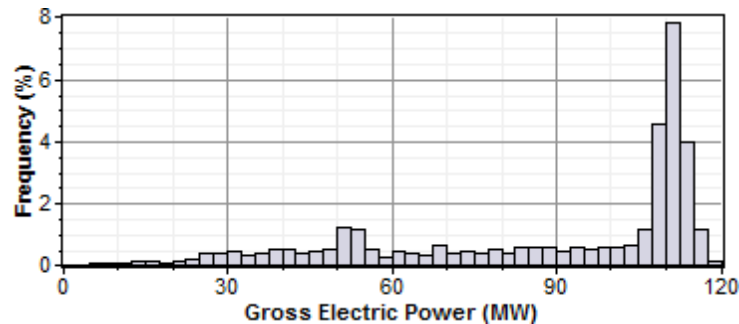
Because at any given location the number of hours in a year that the actual solar resource is equal to the design radiation value is likely to be small, a solar field with  $SM=1$  will rarely drive the power block at its rated capacity. Increasing the solar multiple ( $SM>1$ ) results in a solar field that operates at its design point for more hours of the year and generates more electricity.

For example, consider a system with a power block design gross output rating of 111 MW and a solar multiple of one ( $SM=1$ ) and no thermal storage. The following frequency distribution graph shows that the power block never generates electricity at its rated capacity, and generates less than 80% of its rated capacity for most of the time that it generates electricity:

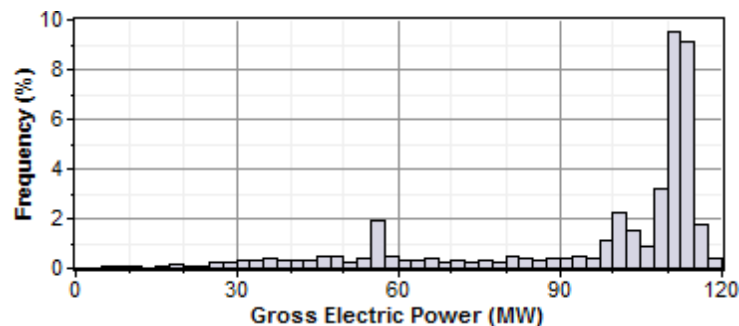




For the same system with a solar multiple chosen to minimize LCOE (in this example  $SM=1.5$ ), the power block generates electricity at or slightly above its rated capacity almost 15% of the time:



Adding thermal storage to the system changes the optimal solar multiple, and increases the amount of time that the power block operates at its rated capacity. In this example, the optimal storage capacity (full load hours of TES) is 3 hours with  $SM=1.75$ , and the power block operates at or over its rated capacity over 20% of the time:



**Note.** For clarity, the frequency distribution graphs above exclude nighttime hours when the gross power output is zero.

## Reference Weather Conditions for Field Sizing

The design weather conditions values are reference values that represent the solar resource at a given location for solar field sizing purposes. The field sizing equations require three reference condition variables:

- Ambient temperature
- Direct normal irradiance (DNI)
- Wind velocity

The values are necessary to establish the relationship between the field aperture area and power block rated capacity for solar multiple (SM) calculations.

**Note.** The design values are different from the data in the weather file. SAM uses the design values to size the solar field before running a simulation. During the simulation, SAM uses data from the weather file you choose on the Location and Resource page.

The reference ambient temperature and reference wind velocity variables are used to calculate the design heat losses, and do not have a significant effect on the solar field sizing calculations. Reasonable values for those two variables are the average annual measured ambient temperature and wind velocity at the project location. For the physical trough model, the reference temperature and wind speed values are hard-coded

and cannot be changed. The linear Fresnel and generic solar system models allow you to specify the reference ambient temperature value, but not the wind speed. The empirical trough model allows you to specify both the reference ambient temperature and wind speed values.

The reference direct normal irradiance (DNI) value, on the other hand, does have a significant impact on the solar field size calculations. For example, a system with reference conditions of 25°C, 950 W/m<sup>2</sup>, and 5 m/s (ambient temperature, DNI, and wind speed, respectively), a solar multiple of 2, and a 100 MWe power block, requires a solar field area of 871,940 m<sup>2</sup>. The same system with reference DNI of 800 W/m<sup>2</sup> requires a solar field area of 1,055,350 m<sup>2</sup>.

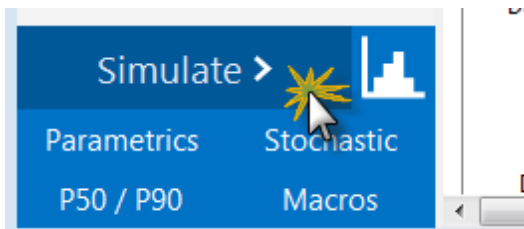
In general, the reference DNI value should be close to the maximum actual DNI on the field expected for the location. For systems with horizontal collectors and a field azimuth angle of zero in the Mohave Desert of the United States, we suggest a design irradiance value of 950 W/m<sup>2</sup>. For southern Spain, a value of 800 W/m<sup>2</sup> is reasonable for similar systems. However, for best results, you should choose a value for your specific location using one of the methods described below.

Linear collectors (parabolic trough and linear Fresnel) typically track the sun by rotating on a single axis, which means that the direct solar radiation rarely (if ever) strikes the collector aperture at a normal angle. Consequently, the DNI incident on the solar field in any given hour will always be less than the DNI value in the resource data for that hour. The cosine-adjusted DNI value that SAM reports in simulation results is a measure of the incident DNI.

Using too low of a reference DNI value results in excessive "dumped" energy: Over the period of one year, the actual DNI from the weather data is frequently greater than the reference value. Therefore, the solar field sized for the low reference DNI value often produces more energy than required by the power block, and excess thermal energy is either dumped or put into storage. On the other hand, using too high of a reference DNI value results in an undersized solar field that produces sufficient thermal energy to drive the power block at its design point only during the few hours when the actual DNI is at or greater than the reference value.

#### **To choose a reference DNI value:**

1. Choose a weather file on the Location and Resource page.
2. For systems with storage, specify the storage capacity and maximum storage charge rate defined on the System Design page.
3. Click **Simulate**.



4. On the Results page, click **Statistics**.
5. Read the maximum annual value of **Field collector DNI-cosine product (W/m<sup>2</sup>)**, and use this value for the reference DNI.

An alternative method is to choose a reference DNI value on the System Design page to minimize collector defocusing, to do this, try different values for Design point DNI on the System Design page until you find a value that minimizes the total Field fraction of focused SCAs output variable on the Statistics tab. You could also use [parametric simulations](#) to find the reference DNI value.

## 18.4 Custom HTF

If the heat transfer fluid you want to use in the solar field is not included in the Field HTF Fluid list, you can define a custom heat transfer fluid using the User-defined option in the list. To define a custom fluid, you need to know the following properties for at least two temperatures:

- Temperature, °C
- Specific heat, kJ/kg-K
- Density, kg/m<sup>3</sup>
- Viscosity, Pa-s
- Kinematic viscosity, m<sup>2</sup>-s
- Conductivity, W/m-K
- Enthalpy, J/kg

### To define a custom heat transfer fluid:

1. In the Field HTF fluid list, click **User-defined**.
2. In the Edit Material Properties table, change **Number of data points** to 2 or higher. The number should equal the number of temperature values for which you have data.
3. Type values for each property in the table.

You can also import data from a text file of comma-separated values. Each row in the file should contain properties separated by commas, in the same the order that they appear in the Edit Material Properties window. Do not include a header row in the file.

### Notes

Each row in the materials property fluid table must be for a set of properties at a specific temperature. No two rows should have the same temperature value.

SAM calculates property values from the table using linear interpolation.

The rows in the table must sorted by the temperature value, in either ascending or descending order.

The [physical trough model](#) uses the temperature, specific heat, density, viscosity, and conductivity values. It ignores the enthalpy and kinematic viscosity values (the [empirical trough model](#) does use those values).

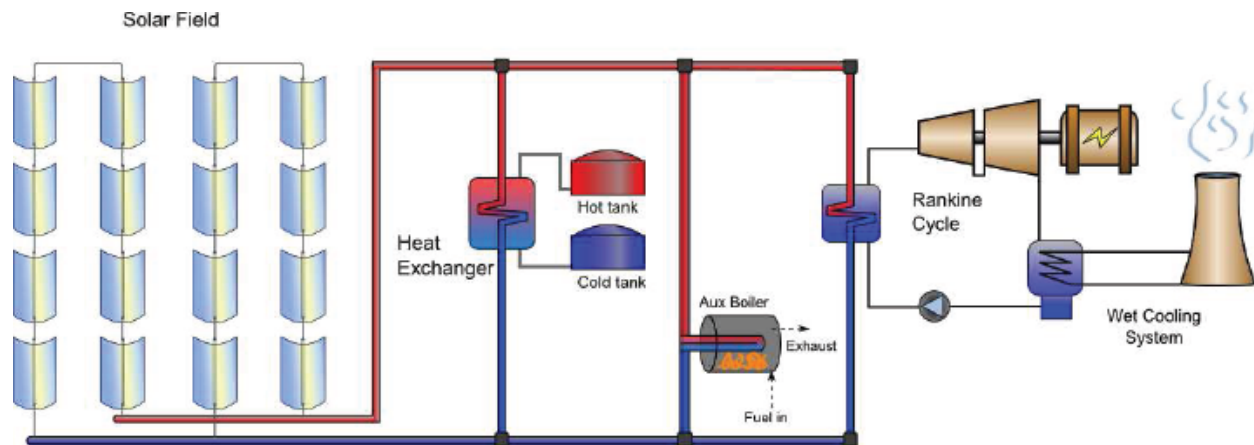
For the physical trough model, if you specify user-defined HTF fluids with the same properties for the solar field and thermal storage system, on the [Thermal Storage](#) page, SAM disables the **Hot side HX approach temp** and **Cold side HX approach temp** inputs, and sets them to zero internally to represent a system with no heat exchanger. (When the hot and cold side approach temperatures are zero, **Thermal storage exergetic efficiency** is one.)

## 18.5 Physical Trough Model

The physical trough model calculates the electricity delivered to the grid by a parabolic trough solar field that delivers thermal energy to a power block for electricity generation, with an optional thermal energy storage system. The physical trough model characterizes many of the system components from first principles of heat transfer and thermodynamics, rather than from empirical measurements as in the empirical trough system model. While the physical trough model is more flexible than the [empirical trough](#) model, it adds more uncertainty to performance predictions than the empirical model.

For more information about the model, including a demonstration video and technical reference manuals, see the [SAM website](#).

A parabolic trough system is a type of concentrating solar power (CSP) system that collects direct normal solar radiation and converts it to thermal energy that runs a power block to generate electricity. The components of a parabolic trough system are the solar field, power block, and in some cases, thermal energy storage and fossil backup systems. The solar field collects heat from the sun and consists of parabolic, trough-shaped solar collectors that focus direct normal solar radiation onto tubular receivers. Each collector assembly consists of mirrors and a structure that supports the mirrors and receivers, allows it to track the sun on one axis, and can withstand wind-induced forces. Each receiver consists of a metal tube with a solar radiation absorbing surface in a vacuum inside a coated glass tube. A heat transfer fluid (HTF) transports heat from the solar field to the power block (also called power cycle) and other components of the system. The power block is based on conventional power cycle technology, using a turbine to convert thermal energy from the solar field to electric energy. The optional fossil-fuel backup system delivers supplemental heat to the HTF during times when there is insufficient solar energy to drive the power block at its rated capacity.



The physical trough system model approaches the task of characterizing the performance of the many of the system components from first principles of heat transfer and thermodynamics, rather than from empirical measurements as in the empirical trough model. The physical model uses mathematical models that represent component geometry and energy transfer properties, which gives you the flexibility to specify characteristics of system components such as the absorber emissivity or envelope glass thickness. The empirical model, on the other hand, uses a set of curve-fit equations derived from regression analysis of data measured from real systems, so you are limited to modeling systems composed of components for which there is measured data. While the physical model is more flexible than the empirical model, it adds more uncertainty to performance predictions than the empirical model. In a physical model, uncertainty in the geometry and property assumptions for each system component results in an aggregated uncertainty at the

system level that tends to be higher than the uncertainty in an empirical model. We've included both models in SAM so that you can use both in your analyses.

The following are some key features of the physical model:

- Includes transient effects related to the thermal capacity of the heat transfer fluid in the solar field piping, headers, and balance of plant.
- Allows for flexible specification of solar field components, including multiple receiver and collector types within a single loop.
- Relatively short simulation times to allow for [parametric](#) and [statistical](#) analyses that require multiple simulation runs.

## 18.5.1 System Design

The System Design page shows inputs for design point parameters that determine the system's nameplate capacity. Use the System Design inputs to define the nominal ratings of the system, and then specify details for each part of the system on the appropriate input pages.

**Note.** All of the system design inputs are nominal values, or values at the system's design point. SAM calculates actual values during simulation and reports them in the [results](#).

### Solar Field

The solar field design parameters determine the size of the solar field. See the [Solar Field](#), [Collectors \(SCAs\)](#), and [Receivers \(HCEs\)](#) pages to set detailed parameters for the field.

#### Option 1 and Option 2

For Option 1 (solar multiple mode), SAM calculates the total required aperture and number of loops based on the value you enter for the solar multiple.

For option 2 (field aperture mode), SAM calculates the solar multiple based on the field aperture value you enter. Note that SAM does not use the value that appears dimmed for the inactive option. See [Solar Multiple](#) for details.

#### Solar Multiple

The field aperture area expressed as a multiple of the aperture area required to operate the power cycle at its design capacity. See [Solar Multiple](#) for details.

#### Field Aperture (m<sup>2</sup>)

The total solar energy collection area of the solar field in square meters. Note that this is less than the total mirror surface area.

**Note.** For simulations, SAM uses the **Actual Solar Multiple** and **Total Aperture Reflective Area** values shown under **Solar Field Design Point** on the [Solar Field](#) page. The calculated value of the inactive option may differ from the value you see on the System Design page.

**Design point DNI (W/m<sup>2</sup>)**

The design point direct normal radiation value, used in solar multiple mode to calculate the aperture area required to drive the power cycle at its design capacity. Also used to calculate the design mass flow rate of the heat transfer fluid for header pipe sizing.

**Field thermal power, MWt**

The field thermal power output at design.

$$\text{Field Thermal Power (MWt)} = \text{Solar Multiple} \times \text{Cycle Thermal Power (MWt)}$$

**Loop inlet HTF temperature (°C)**

The temperature of HTF at the loop inlet under design conditions. The actual temperature during operation may differ from this value. SAM sets the power cycle's design outlet temperature equal to this value.

**Loop outlet HTF temperature (°C)**

The temperature of the HTF at the outlet of the loop under design conditions. During operation, the actual value may differ from this set point. This value represents the target temperature for control of the HTF flow through the solar field and will be maintained when possible.

**Number of loops**

The number of loops in the field, equal to the solar multiple times the required number of loops at a solar multiple of 1.0. The required number of loops is rounded to the nearest integer to represent a realistic field layout.

**Power Cycle**

The power cycle design parameters determine the capacity of the power cycle, and the nameplate capacity of the system. See the [Power Cycle](#) page for more detailed power cycle options and detailed parameters.

**Design turbine gross output (MWe)**

The power cycle's design output, not accounting for parasitic losses. SAM uses this value to size system components, such as the solar field area when you use the solar multiple to specify the solar field size.

**Estimated gross to net conversion factor**

An estimate of the ratio of the electric energy delivered to the grid to the power cycle's gross output. SAM uses the factor to calculate the power cycle's nameplate capacity for capacity-related calculations, including the estimated total cost per net capacity value on the [Trough System Costs](#) page, capacity-based incentives on the [Incentives](#) page, and the capacity factor reported in the [results](#).

**Estimated net output at design (nameplate) (MWe)**

The power cycle's nameplate capacity, calculated as the product of the design gross output and estimated gross to net conversion factor.

$$\text{Estimated Net Output at Design (MWe)} = \text{Design Gross Output (MWe)} \times \text{Estimated Gross to Net Conversion Factor}$$

**Cycle thermal efficiency**

The thermal to electric conversion efficiency of the power cycle under design conditions

**Cycle thermal power, MWt**

The power cycle thermal power input at design.

$$\text{Cycle Thermal Power, MWt} = \text{Design Turbine Gross Output (MWe)} \div \text{Cycle Thermal Efficiency}$$

## Thermal Storage

The thermal storage design parameters determine the size of the thermal energy storage system (TES). See the [Thermal Storage](#) page for detailed TES parameters.

### Hours of storage at design point (hours)

The thermal storage capacity expressed in number of hours of thermal energy delivered at the design power cycle thermal power. The physical capacity is the number of hours of storage multiplied by the power cycle design thermal input. Used to calculate the thermal energy system's maximum storage capacity.

## 18.5.2 Solar Field

The Solar Field page displays variables and options that describe the size and properties of the solar field, and properties of the heat transfer fluid. It also displays reference design specifications of the solar field.

**Note.** For a detailed explanation of the physical trough model, see Wagner, M. J.; Gilman, P. (2011). *Technical Manual for the SAM Physical Trough Model*. 124 pp.; NREL Report No. TP-5500-51825. <http://www.nrel.gov/docs/fy11osti/51825.pdf> (3.7 MB)

## Solar Field Design Point

The design point variables show values at the design-point DNI from the [System Design](#) page and are values that SAM uses to determine the system capacity in sizing calculations, and for area-based costs on the [System Costs](#) page.

### Single loop aperture (m<sup>2</sup>)

The aperture area of a single loop of collectors, equal to the product of aperture width, reflective area, times the structure length times the number of collector assemblies per loop according to the distribution of the up to four collector types in the field. This area does not include non-reflective surface on the collector or non-reflective space between collectors.

$$\text{Single Loop Aperture (m}^2\text{)} = \text{Sum of the SCA Reflective Aperture Area (m}^2\text{) values for each SCA in the loop}$$

The SCA reflective aperture area for each SCA type is specified on the [Collectors \(SCAs\)](#) page. The number of each type of SCA in a single loop is specified under **Single Loop Configuration** as described in [Specifying the Loop Configuration](#).

### Loop optical efficiency

The optical efficiency when incident radiation is normal to the aperture plane, not including end losses or cosine losses. This value does not include thermal losses from piping and the receivers.

$$\text{Loop Optical Efficiency} = \text{SCA Optical Efficiency at Design} \times \text{HCE Optical Derate}$$

The SCA and HCE optical efficiency values are from the [Collectors \(SCA\)](#) page and [Receivers \(HCEs\)](#) page, respectively.

**Total loop conversion efficiency**

The total conversion efficiency of the loop, including optical losses and estimated thermal losses. Used to calculate the required aperture area of the solar field.

$$\text{Total Loop Conversion Efficiency} = \text{Loop Optical Efficiency} \times \text{Receiver Heat Loss Efficiency}$$

**Total required aperture, SM=1 (m<sup>2</sup>)**

The exact mirror aperture area required to meet the design thermal output for a solar multiple of 1.0. SAM uses the required aperture to calculate the total aperture reflective area. The total aperture reflective area may be slightly more or less than the required aperture, depending on the collector dimensions you specify on the [Collectors page](#).

$$\text{Total Required Aperture at SM of One (m}^2\text{)} = \text{Cycle Thermal Power (MWt)} \div (\text{Design Point DNI (W/m}^2\text{)} \times \text{Total Loop Conversion Efficiency}) \times (1\text{E6 W/MW})$$

**Required number of loops, SM=1**

The exact number of loops required to produce the total required aperture at a solar multiple of 1.0.

$$\text{Required Number of Loops at SM of One} = \text{CEILING}(\text{Total Required Aperture at SM of One} \div \text{Single Loop Aperture (m}^2\text{)})$$

**Total tracking power (W)**

Electrical power required for tracking motors in the solar field.

$$\text{Total Tracking Power (W)} = \text{Number of SCAs per Loop} \times \text{Actual Number of Loops} \times \text{Tracking Power per SCA (W)}$$

**Actual number of loops**

The actual number of loops in the field, equal to the solar multiple times the required number of loops at a solar multiple of 1.0. The required number of loops is rounded to the nearest integer to represent a realistic field layout.

**Total aperture reflective area (m<sup>2</sup>)**

The actual aperture area based on the actual number of loops in the field, equal to the single loop aperture times the actual number of loops.

$$\text{Total Aperture Reflective Area (m}^2\text{)} = \text{Single Loop Aperture (m}^2\text{)} \times \text{Actual Number of Loops}$$

**Actual solar multiple**

For Option 1 (solar multiple mode), the calculated solar multiple based on the actual (rounded) number of loops in the field.

For Option 2 (field aperture mode), the solar multiple value corresponding to the thermal output of the field based at design point: The total aperture reflective area divided by the field thermal output.

**Actual field thermal output (MWt)**

The thermal energy delivered by the solar field under design conditions at the actual solar multiple.

$$\text{Field Thermal Output (MWt)} = \text{Design Point DNI (W/m}^2\text{)} \times \text{Total Loop Conversion Efficiency} \times \text{Total Aperture Reflective Area (m}^2\text{)} \div 1\text{E6 W/MW}$$

**Loop inlet HTF temperature (°C)**

The design temperature of heat transfer fluid (HTF) at the loop inlet, from the [System Design](#) page.

**Loop outlet HTF temperature (°C)**

The design temperature of heat transfer fluid (HTF) at the loop outlet, from the [System Design](#) page.



## Solar Field Parameters

### Row spacing (m)

The centerline-to-centerline distance in meters between rows of collectors, assuming that rows are laid out uniformly throughout the solar field. Default is 15 meters.

### Header pipe roughness (m)

The header pipe roughness is a measure of the internal surface roughness of the header and runner piping. SAM uses this value in calculation of the shear force and piping pressure drops.

Surface roughness is important in determining the scale of the pressure drop throughout the system. As a general rule, the rougher the surface, the higher the pressure drop (and parasitic pumping power load). The surface roughness is a function of the material and manufacturing method used for the piping.

### HTF pump efficiency

The electrical-to-mechanical energy conversion efficiency of the field heat transfer fluid pump. This value accounts for all mechanical, thermodynamic, and electrical efficiency losses.

### Piping thermal loss coefficient (W/m<sup>2</sup>-K)

The thermal loss coefficient that is used to calculate thermal losses from piping between receivers, crossover piping, header piping, and runner piping. The coefficient specifies the number of thermal watts lost from the system as a function of the piping surface area, and the temperature difference between the fluid in the piping and the ambient air (dry bulb temperature). The length of crossover piping depends on the row spacing variable on the [Solar Field](#) page, and the piping distance between assemblies on the [Collectors](#) page.

### Wind stow speed, m/s

When the wind speed in the weather file exceeds this value, the collectors in field defocus and the field thermal power incident on the field goes to zero to model the effect of collectors moving to a safe position to avoid wind damage. When the wind speed falls below the wind stow speed, the field power returns to normal.

### Receiver startup delay time

The time in hours required to start the receiver. The receiver starts whenever the radiation incident on the field in the previous hour is zero, and there is sufficient thermal energy in the current hour to meet the thermal design requirement. SAM calculates the start up energy as the product of the available thermal energy, startup delay time, and startup delay energy fraction.

### Receiver startup delay energy fraction

Fraction of receiver design thermal power required by the receiver during the startup time.

### Collector startup energy, kWh/SCA

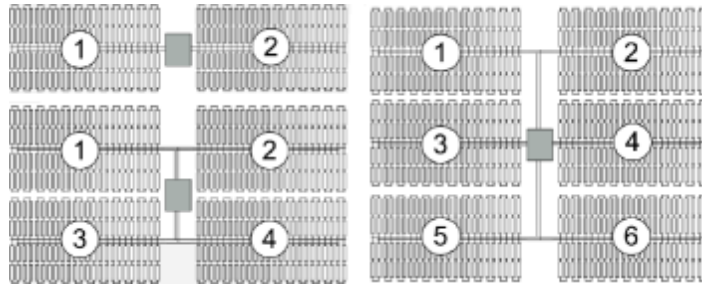
The electric energy in kilowatt-hours required to move one collector into position. Applies during the startup time.

### Tracking power per SCA, W/SCA

The electric power in Watts required by the tracking mechanism of one collector during hours of operation.

### Number of field subsections

SAM assumes that the solar field is divided into between two and 12 subsections. Examples of solar field with 2, 4, and 6 subsections are shown below:



The number of field subsections determine the location and shape of header piping that delivers heat transfer fluid to the power block, which affects the heat loss calculation.

### Allow partial defocusing

Partial defocusing assumes that the tracking control system can adjust the collector angle in response to the capacity of the power cycle (and thermal storage system, if applicable). See [Defining Collector Defocusing](#) for details.

## Heat Transfer Fluid

### Field HTF fluid

The heat transfer fluid (HTF) used in the heat collection elements and headers of the solar field. SAM includes the following options in the HTF library: Solar salt, Caloria, Hitec XL, Therminol VP-1, Hitec salt, Dowtherm Q, Dowtherm RP, Therminol 59, and Therminol 66. You can also define your own HTF using the user-defined HTF fluid option.

**Note.** During the simulation, SAM counts the number of instances that the HTF temperature falls outside of the operating temperature limits in the table below. If the number of instances exceeds 50, it displays a simulation [notice](#) with the HTF temperature and time step number for the 50th instance.

If you define a custom fluid, SAM disables the minimum and maximum operating temperature variables and displays zero because it does not have information about the operating limits for the fluid you defined. You can check the time series temperature data in the results to ensure that they do not exceed the limits for your custom fluid.

**Heat transfer fluids on the Field HTF Fluid list.**

Name	Type	Min Optimal Operating Temp °C	Max Optimal Operating Temp* °C	Freeze Point °C	Comments
Hitec Solar Salt	Nitrate Salt	238	593	238	
Hitec	Nitrate Salt	142	538	142	
Hitec XL	Nitrate Salt	120	500	120	
Caloria HT 43	Mineral Hydrocarbon	-12	315	-12 (pour point)	used in first Luz trough plant, SEGS I
Therminol VP-1	Mixture of Biphenyl and Diphenyl Oxide	12	400	12 (crystallization point)	Standard for current generation oil HTF systems
Therminol 59	Synthetic HTF	-45	315	-68 (pour point)	
Therminol 66	?	0	345	-25 (pour point)	
Dowtherm Q	Synthetic Oil	-35	330	n/a	
Dowtherm RP	Synthetic Oil	n/a	330	n/a	

\*The maximum optimal operating temperature is the value reported as "maximum bulk temperature" on the product data sheets.

**Data Sources for HTF Properties**

Hitec fluids: Raade J, Padowitz D, Vaughn J. [Low Melting Point Molten Salt Heat Transfer Fluid with Reduced Cost](#). Halotechnics. Presented at SolarPaces 2011 in Granada, Spain.

Caloria HT 43: [Product comparison tool](#) on Duratherm website.

Therminol Fluids: Solutia [Technical Bulletins](#) 7239115C, 7239271A, 7239146D.

Dowtherm Fluids: Dow [Data Sheet](#) for Q, no data sheet available for RP (high temp is from website): <http://www.dow.com/heattrans/products/synthetic/dowtherm.htm>.

**User-defined HTF fluid**

To define your own HTF, choose User-defined for the Field HTF fluid and specify a table of material properties for use in the solar field. You must specify at least two data points for each property: temperature, specific heat, density, viscosity, and conductivity. See [Custom HTF](#) for details.

**Field HTF min operating temp (°C)**

The minimum HTF operating temperature recommended by the HTF manufacturer.

In some cases the minimum operating temperature may be the same as the fluid's freeze point. However, at the freeze point the fluid is typically significantly more viscous than at design operation temperatures, so it is likely that the "optimal" minimum operating temperature is higher than the freeze point.

**Field HTF max operating temp (°C)**

The minimum HTF operating temperature recommended by the HTF manufacturer.

Operation at temperatures above this value may result in degradation of the HTF and be unsafe. To avoid this, you may want to include a safety margin and use a maximum operating temperature value slightly lower than the recommended value.

**Notes.**

SAM displays the operating temperature limits for your reference so you can compare them to the field temperatures reported in the results to ensure that they do not exceed the limits. SAM does not adjust the system's performance to avoid exceeding these operating limits.

SAM only displays these limits for fluids that are in SAM's library. If you use a custom HTF instead of one from the SAM library, SAM disables the HTF operating temperature limits. In this case, you should use data from the fluid manufacturer specifications and check the field timestep-averaged inlet and outlet temperatures in the results to ensure the limits are not exceeded.

**Freeze protection temp (°C)**

The minimum temperature that the heat transfer fluid is allowed to reach in the field. The temperature at which freeze protection equipment is activated.

SAM assumes that electric heat trace equipment maintains the fluid at the freeze protection temperature during hours that freeze protection is operating.

**Min single loop flow rate (kg/s)**

The minimum allowable flow rate through a single loop in the field.

During time steps that produce a solar field flow rate that falls below the minimum value, the HTF temperature leaving the solar field will be reduced in temperature according to the heat added and minimum mass flow rate.

**Max single loop flow rate (kg/s)**

The maximum allowable flow rate through a single loop in the field.

During time steps that produce a solar field flow rate that exceeds the maximum value, the solar field will be defocused according to the strategy selected by the user on the Solar Field page until the absorbed energy and corresponding mass flow rate fall below the maximum value.

**Min field flow velocity (m/s)**

The minimum allowable HTF flow velocity through the field.

$$\text{Minimum Field Flow Velocity (m/s)} = \text{Minimum Single Loop Flow Rate (kg/s)} \times 4 \div [\text{Fluid Density at Inlet Temperature (kg/m}^3) \times (\text{Minimum Absorber Tube Inner Diameter (m)})^2]$$

**Max field flow velocity (m/s)**

The maximum allowable HTF flow velocity through the field.

$$\text{Maximum Field Flow Velocity (m/s)} = \text{Maximum Single Loop Flow Rate (kg/s)} \times 4 \div [\text{Fluid Density at Inlet Temperature (kg/m}^3) \times (\text{Minimum Absorber Tube Inner Diameter (m)})^2]$$

**Header design min flow velocity (m/s)**

The minimum allowable HTF flow velocity in the header piping under design conditions, in the cold headers and hot headers, respectively.

**Header design max flow velocity (m/s)**

The maximum allowable HTF flow velocity in the header piping under design conditions in the cold headers and hot headers, respectively.

The minimum and maximum header flow velocities are used to determine the diameter of the header piping as flow is diverted to each loop in the field. After flow is distributed (or collected) to/from the loops, System Advisor calculates the flow velocity and resizes the piping to correspond to the maximum velocity if the calculated value falls outside of the user-specified range.

**Collector Orientation****Collector tilt (degrees)**

The angle of all collectors in the field in degrees from horizontal, where zero degrees is horizontal. A positive value tilts up the end of the array closest to the equator (the array's south end in the northern hemisphere), a negative value tilts down the southern end. SAM assumes that the collectors are fixed at the tilt angle.

**Collector azimuth (degrees)**

The azimuth angle of all collectors in the field, where zero degrees is pointing toward the equator, equivalent to a north-south axis. West is 90 degrees, and east is -90 degrees. SAM assumes that the collectors are oriented 90 degrees east of the azimuth angle in the morning and track the daily movement of the sun from east to west.

**Stow angle (degrees)**

The collector angle during the hour of stow. A stow angle of zero for a northern latitude is vertical facing east, and 180 degrees is vertical facing west. Default is 170 degrees.

**Deploy angle (degrees)**

The collector angle during the hour of deployment. A deploy angle of zero for a northern latitude is vertical facing due east. Default is 10 degrees.

**Mirror Washing**

SAM reports the water usage of the system in the results based on the mirror washing variables. The annual water usage is the product of the water usage per wash and 365 (days per year) divided by the washing frequency.

**Water usage per wash (L/m<sup>2</sup>,aper)**

The volume of water in liters per square meter of solar field aperture area required for periodic mirror washing.

**Washes per year**

The number of washes in a single year.

**Plant Heat Capacity**

The plant heat capacity values determine the thermal inertia due to the mass of hot and cold headers, and of SCA piping, joints, insulation, and other components whose temperatures rise and fall with the HTF temperature. SAM uses the thermal inertia values in the solar field energy balance calculations.

You can use the hot and cold piping thermal inertia inputs as empirical adjustment factors to help match SAM results with observed plant performance.

**Hot piping thermal inertia (kWht/K-MWt)**

The thermal inertia of the hot header to account for any thermal inertia not accounted for in the HTF volume calculations: Thermal energy in kilowatt-hours per gross electricity capacity in megawatts needed to raise the hot side temperature one degree Celsius. The default value is 0.2 kWht/K-MWt.

**Cold piping thermal inertia (kWht/K-MWt)**

The thermal inertia of the cold header to account for any thermal inertia not accounted for in the HTF volume calculations: Thermal energy in kilowatt-hours per gross electricity capacity in megawatts needed to raise the hot side temperature one degree Celsius. The default value is 0.2 kWht/K-MWt.

**Field loop piping thermal inertia (Wht/K-m)**

The thermal inertia of piping, joints, insulation, and other SCA components: The amount of thermal energy per meter of SCA length required to raise the temperature of piping, joints, insulation, and other SCA components one degree K. The default value is 4.5 Wht/K-m.

**Land Area**

The land area inputs determine the total land area in acres that you can use to estimate land-related costs in \$/acres on the [System Costs](#) page. The land area inputs are inputs to the financial model, not the performance model, so they do not affect the performance model energy calculations.

**Solar field area, acres**

The actual aperture area converted from square meters to acres:

$$\text{Solar Field Area (acres)} = \text{Actual Aperture (m}^2\text{)} \times \text{Row Spacing (m)} / \text{Maximum SCA Width (m)} \times 0.0002471 \text{ (acres/m}^2\text{)}$$

The maximum SCA width is the aperture width of SCA with the widest aperture in the field, as specified in the loop configuration and on the [Collectors \(SCA\)](#) page.

**Non-solar field land area multiplier**

Land area required for the system excluding the solar field land area, expressed as a fraction of the solar field aperture area. A value of one would result in a total land area equal to the total aperture area.

**Total land area, acres**

Land area required for the entire system including the solar field land area

$$\text{Total Land Area (acres)} = \text{Solar Field Area (acres)} \times (1 + \text{Non-Solar Field Land Area Multiplier})$$

The land area appears on the System Costs page, where you can specify land costs in dollars per acre.

**Single Loop Configuration****Number of SCA/HCE assemblies per loop**

The number of individual solar collector assemblies (SCAs) in a single loop of the field. Computationally, this corresponds to the number of simulation nodes in the loop. See [Specifying the Loop Configuration](#) for details.

**Edit SCAs**

Click **Edit SCAs** to assign an SCA type number (1-4) to each of the collectors in the loop. Use your mouse to select collectors, and type a number on your keyboard to assign a type number to the selected collectors. SAM indicates the SCA type by coloring the rectangle representing the collector in

the diagram, and displaying the type number after the word "SCA." See [Specifying the Loop Configuration](#) for details.

### Edit HCEs

Click **Edit HCEs** to assign a receiver type number (1-4) to each of the collectors in the loop. Use your mouse to select collectors, and type a number on your keyboard to assign a type number. SAM indicates the HCE type by coloring the line representing the receiver, and displaying the type number after the word "HCE." See [Specifying the Loop Configuration](#) for details.

### Edit Defocus Order

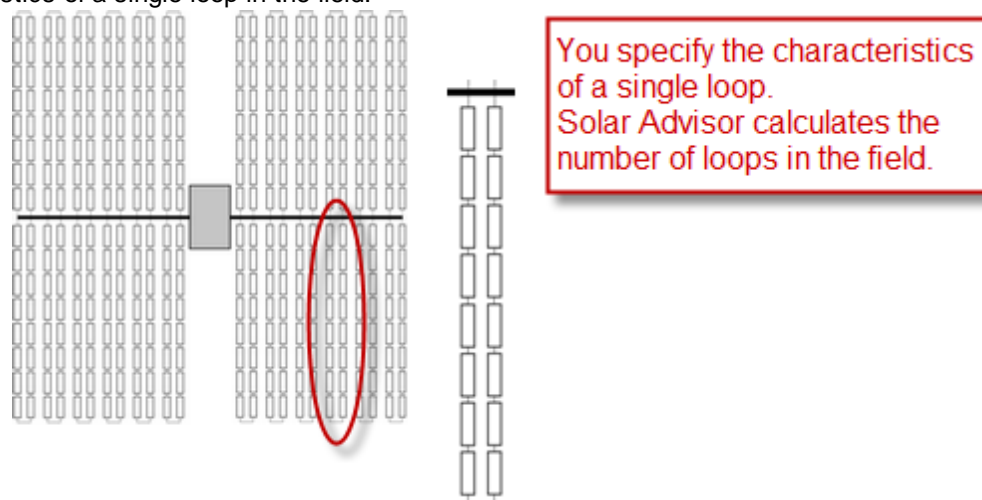
Click **Edit Defocus Order** to manually define the defocus order of the collectors in the field. Click an assembly to assign the defocus order. You should assign each collector a unique defocus order number. See [Defining Collector Defocusing](#) for details.

### Reset Defocus

Click to reset the defocus order to the default values, starting at the hot end of the loop and proceeding sequentially toward the cold end of the loop. See [Defining Collector Defocusing](#) for details.

## Specifying the Loop Configuration

The solar field consists of loops of collector-receiver assemblies. On the Solar Field page, you specify the characteristics of a single loop in the field.



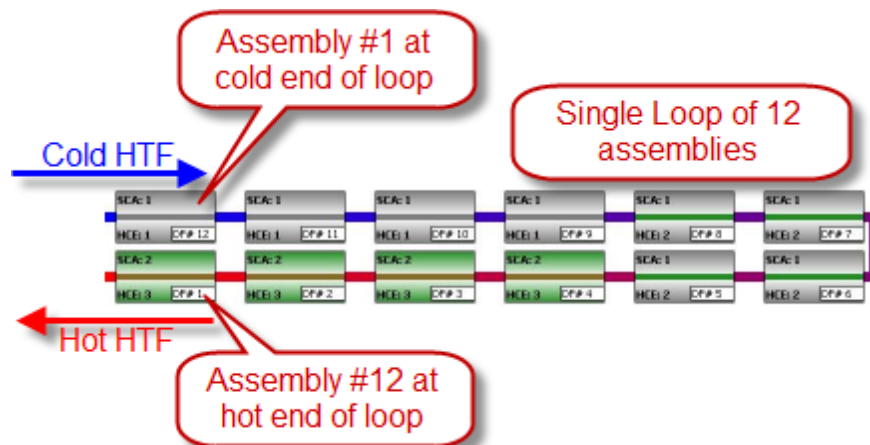
When you configure a loop, you specify the following characteristics using the single loop configuration diagram:

- Number of assemblies in a single loop.
- Collector (SCA) type of each assembly in the loop.
- Receiver (HCE) type of each assembly in the loop.
- Collector defocusing order, if applicable.

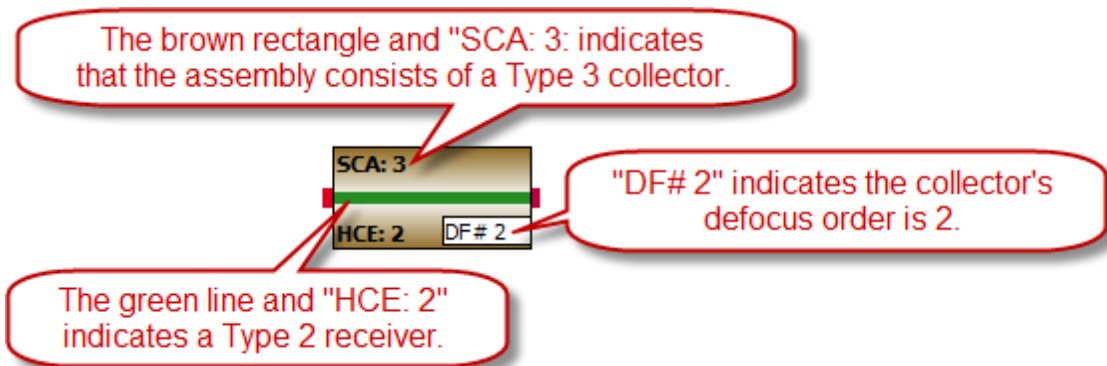
Each rectangle in the diagram represents a collector-receiver assembly. SAM allows you to specify a single loop of up to 35 collector-receiver assemblies, and up to four different receiver and collector types.

**Note.** It is not possible to specify more than one loop configuration. If your field consists of different types of collectors and receivers, you must represent the proportion of different types in a single loop.

Assembly #1, at the cold end of the loop, appears at the top left corner of the diagram. Depending on the collector defocusing option you use, you may need to know each assembly's number to assign a collector defocusing order. See [Defining Collector Defocusing](#) for details.



The color of the rectangle and SCA number indicates the collector type of each assembly. Similarly, the color of the line representing the receiver and the HCE number indicates the receiver type. The "DF" number indicates the collector defocusing order:



The characteristics of each collector type are defined on the [Collectors page](#), and of each receiver type on the [Receivers page](#).

#### **To specify the loop configuration:**

1. In Number of SCA/HCE assemblies per loop, type a number between 1 and 32. SAM displays a rectangle for each assembly in the loop.
2. If the loop has more than one type of collector, define each of up to four collector types on the [Collectors page](#). At this stage in your analysis, you can simply make note of the type number for each collector type you plan to include in the loop and define its characteristics on the Collectors page later.
3. Click **Edit SCAs**.
4. Use your mouse to select all of the collectors to which you want to assign a type number. You can use the Ctrl key to select individual collectors.



5. Use your keyboard to type the number corresponding to the collector's type number as defined on the Collectors page. SAM displays the collector (SCA) type number and color in the rectangle representing the collector type.
6. Repeat Steps 4-5 for each collector type in the loop.
7. If the loop includes more than one receiver type, click **Edit HCEs**, and follow Steps 4-6 for each receiver (HCE) type. You can define up to four receiver types on the [Receivers page](#).

## Defining Collector Defocusing

During hours when the solar field delivers more thermal energy than the power cycle (and thermal storage system, if available) can accept, or when the mass flow rate is higher than the maximum single loop flow rate defined on the Solar Field page, SAM defocuses collectors in the solar field to reduce the solar field thermal output. Mathematically, the model multiplies the radiation incident on the collector by a defocusing factor. In a physical system, the collector tracker would adjust the collector angle to reduce the amount of absorbed energy.

SAM provides three defocusing options:

- Option 1. No partial defocusing allowed: Collectors are either oriented toward the sun or in stow position. Collectors defocus in the order you specify. You should define a defocusing order as described below for this option.
- Option 2. Partial defocusing allowed with sequenced defocusing: Collectors can partially defocus by making slight adjustments in the tracking angle. Collectors defocus in the order you specify. You should define a defocusing order as described below for this option.
- Option 3. Partial defocusing allowed with simultaneous defocusing: Collectors can partially defocus by making slight adjustments in the tracking angle. All of the collectors in the field defocus by the same amount at the same time. You do not need to define a defocusing order for this option.

### To define collector defocusing option:

- In the Solar Field Parameters options, choose a defocusing option (see descriptions above):
  - Option 1: Clear **Allow partial defocusing**.
  - Option 2: Check **Allow partial defocusing**, and choose **Sequenced**.
  - Option 3: Check **Allow partial defocusing**, and choose **Simultaneous**.

If you choose Option 1 or Option 2, you should define the defocus order as described in the next procedure. If you choose Option 3, SAM ignores the defocusing order displayed in the single loop diagram.

### To define the defocus order:

1. If you choose Option 1 or 2 for the defocusing option, under Single Loop Configuration, click Edit Defocus Order.
2. Click each collector-receiver assembly in the loop, and type a number in the Defocus Order window. Assemblies are numbered starting at the top right corner of the diagram, at the cold end of the loop. Be sure to assign a unique defocus order number to each assembly.  
Click **Reset Defocus** if you want the defocus order to start at the hot end of the loop and proceed sequentially to the cold end of the loop.

### 18.5.3 Collectors (SCAs)

A collector (SCA, solar collector assembly) is an individually tracking component of the solar field that includes mirrors, a supporting structure, and receivers.

On the Collectors page, you can define the characteristics of up to four collector types. On the Solar Field page [single loop configuration](#), you specify how the different collector types are distributed in each loop of the field, assuming that the field consists of identical loops. SAM only uses data for collector types that you have included in the single loop configuration on the Solar Field page

**Note.** For a detailed explanation of the physical trough model, see Wagner, M. J.; Gilman, P. (2011). *Technical Manual for the SAM Physical Trough Model*. 124 pp.; NREL Report No. TP-5500-51825. <http://www.nrel.gov/docs/fy11osti/51825.pdf> (3.7 MB)

#### Collector Library

The physical trough model's collector [library](#) contains a set of collector parameters for several commercially available collectors. You can either use parameters from the library, or type your own parameter values.

##### To apply values from the library:

1. In the list of collectors at the top of the page, click a collector name. You can click a column heading to sort the list.
2. For the collector type to which you want to apply the parameters from the library, click **Apply Values from Library**. SAM will replace the collector geometry, and optical parameter values with values from the library.

You can modify the values after you apply the library values.

#### Collector Type and Configuration Name

##### Collector Type

Choose the active SCA type (1-4). SAM displays the properties of the active SCA type on the Collectors page. You can assign different properties to each of the up to four collector types. See [Specifying the Loop Configuration](#) for details on including different SCA types in the solar field.

##### Configuration Name

The name of library entry for the receiver type.

#### Collector Geometry

##### Reflective aperture area (m<sup>2</sup>)

The total reflective area of a single collector, used to calculate the loop aperture area of a loop, and number of loops required for a solar field with the aperture area defined on the [Solar Field page](#).

##### Aperture width, total structure (m)

The structural width of the collector, including reflective and non-reflective area. SAM uses this value to calculate row-to-row shadowing and blocking effects.

**Length of collector assembly (m)**

The length of a single collector assembly.

**Number of modules per assembly**

The number of individual collector-receiver sections in a single collector.

**Average surface-to-focus path length (m)**

The average distance between the collector surface and the focus of the parabola. This value is not equal to the focal length of the collector. To calculate the value when you know the focal length and aperture width, use the following equation, where  $F_{avg}$  is the average surface-to-focus path length:

$$F_{avg} = w \cdot \sqrt{\frac{\left(4 \cdot a^2 + \left(\frac{w}{2}\right)^2\right)^2}{a^2}} \cdot \frac{12 \cdot a^2 + \left(\frac{w}{2}\right)^2}{12 \cdot w \cdot \left(4 \cdot a^2 + \left(\frac{w}{2}\right)^2\right)}$$

Where  $a$  is the focal length at the vertex, and  $w$  is the aperture width

**Piping distance between assemblies (m)**

Length of pipes and hoses connecting collectors in a single row, not including the length of crossover pipes.

**Length of single module (m)**

The length of a single collector-receiver module, equal to the collector assembly length divided by the number of modules per assembly.

**Optical Parameters****Incidence angle modifier coefficients**

Coefficients for a polynomial equation defining the incidence angle modifier equation.

Click **Edit data** and to specify coefficients for the equation. The default coefficients are for an equation with three terms, but you can use the table to specify more coefficients.

The equation captures the degradation of collector performance as the incidence angle (theta) of the solar radiation increases.

During simulations, SAM limits the value of the incidence angle modifier that it calculates to values between 0 and 1, inclusive.

**Tracking error**

Accounts for reduction in absorbed radiation error in collectors tracking caused by poor alignment of sun sensor, tracking algorithm error, errors caused by the tracker drive update rate, and twisting of the collector end at the sun sensor mounting location relative to the tracking unit end.

**Geometry effects**

Accounts for errors in structure geometry caused by misaligned mirrors, mirror contour distortion caused by the support structure, mirror shape errors compared to an ideal parabola, and misaligned or distorted receiver.

**Mirror reflectance**

The mirror reflectance input is the solar weighted specular reflectance. The solar-weighted specular reflectance is the fraction of incident solar radiation reflected into a given solid angle about the specular

reflection direction. The appropriate choice for the solid angle is that subtended by the receiver as viewed from the point on the mirror surface from which the ray is being reflected. For parabolic troughs, typical values for solar mirrors are 0.923 (4-mm glass), 0.945 (1-mm or laminated glass), 0.906 (silvered polymer), 0.836 (enhanced anodized aluminum), and 0.957 (silvered front surface).

**Dirt on mirror**

Accounts for reduction in absorbed radiation caused by soiling of the mirror surface. This value is not linked to the mirror washing variables on the [Solar Field page](#).

**General optical error**

Accounts for reduction in absorbed radiation caused by general optical errors or other unaccounted error sources.

**Optical Calculations**

The optical calculations are values that SAM calculates using the equations described below. You cannot directly edit these values.

Variable Name	Equation	Note
Length of single module	$= \text{Length of Collector Assembly} \div \text{Number of Modules per Assembly}$	$L_{col}$ used in End Loss at Design described below.
Incidence angle modifier at summer solstice	$= IAM_0 + \sum_{i=1}^N IAM_i \frac{\theta^i}{\cos \theta}$	Not used in actual efficiency calculation. Provided as reference only. Theta is in radians.
End loss at summer solstice	$= 1 - L_{f,ave} * \tan(\theta) - \left(\frac{N_{SCA}}{2} - 1\right) * \frac{2 * EG}{N_{SCA} * L_{col}}$ where: $EG = L_{f,ave} * \tan(\theta) - L_{row\ spacing}$	Optical end loss at noon on the summer solstice due to reflected radiation spilling off of the end of the collector assembly. This value is provided as a reference and is not used in determining the design of the solar field.
Optical efficiency at design	$= \text{Tracking Error} \times \text{Geometry Effects on Mirror} \times \text{Mirror Reflectance} \times \text{Dirt} \times \text{General Optical Error}$	The collector's optical efficiency under design conditions.

## 18.5.4 Receivers (HCEs)

A receiver (HCE, heat collection element) is a metal pipe contained in a vacuum within glass tube that runs through the focal line of the trough-shaped parabolic collector. Seals and bellows ensure that a vacuum is maintained in each tube. Anti-reflective coatings on the glass tube maximize the amount of solar radiation that enters the tube. Solar-selective radiation absorbing coatings on the metal tube maximize the transfer of energy from the solar radiation to the pipe.

On the Receivers page, you define the characteristics of up to four receiver types. On the [Solar Field page](#), you specify how the different receiver types are distributed in each loop of the field, assuming that the field consists of identical loops. SAM only uses data for receiver types that you have included in the single loop specification on the Solar Field page.

For each receiver type, you also specify up to four variations. You can use the variations to describe different conditions of the receiver type. For example, you may use one variation to describe the receiver type in good condition, and another to describe the receiver type with a damaged glass envelope.

**Note.** For a detailed explanation of the physical trough model, see Wagner, M. J.; Gilman, P. (2011). *Technical Manual for the SAM Physical Trough Model*. 124 pp.; NREL Report No. TP-5500-51825. <http://www.nrel.gov/docs/fy11osti/51825.pdf> (3.7 MB)

### Receiver Library

The physical trough model's receiver [library](#) contains a set of collector parameters for several commercially available collectors. You can either use parameters from the library, or type your own parameter values.

#### To apply values from the library:

1. In the list of receivers at the top of the page, click a collector name. You can click a column heading to sort the list.
2. For the receiver type to which you want to apply the parameters from the library, click **Apply Values from Library**. SAM will replace the receiver geometry, and parameters and variations values from the library.

You can modify the values after you apply the library values.

### Receiver Type and Configuration Name

#### Receiver Type

Choose the active receiver type (1-4). SAM displays the properties of the active receiver.

#### Configuration Name

The name of library entry for the receiver type.

#### Apply Values from Library

Click the button to replace the receiver geometry and parameter and variations inputs with values from the current selection in the library.

## Receiver Geometry

### Absorber tube inner diameter (m)

Inner diameter of the receiver absorber tube, this surface in direct contact with the heat transfer fluid.

### Absorber tube outer diameter (m)

Outer diameter of the receiver absorber tube, the surface exposed to the annular vacuum.

### Glass envelope inner diameter (m)

Inner diameter of the receiver glass envelope tube, the surface exposed to the annular vacuum.

### Glass envelope outer diameter (m)

Outer diameter of the receiver glass envelope tube, the surface exposed to ambient air.

### Absorber flow plug diameter (m)

A non-zero value represents the diameter of an optional plug running axially and concentrically within the receiver absorber tube. A zero value represents a receiver with no plug. The plug allows for an increase in the receiver absorber diameter while maintaining the optimal heat transfer within the tube heat transfer fluid. For a non-zero value, be sure to use annular flow for the absorber flow pattern option.

### Internal surface roughness

The surface roughness of the inner receiver pipe surface exposed to the heat transfer fluid, used to determine flow shear force and the corresponding pressure drop across the receiver.

Surface roughness is important in determining the scale of the pressure drop throughout the system. As a general rule, the rougher the surface, the higher the pressure drop (and parasitic pumping power load). The surface roughness is a function of the material and manufacturing method used for the piping. A conservative roughness value for extruded steel pipe (the type often used for the absorber pipe) is about  $3\text{e-}6$  meters. The default value of  $4.5\text{e-}5$  is based on this value and the absorber tube inner diameter value of  $0.066\text{ m}$ :  $3\text{e-}6\text{ m} / 6.6\text{e-}2\text{ m} = 4.5\text{e-}5$ .

### Absorber flow pattern (m)

Use standard tube flow when the absorber flow plug diameter is zero. Use annular flow with a non-zero absorber flow plug diameter.

### Absorber material type

The material used for the absorber tube. Choose from stainless steel or copper.

## Parameters and Variations

### Variant weighting fraction

The fraction of the solar field that consists of the active receiver variation. For each receiver type, the sum of the four variations should equal one. See [Specifying Receiver Type Variations](#) for details.

### Absorber absorptance

The ratio of radiation absorbed by the absorber to the radiation incident on the absorber.

### Absorber emittance

The energy radiated by the absorber surface as a function of the absorber's temperature. You can either specify a table of emittance and temperature values, or specify a single value that applies at all temperatures.

**Envelope absorptance**

The ratio of radiation absorbed by the envelope to the radiation incident on the envelope, or radiation that is neither transmitted through nor reflected from the envelope. Used to calculate the glass temperature. (Does not affect the amount of radiation that reaches the absorber tube.)

**Envelope emittance**

The energy radiated by the envelope surface.

**Envelope transmittance**

The ratio of the radiation transmitted through the glass envelope to the radiation incident on the envelope, or radiation that is neither reflected nor refracted away from the absorber tube.

**Broken glass**

Option to specify that the envelope glass has been broken or removed, indicating that the absorber tube is directly exposed to the ambient air.

**Annulus gas type**

Gas type present in the annulus vacuum. Choose from Hydrogen, air, or Argon.

**Annulus pressure (torr)**

Absolute pressure of the gas in the annulus vacuum, in torr, where 1 torr = 133.32 Pa

**Estimated avg heat loss (W/m)**

An estimated value representing the total heat loss from the receiver under design conditions. SAM uses the value to calculate the total loop conversion efficiency and required solar field aperture area for the design point values on the [Solar Field page](#). It does not use the value in simulation calculations.

**Bellows shadowing**

An optical derate factor accounting for the fraction of radiation lost after striking the mechanical bellows at the ends of the receiver tubes.

**Dirt on receiver**

An optical derate factor accounting for the fraction of radiation lost due to dirt and soiling on the receiver.

**Total Weighted Losses**

The total weighted losses are used in the solar field sizing calculations as an estimate of the optical and thermal losses in the solar field at the design point. SAM does not use the weighted loss variables in hourly simulations.

**Heat loss at design**

The total thermal loss expected from the active receiver type under design conditions accounting for the weighting fraction of the four receiver variations. SAM uses the value to calculate the design point total loop conversion efficiency and the solar field aperture area shown on the [Solar Field page](#).

**Optical derate**

Represents the total optical losses expected from the active receiver type under design conditions accounting for the weighting fraction of the four receiver variations. SAM uses the value to calculate the design point total loop conversion efficiency and the solar field aperture area shown on the [Solar Field page](#).

**Variable****Equation****Note**

Heat loss at design

$$= \sum_{i=1}^4 f_{weight,i} * \dot{q}_{h,i}$$

$f_{weight,i}$  is the weighting fraction for each variation

Optical derate

$$= \sum_{i=1}^4 f_{weight,i} * \eta_{bellows,i} * \eta_{rec,dirt,i} * \eta_{absorb,i} * \tau_{env,i}$$

$\tau_{env,i}$  is the envelope transmittance

## Specifying Receiver Type Variations

You can use the receiver variations to model a solar field with receivers in different conditions. If you want all of the receivers in the field to be identical, then you can use a single variation and assign it a variant weighting fraction of 1.

When you use more than one receiver variation, be sure that the sum of the four variant weighting fractions is 1.

Here's an example of an application of the receiver variations for a field that consists of a two receiver types. The first type, Type 1, represents receivers originally installed in the field. Type 2 represents replacement receivers installed as a fraction of the original receivers are damaged over time.

Over the life of the project, on average, 5 percent of the Type 1 receivers have broken glass envelopes, and another 5 percent have lost vacuum in the annulus. We'll also assume that degraded receivers are randomly distributed throughout the field -- SAM does not have a mechanism for specifying specific locations of different variations of a given receiver type. To specify this situation, we would start with Type 1, and use Variation 1 to represent the 90 percent of intact receivers, assigning it a variant weighting fraction of 0.90. We'll use Variation 2 for the 5 percent of receivers with broken glass envelopes, giving it a weighting fraction of 0.05, and Variation 3 for the other 5 percent of lost-vacuum receivers with a weighting fraction of 0.05. We'll assign appropriate values to the parameters for each of the two damaged receiver variations.

Next, we'll specify Type 2 to represent intact replacement receivers. We will use a single variation for the intact Type 2 receivers.

On the Solar Field page, we'll specify the single loop configuration (assuming a loop with eight assemblies), using Type 2 for the first and second assembly in the loop, and Type 1 receivers (with the variant weighting we assigned on the Receivers page) for the remaining six assemblies in the loop

## 18.5.5 Power Cycle

The power cycle model for the SAM physical trough model is the same as that used for the [power tower](#) model. For a detailed description of the power cycle model, see Chapter 4 of Wagner M, 2008. *Simulation and Predictive Performance Modeling of Utility-Scale Central Receiver System Power Plants*. Master of Science Thesis. University of Wisconsin-Madison. <http://sel.me.wisc.edu/publications/theses/wagner08.zip>.

**Note.** For a detailed explanation of the physical trough model, see Wagner, M. J.; Gilman, P. (2011). *Technical Manual for the SAM Physical Trough Model*. 124 pp.; NREL Report No. TP-5500-51825. <http://www.nrel.gov/docs/fy11osti/51825.pdf> (3.7 MB)



## System Design Parameters

The system design parameters are from the [System Design](#) input page where you can set their values, and are shown for reference on the power cycle page.

### Power cycle gross output (MWe)

The power cycle's design output, not accounting for parasitic losses. SAM uses this value to size system components, such as the solar field area when you use the solar multiple to specify the solar field size. Also called design turbine gross output.

### Estimated gross to net conversion factor

An estimate of the ratio of the electric energy delivered to the grid to the power cycle's gross output. SAM uses the factor to calculate the power cycle's nameplate capacity for capacity-related calculations, including the estimated total cost per net capacity value on the [Trough System Costs page](#), capacity-based incentives on the [Incentives](#) page, and the capacity factor reported in the [results](#).

### Estimated net output (nameplate) (MWe)

The power cycle's nameplate capacity, calculated as the product of the design gross output and estimated gross to net conversion factor.

$$\text{Estimated Net Output at Design (MWe)} = \text{Design Gross Output (MWe)} \times \text{Estimated Gross to Net Conversion Factor}$$

### Cycle thermal efficiency

The thermal to electric conversion efficiency of the power cycle under design conditions

### Cycle thermal power, MWt

The power cycle thermal power input at design.

$$\text{Cycle Thermal Power, MWt} = \text{Design Turbine Gross Output (MWe)} \div \text{Cycle Thermal Efficiency}$$

### HTF hot temperature (°C)

The temperature of HTF at the loop inlet under design conditions. The actual temperature during operation may differ from this value. SAM sets the power cycle's design outlet temperature equal to this value.

### HTF cold temperature (°C)

The temperature of the HTF at the outlet of the loop under design conditions. During operation, the actual value may differ from this set point. This value represents the target temperature for control of the HTF flow through the solar field and will be maintained when possible.

## General Design Parameters

### Pumping power for HTF through power block (kW/kg/s)

A coefficient used to calculate the electric power required to pump heat transfer fluid through the power cycle. SAM applies the coefficient to all heat transfer fluid flowing through the power cycle. The coefficient can alternatively be defined as the pumping power divided by the mass flow rate kW/kg-s, which is equivalent to the units kJ/kg.

**Fraction of thermal power needed for standby**

The fraction of the power cycle's design thermal input required from storage to keep the power cycle in standby mode. This thermal energy is not converted into electric power. SAM does not calculate standby energy for systems with no storage.

**Power block startup time (hours)**

The time in hours that the system consumes energy at the startup fraction before it begins producing electricity. If the startup fraction is zero, the system will operate at the design capacity during the startup time.

**Fraction of thermal power needed for startup**

The fraction of the turbine's design thermal input energy required during startup. This thermal energy is not converted to electric power.

**Minimum turbine operation**

The fraction of the nameplate electric capacity below which the power block does not generate electricity. Whenever the power cycle output is below the minimum load and thermal energy is available from the solar field, the field is defocused. For systems with storage, solar field energy is delivered to storage until storage is full.

**Maximum turbine over design operation**

The maximum allowable power cycle output as a fraction of the electric nameplate capacity. Whenever storage is not available and the solar resource exceeds the irradiation at design value from the Solar Field page, some collectors in the solar field are defocused to limit the power block output to the maximum load.

**Cycle design HTF mass flow rate (kg/s)**

The HTF mass flow rate at the design point, and depends on the properties of the HTF.

$$\text{Cycle Design HTF Mass Flow Rate (kg/s)} = \frac{\text{Cycle Thermal Power (MW)} \times 1000 \text{ (kW/MW)}}{\text{Average HTF Specific Heat (kJ/kg}\cdot\text{K)} \times (\text{HTF Hot Temperature (}^\circ\text{C)} - \text{HTF Cold Temperature (}^\circ\text{C)})}$$

## Rankine Cycle Parameters

Page numbers relevant to this section from references cited with download links under "Power Tower" on the [CSP Publications](#) page of the SAM website:

- Wagner (2008) pp 83, 86, 114, 164
- Kistler (1986) p 224
- Hamilton (2020) p TBD

The power cycle page displays variables that specify the design operating conditions for the steam Rankine cycle used to convert thermal energy to electricity.

**Boiler operating pressure, Bar**

The saturation pressure of the steam as it is converted from liquid to vapor in the boiler or steam generator. SAM uses this value to determine the steam's saturation temperature and thus the superheating capability of the heat exchangers. The temperature difference that drives the steam mass flow rate in the Rankine cycle is the difference between the hot heat transfer fluid inlet temperature and the saturation temperature of the steam boiler pressure.

### Steam cycle blowdown fraction

The fraction of the steam mass flow rate in the power cycle that is extracted and replaced by fresh water. This fraction is multiplied by the steam mass flow rate in the power cycle for each hour of plant operation to determine the total required quantity of power cycle makeup water. The blowdown fraction accounts for water use related directly to replacement of the steam working fluid. The default value of 0.013 for the wet-cooled case represents makeup due to blowdown quench and steam cycle makeup during operation and startup. A value of 0.016 is appropriate for dry-cooled systems to account for additional wet-surface air cooling for critical Rankine cycle components.

### Turbine inlet pressure control

Determines the power cycle working fluid pressure during off-design loading.

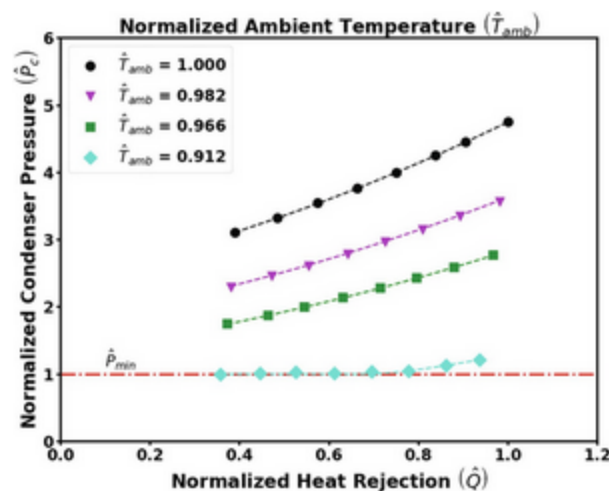
**Fixed Pressure:** The power block maintains the design high pressure of the power cycle working fluid during off-design loading.

**Sliding Pressure:** The power block decreases the high pressure of the power cycle working fluid during off-design loading.

### Condenser type

Choose either an air-cooled condenser (dry cooling), evaporative cooling (wet cooling), or hybrid cooling system.

The air-cooled condenser model utilizes a second-order bi-variate polynomial in terms of normalized ambient temperature and normalized heat rejection to determine normalized condenser pressure as shown in the graph below. Ambient temperature (converted to Kelvin) and heat rejection are normalized by their design conditions, while condenser pressure is normalized by the minimum condenser pressure. This model is valid for normalized ambient temperatures greater than 0.9. For conditions lower than this threshold, the condenser pressure is set to its minimum value.



In hybrid cooling, a wet-cooling system and dry-cooling share the heat rejection load. Although there are many possible theoretical configurations of hybrid cooling systems, SAM only allows a parallel cooling option.

Specify the hybrid cooling dispatch fractions on the [System Control](#) input age.

### Ambient temperature at design , °C

The ambient temperature at which the power cycle operates at its design-point-rated cycle conversion efficiency. For the air-cooled condenser option, use a dry bulb ambient temperature value. For the

evaporative condenser, use the wet bulb temperature.

**ITD at design point , °C**

For the air-cooled type only. Initial temperature difference (ITD), difference between the temperature of steam at the turbine outlet (condenser inlet) and the ambient dry-bulb temperature.

**Note.** When you adjust the ITD, you are telling the model the conditions under which the system will achieve the thermal efficiency that you've specified. If you increase the ITD, you should also modify the thermal efficiency (and/or the design ambient temperature) to accurately describe the design-point behavior of the system. The off-design penalty in the modified system will follow once the parameters are corrected.

**Reference condenser water dT, °C**

For the evaporative condenser type only. The temperature rise of the cooling water across the condenser under design conditions, used to calculate the cooling water mass flow rate at design, and the steam condensing temperature.

**Approach temperature, °C**

For the evaporative type only. The temperature difference between the circulating water at the condenser inlet and the wet bulb ambient temperature, used with the ref. condenser water dT value to determine the condenser saturation temperature and thus the turbine back pressure.

**Condenser Pressure Ratio**

For the air-cooled type only. The pressure-drop ratio across the air-cooled condenser heat exchanger, used to calculate the pressure drop across the condenser and the corresponding parasitic power required to maintain the air flow rate.

**Minimum condenser pressure**

The minimum condenser pressure in inches of mercury prevents the condenser pressure from dropping below the level you specify. In a physical system, allowing the pressure to drop below a certain point can result in physical damage to the system. For evaporative (wet cooling), the default value is 1.25 inches of mercury. For air-cooled (dry cooling), the default is 2 inches of mercury. For hybrid systems, you can use the dry-cooling value of 2 inches of mercury.

**Cooling system part load levels**

The cooling system part load levels tells the heat rejection system model how many discrete operating points there are. A value of 2 means that the system can run at either 100% or 50% rejection. A value of three means rejection operating points of 100% 66% 33%. The part load levels determine how the heat rejection operates under part load conditions when the heat load is less than full load. The default value is 2, and recommended range is between 2 and 10. The value must be an integer.

## User Defined Power Cycle

The user-defined power cycle model requires that you provide data from your own power cycle model describing the cycle's performance. If you do not have such data, you should use the Rankine cycle model.

If you are modeling a supercritical Carbon dioxide (sCO<sub>2</sub>) cycle, you can use the **sCO<sub>2</sub> Cycle Integration macro** with the [NREL Supercritical Carbon Dioxide \(sCO<sub>2</sub>\) Python model](#) to generate input data for the User Defined Power Cycle model

**Note.** The inputs for the table are normalized values, where 1 is the value at the design point.

The tables use the following shorthand:

- ? **cycle:** Power cycle gross output
- Heat in:** Cycle thermal input power
- ? **cooling:** Electrical consumption for cooling
- ? **water:** Water usage

You can import performance data into each table from a text file of comma-separated values with no headers. For example, the image below shows the first few rows of the performance table with the equivalent comma-separated data in a text file:

HTF Temp.	HTF m	Ambient Temp.	W cycle	Heat in	W cooling	m water
500	0.3	43	0.143233	0.221831	1	1
504.211	0.3	43	0.146807	0.226279	1	1
508.421	0.3	43	0.150404	0.230726	1	1
512.632	0.3	43	0.154022	0.235174	1	1

**Table of Performance Data in SAM**

```

1 500,0.3,43,0.143233,0.221831,1,1
2 504.211,0.3,43,0.146807,0.226279,1,1
3 508.421,0.3,43,0.150404,0.230726,1,1
4 512.632,0.3,43,0.154022,0.235174,1,1

```

**Equivalent Data in a Text File**

## User-defined Power Cycle Parameters

### Ambient temperature, °C

The outside air temperature at the design point.

### Cooling system water usage, kg/s

The cooling system water mass flow rate at the design point.

### Gross power consumed by cooling system, %

The electrical power consumed by the cooling system as a percentage of the power cycle gross output at the design point.

### Gross power consumed by cooling system, MWe

The cooling system gross power in megawatts of electricity, equal to the product of the gross cooling power percentage and the power cycle gross output at design.

## Performance as a Function of HTF Temperature, HTF Mass Flow Rate and Ambient Temperature

The performance as a function of hot HTF temperature, HTF mass flow rate and ambient temperature is defined in a single table that captures the relationships between these independent parameters and the 1)

cycle gross electrical output power, 2) thermal input power, 3) electrical consumption for cooling and 4) water mass flow rate.

Low, design, and high parameter values for input generation:

Low HTF temperature	<input type="text" value="500"/>	°C	Low normalized HTF m	<input type="text" value="0.3"/>	Low ambient temperature	<input type="text" value="0"/>	°C
Design HTF temperature	<input type="text" value="574.0"/>	°C	Design normalized HTF m	<input type="text" value="1.0"/>	Design ambient temperature	<input type="text" value="43.0"/>	°C
High HTF temperature	<input type="text" value="580"/>	°C	High normalized HTF m	<input type="text" value="1.2"/>	High ambient temperature	<input type="text" value="55"/>	°C
Number of levels	<input type="text" value="20"/>		Number of levels	<input type="text" value="20"/>	Number of levels	<input type="text" value="20"/>	

Generate Inputs	Import...	Export...	Copy	Paste	Rows: <input type="text" value="180"/>	
HTF Temp.	HTF m	Ambient Temp.	W cycle	Heat in	W cooling	m water
500	0.3	43	0.143233	0.221831	1	1
504.211	0.3	43	0.146807	0.226279	1	1
508.421	0.3	43	0.150404	0.230726	1	1
512.632	0.3	43	0.154022	0.235174	1	1

**Custom User-defined Power Cycle Performance Data Table**

The values in the table must be in accordance with the following structure but may be in any order:

Parametric Set	Number of Simulations	Custom Model Inputs		
		HTF Hot Temp	HTF Mass Flow Rate	Ambient Temperature
1	$N_{T_{HTF,hot}}$	$T_{HTF,hot}^i$ for $i = 1..N_{T_{HTF,hot}}$	$\dot{m}^-$	$T_{amb}^*$
2			$\dot{m}^*$	
3			$\dot{m}^+$	
4	$N_{\dot{m}}$	$T_{HTF,hot}^*$	$\dot{m}^i$ for $i = 1..N_{\dot{m}}$	$T_{amb}^-$
5				$T_{amb}^*$
6				$T_{amb}^+$
7	$N_{T_{HTF,amb}}$	$T_{HTF,hot}^-$	$\dot{m}^*$	$T_{amb}^i$ for $i = 1..N_{T_{amb}}$
8		$T_{HTF,hot}^*$		
9		$T_{HTF,hot}^+$		

**Custom Power Cycle Simulations Required to Populate SAM's Data Table**

To facilitate the parametric runs of the custom model, the three input parameters may be generated using the 'Generate Inputs' button. This populates the first three columns with values of the independent parameters that may be copied and used in the user's modeling software to generate the model outputs. This routine uses the Low, Design, and High values of the three independent parameters along with the desired number of respective levels.

**Low, design, and high HTF temperature**

The three hot HTF temperatures, where the design value is defined on the System Design page.

**Low, design, and high normalized HTF ?**

The three HTF mass flow rates, normalized to the design point (shown as Cycle design HTF mass flow rate under General Design Parameters above), where 1 is equivalent to the design point value.

**Low, design, and high ambient temperature**

The three ambient temperatures, where the design value is defined above under **User Defined Power Cycle Design Parameters**.

**Performance Table**

Columns 1 to 3 are the input parameters hot HTF temperature, HTF mass flow rate and ambient temperature.

Column 4 is the normalized cycle gross electrical output power.

Column 5 is the normalized thermal input power.

Column 6 is the normalized electrical consumption for cooling.

Column 7 is the water mass flow rate.

## 18.5.6 Thermal Storage

A thermal energy storage system (TES) stores heat from the solar field in a liquid medium. Heat from the storage system can drive the power block turbine during periods of low or no sunlight. A thermal storage system is beneficial in many locations where the peak demand for power occurs after the sun has set. Adding thermal storage to a parabolic trough system allows the collection of solar energy to be separated from the operation of the power block. For example, a system might be able to collect energy in the morning and use it to generate electricity late into the evening.

In direct storage systems, the solar field's heat transfer fluid itself serves as the storage medium. In indirect systems, a separate fluid is the storage fluid, and heat is transferred from the solar field's heat transfer fluid to the storage fluid through heat exchangers. The thermal storage system consists of one or more tank pairs, pumps to circulate the liquids, and depending on the design, heat exchangers. Each tank pair consists of a hot tank to store heat from the solar field, and a cold tank to store the cooled storage medium after the power block has extracted its energy.

The storage system variables describe the thermal energy storage system. The thermal storage dispatch control variables determine when the system dispatches energy from the storage system, and from a fossil-fired backup system if the system includes one.

**Note.** For a detailed explanation of the physical trough model, see Wagner, M. J.; Gilman, P. (2011). *Technical Manual for the SAM Physical Trough Model*. 124 pp.; NREL Report No. TP-5500-51825. <http://www.nrel.gov/docs/fy11osti/51825.pdf> (3.7 MB)

## System Design Parameters

The system design parameters are from the [System Design](#) input page where you can set their values, and are shown for reference on the power cycle page.

**Cycle thermal power, MWt**

The power cycle thermal power input at design.

**Hours of storage at design point (hours)**

The thermal storage capacity expressed in number of hours of thermal energy delivered at the design power cycle thermal power. The physical capacity is the number of hours of storage multiplied by the power cycle design thermal input. Used to calculate the thermal energy system's maximum storage capacity.

**Loop outlet HTF temperature (°C)**

The temperature of the HTF at the outlet of the loop under design conditions. During operation, the actual value may differ from this set point. This value represents the target temperature for control of the HTF flow through the solar field and will be maintained when possible.

**Loop inlet HTF temperature (°C)**

The temperature of HTF at the loop inlet under design conditions. The actual temperature during operation may differ from this value. SAM sets the power cycle's design outlet temperature equal to this value.

**Storage System****TES Thermal capacity (MWht)**

The equivalent thermal capacity of the storage tanks, assuming the thermal storage system is fully charged. This value does not account for losses incurred through the heat exchanger for indirect storage systems.

SAM calculates the total heat transfer fluid volume in storage based on the storage hours at full load and the power block design turbine thermal input capacity. The total heat transfer fluid volume is divided among the total number of tanks so that all hot tanks contain the same volume of fluid, and all cold tanks contain the same volume of fluid.

**Available HTF volume**

The total volume of storage fluid in both storage tanks.

SAM calculates the total heat transfer fluid volume in storage based on the storage hours at full load and the power block design turbine thermal input capacity. The total heat transfer fluid volume is divided among the total number of tanks so that all hot tanks contain the same volume of fluid, and all cold tanks contain the same volume of fluid.

**Tank height (m)**

The height of the cylindrical volume of heat transfer fluid in each tank.

**Tank fluid minimum height (m)**

The minimum allowable height of fluid in the storage tank(s). The mechanical limits of the tank determine this value.

**Storage tank volume (m<sup>3</sup>)**

The volume of the storage tank, calculated as follows where  $C$  is the TES thermal capacity

$$V_{TES} = \frac{C * 1e6 * 3600}{\rho_{HTF} * c_{htf} * 1000 * \mu_{hx} * ((T_{sf,out} - T_{hx,hot}) - (T_{sf,in} - T_{hx,cold}))}$$



$$C = \frac{\dot{W}_{des,gross}}{\eta_{des}} * t_{full\ load}$$

### Parallel tank pairs

The number of parallel hot-cold storage tank pairs. Increasing the number of tank-pairs also increases the volume of the heat transfer fluid exposed to the tank surface, which increases the total tank thermal losses. SAM divides the total heat transfer fluid volume among all of the tanks, and assumes that each hot tank contains an equal volume of fluid, and each cold tank contains an equal volume.

### Tank diameter (m)

The diameter of a storage tank, assuming that all tanks have the same dimensions. SAM calculates this value based on the specified height and storage volume of a single tank, assuming that all tanks have the same dimensions, as follows where  $h_{tank}$  is the tank height,  $N_{pairs}$  is the number of tank pairs,  $V_{TES}$  is the Storage Volume:

$$D_{tank} = 2 * \sqrt{\frac{V_{TES}}{h_{tank} * \pi * N_{pairs}}}$$

### Wetted loss coefficient (W/m<sup>2</sup>-K)

The thermal loss coefficient for the storage tanks. This value specifies the number of thermal watts lost from the tanks per square meter of tank surface area and temperature difference between the storage fluid bulk temperature and the ambient dry bulb temperature.

### Estimated heat loss (MWt)

The estimated value of heat loss from all storage tanks. The estimate assumes that the tanks are 50% charged, so that the storage fluid is evenly distributed among the cold and hot tanks, and that the hot tank temperature is equal to the solar field hot (outlet) temperature, and the cold tank temperature is equal to the solar field cold (inlet) temperature. Calculated as follows:

$$hl_{TES} = \left( h_{tank} * \pi * D_{tank} + \pi * \left( \frac{D_{tank}}{2} \right)^2 \right) * N_{pairs} * (T_{TES,avg} - 20) * C_{hl,tank}$$

### Pumping power for HTF through storage (kJ/kg)

A coefficient used to calculate the electric power consumed by pumps to move heat transfer fluid through the storage heat exchanger on both the solar field side and the storage tank side (for cases where a heat exchanger exists, specified on the [Thermal Storage](#) page). This coefficient is applied separately to the solar field flow and the tank flow.

### Initial hot HTF percent (%)

The fraction of the storage heat transfer fluid in the hot storage tank at the beginning of the simulation.

### Cold and hot tank heater set point (°C)

The minimum allowable storage fluid temperature in the storage tanks. If the fluid temperature falls below the set point, the electric tank heaters deliver energy to the tanks, attempting to increase the temperature to the set point. SAM reports this energy in the performance model results as "Tank freeze protection energy."

**Cold and hot tank tank heater capacity (MWt)**

The maximum rate at which heat can be added by the electric tank heaters to the storage fluid in the tanks.

**Tank heater efficiency**

The electrical to thermal conversion efficiency of the electric tank heaters.

**Storage HTF fluid**

The storage fluid used in the thermal energy storage system.

When the storage fluid and solar field heat transfer fluid (HTF) are different, the system is an indirect system with a heat exchanger (heat exchanger derate is less than one).

When the storage fluid and solar field HTF are the same, the system is a direct system that uses the solar field HTF as the storage medium. For a direct system, SAM disables the **Hot side HX approach temp** and **Cold side HX approach temp** variables, and sets the **Heat exchanger derate** value to one. See the [Solar Field](#) page for table of fluid properties.

**User-defined HTF fluid**

When you choose user-defined from the Storage HTF fluid list, you can specify a table of material properties of a storage fluid. You must provide values for two temperatures (two rows of data) of specific heat, density, viscosity, and conductivity values. See [Custom HTF](#) for details.

**HTF density (kg/m<sup>3</sup>)**

The density of the storage fluid at the fluid temperature, used to calculate the total mass of thermal fluid required in the storage system.

**Storage HTF min operating temp (°C)**

The minimum HTF operating temperature recommended by the HTF manufacturer.

In some cases the minimum operating temperature may be the same as the fluid's freeze point. However, at the freeze point the fluid is typically significantly more viscous than at design operation temperatures, so it is likely that the "optimal" minimum operating temperature is higher than the freeze point.

**Storage HTF max operating temp (°C)**

The minimum HTF operating temperature recommended by the HTF manufacturer.

Operation at temperatures above this value may result in degradation of the HTF and be unsafe. To avoid this, you may want to include a safety margin and use a maximum operating temperature value slightly lower than the recommended value.

**Notes.**

SAM displays the operating temperature limits for your reference so you can compare them to the storage temperatures reported in the results to ensure that they do not exceed the limits. SAM does not adjust the system's performance to avoid exceeding these operating limits.

SAM only displays these limits for fluids that are in SAM's library. If you use a custom HTF instead of one from the SAM library, SAM disables the HTF operating temperature limits. In this case, you should use data from the fluid manufacturer specifications.

**Hot side HX approach temp (°C)**

Applies to systems with a heat exchanger only (indicated by a heat exchanger derate value of less than one). The temperature difference on the hot side of the solar-field-to-thermal-storage heat exchanger. During charge cycles, the temperature is the solar field hot outlet temperature minus the storage hot tank inlet temperature. During discharge cycles, it is defined as the storage hot tank temperature minus the power cycle hot inlet temperature.

**Cold side HX approach temp (°C)**

Applies to systems with a heat exchanger only (indicated by a heat exchanger derate value less than one). The temperature difference on the cold side of the solar field-to-thermal-storage heat exchanger. During charge cycles, the temperature is the storage cold temperature (storage outlet) minus the heat exchanger cold temperature. During discharge cycles, it is the heat exchanger cold temperature minus the storage cold temperature (storage inlet).

## 18.5.7 System Control

The System Control inputs determine the operating parameters of the system.

**Note.** The physical trough and molten salt power tower models in SAM use a new power cycle and system dispatch model that does not support thermocline storage or fossil backup because they were not incorporated into the new dispatch controller logic. If you want to use those features, you can use the legacy version SAM 2015.6.30, available on the SAM website [Download page](#).

### Plant Energy Consumption

**Fraction of gross power consumed at all times, MWe/MWcap**

A fixed electric load applied to all hours of the simulation, expressed as a fraction of rated gross power at design from the [System Design](#) page.

**Balance of Plant Parasitic, MWe/MWcap**

Losses as a fraction of the power block nameplate capacity that apply in hours when the power block operates.

**Aux heater boiler parasitic (MWe/MWcap)**

A parasitic load that is applied as a function of the thermal output of the auxiliary fossil-fired heaters.

The BOP and auxiliary heater parasitic at design are calculated as follows:

$$\text{Parasitic Loss (MWe)} = P \text{ (MWe/MWcap)} \times F \times (C0 + C1 + C2) \times \text{Design Turbine Gross Output (MWe)}$$

### System Availability

System availability losses are reductions in the system's output due to operational requirements such as maintenance down time or other situations that prevent the system from operating as designed.

**Note.** To model curtailment, or forced outages or reduction in power output required by the grid operator, use the inputs on the [Grid Limits](#) page.

To edit the system availability losses, click **Edit losses**.

The [Edit Losses](#) window allows you to define loss factors as follows:

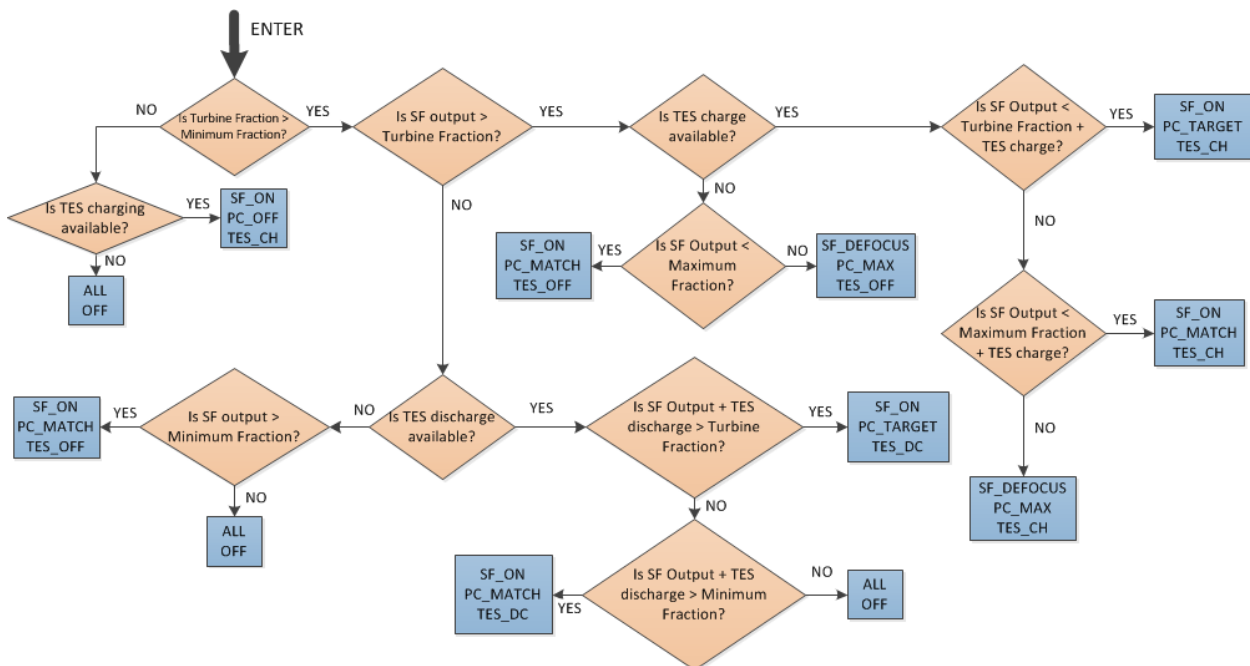
- Constant loss is a single loss factor that applies to the system's entire output. You can use this to model an availability factor.
- Hourly losses apply to specific hours of the year.

SAM reduces the system's output in each hour by the loss percentage that you specify for that hour. For a given hour, a loss of zero would result in no adjustment. A loss of 5% would reduce the output by 5%, and a loss of -5% would increase the output value by 5%. For subhourly simulations, SAM applies the loss factor for a given hour to each time step in that hour

### Dispatch Optimization

The dispatch algorithm determines the timing of energy delivery from the solar field and to and from the thermal energy storage system. When the field is producing more thermal power than required by the power cycle during times when storage is full, the algorithm defocuses heliostats in the field to reduce the field output power. SAM reports the field optical focus fraction fraction, receiver incident thermal power, TES charge state, and other variables in the [Results](#) that you can use to see how the system operates.

When you enable dispatch optimization, SAM automatically determines when the system defocuses heliostats in the field, stores thermal energy from the solar field, or when it dispatches thermal energy from the thermal energy storage system to the power cycle.



When you run a simulation without enabling optimization, SAM attempts to operate the system so that the power cycle output matches the dispatch schedule you define. If the turbine dispatch fraction for a given time step is greater than the minimum turbine fraction and the storage system is full, it will dispatch energy

to the power cycle up to the turbine output fraction for that time step, and defocus the field if the field thermal power output exceeds the amount required.

**Enable dispatch optimization**

Check the box to enable automatic optimization.

**Time horizon for dispatch optimization**

The time period that SAM uses as a basis for the optimization. Default value is 48 hours.

**Frequency for dispatch reoptimization**

The time period to determine how often SAM runs the optimization. Default value is 24 hours.

**Cycle startup cost penalty, \$/start**

The penalty in the dispatch optimization algorithm associated with starting up the power cycle. The cost is applied any time the power cycle goes from an “off” state to an “on” or “standby” state in the next time period. This penalty affects the optimal solution, which seeks to maximize revenue. This value *does not* affect actual O&M costs or the calculated SAM financial metrics.

**Receiver startup cost penalty, \$/start**

The penalty in the dispatch optimization algorithm associated with starting up the solar field and receiver. The cost is applied any time the solar field goes from an “off” state to an “on” state in the next time period. This penalty affects the optimal solution, which seeks to maximize revenue. This value *does not* affect actual O&M costs or the calculated SAM financial metrics.

**Power generation ramping penalty**

The penalty imposed for changing power cycle electrical production from one time step to the next. By penalizing changes, the resulting dispatch profile exhibits improved stability and is potentially more realizable in practice. Increasing this penalty may reduce achieved revenue for the project. This penalty affects the optimal solution, which seeks to maximize revenue. This value does not affect actual O&M costs or the calculated SAM financial metrics.

**Objective function time weighting exponent**

The relative weight due to time in the dispatch optimization objective function. A weighting factor of 0.99 indicates that the objective function terms are multiplied by  $0.99^t$  for each timestep  $t$  in the optimization horizon (48 hours, by default). A value of 1.0 indicates no time weighting, a value less than one indicates that – all things equal – generation is preferred sooner than later, and a value greater than one indicates that generation is preferred later than sooner. As the value is displaced from unity, the optimization algorithm is typically able to solve the dispatch problem more quickly, but the resulting revenue may decrease. Note that a value of 0.99 corresponds to an objective discounting in the 24th time period (one day ahead) of  $0.99^{24} = 0.79$ , which is to say that the optimization routine values revenue generated in hour one 21% more than in hour 24, though revenue multipliers and efficiency terms may be identical.

**Maximum branch and bound iterations**

Limits the number of iterations in the optimization routine. If you are experiencing problems with the optimization, you can increase the number. The default value is 30,000.

**Solution optimality gap tolerance**

Determines the tolerance for the optimization solution. You can decrease the tolerance if you are experiencing problems with the optimization. Default value is 0.001.

**Optimization solver timeout limit, seconds**

Limits the amount of time the optimization will attempt to find a solution. You can increase the timeout

limit if you are experiencing problems with the optimization. Default value is 5 seconds.

### **Max. net power to the grid (MWe)**

The maximum allowable net power to the grid when running dispatch optimization. Use a value much greater than the power cycle nameplate capacity to remove the effect of this constraint.

SAM determines approximate parasitic loads and the approximate gross cycle generation at each time period in the forecast horizon, and limits the net output to be less than or equal to this value. If the net power production cannot reach the specified limit, either because insufficient energy is available for power generation or because the power cycle operation envelope does not allow for sufficiently high output, the constraint will not be applied.

### **Max. net power to the grid (incl. availability), MWe**

A calculated value that indicates the max. net power to the grid after power cycle availability losses are accounted for. The calculated value is the product of the max.net power to the grid and the constant term in the [Edit Losses](#) window on the System Control page. Note that hourly or hourly-block availability options are not included in this calculation, and only the constant is considered. When running a simulation with dispatch optimization enabled and the maximum power constraint in effect, the net production in the hourly data viewer will most closely equal this calculated value.

## **Dispatch Control**

The dispatch control periods determine the timing of adjustments to the power cycle output.

**Note.** If your analysis involves PPA price multipliers defined on the [Time of Delivery \(TOD\) Factors](#) page, you should verify that the dispatch control schedules are consistent with the TOD factor schedules.

### **Use output fraction as maximum cycle output**

Check this box if you want to limit the power cycle output to the turbine output fraction you specify for dispatch control instead of the **Maximum turbine over design operation** on the Power Cycle page. If you do not check the box and the turbine over design operation is greater than the highest turbine output fraction, the power cycle may operate at the higher value, exceeding the maximum dispatch limit under some conditions.

### **Turbine output fraction**

For each of up to nine time-of-delivery periods, specify a multiple of the power cycle thermal input to scale the system's electrical output up or down as desired to match power pricing schedules or other time-dependent constraints.

### **Hybrid cooling fraction**

For each of up to nine time-of-delivery periods, specify how much of the cooling load should be handled by the wet-cooling system. Each value in the table is a fraction of the design cooling load. For example, if you want 60% of heat rejection load to go to wet cooling in Period 1, type 0.6 for Period 1. Directing part of the heat rejection load to the wet cooling system reduces the total condenser temperature and improves performance, but increases the water requirement. SAM sizes the wet-cooling system to match the maximum fraction that you specify in the hybrid dispatch table, and sizes the air-cooling system to meet the full cooling load.

## **Defining Dispatch Schedules**

The storage dispatch schedules determine when each of the nine periods apply during weekdays and weekends throughout the year.

If your analysis includes [PPA price multipliers](#) and you want to use the same schedule for the multipliers and for the power cycle dispatch control, click **Copy schedule from TOD Factors** page to apply the TOD Factors schedule matrices to the dispatch schedule matrices.

**To specify a weekday or weekend schedule:**

1. Assign values as appropriate to the **Turbine output fraction** and **Hybrid cooling fraction** for each of the up to nine periods.
2. Use your mouse to draw a rectangle in the matrix for the first block of time that applies to period 2.

	12am	1am	2am	3am	4am	5am	6am	7am	8am	9am	10am	11am	12pm	1pm	2pm	3pm	4pm	5pm	6pm	7pm	8pm	9pm	10pm	11pm
Jan	1	1	1	1	1	1	1	1	1	1	1	1	1	1	1	1	1	1	1	1	1	1	1	1
Feb	1	1	1	1	1	1	1	1	1	1	1	1	1	1	1	1	1	1	1	1	1	1	1	1
Mar	1	1	1	1	1	1	1	1	1	1	1	1	1	1	1	1	1	1	1	1	1	1	1	1
Apr	1	1	1	1	1	1	1	1	1	1	1	1	1	1	1	1	1	1	1	1	1	1	1	1
May	1	1	1	1	1	1	1	1	1	1	1	1	1	1	1	1	1	1	1	1	1	1	1	1
Jun	1	1	1	1	1	1	1	1	1	1	1	1	1	1	1	1	1	1	1	1	1	1	1	1
Jul	1	1	1	1	1	1	1	1	1	1	1	1	1	1	1	1	1	1	1	1	1	1	1	1
Aug	1	1	1	1	1	1	1	1	1	1	1	1	1	1	1	1	1	1	1	1	1	1	1	1
Sep	1	1	1	1	1	1	1	1	1	1	1	1	1	1	1	1	1	1	1	1	1	1	1	1
Oct	1	1	1	1	1	1	1	1	1	1	1	1	1	1	1	1	1	1	1	1	1	1	1	1
Nov	1	1	1	1	1	1	1	1	1	1	1	1	1	1	1	1	1	1	1	1	1	1	1	1
Dec	1	1	1	1	1	1	1	1	1	1	1	1	1	1	1	1	1	1	1	1	1	1	1	1

3. Type the number 2.

	12am	1am	2am	3am	4am	5am	6am	7am	8am	9am	10am	11am	12pm	1pm	2pm	3pm	4pm	5pm	6pm	7pm	8pm	9pm	10pm	11pm
Jan	1	1	1	1	1	1	1	1	1	1	1	1	1	1	1	1	1	1	1	1	1	1	1	1
Feb	1	1	1	1	1	1	1	1	1	1	1	1	1	1	1	1	1	1	1	1	1	1	1	1
Mar	1	1	1	1	1	1	1	1	1	1	1	1	1	1	1	1	1	1	1	1	1	1	1	1
Apr	1	1	1	1	1	1	1	1	1	1	1	1	1	1	1	1	1	1	1	1	1	1	1	1
May	1	1	1	1	1	1	1	1	1	1	2	2	2	2	2	2	1	1	1	1	1	1	1	1
Jun	1	1	1	1	1	1	1	1	1	1	2	2	2	2	2	2	1	1	1	1	1	1	1	1
Jul	1	1	1	1	1	1	1	1	1	1	2	2	2	2	2	2	1	1	1	1	1	1	1	1
Aug	1	1	1	1	1	1	1	1	1	1	2	2	2	2	2	2	1	1	1	1	1	1	1	1
Sep	1	1	1	1	1	1	1	1	1	1	1	1	1	1	1	1	1	1	1	1	1	1	1	1
Oct	1	1	1	1	1	1	1	1	1	1	1	1	1	1	1	1	1	1	1	1	1	1	1	1
Nov	1	1	1	1	1	1	1	1	1	1	1	1	1	1	1	1	1	1	1	1	1	1	1	1
Dec	1	1	1	1	1	1	1	1	1	1	1	1	1	1	1	1	1	1	1	1	1	1	1	1

4. SAM shades displays the period number in the squares that make up the rectangle, and shades the rectangle to match the color of the period.

**Dispatch Control**

[Copy schedule from TOD Factors page](#)

Use the schedule matrices to specify the month and hour of day for each of the nine periods.

**Turbine output fraction**

Period 1:

Period 2:

Period 3:

Period 4:

Period 5:

Period 6:

Period 7:

Period 8:

Period 9:

The turbine output fraction scales the turbine thermal input relative to design for the corresponding time-of-use period.

**Weekday Schedule**

	12am	1am	2am	3am	4am	5am	6am	7am	8am	9am	10am	11am	12pm	1pm	2pm	3pm	4pm	5pm	6pm	7pm	8pm	9pm	10pm	11pm
Jan	1	1	1	1	1	1	1	1	1	1	1	1	1	1	1	1	1	1	1	1	1	1	1	1
Feb	1	1	1	1	1	1	1	1	1	1	1	1	1	1	1	1	1	1	1	1	1	1	1	1
Mar	1	1	1	1	1	1	1	1	1	1	1	1	1	1	1	1	1	1	1	1	1	1	1	1
Apr	1	1	1	1	1	1	1	1	1	1	1	1	1	1	1	1	1	1	1	1	1	1	1	1
May	1	1	1	1	1	1	1	1	1	1	1	1	2	2	2	2	2	1	1	1	1	1	1	1
Jun	1	1	1	1	1	1	1	1	1	1	1	1	2	2	2	2	2	1	1	1	1	1	1	1
Jul	1	1	1	1	1	1	1	1	1	1	1	1	2	2	2	2	2	1	1	1	1	1	1	1
Aug	1	1	1	1	1	1	1	1	1	1	1	1	2	2	2	2	2	1	1	1	1	1	1	1
Sep	1	1	1	1	1	1	1	1	1	1	1	1	1	1	1	1	1	1	1	1	1	1	1	1
Oct	1	1	1	1	1	1	1	1	1	1	1	1	1	1	1	1	1	1	1	1	1	1	1	1
Nov	1	1	1	1	1	1	1	1	1	1	1	1	1	1	1	1	1	1	1	1	1	1	1	1
Dec	1	1	1	1	1	1	1	1	1	1	1	1	1	1	1	1	1	1	1	1	1	1	1	1

5. Repeat Steps 2-4 for each of the remaining periods that apply to the schedule.

## Operating Modes

The power tower model reports a set of operating mode outputs indicating how the system operates in each time step. The controller may divide a time step into different operating modes. For example the startup time step may involve three operating modes: Operating Mode 2 as the receiver warms up and the power cycle is off, followed by Operating Mode 32 when the receiver is on and hot HTF is delivered to both the power cycle for startup and TES, and then by Operating Mode 11 when the receiver is on and hot HTF is delivered to both the power cycle for power generation and TES for charging. The controller reports the first three operating modes and the number of modes for each time step. Most time steps will require three or fewer modes. In some rare cases, a time step may require more than three modes.

The operating modes output variables are:

### 1st operating mode

The operating mode at the beginning of the time step.

### 2nd op. mode, if applicable

If the operating mode changes within the time step, the second operating mode follows the first operating mode.

### 3rd op mode, if applicable

If the operating mode changes three times within the time step, the third operating mode follows the second operating mode.

### Operating modes in reporting timestep

The number of operating modes in a given time step.

In each time step, the power tower plant controller uses an iterative process to search for the operating mode that best achieves target plant output. The target plant output is either determined from the **Turbine output fraction** for the time step that you specify under **Dispatch Control**, or, if you check **Enable dispatch optimization** under **Dispatch Optimization**, it is automatically optimized. For example, for a time step when the receiver output power is very close to but slightly less than the thermal power required for the power cycle to generate power at the target level, the controller might try Operating Mode 11 where the receiver delivers hot HTF to both the power cycle and TES and determine that is not enough energy to



meet the cycle target. The controller would then it try Operating Mode 12 that discharges a small amount of energy from TES to supplement the energy from the receiver and meet the cycle target. If the cycle target is met, the **First 3 operating modes tried** would be 1112 to represent the controller trying Operating Mode 11 followed by Operating Mode 12.

In most cases, the controller will only need to consider up to three attempts, and it reports up to nine attempts. The output variables indicating operating modes considered by the controller are listed below. Note that modes 1-9 are indicated as 10, 20, 30, ... 90.

**First 3 operating modes tried**

The numbers of the first of up to three operating modes tested in a given time step to find the best operating mode. For example, if operating modes 11 and 12 were tried, the value would be 1112.

**Next 3 operating modes tried**

If the controller tried more than three operating modes, the mode numbers up to three additional attempts.

**Final 3 operating modes tried**

If the controller tried more than six operating modes, the mode numbers for up to three additional attempts.

The 34 operating modes are described in the table below. Note that single digit operating modes 1-9 are shown as 10, 20, etc. in the "operating modes tried" variables.

Operating Mode	Description
1 (10)	CR_OFF, PC_OFF, TES_OFF, AUX_OFF
2 (20)	CR_SU, PC_OFF, TES_OFF, AUX_OFF
3 (30)	CR_ON, PC_SU, TES_OFF, AUX_OFF
4 (40)	CR_ON, PC_SB, TES_OFF, AUX_OFF
5 (50)	CR_ON, PC_RM_HI, TES_OFF, AUX_OFF
6 (60)	CR_ON, PC_RM_LO, TES_OFF, AUX_OFF
7 (70)	CR_DF, PC_MAX, TES_OFF, AUX_OFF
8 (80)	CR_OFF, PC_SU, TES_DC, AUX_OFF
9 (90)	CR_ON, PC_OFF, TES_CH, AUX_OFF
10	SKIP_10 (not used)
11	CR_ON, PC_TARGET, TES_CH, AUX_OFF
12	CR_ON, PC_TARGET, TES_DC, AUX_OFF
13	CR_ON, PC_RM_LO, TES_EMPTY, AUX_OFF
14	CR_DF, PC_OFF, TES_FULL, AUX_OFF
15	CR_OFF, PC_SB, TES_DC, AUX_OFF
16	CR_OFF, PC_MIN, TES_EMPTY, AUX_OFF
17	CR_OFF, PC_RM_LO, TES_EMPTY, AUX_OFF
18	CR_ON, PC_SB, TES_CH, AUX_OFF
19	CR_SU, PC_MIN, TES_EMPTY, AUX_OFF
20	SKIP_20 (not used)
21	CR_SU, PC_SB, TES_DC, AUX_OFF
22	CR_ON, PC_SB, TES_DC, AUX_OFF
23	CR_OFF, PC_TARGET, TES_DC, AUX_OFF
24	CR_SU, PC_TARGET, TES_DC, AUX_OFF
25	CR_ON, PC_RM_HI, TES_FULL, AUX_OFF
26	CR_ON, PC_MIN, TES_EMPTY, AUX_OFF
27	CR_SU, PC_RM_LO, TES_EMPTY, AUX_OFF
28	CR_DF, PC_MAX, TES_FULL, AUX_OFF
29	CR_ON, PC_SB, TES_FULL, AUX_OFF
30	SKIP_30 (not used)
31	CR_SU, PC_SU, TES_DC, AUX_OFF
32	CR_ON, PC_SU, TES_CH, AUX_OFF
33	CR_DF, PC_SU, TES_FULL, AUX_OFF
34	CR_DF, PC_SU, TES_OFF, AUX_OFF

## 18.5.8 Script-only Parameters

The parameters described in this section can only be accessed using SAM's LK scripting language and are useful for modeling design details and configurations that are not available from the input pages in SAM's user interface.

For more about the LK scripting language, see [Macros and Scripting](#).

For a sample script illustrating how to set some of these script-only parameters, see the [molten salt trough.lk](#) file in the SAM Open Source repository on GitHub.com.

### Field Parameters

#### **custom\_sf\_pipe\_sizes [-]**

Whether the header and runner diameters, wall thicknesses and lengths should be calculated or input from the parameters:

- sf\_hdr\_diams
- sf\_hdr\_lengths
- sf\_hdr\_wallthicks
- sf\_rnr\_diams
- sf\_rnr\_lengths
- sf\_rnr\_wallthicks

If this parameter value is true the above values are input; if this parameter value is false the values are calculated. The default value is false.

#### **L\_rnr\_per\_xpan [m]**

The maximum length of straight runner pipe without an expansion loop. Beyond this length an expansion loop is added (without increasing the linear distance). The default value is 70 m.

#### **L\_xpan\_hdr [m]**

The additional pipe length that an expansion loop in a header adds. The default value is 20 m.

#### **L\_xpan\_rnr [m]**

The additional pipe length that an expansion loop in a runner adds. The default value is 20 m.

#### **Min\_rnr\_xpans [-]**

The minimum number of expansion loops in any constant diameter runner pipe section, enforced during pipe sizing. The default value is 1.

#### **N\_hdr\_per\_xpan [m]**

The number of collector loops per header expansion loop. A value of 1 means that there are expansion loops between every collector loop. The default value is 2.

#### **N\_max\_hdr\_diams [-]**

The maximum number of different header pipe diameters in either the cold or hot legs, enforced during pipe sizing. The default value is 10.

**northsouth\_field\_sep [m]**

The distance separating subfields in the north-south direction. If the value is zero, the solar collector assemblies are touching. The default value is 20 m.

**offset\_xpan\_hdr [-]**

The location of the first header expansion loop. A value of 1 means that the first expansion loop is after the first collector loop closest to the runner. The default value is 1.

**sf\_hdr\_diams [m]**

The custom specified header section inside diameters. The values are utilized if the parameter `custom_sf_pipe_sizes` is set to true. The number of header diameter values needs to match the number of header sections.

**sf\_hdr\_lengths [m]**

The custom specified header section lengths. The values are utilized if the parameter `custom_sf_pipe_sizes` is set to true. The number of header length values needs to match the number of header sections.

**sf\_hdr\_wallthicks [m]**

The custom specified header section wall thicknesses. The values are utilized if the parameter `custom_sf_pipe_sizes` is set to true. The number of header wall thickness values needs to match the number of header sections.

**sf\_rnr\_diams [m]**

The custom specified runner section inside diameters. The values are utilized if the parameter `custom_sf_pipe_sizes` is set to true. The number of runner diameter values needs to match the number of runner sections.

**sf\_rnr\_lengths [m]**

The custom specified runner section lengths. The values are utilized if the parameter `custom_sf_pipe_sizes` is set to true. The number of runner length values needs to match the number of runner sections.

**sf\_rnr\_wallthicks [m]**

The custom specified runner section wall thicknesses. The values are utilized if the parameter `custom_sf_pipe_sizes` is set to true. The number of runner wall thickness values needs to match the number of runner sections.

## Thermal Energy Storage/ Power Block Parameters

**custom\_sgs\_pipe\_sizes [-]**

Whether the thermal energy storage and power block pipe diameters and wall thicknesses should be calculated or input from the parameters:

- `sgs_diams`
- `sgs_wallthicks`

If this parameter value is true the above values are input; if this parameter value is false the values are calculated. Note that the lengths are always input. The default value is false.

**custom\_tes\_p\_loss [-]**

Whether the pressure drops in the thermal energy storage system should be calculated using the associated pipe lengths and minor loss coefficients (`k_tes_loss_coefs`) or using the pumping power parameters on the Parasitics page. The default value is false.

**DP\_SGS [bar]**

The combined pressure drop within the steam generator system. The default value is 0 bar.

**has\_hot\_tank\_bypass [-]**

The indicator that specifies the outlet of the solar field bypass pipe. The solar field heat transfer fluid is routed back to the field when the heat transfer fluid is below a specified temperature. If this value is true, the fluid from the field is routed to the cold thermal storage tank. If this value is false, the fluid is routed to the field inlet runners. The default value is false.

**k\_tes\_loss\_coefs [-]**

The combined minor loss coefficients for each section of pipe in the thermal energy storage and power block systems. One coefficient corresponds to each pipe section, where each is an additive combination of the minor loss coefficients of the fittings in that section. These minor loss coefficients (`k`) are used in the following equation to calculate the pressure drop in the corresponding pipe that is caused by the fittings, where `U` is the velocity of the heat transfer fluid and `ρ` is the fluid density. The default values are all zeroes.

$$\Delta P = \frac{1}{2} \cdot k \cdot U^2 \cdot \rho$$

**L\_rnr\_pb [m]**

The length of runner pipe in and around the power block, for either the hot or cold lines. The default value is 25 m.

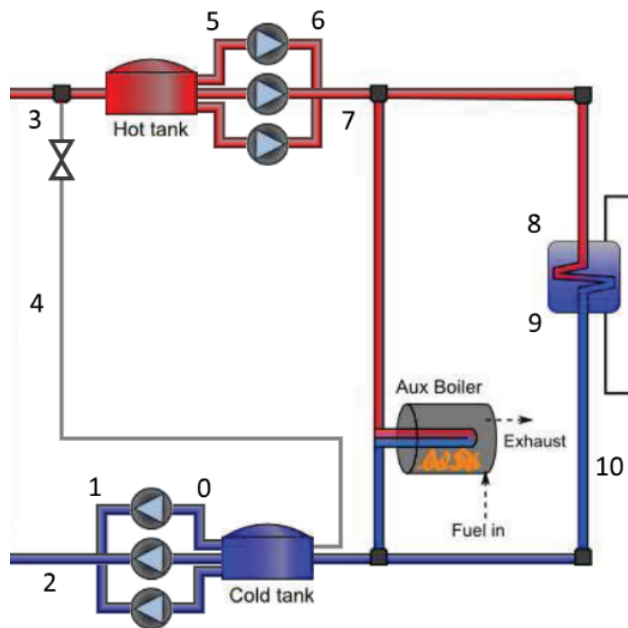
**sgs\_diams [m]**

The custom specified thermal energy storage and power block pipe section diameters. The values are utilized if the parameter `custom_sgs_pipe_sizes` is set to true. The number of diameter values needs to match the number of pipe sections.

**sgs\_lengths [m]**

The custom specified thermal energy storage and power block pipe section lengths. The values are utilized if the parameter `custom_sgs_pipe_sizes` is set to true. The number of length values needs to match the number of pipe sections. Lengths at indices 0, 1, 5 and 6 are the summed lengths of the multiple individual pump sections. The default values are { 0, 90, 100, 120, 0, 0, 0, 0, 80, 120, 80 }, in meters.

Number	From	To
0	Cold thermal storage tank	Individual solar field (SF) pump inlet
1	Individual SF pump discharge	SF pump discharge header
2	SF pump discharge header	SF runners
3	SF runners	Hot thermal storage tank
4	SF runners	Cold thermal storage tank
5	Steam generator system (SGS) pump suction header	Individual SGS pump inlet
6	Individual SGS pump discharge	SGS pump discharge header
7	SGS pump discharge header	Steam generator supply header
8	Steam generator supply header	Inter-steam generator piping
9	Inter-steam generator piping	Steam generator outlet header
10	Steam generator outlet header	Cold thermal storage tank

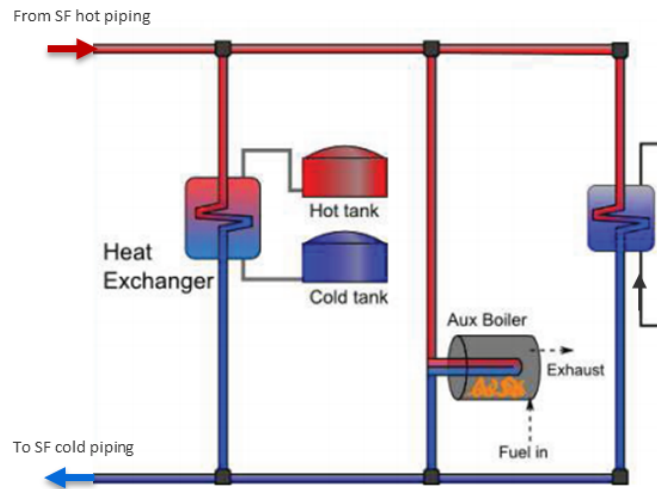
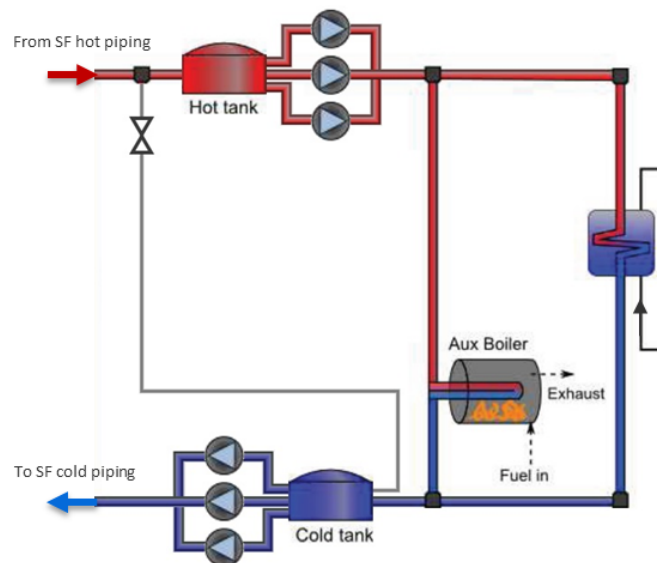


**sgs\_wallthickness [m]**

The custom specified thermal energy storage and power block pipe wall thicknesses. The values are utilized if the parameter `custom_sgs_pipe_sizes` is set to true. The number of wall thickness values needs to match the number of pipe sections.

**tanks\_in\_parallel [-]**

Whether the thermal energy storage tank are in parallel with the field or in series with the field. Tanks in series with the field are specific to direct storage systems as in this configuration the field heat transfer fluid passes through the tanks before entering and after leaving the power block. The default value is false.

**Default (parallel) storage tank configuration**

### New series storage tank option

#### T\_tank\_hot\_inlet\_min [°C]

The minimum field heat transfer fluid temperature that may enter the hot storage tank. If the storage tanks are in series with the field and the temperature is below this value, the bypass valve will open and the field will recirculate. The default value is 400 °C.

#### V\_tes\_des [m/s]

The design velocity for sizing the diameters of the thermal energy storage and power block piping. The default value is 1.85 m/s.

## 18.6 Empirical Trough Model

The empirical trough model models the same type of parabolic trough system as the physical trough model, but uses a set of curve-fit equations derived from regression analysis of data measured from the SEGS projects in the southwestern United States, so you are limited to modeling systems composed of components for which there is measured data. The model is based on Excelergy, originally developed for internal use at the National Renewable Energy Laboratory.

A parabolic trough system is a type of concentrating solar power (CSP) system that collects direct normal solar radiation and converts it to thermal energy that runs a power block to generate electricity. The components of a parabolic trough system are the solar field, power block, and in some cases, thermal energy storage and fossil backup systems. The solar field collects heat from the sun and consists of parabolic, trough-shaped solar collectors that focus direct normal solar radiation onto tubular receivers. Each collector assembly consists of mirrors and a structure that supports the mirrors and receivers, allows it to track the sun on one axis, and can withstand wind-induced forces. Each receiver consists of a metal tube with a solar radiation absorbing surface in a vacuum inside a coated glass tube. A heat transfer fluid (HTF) transports heat from the solar field to the power block (also called power cycle) and other components of the system. The power block is based on conventional power cycle technology, using a turbine to convert thermal energy from the solar field to electric energy. The optional fossil-fuel backup system delivers supplemental heat to the HTF during times when there is insufficient solar energy to drive the power block at its rated capacity.

The empirical parabolic trough model uses a set of equations based on empirical analysis of data collected from installed systems (the SEGS projects in the southwestern United States) to represent the performance of parabolic trough components. The model is based on Excelergy, a model initially developed for internal use at the National Renewable Energy Laboratory. For information about the physical parabolic trough model, see [Parabolic Trough Physical](#).

For a more detailed description of the empirical trough model, see the draft empirical trough reference manual on the [SAM website](#).

**Note.** Many of the input variables in the parabolic trough model are interrelated and should be changed together. For example, the storage capacity, which is expressed in hours of thermal storage, should not be changed without changing the tank heat loss value, which depends on the size of the storage system. Some of these relationships are described in this documentation, but not all.



## 18.6.1 Solar Field

To view the Solar Field page, click **Solar Field** on the main window's navigation menu. Note that for the empirical trough input pages to be available, the technology option in the [Technology and Market](#) window must be Concentrating Solar Power - Empirical Trough System.

The Solar Field page displays variables and options that describe the size and properties of the solar field, properties of the heat transfer fluid, reference design specifications of the solar field, and collector orientation.

### Field Layout

#### Options 1 and 2

For Option 1, (solar multiple mode), you specify a value for **Solar Multiple**, and SAM calculates the solar field area and displays it under **Calculated Values** as **Aperture Reflective Area**. In this mode, SAM ignores the solar field area value under **Field Layout**.

For Option 2 (solar field area mode), you specify a value for **Solar Field Area**, and SAM calculates the solar multiple and displays it under **Calculated Values**. In this mode, SAM ignores the Solar Multiple value under **Field Layout**.

See [Solar Multiple](#) for details.

#### Distance Between SCAs in Row (m)

The end-to-end distance in meters between SCAs (solar collection elements, or collectors) in a single row, assuming that SCAs are laid out uniformly in all rows of the solar field. SAM uses this value to calculate the end loss. This value is not part of the SCA library on the [SCA / HCE page](#), and should be verified manually to ensure that it is appropriate for the SCA type that appears on the SCA / HCE page.

#### Row spacing, center-to-center (m)

The centerline-to-centerline distance in meters between rows of SCAs, assuming that rows are laid out uniformly throughout the solar field. SAM uses this value to calculate the row-to-row shadowing loss factor. This value is not part of the SCA library, and should be verified manually to ensure that it is appropriate for the SCA type that appears on the [SCA / HCE page](#).

#### Number of SCAs per Row

The number of SCAs in each row, assuming that each row in the solar field has the same number of SCAs. SAM uses this value in the SCA end loss calculation.

#### Deploy Angle (degrees)

The SCA angle during the hour of deployment. A deploy angle of zero for a northern latitude is vertical facing due east. SAM uses this value along with sun angle values to determine whether the current hour of simulation is the hour of deployment, which is the hour before the first hour of operation in the morning. SAM assumes that this angle applies to all SCAs in the solar field.

#### Stow Angle (degrees)

The SCA angle during the hour of stow. A stow angle of zero for a northern latitude is vertical facing east, and 180 degrees is vertical facing west. SAM uses this value along with the sun angle values to determine whether the current hour of simulation is the hour of stow, which is the hour after the final hour of operation in the evening.

## Heat Transfer Fluid

### Solar Field HTF Type

The solar field heat transfer fluid (HTF) absorbs heat as it circulates through the heat collection elements in the solar field and transports the heat to the power block where it is used to run a turbine. Several types of heat transfer fluid are used for trough systems, including hydrocarbon (mineral) oils, synthetic oils, silicone oils and nitrate salts.

When you choose a heat transfer fluid, SAM populates the minimum HTF temperature variable with that oil's minimum operating temperature value. SAM will not allow the system to operate at a temperature below the minimum HTF temperature. Electric heaters in the system maintain the fluid temperature. SAM accounts for the electric power requirement for heating on the [Parasitics page](#).

The remaining heat transfer fluid parameters describe characteristics of the solar field that affect the performance of the heat transfer fluid. The two area-related parameters refer to square meters of solar field area.

#### Notes.

Solar field outlet temperature and solar field area data for U.S. parabolic trough power plants are available on the Troughnet website at [http://www.nrel.gov/csp/troughnet/power\\_plant\\_data.html](http://www.nrel.gov/csp/troughnet/power_plant_data.html).

During the simulation, SAM counts the number of instances that the HTF temperature falls outside of the operating temperature limits in the table below. If the number of instances exceeds 50, it displays a simulation [notice](#) with the HTF temperature and time step number for the 50th instance.

If you define a custom fluid, SAM disables the minimum and maximum operating temperature variables and displays zero because it does not have information about the operating limits for the fluid you defined. You can check the time series temperature data in the results to ensure that they do not exceed the limits for your custom fluid.

**Heat transfer fluids on the Field HTF Fluid list.**

Name	Type	Min Optimal Operating Temp °C	Max Optimal Operating Temp* °C	Freeze Point °C	Comments
Hitec Solar Salt	Nitrate Salt	238	593	238	
Hitec	Nitrate Salt	142	538	142	
Hitec XL	Nitrate Salt	120	500	120	
Caloria HT 43	Mineral Hydrocarbon	-12	315	-12 (pour point)	used in first Luz trough plant, SEGS I
Therminol VP-1	Mixture of Biphenyl and Diphenyl Oxide	12	400	12 (crystallization point)	Standard for current generation oil HTF systems
Therminol 59	Synthetic HTF	-45	315	-68 (pour point)	
Therminol 66	?	0	345	-25 (pour point)	
Dowtherm Q	Synthetic Oil	-35	330	n/a	
Dowtherm RP	Synthetic Oil	n/a	330	n/a	

\*The maximum optimal operating temperature is the value reported as "maximum bulk temperature" on the product data sheets.

**Data Sources for HTF Properties**

Hitec fluids: Raade J, Padowitz D, Vaughn J. [Low Melting Point Molten Salt Heat Transfer Fluid with Reduced Cost](#). Halotechnics. Presented at SolarPaces 2011 in Granada, Spain.

Caloria HT 43: [Product comparison tool](#) on Duratherm website.

Therminol Fluids: Solutia [Technical Bulletins](#) 7239115C, 7239271A, 7239146D.

Dowtherm Fluids: Dow [Data Sheet](#) for Q, no data sheet available for RP (high temp is from website): <http://www.dow.com/heattrans/products/synthetic/dowtherm.htm>.

**Solar Field Inlet Temp (°C)**

Design temperature of the solar field inlet in degrees Celsius used to calculate design solar field average temperature, and design HTF enthalpy at the solar field inlet. SAM also limits the solar field inlet temperature to this value during operation and solar field warm up, and uses this value to calculate the actual inlet temperature when the solar field energy is insufficient for warm-up.

**Solar Field Outlet Temp (°C)**

Design temperature of the solar field outlet in degrees Celsius, used to calculate design solar field average temperature. It is also used to calculate the design HTF enthalpy at the solar field outlet, which SAM uses to determine whether solar field is operating or warming up. SAM also uses this value to calculate the actual inlet temperature when the solar field energy is insufficient for warm-up.

**Solar Field Initial Temp (°C)**

Initial solar field inlet temperature. The solar field inlet temperature is set to this value for hour one of the simulation.

**Piping Heat Losses @ Design Temp (W/m<sup>2</sup>)**

Solar field piping heat loss in Watts per square meter of solar field area when the difference between the average solar field temperature and ambient temperature is 316.5°C. Used in solar field heat loss calculation.

**Piping Heat Loss Coeff (1-3)**

These three values are used with the solar field piping heat loss at design temperature to calculate solar field piping heat loss.

**Solar Field Piping Heat Losses (W/m<sup>2</sup>)**

Design solar field piping heat losses. This value is used only in the solar field size equations. This design value different from the hourly solar field pipe heat losses calculated during simulation.

$$\text{Solar Field Piping Heat Losses} = ( \text{PHLTC3} \times T^3 + \text{PHLTC2} \times T^2 + \text{PHLTC1} \times T ) \times \text{Solar Field Piping Heat Losses @ Design T}$$

$$T = \text{Average Solar Field Temperature} - \text{Ambient Temp}$$

$$\text{Average Solar Field Temperature} = ( \text{Solar Field Inlet Temp} + \text{Solar Field Outlet Temp} ) \div 2$$

Where PHLTC1-3 are the Piping Heat Loss Coefficients you specify, and the temperature value are design point values that you specify as inputs. During the simulation, SAM calculates the actual piping heat losses using simulated field temperatures and the ambient temperature from the weather file you specify on the [Location and Resource](#) page.

**Minimum HTF Temp (°C)**

Minimum heat transfer fluid temperature in degrees Celsius. SAM automatically populates the value based on the properties of the solar field HTF type, i.e., changing the HTF type changes the minimum HTF temperature. The value determines when freeze protection energy is required, is used to calculate HTF enthalpies for the freeze protection energy calculation, and is the lower limit of the average solar field temperature. SAM assumes that heat protection energy is supplied by electric heat trace equipment.

**HTF Gallons Per Area (gal/m<sup>2</sup>)**

Volume at 25°C of HTF per square meter of solar field area, used to calculate the total mass of HTF in the solar field, which is used to calculate solar field temperatures and energies during hourly simulations. The volume includes fluid in the entire system including the power block and storage system if applicable. Example values are: SEGS VI: 115,000 gal VP-1 for a 188,000 m<sup>2</sup> solar field is 0.612 gal/m<sup>2</sup>, SEGS VIII 340,500 gal VP-1 and 464,340 m<sup>2</sup> solar field is 0.733 ga/m<sup>2</sup>.

**Land Area**

The land area inputs determine the total land area in acres that you can use to estimate land-related costs in \$/acres on the [System Costs](#) page. The land area inputs are inputs to the financial model, not the performance model, so they do not affect the performance model energy calculations.

**Solar field area, acres**

The actual aperture area converted from square meters to acres:

$$\text{Solar Field Area (acres)} = \text{Actual Aperture (m}^2\text{)} \times \text{Row Spacing (m)} / \text{Maximum SCA Width (m)} \times$$

0.0002471 (acres/m<sup>2</sup>)

The maximum SCA width is the aperture width of SCA with the widest aperture in the field, as specified in the loop configuration and on the [Collectors \(SCA\)](#) page.

#### Non-solar field land area multiplier

Land area required for the system excluding the solar field land area, expressed as a fraction of the solar field aperture area. A value of one would result in a total land area equal to the total aperture area.

#### Total land area, acres

Land area required for the entire system including the solar field land area

$$\text{Total Land Area (acres)} = \text{Solar Field Area (acres)} \times (1 + \text{Non-Solar Field Land Area Multiplier})$$

The land area appears on the System Costs page, where you can specify land costs in dollars per acre.

### Solar Multiple (Design Point)

**Note.** The ambient temperature, direct normal radiation, and wind velocity reference variables differ from the hourly weather data that SAM uses for system output calculations. SAM uses the reference ambient condition variables to size the solar field. Hourly data from the weather file shown on the [Location and Resource](#) page determine the solar resource at the site.

### Calculated Values

The two calculated values variables depend on whether you choose Option 1 or Option 2 to specify the solar field size. When you choose Option 1, the solar multiple calculated value is equal to the value you specify under **Field Layout** and SAM calculates the aperture reflective area. When you choose Option 2, the aperture reflective area is equal to the Solar Field Area value you specify, and SAM calculates the solar multiple.

#### Solar Multiple

The solar field area expressed as a multiple of the exact reflective area for a solar multiple of 1 (see "Reference Conditions (SM=1)" below). SAM uses the calculated solar multiple value to calculate the design solar field thermal energy and the maximum thermal energy storage charge rate.

$$\text{Solar Multiple} = \text{Aperture Reflective Area} \div \text{Exact Aperture Reflective Area at SM=1}$$

#### Aperture Reflective Area (m<sup>2</sup>)

The total reflective area of collectors in solar field expressed in square meters. SAM uses this value in the delivered thermal energy calculations. This area is the total collection aperture area, which is less than the mirror area. The solar field area does not include space between collectors or the land required by the power block.

$$\text{Aperture Reflective Area} = \text{Solar Multiple} \times \text{Exact Aperture Reflective Area at SM=1}$$

### Solar Multiple Reference Conditions

#### Ambient Temp (°C)

Reference ambient temperature in degrees Celsius. Used to calculate the design solar field pipe heat losses.

**Direct Normal Radiation (W/m<sup>2</sup>)**

Reference direct normal radiation in Watts per square meter. Used to calculate the solar field area that would be required at this insolation level to generate enough thermal energy to drive the power block at the design turbine thermal input level. SAM also uses this value to calculate the design HCE heat losses displayed on the [SCA / HCE page](#). The appropriate value depends on the system location. For example, 950 W/m<sup>2</sup> is an appropriate value for the Mohave Desert and typical locations under consideration for development in the U.S., and 800 W/m<sup>2</sup> is appropriate for southern Spain.

**Note.** Direct Normal Radiation does not represent weather conditions at the site, but is the reference radiation value used to calculate the solar field area when the solar multiple is one. The radiation values used during simulation are from the weather file specified on the [Location and Resource](#) page.

**Wind Velocity (m/s)**

Reference wind velocity in meters per second. SAM uses this value to calculate the design HCE heat losses displayed on the [SCA / HCE page](#).

**Reference Condition (SM=1)****Exact Aperture Reflective Area (m<sup>2</sup>)**

The solar field area required to deliver sufficient solar energy to drive the power block at the design turbine gross output level under reference weather conditions. It is equivalent to a solar multiple of one, and used to calculate the solar field area when the Layout mode is Solar Multiple.

$$\begin{aligned} \text{Exact Aperture Reflective Area} = & \text{Design Turbine Thermal Input} \\ & \div ( \text{Direct Normal Radiation} \times \text{Optical Efficiency} \\ & \quad - \text{HCE Thermal Losses} \\ & \quad - \text{Solar Field Piping Heat Losses} ) \end{aligned}$$

**Exact Num. SCAs**

The exact aperture reflective area divided by the SCA aperture reflective area. SAM uses the nearest integer greater than or equal to this value in the solar field size equations to calculate value of the Aperture Reflective Area variable described above. The exact number of SCAs represents the number of SCAs in a solar field for a solar multiple of one.

$$\text{Exact Num SCAs} = \text{Exact Aperture Reflective Area} \div \text{Aperture Area per SCA}$$

**Values from Other Pages****Aperture Area per SCA (m<sup>2</sup>)**

SCA aperture reflective area variable from the [SCA / HCE page](#). SAM uses this value in the solar field size equations to calculate the value of the Aperture Reflective Area variable described above.

**HCE Thermal Losses (W/m<sup>2</sup>)**

Design HCE thermal losses based on the heat loss parameters from the [SCA / HCE page](#). SAM uses this value only in the solar field size equations. This design value is different from the hourly HCE thermal losses calculated during simulation.

**Optical Efficiency**

Weighted optical efficiency variable from the [SCA / HCE page](#). SAM uses this design value only in the solar field size equations. This design value is different from SCA efficiency factor calculated during the simulation.

**Design Turbine Thermal Input (MWt)**

Design turbine thermal input variable from the [Power Block page](#). Used to calculate the exact aperture reflective area described above.

**Orientation****Collector Tilt (degrees)**

The collector angle from horizontal, where zero degrees is horizontal. A positive value tilts up the end of the array closest to the equator (the array's south end in the northern hemisphere), a negative value tilts down the southern end. Used to calculate the solar incidence angle and SCA tracking angle. SAM assumes that the SCAs are fixed at the tilt angle.

**Collector Azimuth (degrees)**

The azimuth angle of the collector, where zero degrees is pointing toward the equator, equivalent to a north-south axis. Used to calculate the solar incidence angle and the SCA tracking angle. SAM calculates the SCAs' tracking angle for each hour, assuming that the SCAs are oriented 90 degrees east of the azimuth angle in the morning and track the daily movement of the sun from east to west.

**18.6.2 Collectors (SCAs)**

A solar collector assembly (SCA) is an individually tracking component of the solar field that includes mirrors, a supporting structure, and heat collection elements or receivers.

For a more detailed description of the model, please download the CSP trough reference manual from the [SAM website](#).

**Solar Collector Assembly (SCA)**

The solar collector assembly (SCA) input variables describe the dimensions and optical characteristics of the SCA or collector.

**Current SCA inputs**

The name of the collector in the SCA library

**SCA Length (m)**

The total length of a single SCA. Used in SCA end loss calculation.

**SCA Aperture (m)**

The structural width of a single SCA, including reflective area and gaps. Used in the row-to-row shadowing loss factor and HCE thermal loss calculations.

**SCA Aperture Reflective Area (m<sup>2</sup>)**

The reflective area of a single SCA, not including gaps. Used in the solar field size calculations.

**Average Focal Length (m)**

Average trough focal length. Used in end gain and end loss factor calculations.

**Incident Angle Modifier Coef F0, F1, F2**

Incident angle modifier coefficients. Used to calculate the incident angle modifier factor, which is used to calculate the HCE absorbed energy and the solar field optical efficiency.

**Tracking Error and Twist**

Accounts for errors in the SCA's ability to track the sun. Sources of error may include poor alignment of sun sensor, tracking algorithm error, errors caused by the tracker drive update rate, and twisting of the SCA end at the sun sensor mounting location relative to the tracking unit end. A typical value is 0.985. Used to calculate SCA field error factor.

**Geometric Accuracy**

Accounts for SCA optical errors caused by misaligned mirrors, mirror contour distortion caused by the support structure, mirror shape errors compared to an ideal parabola, and misaligned or distorted HCE. A typical range of values is between 0.97 and 0.98. Used to calculate SCA field error factor.

**Mirror Reflectance**

The mirror reflectance input is the solar weighted specular reflectance. The solar-weighted specular reflectance is the fraction of incident solar radiation reflected into a given solid angle about the specular reflection direction. The appropriate choice for the solid angle is that subtended by the receiver as viewed from the point on the mirror surface from which the ray is being reflected. For parabolic troughs, typical values for solar mirrors are 0.923 (4-mm glass), 0.945 (1-mm or laminated glass), 0.906 (silvered polymer), 0.836 (enhanced anodized aluminum), and 0.957 (silvered front surface).

**Mirror Cleanliness Factor (avg)**

Accounts for dirt and dust on the mirrors that reduce their effective reflectivity. Typically, mirrors are continuously cleaned, but a single mirror may be cleaned once each one or two weeks. The expected overall effect on the total solar field would be an average loss of between one and two percent. A typical value would be 0.985. Used to calculate SCA field error factor.

**Dust on Envelope (avg)**

Accounts for dust on the HCE envelope that affects light transmission. A typical value would be 0.99. Used to calculate HCE heat loss.

**Concentrator Factor**

A additional error factor to make it possible to adjust the SCE performance without modifying the other error factors. Useful for modeling an improved or degraded SCE. The default value is 1. Used to calculate SCA field error factor.

**Solar Field Availability**

Accounts for solar field down time for maintenance and repairs. Used to calculate absorbed energy.

 About the SCA Parameters



The default SCA library includes a set of parameters for four types of SCAs described in the table below. These SCA types are either installed in currently operating systems, or were used in past system designs. See [Working with Libraries](#) for information about managing libraries.

**Table 4. Default collector types.**

Name	Description	Location
Euro Trough ET150	Torque box, galvanized steel	SEGS V, Kramer Junction, California
Luz LS-2	Torque-tube, galvanized steel	SEGS I - VII, Kramer Junction, California
Luz LS-3	Bridge truss, galvanized steel	SEGS VII - IX, Kramer Junction, California
Solargenix SGX-1	Organic hubbing structure, extruded aluminum	Nevada Solar One, Boulder City, Nevada

The values of input variables on the SCA / HCE page are stored in libraries. See [Working with Libraries](#) for information about managing libraries.

### 18.6.3 Receivers (HCEs)

A heat collection element (HCE) is a metal pipe contained in a vacuum within glass tube that runs through the focal line of the trough-shaped parabolic collector. Seals and bellows ensure that a vacuum is maintained in each tube. Anti-reflective coatings on the glass tube maximize the amount of solar radiation that enters the tube. Solar-selective radiation absorbing coatings on the metal tube maximize the transfer of energy from the solar radiation to the pipe.

The Receivers (HCEs) variables describe the properties of up to four HCE types that can make up the solar field. This makes it possible to model a solar field with HCEs in different states. Each set of properties applies to one of the HCE types. The Fraction of Field variable determines what portion of the solar field is made up of a given HCE type.

#### Current HCE inputs

The name of the receiver and its condition. Vacuum refers to an HCE in good condition, lost vacuum, broken glass, and hydrogen refer to different problem conditions. You can define up to four HCE (receiver) conditions.

#### Fraction of Field

Fraction of solar field using this HCE type and condition. Used to calculate HCE field error factor and HCE heat loss.

#### Bellows Shadowing

The portion of the HCE tube that does not absorb solar thermal radiation. Used to calculate HCE field error factor.

**Envelope Transmissivity**

Used to calculate HCE field error factor.

**Absorber Absorption**

Accounts for inefficiencies in the HCE black coating. Used to calculate HCE field error factor.

**Unaccounted**

Allows for adjustment of the HCE performance to explore effect of changes in performance of the HCE without changing the values of other correction factors. A typical value is 1. Used to calculate HCE field error factor.

**Optical Efficiency (HCE)**

The design optical efficiency of each of the four receiver type and condition options. SAM uses the values to calculate the design weighted optical efficiency.

$$\text{Optical Efficiency} = \text{SCA Field Error} \times \text{Dust on Envelope} \times \text{Bellows Shadowing} \times \text{Envelope Transmissivity} \times \text{Absorber Absorption} \times \text{Unaccounted}$$

$$\text{SCA Field Error} = \text{Tracking Error and Twist} \times \text{Geometric Accuracy} \times \text{Mirror Reflectivity} \times \text{Mirror Cleanliness Factor} \times \text{Concentrator Factor}$$

**Optical Efficiency (Weighted)**

The design weighted optical efficiency, representing the average optical efficiency of all receivers in the field. SAM uses the value to calculate the solar field area. Note that SAM also calculates a separate HCE optical efficiency value for each hour during simulation that counts for the loss factors on the SCA / HCE page that also accounts for the incident angle modifier factor, which depends on the time of day and collector orientation.

$$\text{Optical Efficiency Weighted} = \text{Optical Efficiency 1} \times \text{Percent of Solar Field 1} + \text{Optical Efficiency 2} \times \text{Percent of Solar Field 2} + \text{Optical Efficiency 3} \times \text{Percent of Solar Field 3} + \text{Optical Efficiency 4} \times \text{Percent of Solar Field 4}$$

**Heat Loss Coefficient A0...A6**

Used to calculate the HCE heat loss. The default values are based on NREL modeling and test results. (See Forristall R, 2003. Heat Transfer Analysis and Modeling of a Parabolic Trough Solar Receiver Implemented in Engineering Equation Solver. National Renewable Energy Laboratory NREL/TP-550-34169. <http://www.nrel.gov/csp/troughnet/pdfs/34169.pdf>, and Burkholder F et al, 2009, Heat Loss Testing of Schott's 2008 PTR70 Parabolic Trough Receiver. National Renewable Energy Laboratory NREL/TP-550-45633. <http://www.nrel.gov/csp/troughnet/pdfs/45633.pdf>)

**Heat Loss Factor**

The design heat loss factor that applies to the active HCE type and condition. Used to calculate design HCE heat loss that is part of the solar field area equation. The heat loss factor scales the heat loss equation and can be used to fine tune the results when measured heat loss data are available. The default value of 1.0 is valid for the current version of SAM using the default heat loss coefficients.

**Min windspeed (m/s)**

Used to calculate the HCE heat loss for hours when the wind speed from the weather file is lower than the minimum wind speed.

The following heat loss values are provided for reference. SAM calculates the HCE heat loss for each hour during simulation based on the loss factor coefficients on the SCA / HCE page and other values from the weather data.

**HCE Heat Losses (W/m)**

$$Q_{HCEHLD,n} = (Q_{HCEHLD1,n} + Q_{HCEHLD2,n} + Q_{HCEHLD3,n} + Q_{HCEHLD4,n}) \cdot F_{HeatLoss,n}$$

$$Q_{HCEHLD1,n} = F_{HLA0} + F_{HLA5} \cdot \sqrt{v_{WindRef}}$$

$$Q_{HCEHLD2,n} = (F_{HLA1} + F_{HLA6} \cdot \sqrt{v_{WindRef}}) \cdot \frac{T_{SFOutD} + T_{SFInD} - T_{AmbientRef}}{2}$$

$$Q_{HCEHLD3,n} = (F_{HLA2} + F_{HLA4} \cdot Q_{DNIRef}) \cdot \frac{T_{SFOutD}^2 + T_{SFOutD} \cdot T_{SFInD} + T_{SFInD}^2}{3}$$

$$Q_{HCEHLD4,n} = F_{HLA3} \cdot \frac{(T_{SFOutD}^2 + T_{SFInD}^2) \cdot (T_{SFOutD} + T_{SFInD})}{4}$$

Where,

$Q_{HCEHLD,n}$ (W/m)	HCE heat losses for HCE type $n$ expressed in thermal Watts per meter
$F_{HeatLoss,n}$	Heat Loss Factor for HCE type $n$
$F_{A0} \dots F_{A6}$	A0 Heat Loss Coefficient through A6 Heat Loss Coefficient
$T_{SFIn}$ (°C)	Solar Field Inlet Temperature from the <a href="#">Solar Field page</a>
$T_{SFout}$ (°C)	Solar Field Outlet Temperature from the Solar Field page
$T_{Amb}$ (°C)	Reference ambient temperature from the Solar Field page
$Q_{DNIRef}$	Reference direct normal radiation from the Solar Field page
$v_{Wind}$ (m/s)	Reference wind velocity from the Solar Field page

**Thermal Losses (Weighted W/m)**

*Thermal Losses Weighted W/m = HCE Heat Losses 1 × Percent of Solar Field 1 + HCE Heat Losses 2 × Percent of Solar Field 2 + HCE Heat Losses 3 × Percent of Solar Field 3 + HCE Heat Losses 4 × Percent of Solar Field 4*

**Thermal Losses (Weighted W/m<sup>2</sup>)**

Thermal Losses Weighted W/m<sup>2</sup> = Thermal Losses Weighted W/m ÷ SCA Aperture

## ▼ About the HCE Parameters

The HCE library includes four HCE types, and for each HCE type, five HCE conditions. See [Working with Libraries](#) for information about managing libraries.

For each HCE type and condition, you can assign a Percent of Field value. For example, in the figure below, the receiver type is Schott PTR70, and 98.5% percent of the HCEs are in normal condition, 1.0% have lost vacuum, 0.5% have glass damage, and 0% have allowed hydrogen to enter the tube.

When you select a name from the Receiver Type and Condition list, SAM populates the optical and heat loss parameters using values stored in the library. When you change one or more of these values, SAM creates a copy of the parameter set and adds it to the library under the name "CUSTOM CUSTOM."

The four HCE types are described in the table below.

**Table 5. Default HCE types.**

HCE Type	Description
Luz Cermet	Original HCE design. Low reliability of seals.
Schott PTR70 Vacuum	Newer design with improved reliability. Two versions are available.
Solel UVAC2	Newer design with improved reliability.
Solel UVAC3	The newest HCE available as of May 2008.

The performance of the HCE is highly dependent on the quality of the vacuum in the glass tube. SAM models the HCE under the five conditions described in the following table.

**Table 6. HCE conditions.**

HCE Condition	Description
Broken glass	Glass tube is damaged, increasing heat transfer between tube and atmosphere.
Fluorescent	Selective coating on metal tube is compromised, reducing absorption of solar radiation
Hydrogen	Hydrogen from hydrocarbon-based heat transfer fluid (e.g., mineral oil) has permeated through metal tube into the vacuum, increasing heat transfer between metal tube and glass.
Lost vacuum	Glass-to-metal seal is compromised
Vacuum	HCE is not damaged and is operating as designed.

## 18.6.4 Power Block

To view the Power Block page, click **Power Block** on the main window's navigation menu. Note that for the empirical trough input pages to be available, the technology option in the [Technology and Market](#) window must be Concentrating Solar Power - Empirical Trough System.

The Power Block parameters describe the equipment in the system that converts thermal energy from the solar field or thermal energy storage system into electricity. The power block is based on a steam turbine that runs on a conventional Rankine power cycle and may or may not include fossil fuel backup. Power block components include a turbine, heat exchangers to transfer heat from the solar field or thermal energy storage system to the turbine, and a cooling system to dissipate waste heat. SAM considers the thermal energy storage system to be a separate component, which is described on the [Thermal Storage page](#).

The input variables on the Power Block page are divided into two groups. The turbine ratings group determines the capacity of the power block, and the power cycle group defines the performance parameters of the reference turbine.

For a more detailed description of the model, please download the CSP trough reference manual from the [SAM website](#).

## ▼ Input Variable Reference

### Plant Characteristics

#### Design Gross Output (MWe)

The power cycle's design output, not accounting for parasitic losses. SAM uses this value to size system components, such as the solar field area when you use the solar multiple to specify the solar field size.

#### Estimated Gross to Net Conversion Factor

An estimate of the ratio of the electric energy delivered to the grid to the power cycle's gross output. SAM uses the factor to calculate the system's nameplate capacity for capacity-related calculations, including the estimated total cost per net capacity value on the [System Costs page](#), capacity-based incentives on the [Incentives](#) page, and the capacity factor reported in the [results](#).

#### Estimated Net Output at Design (MWe)

The power cycle's nominal capacity, calculated as the product of the design gross output and estimated gross to net conversion factor. SAM uses this value to calculate the system's rated capacity for capacity-related calculations, including the estimated total cost per net capacity value on the [System Costs page](#), capacity-based incentives on the [Incentives](#) page, and the capacity factor reported in the [results](#).

### System Availability

System availability losses are reductions in the system's output due to operational requirements such as maintenance down time or other situations that prevent the system from operating as designed.

**Note.** To model curtailment, or forced outages or reduction in power output required by the grid operator, use the inputs on the [Grid Limits](#) page.

To edit the system availability losses, click **Edit losses**.

The [Edit Losses](#) window allows you to define loss factors as follows:

- Constant loss is a single loss factor that applies to the system's entire output. You can use this to model an availability factor.
- Hourly losses apply to specific hours of the year.

SAM reduces the system's output in each hour by the loss percentage that you specify for that hour. For a given hour, a loss of zero would result in no adjustment. A loss of 5% would reduce the output by 5%, and a loss of -5% would increase the output value by 5%. For subhourly simulations, SAM applies the loss factor for a given hour to each time step in that hour

### Power Cycle

The variables in the power cycle group describe a reference steam turbine. SAM uses the reference turbine specifications to calculate the turbine output, and then scales the actual output based on the turbine rating variables. Each set of reference turbine specifications is stored in the reference turbine library.

**Current Power Block**

Name of the reference turbine. Selecting a reference system determines the values of the other power cycle variables.

**Design Cycle Thermal Input (MWt)**

The thermal energy required as input to the power block to generate the design turbine gross (electric) output. SAM uses the design turbine thermal input to calculate several power block capacity-related values, including the solar field size, power block design point gross output, and parasitic losses.

$$\text{Design Cycle Thermal Input} = \text{Design Turbine Gross Output} \div \text{Rated Cycle Conversion Efficiency}$$

**Rated Cycle Conversion Efficiency**

Total thermal to electric efficiency of the reference turbine. Used to calculate the design turbine thermal input.

**Max Turbine Over Design Operation**

The turbine's maximum output expressed as a fraction of the design turbine thermal input. Used by the dispatch module to set the power block thermal input limits.

**Min Turbine Operation**

The turbine's minimum load expressed as a fraction of the design turbine thermal input. Used by the dispatch module to set the power block thermal input limits.

**Frac of Thermal Power for Startup**

Fraction of the design turbine thermal input required to bring the system to operating temperature after a period of non-operation. Used by the dispatch module to calculate the required start-up energy.

**Boiler LHV Efficiency**

The back-up boiler's lower heating value efficiency. Used by the power block module to calculate the quantity of gas required by the back-up boiler.

**Max Thermal Input (MWt)**

The maximum thermal energy that can be delivered to the power block by the solar field, thermal energy storage system or both.

$$\text{Max Thermal Input} = \text{Design Cycle Thermal Input} \times (F4 \times \text{Max Turbine Over Design Operation}^4 + F3 \times \text{Max Turbine Over Design Operation}^3 + F2 \times \text{Max Turbine Over Design Operation}^2 + F1 \times \text{Max Turbine Over Design Operation} + F0)$$

Where F0-4 are the Cycle Part-load Elec to Therm factors that you specify.

**Min Thermal Input (MWt)**

The minimum thermal energy that can be delivered to the power block by the solar field, thermal energy storage system or both.

$$\text{Min Thermal Input} = \text{Design Cycle Thermal Input} \times (F4 \times \text{Min Turbine Operation}^4 + F3 \times \text{Max Turbine Over Design Operation}^3 + F2 \times \text{Min Turbine Operation}^2 + F1 \times \text{Min Turbine Operation} + F0)$$

Where F0-4 are the Cycle Part-load Elec to Therm factors that you specify.

**Cycle Part-load Therm to Elec**

Factors for the turbine thermal-to-electric efficiency polynomial equation. Used to calculate the design point gross output, which is the portion of the power block's electric output converted from solar energy before losses. See [Power Block Simulation Calculations](#) for details.

### Cycle Part-load Elec to Therm

Factors for turbine's part load electric-to-thermal efficiency polynomial equation. Used to calculate the energy in kilowatt-hours of natural gas equivalent required by the backup boiler. SAM dispatches the backup boiler based on the fossil-fill fraction table in the thermal storage dispatch parameters on the [Thermal Storage page](#).

### Cooling Tower Correction

Cooling tower correction factor. Used to calculate the temperature correction factor that represents cooling tower losses. To model a system with no cooling tower, set F0 to 1, and F1 = F2 = F3 = F4 = 0.

### Temperature Correction Mode

In the dry bulb mode, SAM calculates a temperature correction factor to account for cooling tower losses based on the ambient temperature from the weather data set. In wet bulb mode, SAM calculates the wet bulb temperature from the ambient temperature and relative humidity from the weather data.

## ▼ Power Cycle Library Options

The power cycle library includes six reference turbines. See [Working with Libraries](#) for information about managing libraries.

The reference turbines include five conventional Rankine-cycle steam turbines in a range of sizes, and one organic Rankine-cycle turbine. Conventional Rankine-cycle turbines are similar to those used in coal, nuclear, or natural gas power plants. A heat exchanger transfers energy from the solar field's heat transfer fluid to generate steam that drives the turbine. The organic Rankine-cycle turbine operates on the same principle as the conventional turbine, but uses an organic fluid, typically butane or pentane, to run the turbine instead of water.

**Table 7. Power cycle reference systems.**

Reference System	Approximate Solar Field Size Range m <sup>2</sup>	Approximate Operating Temperature °C	Suggested Modeling Application
APS Omat 1 MWe 300C	10,000	300	Organic Rankine-cycle power block
Nexant 450C HTF	-	450	High-temperature heat transfer fluid (molten salt)
Nexant 500C HTF	-	500	High-temperature heat transfer fluid (molten salt)
SEGS 30 MWe Turbine	180,000 - 230,000	300 - 400	Typical applications
SEGS 80 MWe Turbine	460,000 - 480,000	400	Typical applications
Siemens 400C HTF		400	High-temperature heat transfer fluid

When you choose a turbine from the reference system library, SAM changes the values of the Power Cycle variables. The following table shows the power cycle parameters for the standard reference systems. Note

that you can use any value for the Rated Turbine Net Capacity and Design Turbine Gross Output variables, SAM will use the reference system parameters with the rated and design turbine parameters.



**Table 8. Reference system parameters.**

Parameter Name	SEGS 30	SEGS 80	APS ORC	Nexant 450	Nexant 500	Siemens 400
Estimated Net Output at Design	30	80	1	100	100	50
Design Gross Output	35	89	1.160	110	110	55
Design Cycle Thermal Input	93.3	235.8	5.600	278.0	269.9	147.2
Rated Cycle Conversion Efficiency	0.3749	0.3774	0.2071	0.3957	0.4076	0.3736
Max Turbine Over Design Operation	1.15	1.15	1.15	1.15	1.15	1.15
Min Turbine Operation	0.15	0.15	0.15	0.15	0.15	0.15
Cycle Part-load Therm to Elec F0	-0.0571910	-0.0377260	-0.1593790	-0.0240590	-0.0252994	-0.0298
Cycle Part-load Therm to Elec F1	1.0041000	1.0062000	0.9261810	1.0254800	1.0261900	0.7219
Cycle Part-load Therm to Elec F2	0.1255000	0.0763160	1.1349230	0.0000000	0.0000000	0.7158
Cycle Part-load Therm to Elec F3	-0.0724470	-0.0447750	-1.3605660	0.0000000	0.0000000	-0.5518
Cycle Part-load Therm to Elec F4	0.0000000	0.0000000	0.4588420	0.0000000	0.0000000	0.1430
Cycle Part-load Elec to Therm F0	0.0565200	0.0373700	0.1492050	0.0234837	0.0246620	0.044964
Cycle Part-load Elec to Therm F1	0.9822000	0.9882300	0.8521820	0.9751230	0.9744650	1.182900
Cycle Part-load Elec to Therm F2	-0.0982950	-0.0649910	-0.3247150	0.0000000	0.0000000	-0.563880
Cycle Part-load Elec to Therm F3	0.0595730	0.0393880	0.4486300	0.0000000	0.0000000	0.467190

You can use any of the built-in power cycle options to model most systems expected to run at or near the power block's design point for most operating hours. You can specify your own power cycle if you have a set of part load coefficients from the manufacturer, or if you have calculated coefficients using power plant simulation or equation solving software. The part load equation is a fourth-order or lower polynomial equation that describes the relationship between power cycle efficiency and operating load.

## ▼ Power Block Simulation Calculations

The equations below show how SAM uses the Power Cycle parameters during the simulation to calculate the thermal energy delivered to the power block,  $\dot{Q}_{pb}$ . You can use this information to develop your own set of coefficients instead of coefficients from the power cycle library.

$$\overline{\dot{Q}_{pb}} = \frac{\dot{Q}_{pb}}{\dot{Q}_{design}}$$

This is the non-dimensional thermal energy into the power block. This fractional value is input into the **Cycle Part-load Therm to Elec** polynomial equation that describes non-dimensional net electric output as a function of load:

$$\overline{\dot{W}_{gr}} = F_0 + F_1 \cdot \overline{\dot{Q}_{pb}} + F_2 \cdot \overline{\dot{Q}_{pb}}^2 + F_3 \cdot \overline{\dot{Q}_{pb}}^3 + F_4 \cdot \overline{\dot{Q}_{pb}}^4$$

This non-dimensional gross cycle output is multiplied by the design-point gross cycle output to get the preliminary dimensional gross power output:

$$\dot{W}_{gr} = \overline{\dot{W}_{gr}} \cdot \dot{W}_{gr,design}$$

The gross power output is also adjusted by the ambient temperature using the **Cooling Tower Correction** polynomial. It generally follows the same form as the polynomial for load shown above, except the non-dimensional load term ( $\overline{\dot{Q}_{pb}}$ ) is replaced by the actual wet or dry-bulb temperature in units of °C. The temperature adjustment factor is calculated as follows:

$$X_T = F_{T0} + F_{T1} \cdot T_{amb} + F_{T2} \cdot T_{amb}^2 + F_{T3} \cdot T_{amb}^3 + F_{T4} \cdot T_{amb}^4$$

The gross power cycle output is then multiplied by the temperature correction factor to increase or decrease the total power cycle productivity.

$$\dot{W}_{gr} = \overline{\dot{W}_{gr}} \cdot X_T$$

The **Cycle Part-load Elec to Therm** polynomial equation is used to determine the performance and fuel consumption of the fossil backup system. Note that this relationship is only used when the fossil backup system is running and is not part of the normal solar-to-electric conversion process. The formula for obtaining heat input from a fossil backup using the polynomial coefficients depends on whether the fossil backup in combination with thermal storage and energy from the solar field can meet the design-point thermal input of the power cycle. If the total thermal input including fossil backup meets the thermal load requirement for the power cycle, the fuel usage is calculated at the design-point as follows:

$$\dot{Q}_{gas} = X_{fossil} \cdot \frac{\dot{Q}_{pb,design}}{\dot{W}_{pb,design} \cdot \eta_{LHV}}$$

The fraction of the thermal load that is supplied by fossil energy is indicated as  $X_{fossil}$  in this equation, and the lower-heating-value efficiency of the fossil source is  $\eta_{LHV}$ . In cases where the total thermal input to the

power cycle falls short of the amount required to power the cycle at full load, a polynomial equation with user-defined coefficients is used to calculate the conversion efficiency.

$$\dot{Q}_{gas} = \left[ \dot{Q}_{pb,design} \cdot \left( F_{f0} + F_{f1} \cdot \overline{Q}_{pb} + F_{f2} \cdot \overline{Q}_{pb}^2 + F_{f3} \cdot \overline{Q}_{pb}^3 + F_{f4} \cdot \overline{Q}_{pb}^4 \right) - (\dot{Q}_{sf} + \dot{Q}_{TES}) \right] \cdot \frac{1}{\eta_{LHV}}$$

In this case, the total non-dimensional energy to the power cycle  $\overline{Q}_{pb}$  is equal to the sum of the contributions from thermal storage, the solar field, and the fossil backup. Consequently, the non-fossil contributions are subtracted after the polynomial result has been applied. The total fuel consumption is calculated by converting from thermal energy to fuel usage with the lower-heating-value efficiency.

## 18.6.5 Thermal Storage

To view the Thermal Storage page, click **Thermal Storage** on the main window's navigation menu. Note that for the empirical trough input pages to be available, the technology option in the [Technology and Market](#) window must be Concentrating Solar Power - Empirical Trough System.

A thermal energy storage system (TES) stores heat from the solar field in a liquid medium. Heat from the storage system can drive the power block turbine during periods of low or no sunlight. A TES is beneficial in many places where the peak demand for power occurs after the sun has set. Adding TES to a parabolic trough system allows the collection of solar energy to be separated from the operation of the power block. For example, a system might be able to collect energy in the morning and use it to generate electricity late into the evening.

In direct systems, the heat transfer fluid itself serves as the storage medium. In indirect systems, a separate fluid is the storage medium, and heat is transferred from the HTF to the storage medium through heat exchangers. The TES system two tanks, pumps to circulate the liquids, and depending on the design, heat exchangers. The two-tank system consists of a hot tank to store heat from the solar field, and a cold tank to store the cooled storage medium after the power block has extracted its energy.

The user inputs on the Thermal Storage page are divided into two groups. The thermal energy storage (TES) group defines the thermal energy storage capacity and type along with some efficiency parameters. The thermal storage dispatch controls group variables determine the operation of the storage and fossil back up systems.

For a more detailed description of the model, please download the CSP trough reference manual from the [SAM website](#).

## Input Variable Reference

### Thermal Energy Storage (TES)

#### Equiv Full Load Hours of TES hours (hours)

The thermal storage capacity expressed in number of hours of thermal energy delivered at the power block's design thermal input level. The physical capacity is the number of hours of storage multiplied by the power block design thermal input. Used to calculate the TES maximum storage capacity.

### Storage System Configuration

The current version of SAM models a two-tank TES consisting of a cold storage tank and hot storage tank.

### Storage Fluid Type

The storage fluid, used to determine the heat-exchanger duty.

When the storage fluid and solar field heat transfer fluid (HTF) are different, the system is an indirect system. When the storage fluid and solar field HTF are the same, the system is a direct system that uses the solar field HTF as the storage medium.

### Turbine TES Adj Efficiency

SAM applies the TES efficiency adjustment factor to the turbine efficiency for trough systems with storage to account for the lower steam temperature that results from imperfect heat exchange in the storage system. Used to calculate maximum TES discharge rate. Also used to calculate a TES correction factor.

### Turbine TES Adj Gross Output

Efficiency adjustment factor. Used to calculate maximum TES discharge rate.

### Initial Thermal Storage (MWht)

The amount of energy in storage when the simulation starts, at midnight on January 1. The default value is zero.

### Tank Heat Losses (MWht)

Storage tank thermal losses. SAM subtracts value from the total energy in storage at the end of each simulation hour. See the table below for suggested values.

An increase in the hours of thermal storage requires a both an increase in the solar field size to minimize the [levelized cost of energy \(LCOE\)](#) for the system, and an increase in the tank heat losses to account for the larger tank.

The following table shows suggested tank heat loss values for three sample systems over a range of thermal storage capacities. The relationship between tank heat losses and hours of thermal storage is linear, so you can extrapolate to estimate values for storage capacity values not on the table.

System Description	Hours of Thermal Storage					
	0	3	6	9	12	15
100 MW Two Tank Indirect VP-1/Nitrate Salt	0	0.62	0.96	1.23	1.56	1.87
200 MW Two Tank Indirect VP-1/Nitrate Salt	0	1.0	1.61	2.21	2.81	3.56
200 MW Two Tank Direct Hitec Salt	0	0.34	0.64	0.93	1.24	1.52

**Maximum Energy Storage (MWht)**

The maximum thermal energy storage capacity of the TES.

$$\text{Maximum Energy Storage} = \text{Equiv. Full Load Hours of TES} \times \text{Design Turbine Thermal Input}$$

**Design Turbine Thermal Input (MWt)**

The thermal input requirement of the power block to operate at its design point. Used to calculate the following dispatch parameters: power block input limits, power block load requirement, TES maximum storage capacity, and the start-up requirement

**Max Power to Storage (MWt)**

Maximum TES charge rate. Used in the dispatch calculation when energy from the solar field exceeds the power block load requirement.

When Storage Fluid Type is different from Solar Field HTF Type on the Solar Field page, SAM assumes that the TES includes a heat exchanger, and Heat Exchanger Duty > 1:

$$\text{Max Power to Storage} = \text{Heat Exchanger Duty} \times \text{Design Turbine Thermal Input}$$

When the TES and Solar Field fluids are the same, SAM assumes there is no heat exchanger, and Heat Exchanger Duty = 1:

$$\text{Max Power to Storage} = \text{Solar Multiple Calc} \times \text{Max Turbine Over Design Operation} \times \text{Design Turbine Thermal Input}$$

Where Design Turbine Thermal Input is the Design Cycle Thermal Input value from the [Power Block](#) page, Max Turbine Over Design Operation is from the Power Block page, and Solar Multiple Calc is from the [Solar Field](#) page.

**Max Power From Storage (MWt)**

Maximum TES discharge rate. Used in the dispatch calculation when energy from the solar field is less or equal to than the power block load requirement.

When Storage Fluid Type is different from Solar Field HTF Type on the Solar Field page, SAM assumes that the TES includes a heat exchanger, and Heat Exchanger Duty > 1:

$$\text{Max Power From Storage} = \text{Maximum Power to Storage} \times (\text{Turbine TES Adj Gross Output} \div \text{Turbine TES Adj Efficiency})$$

When the TES and Solar Field fluids are the same, SAM assumes there is no heat exchanger, and Heat Exchanger Duty = 1:

$$\text{Max Power From Storage} = \text{Design Turbine Thermal Input} \times \text{Max Turbine Over Design Operation} \times (\text{Turbine TES Adj Gross Output} \div \text{Turbine TES Adj Efficiency})$$

Where Design Turbine Thermal Input is the Design Cycle Thermal Input value from the [Power Block](#) page, Max Turbine Over Design Operation is from the Power Block page.

**Heat Exchanger Duty**

Applies only to indirect thermal storage systems that use a different storage fluid and solar field HTF. Used to calculate the maximum TES charge rate.

When the solar multiple is greater than one:

$$\text{Heat Exchanger Duty} = \text{Solar Multiple Calc} - 1$$

When the solar multiple is equal to or less than one:

$$\text{Heat Exchanger Duty} = 0$$

Where Solar Multiple Calc is from the [Solar Field](#) page.

## Thermal Storage Dispatch Control

The thermal storage dispatch control variables determine how energy is dispatched from the TES, what load level the power block and optional backup boiler operate, and the times that the optional PPA power price multipliers apply.

### Current Dispatch Schedule

The name of the dispatch schedule displayed in the Weekday and Weekend schedule matrices.

### Dispatch Schedule Library

Click to choose a dispatch schedule from the library. See [Storage and Fossil Dispatch Controls](#) for details.

The storage dispatch control variables each have six values, one for each of six possible dispatch periods. They determine how SAM calculates the energy flows between the solar field, thermal energy storage system, and power block. The fossil-fill fraction is used to calculate the energy from a backup boiler.

### Storage Dispatch Fraction with Solar

The fraction of the TES maximum storage capacity indicating the minimum level of charge that the storage system can discharge to while the solar field is producing power. A value of zero will always dispatch the TES in any hour assigned to the given dispatch period; a value of one will never dispatch the TES. Used to calculate the storage dispatch levels.

### Storage Dispatch Fraction without Solar

The fraction of the TES maximum storage capacity indicating the minimum level of charge that the storage system can discharge to while no solar resource is available. A value of zero will always dispatch the TES in any hour assigned to the given dispatch period; a value of one will never dispatch the TES. Used to calculate the storage dispatch levels.

### Turbine Output Fraction

The fraction of design-point thermal load to the power block before part-load and temperature efficiency corrections. These values allow the user to dispatch the power cycle at a desired level according to the time-of-dispatch period.

### Fossil Fill Fraction

A fraction of the power block design turbine gross output from the Power Block page that can be met by the backup boiler. Used by the power block module to calculate the energy from the backup boiler.

If you specify a fossil fill fraction other than zero for one or more periods and want to account for fuel costs in the financial model, you should assign a fossil fuel cost under Operation and Maintenance costs on the [System Costs](#) page.

## Storage and Fossil Dispatch Controls

The thermal storage dispatch controls determine the timing of releases of energy from the thermal energy storage and fossil backup systems to the power block. When the system includes thermal energy storage or fossil backup, SAM can use a different dispatch strategy for up to six different dispatch periods.

## Storage Dispatch

SAM decides whether or not to operate the power block in each hour of the simulation based on how much energy is stored in the TES, how much energy is provided by the solar field, and the values of the thermal storage dispatch controls parameters. You can define when the power block operates for each of the six dispatch periods. For each hour in the simulation, if the power block is not already operating, SAM looks at the amount of energy that is in thermal energy storage at the beginning of the hour and decides whether it should operate the power block. For each period, there are two targets for starting the power block: one for periods of sunshine (w/solar), and one for period of no sunshine (w/o solar).

The turbine output fraction for each dispatch period determines at what load level the power block runs using energy from storage during that period. The load level is a function of the turbine output fraction, design turbine thermal input, and the five turbine part load electric to thermal factors on the [Power Block page](#).

For each dispatch period during periods of sunshine, thermal storage is dispatched to meet the power block load level for that period only when the thermal power from the solar field is insufficient and available storage is equal to or greater than the product of the storage dispatch fraction (with solar) and maximum energy in storage. Similarly, during periods of no sunshine when no thermal power is produced by the solar field, the power block will not run except when the energy available in storage is equal to or greater than the product of storage dispatch fraction (without solar) and maximum energy in storage.

By setting the thermal storage dispatch controls parameters, you can simulate the effect of a clear day when the operator may need to start the plant earlier in the day to make sure that the storage is not filled to capacity and solar energy is dumped, or of a cloudy day when the operator may want to store energy for later use in a higher value period.

## Fossil Dispatch

When the fossil fill fraction is greater than zero for any dispatch period, the system is considered to include fossil backup. The fossil fill fraction defines the solar output level at which the backup system runs during each hour of a specific dispatch period. For example, a fossil fill fraction of 1.0 would require that the fossil backup operate to fill in every hour during a specified period to 100% of design output. In that case, during periods when solar is providing 100% output, no fossil energy would be used. When solar is providing less than 100% output, the fossil backup operates to fill in the remaining energy so that the system achieves 100% output. For a fossil fill fraction of 0.5, the system would use energy from the fossil backup only when solar output drops below 50%.

The boiler LHV efficiency value on the [Power Block page](#) determines the quantity of fuel used by the fossil backup system. A value of 0.9 is reasonable for a natural gas-fired backup boiler. SAM includes the cost of fuel for the backup system in the [levelized cost of energy \(LCOE\)](#) and other metrics reported in the results, and reports the energy equivalent of the hourly fuel consumption in the [time series](#) simulation results. The cost of fuel for the backup system is defined on the [Trough System Costs page](#).

## Defining Dispatch Schedules

The storage dispatch schedules determine when each of the six periods apply during weekdays and weekends throughout the year. You can either choose an existing schedule from one of the schedules in the CSP trough TES dispatch library or define a custom schedule.

If your analysis includes [PPA price multipliers](#) and you want to use the same schedule for the multipliers and for the power cycle dispatch control, click **Copy schedule from TOD Factors** page to apply the TOD Factors schedule matrices to the dispatch schedule matrices.



**To specify a weekday or weekend schedule:**

1. Assign values as appropriate to the Storage Dispatch, Turbine Output Fraction, and Fossil Fill Fraction for each of the up to nine periods.
2. Use your mouse to draw a rectangle in the matrix for the first block of time that applies to period 2.

	12am	1am	2am	3am	4am	5am	6am	7am	8am	9am	10am	11am	12pm	1pm	2pm	3pm	4pm	5pm	6pm	7pm	8pm	9pm	10pm	11pm
Jan	1	1	1	1	1	1	1	1	1	1	1	1	1	1	1	1	1	1	1	1	1	1	1	1
Feb	1	1	1	1	1	1	1	1	1	1	1	1	1	1	1	1	1	1	1	1	1	1	1	1
Mar	1	1	1	1	1	1	1	1	1	1	1	1	1	1	1	1	1	1	1	1	1	1	1	1
Apr	1	1	1	1	1	1	1	1	1	1	1	1	1	1	1	1	1	1	1	1	1	1	1	1
May	1	1	1	1	1	1	1	1	1	1	1	1	1	1	1	1	1	1	1	1	1	1	1	1
Jun	1	1	1	1	1	1	1	1	1	1	1	1	1	1	1	1	1	1	1	1	1	1	1	1
Jul	1	1	1	1	1	1	1	1	1	1	1	1	1	1	1	1	1	1	1	1	1	1	1	1
Aug	1	1	1	1	1	1	1	1	1	1	1	1	1	1	1	1	1	1	1	1	1	1	1	1
Sep	1	1	1	1	1	1	1	1	1	1	1	1	1	1	1	1	1	1	1	1	1	1	1	1
Oct	1	1	1	1	1	1	1	1	1	1	1	1	1	1	1	1	1	1	1	1	1	1	1	1
Nov	1	1	1	1	1	1	1	1	1	1	1	1	1	1	1	1	1	1	1	1	1	1	1	1
Dec	1	1	1	1	1	1	1	1	1	1	1	1	1	1	1	1	1	1	1	1	1	1	1	1

3. Type the number 2.

	12am	1am	2am	3am	4am	5am	6am	7am	8am	9am	10am	11am	12pm	1pm	2pm	3pm	4pm	5pm	6pm	7pm	8pm	9pm	10pm	11pm
Jan	1	1	1	1	1	1	1	1	1	1	1	1	1	1	1	1	1	1	1	1	1	1	1	1
Feb	1	1	1	1	1	1	1	1	1	1	1	1	1	1	1	1	1	1	1	1	1	1	1	1
Mar	1	1	1	1	1	1	1	1	1	1	1	1	1	1	1	1	1	1	1	1	1	1	1	1
Apr	1	1	1	1	1	1	1	1	1	1	1	1	1	1	1	1	1	1	1	1	1	1	1	1
May	1	1	1	1	1	1	1	1	1	1	2	2	2	2	2	2	1	1	1	1	1	1	1	1
Jun	1	1	1	1	1	1	1	1	1	1	2	2	2	2	2	2	1	1	1	1	1	1	1	1
Jul	1	1	1	1	1	1	1	1	1	1	2	2	2	2	2	2	1	1	1	1	1	1	1	1
Aug	1	1	1	1	1	1	1	1	1	1	2	2	2	2	2	2	1	1	1	1	1	1	1	1
Sep	1	1	1	1	1	1	1	1	1	1	1	1	1	1	1	1	1	1	1	1	1	1	1	1
Oct	1	1	1	1	1	1	1	1	1	1	1	1	1	1	1	1	1	1	1	1	1	1	1	1
Nov	1	1	1	1	1	1	1	1	1	1	1	1	1	1	1	1	1	1	1	1	1	1	1	1
Dec	1	1	1	1	1	1	1	1	1	1	1	1	1	1	1	1	1	1	1	1	1	1	1	1

4. SAM shades displays the period number in the squares that make up the rectangle, and shades the rectangle to match the color of the period.

**Thermal Storage Dispatch Control**

Current dispatch schedule:  
 No library match.  
 Dispatch schedule library...

Note:  
 Schedule libraries do not affect the Storage Dispatch, Turbine Output and Fossil Fill fractions below.

	Storage Dispatch		Turb. out.	Fossil fill	Payment
	w/ solar*	w/o solar*	fraction*	fraction*	Allocation Factor
Period 1:	0	0	1.1	0	1
Period 2:	0	0	1	0.5	1
Period 3:	0	0	1	0	1
Period 4:	0	0	1	0	1
Period 5:	0	0	1	0	1
Period 6:	0	0	1	0	1
Period 7:	0	0	1	0	1
Period 8:	0	0	1	0	1
Period 9:	0	0	1	0	1

**Weekday Schedule**

	12am	1am	2am	3am	4am	5am	6am	7am	8am	9am	10am	11am	12pm	1pm	2pm	3pm	4pm	5pm	6pm	7pm	8pm	9pm	10pm	11pm
Jan	1	1	1	1	1	1	1	1	1	1	1	1	1	1	1	1	1	1	1	1	1	1	1	1
Feb	1	1	1	1	1	1	1	1	1	1	1	1	1	1	1	1	1	1	1	1	1	1	1	1
Mar	1	1	1	1	1	1	1	1	1	1	1	1	1	1	1	1	1	1	1	1	1	1	1	1
Apr	1	1	1	1	1	1	1	1	1	1	1	1	1	1	1	1	1	1	1	1	1	1	1	1
May	1	1	1	1	1	1	1	1	1	1	2	2	2	2	2	2	1	1	1	1	1	1	1	1
Jun	1	1	1	1	1	1	1	1	1	1	2	2	2	2	2	2	1	1	1	1	1	1	1	1
Jul	1	1	1	1	1	1	1	1	1	1	2	2	2	2	2	2	1	1	1	1	1	1	1	1
Aug	1	1	1	1	1	1	1	1	1	1	2	2	2	2	2	2	1	1	1	1	1	1	1	1
Sep	1	1	1	1	1	1	1	1	1	1	1	1	1	1	1	1	1	1	1	1	1	1	1	1
Oct	1	1	1	1	1	1	1	1	1	1	1	1	1	1	1	1	1	1	1	1	1	1	1	1
Nov	1	1	1	1	1	1	1	1	1	1	1	1	1	1	1	1	1	1	1	1	1	1	1	1
Dec	1	1	1	1	1	1	1	1	1	1	1	1	1	1	1	1	1	1	1	1	1	1	1	1

**Weekend Schedule**

	12am	1am	2am	3am	4am	5am	6am	7am	8am	9am	10am	11am	12pm	1pm	2pm	3pm	4pm	5pm	6pm	7pm	8pm	9pm	10pm	11pm
Jan	1	1	1	1	1	1	1	1	1	1	1	1	1	1	1	1	1	1	1	1	1	1	1	1
Feb	1	1	1	1	1	1	1	1	1	1	1	1	1	1	1	1	1	1	1	1	1	1	1	1
Mar	1	1	1	1	1	1	1	1	1	1	1	1	1	1	1	1	1	1	1	1	1	1	1	1
Apr	1	1	1	1	1	1	1	1	1	1	1	1	1	1	1	1	1	1	1	1	1	1	1	1

- Repeat Steps 2-4 for each of the remaining periods that apply to the schedule.

## 18.6.6 Parasitics

To view the Parasitics page, click **Parasitics** on the main window's navigation menu. Note that for the empirical trough input pages to be available, the technology option in the [Technology and Market](#) window must be Concentrating Solar Power - Empirical Trough System.

The Parasitics page displays parameters describing losses due to parasitic electrical loads, such as drive motors, electronic circuits, and pump motors. SAM includes a set of default parasitic parameters for a range of solar trough power systems. Choose a reference parasitic system option that is the same or similar to the system you are modeling. SAM will automatically adjust the total parasitic load to match the size of the solar field and power block in the system you are modeling.

The design point parasitic values are the maximum possible values for each parasitic loss category. SAM calculates the hourly parasitic loss value for each category during simulation based on the design point, the PF and F0-F2 coefficients, and the solar field thermal output and power block load in each hour, and reports them in the [time series](#) simulation results. The calculated parasitic loss values are never as high as the total design point parasitic losses.

For a more detailed description of the model, please download the CSP trough reference manual from the [SAM website](#).

The values of input variables on the Parasitics page are stored in a library of reference solar fields. You can change the parameter values without changing the values stored in the library. For information about libraries, See [Working with Libraries](#).

### Parasitic Electric Energy Use

#### Current reference parasitic system

The reference system from the CSP trough parasitics library. SAM stores a set of parasitic parameters for reference systems.

**Solar Field Area (m<sup>2</sup>)**

The calculated solar field area from the [Solar Field page](#). Used to calculate parasitic losses that are based on the solar field size with units of MWe/m<sup>2</sup>.

**Gross Turbine Output (MWe)**

The design turbine gross output value from the [Power Block page](#). Used to calculate parasitic losses that are based on the power block capacity with units of MWe/MWe.

**SCA Drives and Electronics (MWe)**

Electrical losses from electric or hydraulic SCA drives that position the collector to track the sun and from electronic SCA tracking controllers and alarm monitoring devices. For hours when the solar field is operating, SAM calculates the loss as the product of the value you specify and the solar field area. For hours when the solar field is not operating, the value of the loss is zero.

**Note.** SAM does not use the "PF" value for the SCA Drives and Electronics loss calculation.

**Solar Field HTF Pumps**

Electrical losses from cold HTF pumping in the solar field. Calculated as a function of the solar field area. These losses are calculated only in hours when the solar field is operating, which is defined as when the solar field load is greater than zero.

$$\text{Solar Field HTF Pumps Parasitic} = \text{Design Point} * \left[ F0 + F1 \frac{Q_{sf}}{Q_{sf,design}} + F2 \left( \frac{Q_{sf}}{Q_{sf,design}} \right)^2 \right]$$

**TES Pumps**

Electrical losses from pumps in the TES system. Calculated as a function of the design turbine gross output.

**Antifreeze Pumping (MWe)**

Electrical losses from HTF pumps in the solar field. Calculated as a function of the solar field area, calculated as a fraction of the solar field HTF pumps design point parasitic loss. These losses are used only in hours when the solar field is not operating, which is defined as when the solar field load is zero.

**Power Block Fixed (MWe)**

These fixed losses apply 24 hours per day, for all of the 8,760 hours of the year.

**Balance of Plant (MWe)**

Electrical losses that apply in hours when the power block operates at part or full load.

**Heater and Boiler (MWe)**

Losses that apply only when the back-up boiler is in operation.

**Cooling Towers (MWe)**

The cooling tower parasitic losses are electrical losses that occur when the power block operates at part or full load. Calculated either as a function of power block load or at a fixed 50% or 100% of the design cooling tower parasitic losses.

**Cooling Tower Operation Mode**

Determines how cooling tower parasitic losses are calculated. For "Cooling Tower at 50% or 100%," parasitic losses are calculated as 50% of the design cooling tower parasitic losses when the power block load is 0.5 or less, and as or 100% of the design parasitic losses when the power block load is

greater than 0.5. For "Cooling Tower parasitics a function of load," cooling tower parasitic losses are calculated as a function of power block load.

### Total Design Parasitics (MWe)

The sum of collector drives and electronics, solar field HTF pump, night circulation pumping, power block fixed, balance of plant, heater/boiler, and cooling towers design loss values. This value represents the maximum possible value if all parasitic losses were to occur simultaneously in a given hour, and is typically greater than the actual parasitic losses. SAM displays the value for reference only, and does not use it in simulation calculations.

Each parasitic loss type has a set of parameters that includes a factor, PF and F0, F1, and F2 coefficient. The design point values are maximum values and are calculated using the factor and PF coefficient. SAM uses the F0-F2 coefficients in calculations for the hourly simulations, which are described in the reference manual.

**Table . Design point parasitic loss equations for each parasitic loss category.**

Source of Parasitic Loss	Equation
SCA Drives and Electronics	<i>Factor x PF x Solar Field Area</i>
Solar Field HTF Pumps	<i>Factor x PF x Solar Field Area</i>
TES Pumps	<i>Factor x PF x Gross Turbine Output</i>
Antifreeze Pumping	<i>Factor x Solar Field HTF Pump losses</i>
Power Block Fixed	<i>Factor x Gross Turbine Output</i>
Balance of Plant	<i>Factor x PF x Gross Turbine Output</i>
Heater and Boiler	<i>Factor x PF x Gross Turbine Output</i>
Cooling Towers	<i>Factor x PF x Gross Turbine Output</i>

The Total Design Point Parasitics is the sum of the design point parasitic loss categories:

- SCA Drives and Electronics
- Solar Field HTF Pumps
- TES Pumps
- Power Block Fixed
- Balance of Plant
- Heater and Boiler
- Cooling Towers

## 19 CSP Power Tower

A power tower system (also called a central receiver system) is a type of concentrating solar power (CSP) system that consists of a heliostat field, tower and receiver, power block, and optional thermal energy storage system. The field of flat, sun-tracking mirrors called heliostats focus direct normal solar radiation onto a receiver at the top of the tower, where a heat-transfer fluid is heated and pumped to the power block. The power block generates steam that drives a conventional steam turbine and generator to convert the thermal energy to electricity.

The code for SAM's power tower performance model, including the Rankine cycle model, is adapted from the model developed at the University of Wisconsin and described in *Simulation and Predictive Performance Modeling of Utility-Scale Central Receiver System Power Plants*, Wagner (2008) ([ZIP 32 MB](#)).

The solar field optimization algorithm uses [SolarPILOT™](#) to generate the heliostat field layout and characterize optical performance.

For additional technical documentation, see the [SAM website](#).

### Notes.

In versions of SAM released after November 2020, the supercritical Carbon dioxide (sCO<sub>2</sub>) option is not available on the Power Cycle page. It is replaced by the **sCO<sub>2</sub> Cycle Integration macro** with the [NREL Supercritical Carbon Dioxide \(sCO<sub>2</sub>\) Python model](#). To use the older sCO<sub>2</sub> cycle option in SAM, you can use the legacy version SAM 2020.2.29, available on the SAM website [Download page](#)

In versions of SAM released after June 2015, thermocline storage, and fossil backup are not available because they were not incorporated into the new dispatch controller logic at the time of the software release. If you want to use those features, you can use the legacy version SAM 2015.6.30, available on the SAM website [Download page](#).

### 19.1 Location and Resource

The Location and Resource page provides access to the solar resource library, which is a collection of weather files stored on your computer. When you first install SAM, it comes with a few default weather files in the library. As you use SAM for your own projects, you should add files to build your own library. Once files are in your library, you can use them for different projects and with different versions of SAM.

**Solar Resource Library**  
The Solar Resource library is a list of weather files that you can use for simulation, or use the tools below to add files to the library.

Search for:  Name

Name	Latitude	Longitude	Time zone	Elevation	Station ID
daggett_ca_34.865371_-116.783023_psmv3_60_tmy	34.85	-116.78	-8	561	91486
des_moines_ia_41.586835_-93.624959_psmv3_60_tmy	41.57	-93.62	-6	263	757516
faroo nd 46.9 -96.8 mts1 60 tmv	46.9	-96.8	-6	274	14914

SAM scans the following folders on your computer for valid weather files to add to the solar resource library. To use weather files stored on your computer, add folders containing the files.

C:\Users\<user>\SAM Downloaded Weather Files  
F:\little\_rock\_ar  
F:\PVGIS 5

**Choose a weather file from the library.**

**List of solar resource folders.**

**Weather file for simulation.**

**Weather Data Information**  
The following information describes the weather file selected from the Solar Resource library above. This is the file

Weather file: C:\SAM\2018.10.29\solar\_resource\daggett\_ca\_34.865371\_-116.783023\_psmv3\_60\_tmy.csv

**Header Data from Weather File**

City	Station ID	Latitude
-	91486	34.85 °N
State	Data Source	Longitude
-	NSRDB	-116.78 °E
Country	Elevation	Time zone
-	561 m	GMT -8

**Annual Averages Calculated from Weather File Data**

Global horizontal	NaN kWh/m <sup>2</sup> /day	Average temperature	17.3 °C
Direct normal (beam)	7.65 kWh/m <sup>2</sup> /day	Average wind speed	2.4 m/s
Diffuse horizontal	1.27 kWh/m <sup>2</sup> /day		

\*NaN indicates missing data.

**Information from weather file header.**

**Summary data calculated from time series data.**

There are two ways to add files to your solar resource library:

### 1. Download files from the NREL National Solar Radiation Database (NSRDB)

Use the download weather file options and click **Download and add to library** to get the most up-to-date data from the NSRDB for long-term cash flow analysis, single-year analysis, and P50/P90 analysis.

### 2. Add weather file folders

If you have weather files from a source other than the NSRDB or that you've downloaded yourself directly from the NSRDB website, click **Add/remove weather file folders** to add the folder containing the files to the **Solar Data File Folders** list. SAM automatically adds any weather files it finds in these folders to the solar resource library so they will appear in the list.

When you install SAM, it creates the default download folder <user>/SAM Downloaded Weather Files folder where weather files you download from the NSRDB are stored. You can change that folder by clicking **Add/remove weather file folders** and changing the **Folder for Downloaded Solar Data Files**.

For locations not in the NSRDB, you can download weather files in the EPW format from the European Commission Photovoltaic Geographical Information System [PVGIS V5 website](#).

### See also

[Weather File Formats](#)  
[Weather Data Elements](#)  
[Typical and Single Year](#)  
[Time and Sun Position](#)  
[Folders and Libraries](#)  
[Weather Data and LK](#)

**Notes.**

You may want to model your system using weather data from several different sources and locations around your project site to understand how sensitive your analysis results are to the weather assumptions, and how much variation there is in the data from the different weather files.

You can compare results for a system using more than one weather file in a single case by using SAM's [parametric simulation](#) option.

For more information about weather data, including where to find data for locations outside of the United States, see [Weather Data](#) on the SAM website.

For a helpful discussion of weather data and power system simulation, see Sengupta, M.; Habte, A.; Gueymard, C.; Wilbert, S.; Renne, D.; Stoffel, T. (2017). "Best Practices Handbook for the Collection and Use of Solar Resource Data for Solar Energy Applications: Second Edition." NREL Report No. TP-5D00-68886. ([PDF 8.1 MB](#))

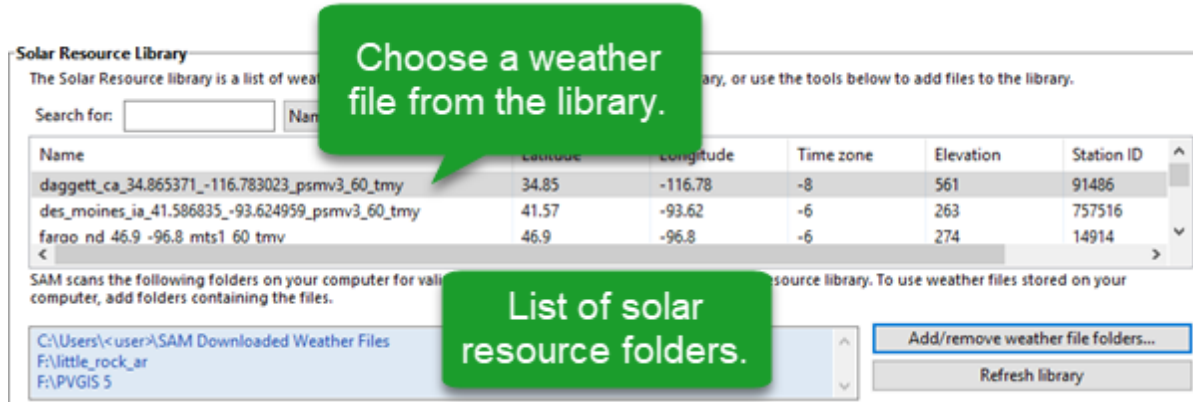
## ▼ Solar Resource Library

SAM's solar resource library displays information from weather files in your solar resource data folders. The default solar resource library that comes with SAM contains weather files for a few locations around the United States for the default configurations. As you use SAM, use **Add/remove weather file folders** to build a library of files for locations you frequently use as described in [Folders and Libraries](#).

**To choose a file from the solar resource library:**

- Click the location name in the list. You can type a few letters of the file name in the Search box to filter the list.

The full file name and information about the selected file appears under **Weather Data Information**. To see the data in the file, click **View data**.



### Add/remove weather file folders

Use the folder settings to tell SAM what folders on your computer it should scan for weather files to build the solar resource library. SAM adds any files it can identify as valid weather files in each folder you specify to the library.

Before adding a file to the library, SAM checks the data in the file displays a message if it finds any problems with the data in the file.

SAM will only add valid weather files to the library. If you add a folder that contains CSV files that are not in the SAM CSV format, it will not add those files to the library.

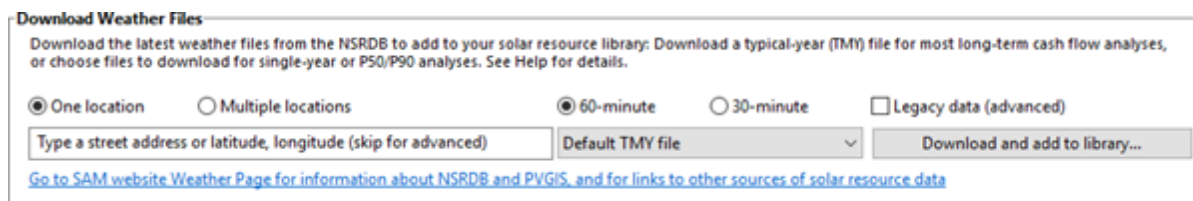
The list of solar resource folders are the folders that SAM scans for weather files to build the solar resource library.

### Refresh library

Refresh the library after adding files to the weather file folder. In most cases, SAM should automatically refresh the library as needed, but you may need to manually refresh it.

## Download Weather Files

SAM can download weather files from the latest National Solar Radiation Database (NSRDB) Physical Solar Model (PSM) datasets. For all NSRDB datasets, SAM can download single-year files or typical-year files.



**Note.** For locations not in the NSRDB, you can download EPW files from the European Commission Photovoltaic Geographical Information System [PVGIS V5 website](#) to a folder on your computer, and then use the [folder settings window](#) to add the folder to the list of folders SAM scans to build the solar resource library.

### To download a typical-year weather file for a single location:

1. Replace the text "Type a location name, street address or latitude and longitude" with a street address, city and state or country name, zip code, or latitude longitude pair. For example:



- Golden, Colorado
  - golden, co
  - 15013 Denver West Parkway, Golden CO 80401
  - 80401
  - thimpu, bhutan
2. Click **Download and add to library**.

For more instructions to download multiple files, see [Weather File Download Instructions](#) below.

SAM converts the address you type to a latitude and longitude pair for the location, and submits that information to the NSRDB along with your email address. If the location is in the region covered by the NSRDB, it returns a weather file in the SAM CSV format, and adds it to your weather file download folder. Otherwise, it displays a message telling you the location is not covered by the NSRDB.

When you first install SAM, it creates the *SAM Downloaded Weather Files* folder and assigns it as your weather file download folder. You can change the weather file download folder by clicking **Add/Remove weather file folders**. See [Folders and Libraries](#) for details.

When the download finishes, SAM displays a prompt asking you if you want to open the weather file download log. This prompt is the indication that the download finished. During the download and before that prompt appears, SAM may become unresponsive. If it does, wait for the prompt to avoid interrupting the download.

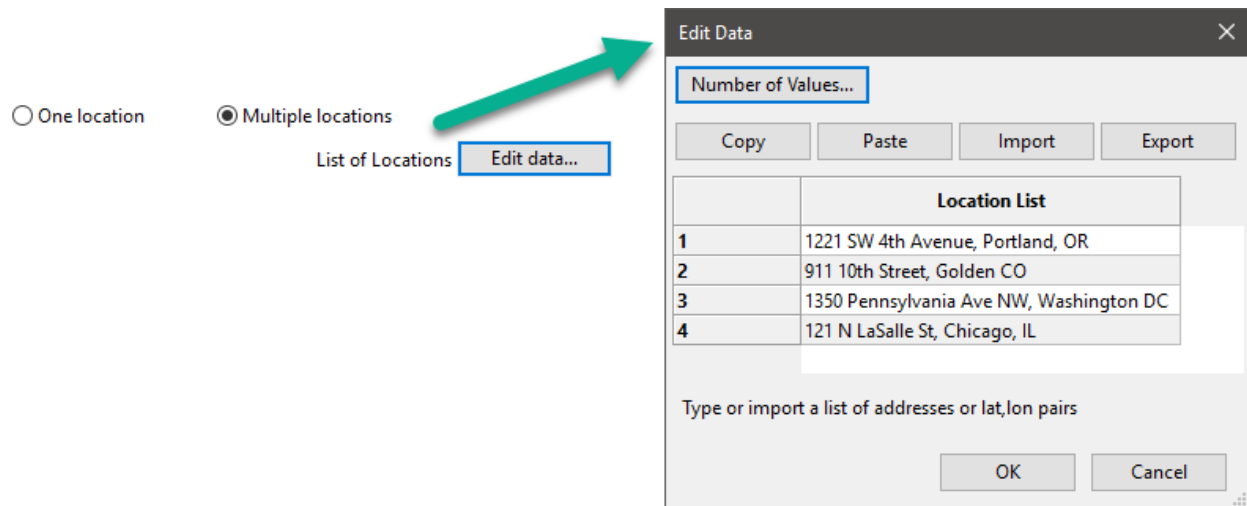
The weather file download log is a text file that SAM creates in your weather file download folder, and serves as a record of all of the files you download from the NSRDB. For each download, it lists the date and time of the request, the information you provided, the URL SAM generated, the name of the file returned by the NSRDB, or error messages it returns if the download fails. This information is useful for troubleshooting weather file download problems.

**Note.** Downloading multiple weather files from the NSRDB can take a long time. If you download files for multiple locations or years, be prepared to wait for the files to download. The download log file reports the time it takes for each file to download. Download times depend on your internet connection and computer. For a new computer with a fast connection, downloading and processing a single file takes about 10 seconds.

### One location, Multiple locations

Choose **One location** to download a weather file for a single location.

Choose **Multiple locations** to submit a list of locations and download a file or files for each location. For Multiple locations, click **Edit data** to open the Edit Data window where you can enter the list of locations and click **Number of Values** to enter the number of locations in the list.

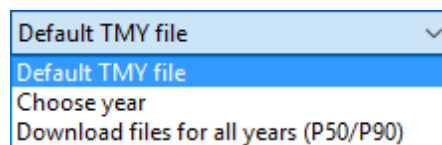


### 60-minute, 30-minute

Choose **60-minute** to download weather files with hourly time steps or 8,760 data records.

Choose **30-minute** to download files with 30-minute time steps or 17,520 data records. Thirty-minute data is not available for the NSRDB SUNY International dataset.

### Download options



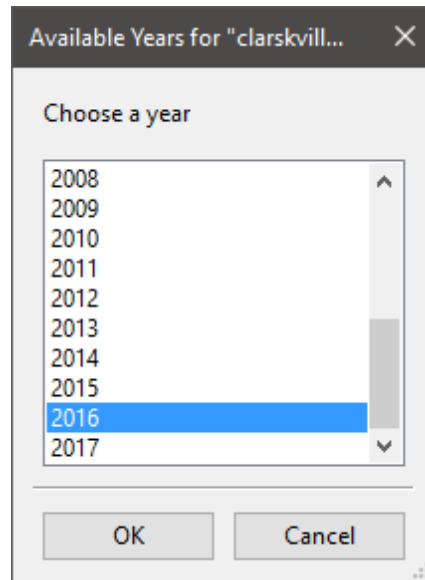
### Default TMY file

Download a typical meteorological year weather file for the location or locations you specified.

Typical year data is appropriate when you are using simulation results for a single year to make cash flow calculations over a multi-year period.

### Choose year

Choose a single year file to download. After you click the Download button, SAM prompts you with a list of available years for each location you requested to choose a year.



The single year option is appropriate when you want to see how the system would perform in a particular year. For example, for a residential or commercial system, if you have measured building load data for a given year, you could use weather data for the same year to see how the system's power output compares to the load.

If you use both **Choose year** and **Multiple locations**, SAM prompts you for a year for each location.

SAM queries the NSRDB to generate the list of available years. The list of available years varies between regions.

### Download files for all years (P50/P90)

Download a set of single-year files covering the range of historical data (nineteen files for 1998 through 2017 as of October 2018 for PSM data). When you click download, SAM creates a folder in your weather file download folder to store the single year files based on the location address or latitude-longitude pair you typed. It also downloads the typical meteorological year (TMY) file for the location and stores it in your weather file download folder.

SAM appends an underscore with the year to the file name so that the P50 P90 simulations work correctly. See [P50/P90 Simulations](#) for details.

If you choose to download files for all years with **Multiple locations**, SAM downloads a set of files for each location, and puts the files for each location in a separate folder. Note that this may take a long time.

## Weather File Download Instructions

### Examples of valid street address or latitude-longitude pairs:

- golden colorado
- golden, co
- 15013 Denver West Parkway, Golden CO 80401
- 80401
- 39.75, -105.15

- Super Market, F-6 Markaz, Islamabad, Pakistan
- New Delhi, India

**Note.** When the download finishes, SAM displays a prompt asking you if you want to open the weather file download log. This prompt is the indication that the download finished. During the download and before that prompt appears, SAM may become unresponsive. If it does, wait for the prompt to avoid interrupting the download.

**To download an hourly typical-year (TMY) weather file from the NSRDB (use this option for most situations):**

1. Click **One location**.
2. Type either a street address or latitude-longitude pair.
3. Click **60-minute**.
4. Choose **Default TMY File**.
5. Click **Download and add to library**.

**To download files for more than one location:**

1. Click **Multiple locations**.
2. Click **Edit data**.
3. In the Edit Data window, click **Number of Values** and type the number of locations to create a table with a row for each location.
4. Type a street address or latitude-longitude pair in the table for each location.
5. Click **OK**.
6. Choose a time step, **60-minute** for hourly, or **30-minute** for 30-minute data.
7. Choose the type of file(s) you want to download as described below.
8. Click **Download and add to library**.

## Weather Data Information

**Weather Data Information**  
The following information describes the weather file in the Solar Resource library above. This is the file SAM will use when you click Simulate.

Weather file:  [View data](#)

**-Header Data from Weather File-**

City	<input type="text" value="-"/>	Station ID	<input type="text" value="91486"/>	Latitude	<input type="text" value="34.85 *N"/>
State	<input type="text" value="-"/>	Data Source	<input type="text" value="NSRDB"/>	Longitude	<input type="text" value="-116.78 *E"/>
Country	<input type="text" value="-"/>	Elevation	<input type="text" value="561 m"/>	Time zone	<input type="text" value="GMT -8"/>

**-Annual Averages Calculated from Weather File Data-**

Global horizontal	<input type="text" value="NaN"/>	kWh/m <sup>2</sup> /day	Average temperature	<input type="text" value="17.3"/>	°C
Direct normal (beam)	<input type="text" value="7.65"/>	kWh/m <sup>2</sup> /day	Average wind speed	<input type="text" value="2.4"/>	m/s
Diffuse horizontal	<input type="text" value="1.27"/>	kWh/m <sup>2</sup> /day	*NaN indicates missing data.		

### Weather File

The path and name of the active weather file SAM will use for simulation. Download a different file from the NSRDB, or click a different file name in the library to change the file.

### View data

Display weather file data in the [time series data viewer](#).

**Note.** You can also see the data after running a simulation on the Results page [data tables](#) and [time series graphs](#).

### Header Data from Weather File

Header data is information in the weather file that describes the location and type of data in the file. SAM uses the time zone, elevation, latitude and longitude to calculate the sun position during simulations. It does not use the city, state, country, and other descriptive information.

### Annual Values Calculated from Weather File

When you add a weather file to the solar resource library, SAM reads weather data from the file and calculates the annual values to display for your reference. It does not use annual values during simulations.

#### Global horizontal, Direct normal (beam), Diffuse horizontal

The sum of solar irradiance data (W/m<sup>2</sup>) in the weather file converted to kW and divided by 365 days/year.

#### Average temperature

The sum of temperature data (°C) in the weather file divided by the number of records in the file (8760 for hourly data).

#### Average wind speed

The sum of wind speed data (m/s) in the weather file divided by the number of records in the file (8760 for hourly data).

### Maximum snow depth

If the weather file contains snow depth data, the maximum value of snow depth data (cm) in the weather file. NaN indicates the file does not contain snow depth data. Snow depth data is required for to model snow losses for the Detailed Photovoltaic and PVWatts models.

**Note.** For information about where to find weather files with snow depth data, see the note on the [Weather Data](#) page of the SAM website.

### Annual albedo

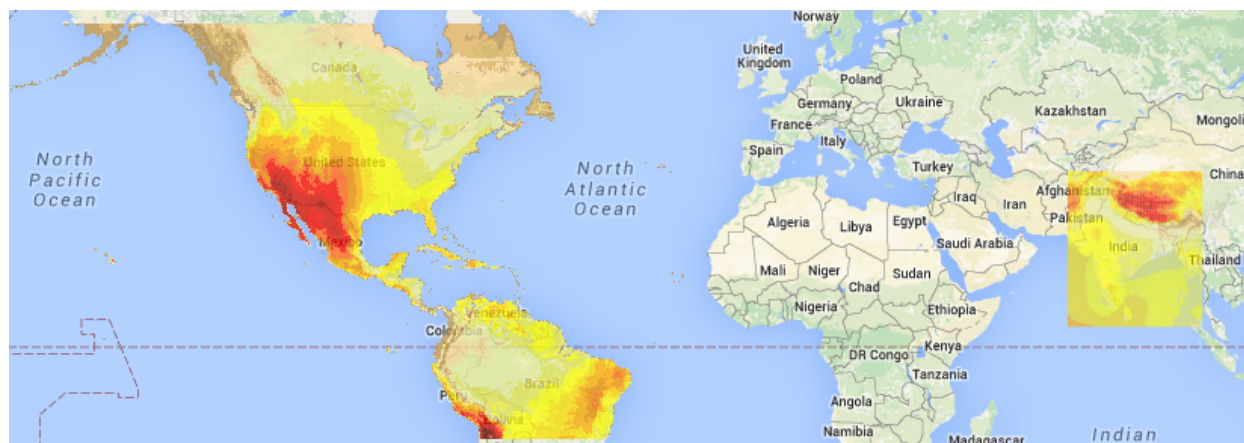
If the weather file contains albedo (ground reflectance) data, the average value of albedo values in the weather file. NaN indicates the file does not contain albedo data.

## ▼ About the NSRDB

The [NREL National Solar Radiation Database \(NSRDB\)](#) is an online database of weather files containing solar resource data in the [SAM CSV format](#). Files are available both as [typical-year](#) files and [single-year](#) files. The database covers the parts of the Americas and Asia shown in the map below. The current data is called PSM (Physical Solar Model) for the U.S., and SUNY for Asia. For details about the data see these pages on the NSRDB website:

- [U.S. data](#)
- [International data](#)

The NSRDB also contains legacy datasets for the U.S. from older versions of the NSRDB, including MTS3 (TMY3 1991-2010), MTS2 (TMY3 1991-2005), and MTS1 (TMY2 1961-1990). We recommend that you use the latest PSM data for your work in SAM, but the older data is available if you need it.



**Important Note for CSP Modelers!** SAM's CSP models assume that each DNI value in the weather file represents the average irradiance over the time step, and calculate sun angles for the midpoint of the time step. In weather files from the NSRDB, the irradiance data is measured instantaneously at either the beginning of the hour (TMY data), midpoint of the hour (single-year data), or beginning of the 30-minute time step (30-minute single-year data). As a result, if you use an NSRDB PSM weather file with a CSP model with either hourly TMY data or 30-minute single-year data, the sun angle for each time step will be for a different time than the time for the instantaneous irradiance values. See [Time Convention and Sun Position](#) for details.

**Notes.**

The NSRDB requires an email address to download weather file. When you download a weather file from SAM, SAM submits the email address that you used to [register SAM](#). NREL uses your email address to determine how many people are using the NSRDB. It does not share email addresses.

Different types of weather files in the NSRDB use different time conventions. See [Time Convention and Sun Position](#) for details.

When you download a file from the NSRDB website, SAM displays a "-" for the City, State, and Country fields because the NSRDB files do not contain that information. This will not affect simulation results. The location information SAM requires for simulations is latitude, longitude, elevation and time zone.

SAM uses the [Google Maps API Geocoding Service](#) service to identify the geographic coordinates (latitude and longitude) of a location when you type a street address or city and state name to identify the location.

For information about downloading weather files and data from other sources, see the [Weather Data](#) page on the SAM website.

SAM downloads weather files with the following hourly data from the NSRDB:

- Direct normal (beam) irradiance, DNI (W/m<sup>2</sup>)
- Diffuse horizontal irradiance, DHI (W/m<sup>2</sup>)
- Dry-bulb temperature (°C)
- Dew-point temperature (°C)
- Relative humidity (%), for single-year files only
- Atmospheric pressure (mbar)
- Wind speed at 2 meters above the ground (m/s)
- Wind direction (°E of N)
- Albedo

**Note.** Weather files with snow depth data for the Detailed Photovoltaic model are not available from the NSRDB PSM dataset. They are available for 239 locations in the United States from the legacy [MTS1 \(TMY2\) files in the original format](#), which cover the period 1961 - 1990. See [Snow Losses](#) for details.

## 19.2 System Design

The System Design page shows inputs for design point parameters that determine the system's nameplate capacity. Use the System Design inputs to define the nominal ratings of the system, and then specify details for each part of the system on the appropriate input pages.

**Notes.**

All of the system design inputs are nominal values, or values at the system's design point. SAM calculates actual values during simulation and reports them in the [results](#).

When you change the value of the following input variables, you should optimize the field geometry on the [Heliostat Field](#) page to be sure that the solar field geometry (number and position of heliostats, tower height, and receiver height and aspect ratio) is appropriate for the new value: **Design point DNI, Solar multiple, Design turbine gross output, Cycle thermal efficiency.**

## Heliostat Field

### Design-point DNI, W/m<sup>2</sup>

The direct normal irradiance (DNI) available at the design point.

Increasing this value indicates that fewer heliostats are needed to achieve the reference condition power, while decreasing this value has the opposite effect. The design-point DNI value should represent the DNI at which your plant should achieve the specified thermal rating, including thermal and piping losses

For design-point calculations involving solar irradiance, SAM uses the design-point DNI value with the sun position at noon on the summer solstice (June 21 north of the equator, and December 21 south of the equator).

## Tower and Receiver

### Solar multiple

The solar multiple determines the receiver's nominal thermal power. It is the ratio of the receiver thermal power to the cycle thermal power. For a system with no storage, the solar multiple should be close to or equal to one.

### Receiver thermal power, MWt

The thermal power required at the receiver outlet for the power cycle to operate at its design point.

$$\text{Receiver Thermal Power (MWt)} = \text{Solar Multiple} \times \text{Cycle Thermal Power (MWt)}$$

### HTF hot temperature, °C

The temperature of the hot heat transfer fluid at the receiver outlet when the power cycle operates at its design point.

### HTF cold temperature, °C

The temperature of the cold heat transfer fluid at the receiver inlet when the power cycle operates at its design point.

## Thermal Storage

### Full load hours of storage, hours

The nominal thermal storage capacity expressed in hours at full load: The number of hours that the storage system can supply energy at the cycle's design point.

SAM displays the equivalent storage capacity in MWht on the [System Costs](#) page.



**Solar field hours of storage, hours**

The nominal thermal storage capacity expressed in hours of the solar field's design thermal power output.

$$\text{Solar Field Hours of Storage} = \text{Full Load Hours of Storage} \div \text{Solar Multiple}$$

**Power Cycle****Design turbine gross output, MWe**

The power cycle's electrical output at the design point, not accounting for parasitic losses. This value together with the gross-to-net conversion factor and nominal cycle thermal efficiency determines the nominal cycle thermal power.

**Estimated gross-to-net conversion factor**

An estimate of the ratio of the electric energy delivered to the grid to the power cycle gross output. The value represents the value expected parasitic losses at the design point. SAM uses the factor to calculate the power cycle's nameplate capacity for capacity-related calculations, including the estimated total cost per net capacity value on the [System Costs](#) page, and the capacity factor reported in the results.

**Estimated net output at design (nameplate), MWe**

The power cycle nominal electrical output.

$$\text{Estimated Net Output at Design (MWe)} = \text{Design Gross Output (MWe)} \times \text{Estimated Gross-to-net Conversion Factor}$$

**Cycle thermal efficiency**

The thermal-to-electric conversion efficiency of the power cycle at the design point. Note that this a nominal value: SAM calculates the power cycle's actual efficiency during the simulation and reports the actual value each time step in the [results](#). This value together with the turbine gross output determines the cycle nominal thermal power.

**Cycle thermal power, MWt**

The thermal power required at the power cycle inlet for it to operate at its design point.

$$\text{Cycle Thermal Power (MWt)} = \text{Design Turbine Gross Output (MWe)} \div \text{Cycle Thermal Efficiency}$$

## 19.3 Heliostat Field

The Heliostat Field page displays the variables that specify the position of the heliostats in the solar field along with the heliostat geometry and optical properties. Unlike parabolic trough and dish system designs, which can be based on modular designs of individual components, power tower system designs typically require optimization of the tower height, receiver geometry, and distribution of heliostats around the receiver as a complete system.

Page numbers relevant to this section from references cited with download links under "Power Tower" on the [CSP Publications](#) page of the SAM website:

- Wagner (2008) p 10, 23-42, 49
- SolarPILOT documentation (forthcoming): Layout Setup, Heliostats
- Kistler (1986) p 25-37, 39-47, 74-75

## Heliostat Field

The heliostat field inputs determine the position of heliostats in the field and define settings for the [SolarPILOT optimization algorithm](#). You can use SolarPILOT to automatically calculate heliostat positions and optimal values for the tower height, receiver height, and receiver aspect ratio (height / diameter). SolarPILOT considers the system's projected cost of energy by running a simulation for several time steps that represent a range of weather conditions using data from the weather file specified on the [Location and Resource](#) page and costs from the [System Costs](#) page. The optimization algorithm modifies the receiver dimensions, tower height, and field layout to based on the optimization settings to find the values that minimize the system's cost of energy. The optimization objective is penalized in the cases where either the maximum flux on the receiver exceeds the specified limit, or when the power delivered from the receiver after estimated surface and piping losses does not meet the design-point value.

The heliostat layout table lists the x-y coordinates of each heliostat in the field, where the point (0,0) is the position of the tower. You can either [import heliostat position data](#) from a text file, paste it from your computer's clipboard, or [use SolarPILOT](#) to calculate heliostat position coordinates and optimize the field geometry automatically.

You can also export the x-y coordinates from the table to a text file, or paste them to your computer's clipboard.

The two-dimensional map of the heliostat field shows the position of each heliostat in the table. The vertical axis is north-south, and the horizontal axis is east-west. Each row in the table represents a single heliostat position.

### **Heliostats**

The total number of individual heliostats in the field, equal to the number of rows in the heliostat layout table. SAM automatically populates the field when you import heliostat position data from a file or use SolarPILOT to generate the layout automatically.

### **Generate heliostat layout using tower dimensions / Calculate**

Run SolarPILOT to generate values for the table of heliostat x-y positions appropriate for the receiver height, receiver diameter, and tower height values that you specify on the Tower and Receiver input page. SAM replaces the data in the heliostat field table with the values calculated by SolarPILOT.

### **Optimize heliostat layout and tower dimensions / Calculate**

Run SolarPILOT to both generate values of heliostat x-y positions in the heliostat layout table and optimize tower height, receiver height, and receiver aspect ratio (height/diameter) using the inputs that you specify under **Optimization Settings**. When you click the **Calculate** button, SAM prompts you after the optimization to either overwrite inputs so you can either accept or reject the optimization results.

**Notes.**

Check **Generate heliostat layout using tower dimensions** to generate a new heliostat layout without changing the tower and receiver dimensions when you run a simulation. Click **Calculate** to generate the layout now.

Check **Optimize heliostat layout and tower dimensions** to both generate a new heliostat layout and optimize the tower and receiver dimensions. Click **Calculate** to generate the layout and dimensions now.

The optimal receiver design depends on the maximum receiver flux value on the [Tower and Receiver](#) page. The optimization algorithm seeks to minimize cost of energy given the maximum receiver flux. If the flux at the reference point exceeds the maximum value, the optimization algorithm considers increasing the receiver surface area to avoid exceeding the maximum flux in spite of the higher cost. See [SolarPILOT Field Layout and Optimization](#) for details.

If you are running a [parametric analysis](#) you can check the Optimize button to ensure that the heliostat layout and tower dimensions are optimized for each parametric scenario.

**Optimization Settings**

The optimization settings allow you to control aspects of the SolarPILOT optimization algorithm. The local derivative free (DFO) algorithm used in SAM is implemented in the [NLOpt package](#), provided for free online by MIT. This open-source code is implemented in C++, and can be readily incorporated into existing simulation frameworks such as SAM. A number of algorithms are provided in the NLOpt package, and gradient-based, global, and local derivative-free algorithms are all represented. Because this application is particularly interested in DFO without specified upper or lower bounds on variables and with a maximum flux constraint, only a one algorithm is used. The Bounded Optimization BY Quadratic Approximation (BOBYQA) routine optimizes the objective by iteratively constructing an objective function model based on a quadratic surface approximation (M. Powell, 2009). The stopping criteria for this algorithm was modified for the NLOpt library. As described in the reference, most iterative changes to the variable set represent a solution to the quadratic problem within the current trust region, which can change from iteration to iteration. This algorithm (along with its predecessor NEWUOA) is somewhat unique among the NLOpt library in its application of a quadratic response surface model.

**Initial optimization step size**

The normalized step size used by SAM's optimization algorithms to take the first step away from the initial design point. The step size represents the total fractional departure in any and all optimization variables.

For example, if the initial design to be optimized includes a tower height  $h_{tower} = 200m$ , receiver height of  $h_{rec} = 20m$ , and receiver aspect ratio  $\alpha = 1.0$ , all variables are first normalized by their initial value:

$$\bar{h}_{tower,0} = 1$$

$$\bar{h}_{rec,0} = 1$$

$$\bar{\alpha}_0 = 1$$

Next, the optimization algorithm chooses a search “direction” and takes a step by manipulating the normalized variable values. The step taken must fall within the initial optimization step size. Assuming a step size of 0.02, one such step may result in the values:

$$\bar{h}_{tower} = 0.99$$

$$\bar{h}_{rec} = 1.017$$

$$\bar{\alpha} = 1.003$$

Examining the step distances, we see that:

$$\sqrt{(\bar{h}_{tower} - \bar{h}_{tower,0})^2 + (\bar{h}_{rec} - \bar{h}_{rec,0})^2 + (\bar{\alpha} - \bar{\alpha}_0)^2} = 0.02$$

### Maximum optimization iterations

The maximum number of iterations (field layouts) allowed during optimization. The algorithm may satisfy convergence criteria before reaching the iteration limit and terminate. If the algorithm reaches the maximum number of iterations without converging, SAM will use the layout with the best objective function observed during iteration.

### Optimization convergence tolerance

The normalized tolerance that determines whether the algorithm has converged. Convergence may be obtained by the algorithm taking a normalized step size that is less in magnitude than the tolerance, or by the objective function (normalized) value ceasing to change by at least the tolerance value from iteration to iteration.

Increasing the tolerance value will generally result in fewer optimization steps taken, but may lead to lesser improvement in the objective function before convergence.

Note that the algorithms have different procedures for algorithm termination, and the tolerance value is usually one of several criteria. For more detailed information on algorithm behavior, refer to the [NLOpt documentation](#).

## Heliostat Properties

The heliostat properties define the area of a single heliostat mirrored surface, focusing and canting properties, and the optical error characteristics of the heliostat. Note that SAM assumes that each heliostat employs a two-axis drive system with a pivot at the center of the mirrored surface. Heliostats are also assumed to be rectangular in shape. Individual facets are modeled to be adjacent with no gaps in between.

### Heliostat Width, m

The width of the heliostat surface in meters, including the mirrored surface, edge supports and any cutouts.

### Heliostat Height, m

The height of the heliostat surface in meters, including the mirrored surface, edge supports and any cutouts or slots.

### Ratio of Reflective Area to Profile

The fraction of the area defined by the heliostat width and height that actually reflects sunlight. This value determines the ratio of reflective area on each heliostat to the total projected area of the heliostat

on a plane normal to the heliostat surface. The ratio accounts for non-reflective area on the heliostat that may cause shading of neighboring heliostats.

### Single Heliostat Area, m<sup>2</sup>

The area of the heliostat mirrored area, equal to the product of the heliostat width and height and the ratio of reflective area to heliostat profile.

### Mirror Reflectance and Soiling

The mirror reflectance input is the solar weighted specular reflectance. The solar-weighted specular reflectance is the fraction of incident solar radiation reflected into a given solid angle about the specular reflection direction. The appropriate choice for the solid angle is that subtended by the receiver as viewed from the point on the mirror surface from which the ray is being reflected. For parabolic troughs, typical values for solar mirrors are 0.923 (4-mm glass), 0.945 (1-mm or laminated glass), 0.906 (silvered polymer), 0.836 (enhanced anodized aluminum), and 0.957 (silvered front surface).

### Heliostat Availability

An adjustment factor that accounts for reduction in energy output due to downtime of some heliostats in the field for maintenance and repair. A value of 1 means that each heliostat in the field operates whenever sufficient solar energy is available. SAM multiplies the solar field output for each hour by the availability factor.

### Image Error, mrad

A measure of the deviation of the actual heliostat image on the receiver from the expected or ideal image that helps determine the overall shape and distribution of the reflected solar flux on the receiver. This value specifies the total conical error distribution for each heliostat at one standard deviation in radians. The Image Error term describes the “slope” error of the reflector surface, or equivalently the error distribution in which a normal vector to the heliostat may lie. The error term lies along a single axis in heliostat coordinates. SAM assumes that the orthogonal axis shares the same image error.

SAM applies the value to each heliostat in the field regardless of its distance from the tower. The image error accounts for all error sources, including tracking imprecision, foundation motion, mirror waviness, panel alignment problems, atmospheric refraction and tower sway.

### Reflected image conical error, mrad

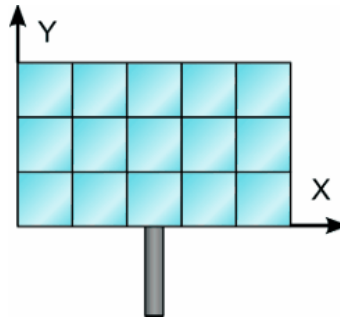
The equivalent conical error distribution about the reflected image vector, given the Image Error input. The total conical error is calculated as the root sum square of twice each individual-axis error component, though SAM assumes both error terms are equal.

$$\sigma_{c,tot} = \sqrt{2 \cdot (2\sigma_{1ax})^2}$$

Here,  $\sigma_{c,tot}$  is the reflected image conical error (mrad), and  $\sigma_{1ax}$  is the Image Error (slope, single axis) input.

### Number of heliostat facets – X

The number of heliostat facets (also known as “canting” panels) in the X direction. As shown in the following diagram, there are 5 facets in the X direction.

**Number of heliostat facets –Y**

The number of heliostat facets (also known as “canting” panels) in the Y direction. As shown in the diagram above, there are 3 facets in the Y direction.

**Heliostat focusing method**

The method used to determine the focal point for the heliostat (facet) surface(s). If multiple facets are used, the method applies to each facet individually.

**Ideal**

Each heliostat is focused using a parabolic shape where the focal length is equal to the distance between the heliostat centroid and the receiver image plane. The vector defining the focal point is collinear with the normal vector from the surface of the heliostat.

**Flat**

The heliostat is not focused and assumed to be planar. Flat heliostats facets may still be canted into a semi-focused shape.

**Heliostat canting method**

The method used to determine the focal point for the facets (if multiple facets are used). The focal point of the facets may differ from the focal point of the mirror surfaces. Canting is achieved by mounting individual mirror facets such that their normal vector differs from the heliostat aiming vector.

Individual facets may be canted and either flat or focused. Canting of flat facets achieves some degree of focusing, and performance of canted heliostats is maximized when sun position matches most closely that at which the panels were canted. As sun position deviates from the canting design point, additional optical aberration occurs and may degrade heliostat performance.

The canting process involves first choosing the heliostat aim point (determining the heliostat aiming vector) then modifying the aiming vector of each individual facet to achieve the best possible concentration ratio on the receiver given the heliostat's aiming position.

Facet aiming vectors may differ from the heliostat aiming vector after canting because of the displacement of each facet away from the centroid of the receiver (the origin of the receiver aiming vector).

**None**

Heliostats are not canted and all facets are mounted such that their surface normal vector as the same directionality as the heliostat aiming vector.

**On-axis**

Heliostats facets are mounted such that their normal vector intercepts the receiver focal point while the heliostat aiming vector also points to the receiver focal point. The heliostat facets are perfectly focused in the case where the sun position lies along the extrapolated heliostat aiming vector (in other words, when the heliostat is directly in the receiver shadow!).

**Equinox**

Heliostat facets are mounted such that their reflected image strikes the receiver aim point when the sun is at its equinox position (noon on March 20th or September 20th).

**Summer solstice**

Heliostat facets are mounted such that their reflected image strikes the receiver aim point when the sun is at its summer solstice position (noon on June 21st).

**Winter solstice**

Heliostat facets are mounted such that their reflected image strikes the receiver aim point when the sun is at its winter solstice position (noon on December 21st).

## Heliostat Operation

**Heliostat Stow Deploy Angle, degrees**

Solar elevation angle below which the heliostat field will not operate.

**Wind Stow Speed, m/s**

Wind velocity from the weather file at which the heliostats defocus and go into stowed position. At wind speeds above the stow speed, SAM assumes that the heliostats move into stow position to protect the mirror surface and support structure from wind damage. SAM accounts for the parasitic tracking power required to stow the heliostats, and to reposition them when the wind speed falls below the stow speed.

**Heliostat startup energy, kWe-hr**

The energy required to bring a single heliostat out of stow position to begin operation. Heliostat startup energy is applied during time steps when the field first operates after inactivity.

**Heliostat tracking energy, kWe**

The power required to operate a single heliostat. The tracking energy is applied during each time step in which a heliostat provides power to the receiver.

**Design-point DNI, W/m<sup>2</sup>**

The direct normal irradiation (beam normal) available at the reference design point. The power delivered to the receiver by the field when SAM determines the solar field layout depends on the Design-point DNI value that you specify.

Increasing this value indicates that fewer heliostats are needed to achieve the reference condition power, while decreasing this value has the opposite effect. The design-point DNI value should represent the DNI at which your plant should achieve the specified thermal rating, including thermal and piping losses

The Design-point DNI value is applied at the summer solstice noon sun position.

## Atmospheric Attenuation

Atmospheric attenuation is the optical loss applied to each heliostat due to scattering and distortion of light as it travels the distance between the heliostat and receiver. Attenuation loss depends strongly on the site air content and weather conditions, and attenuation increases as the distance between the heliostat and receiver increases.

You can define attenuation loss using a polynomial equation that calculates the fraction of loss as a function of the distance that the reflected light travels (also known as slant range).

The polynomial equation takes the following form, assuming polynomial coefficients  $c_0 \dots c_3$ :

$$\eta_{\text{att}}(s) = \sum_{i=0 \dots 3} c_i s^i$$

Where:

$$s = \sqrt{h_x^2 + h_y^2 + h_{\text{tower}}^2} \cdot \frac{1 \text{ km}}{1000 \text{ m}}$$

The heliostat x-y position  $(h_x, h_y)$  and the tower height  $h_{\text{tower}}$  determine the slant range  $s$  in kilometers.

### Polynomial coefficient 0

The constant term  $c_0$  in the atmospheric attenuation polynomial equation.

### Polynomial coefficient 1

The linear term  $c_1$  in the atmospheric attenuation polynomial equation.

### Polynomial coefficient 2

The quadratic term  $c_2$  in the atmospheric attenuation polynomial equation.

### Polynomial coefficient 3

The cubic term  $c_3$  in the atmospheric attenuation polynomial equation.

### Average attenuation loss, %

SAM calculates the average attenuation loss for the current field layout. This calculated value is the average attenuation loss evaluated according to the attenuation loss polynomial over all heliostat positions specified in the layout table.

## Solar Field Layout Constraints

### Max Heliostat Distance to Tower Height Ratio and Min Heliostat Distance to Tower Height Ratio

The maximum and minimum ratio of the distance from the heliostat furthest and closest from the tower to the tower height.

### Tower Height, m

The height of the tower in meters, from the heliostat pivot points to the vertical center of the receiver panels. Specify this value on the [Tower and Receiver](#) page. Note that the tower height value may be automatically populated by the [SolarPILOT](#) optimization algorithm.

### Max Distance to Tower and Min Distance from Tower, m

The maximum and minimum allowable radial distances in meters between the center of the tower base and heliostats furthest from the tower. Under certain conditions, SAM uses this value to calculate the radial step size. (See radial step size variable description below.)

## Importing Heliostat Position Data

The heliostat positions in the field are determined by the table of x-y coordinates for each heliostat in the field. You can either generate data for the table automatically using [SolarPILOT](#), or import the data from a



text file. This section explains how to import the data from a text file.

**Note.** You can also paste data into the table from your computer's clipboard as rows of tab-delimited values.

## Using the Layout Table with External Data

SAM can model a wide variety of heliostat field layouts originating from any kind of layout method. You can model field layouts generated outside of SAM by importing the heliostat positions into the table on the Heliostat Field page. You can either import a text file of x-y heliostat coordinates or copy and paste the data into the table from a spreadsheet program or text editor.

After you import the data, you can use the diagram of the field to verify that it imported correctly.

### Notes.

If you use your own field position data, you should make sure that the tower height, receiver height, receiver diameter, and other input values are appropriate for your field layout.

If you click **Generate heliostat layout** or **Optimize solar field geometry** after importing heliostat position data, *SAM will overwrite your data* with values calculated by SolarPILOT. It will also overwrite the table as part of the simulation if you check **Always layout automatically** or **Always optimize**.

Each row specifies the position of an individual heliostat relative to the tower. The first column in the table specifies the x-coordinate along the east-west axis of the field, with negative values indicating positions west of the tower, and positive values indicating positions east of the tower. The second column specifies the y-coordinate along the north-south axis, with positive values indicating positions north of the tower, and negative values indicating positions south of the tower. The tower is assumed to be at 0,0. Note that this convention also applies to systems in the southern hemisphere. SAM allows input of any field layout with no restrictions on heliostat positioning, field symmetry, etc. Use negative values for positions west and south of the tower. The heliostat coordinates do not have to be in a particular order in the file. Each column in the file should be separated by a tab or comma, and each row by a new line. A file with the following contents would describe a solar field with three heliostats at (x = 0.0, y = 75.0), (x = 7.5, y = 70.0), and (x = 15.0, y = 65.0):

```
0.0 75.0
7.5 70.0
15.0 65.0
```

## Land Area

SAM uses the land area to calculate land-related costs on the [System Costs](#) page when you specify costs in \$/acre.

### Non-solar field land area, acres

The land area occupied by the system, not including the heliostat field and tower.

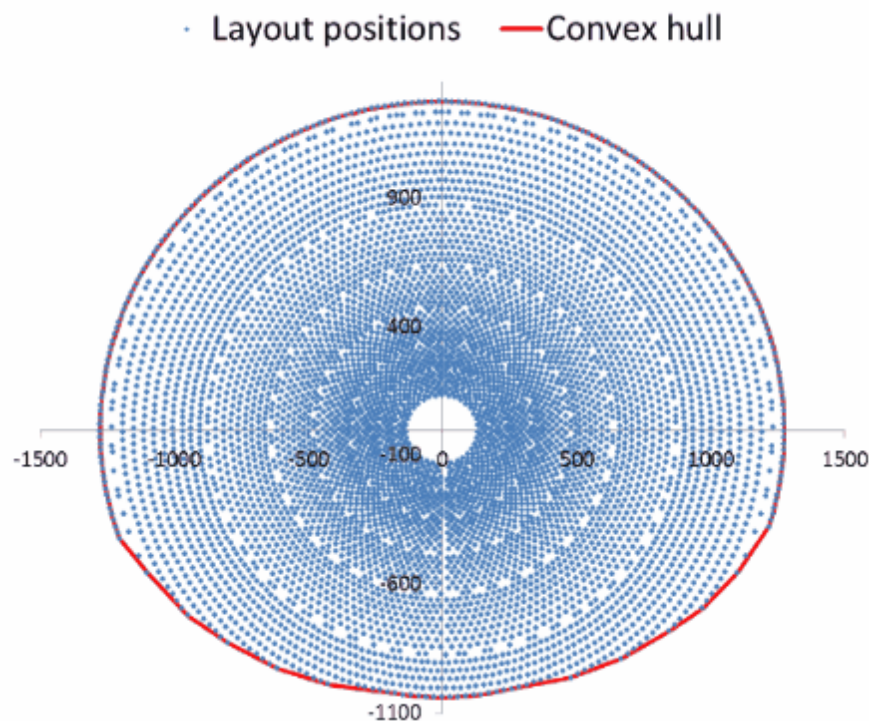
### Solar field land area multiplier

The ratio of the land area occupied by the solar field to the base land area. Use this multiplier to account for any land required for the solar field in excess of the convex hull defined by the base land area.

### Base land area, acres

The land area contained within a convex polygon that tightly bounds the heliostat field. The base land area includes any region contained within the heliostat field boundary, including the base of the tower.

SAM calculates the base land area by constructing a “convex hull” around the heliostat field layout and calculating the total area of that shape. The following figure illustrates a heliostat field layout and the convex hull shape determined by SAM. The convex hull is a polygon with vertices overlapping the set of most distant heliostat positions at any given azimuthal angle.



### Total land area, acres

The land area required for the entire system, including the heliostat field, tower, power plant, piping, storage tanks, buildings, etc.

$$\text{Total Land Area (acres)} = \text{Non-Solar Field Area (acres)} + \text{Base Land Area (acres)} \times \text{Solar Field Land Area Multiplier}$$

The total land area appears on the [System Costs](#) page, where you can specify land costs in dollars per acre.

### Total heliostat reflective area, m<sup>2</sup>

Total mirrored area of the heliostat field, equal to the heliostat reflective area multiplied by the number of heliostats. SAM uses the total reflective area to calculate the site improvements and heliostat costs expressed in dollars per square meter on the [System Costs](#) page.

## Heliosatat Field Availability

### Edit losses

The [Edit Losses](#) window allows you to specify constant, hourly, or hourly block schedules to alter the solar field output over time. The loss affects the solar field optical efficiency by increasing or decreasing the efficiency proportionally based on the value(s) that you specify for availability. This input may be useful in characterizing heliostat downtime, washing schedules, or other effects where field production may not match the ideal calculation.

### Mirror Reflectance and Soiling

The mirror reflectance input is the solar weighted specular reflectance. The solar-weighted specular reflectance is the fraction of incident solar radiation reflected into a given solid angle about the specular reflection direction. The appropriate choice for the solid angle is that subtended by the receiver as viewed from the point on the mirror surface from which the ray is being reflected. For parabolic troughs, typical values for solar mirrors are 0.923 (4-mm glass), 0.945 (1-mm or laminated glass), 0.906 (silvered polymer), 0.836 (enhanced anodized aluminum), and 0.957 (silvered front surface).

### Heliostat Availability

An adjustment factor that accounts for reduction in energy output due to downtime of some heliostats in the field for maintenance and repair. A value of 1 means that each heliostat in the field operates whenever sufficient solar energy is available. SAM multiplies the solar field output for each hour by the availability factor.

## SolarPILOT Field Layout and Geometry Optimization

SolarPILOT™ simplifies the task of choosing values for the relatively large number of input parameters required to specify the power tower solar field and receiver. Because the heliostat field is typically the most capital intensive part of a power tower project, often accounting for 30-40% of the total installation cost, optimizing the heliostat field size is a critical step in minimizing overall project cost.

The SolarPILOT optimization algorithm searches for a set of optimal system design values, where the optimal system is defined as the one that results in the lowest levelized cost of energy. Note that the optimization process is separate from the simulation process. When you run SolarPILOT, it populates some of the input variables in the SAM input pages (listed below) with optimal values. Before running simulations, you can choose to either keep the values generated by the algorithm or modify them.

SolarPILOT was developed by NREL and generates field layouts and characterizes optical performance of the solar field using an analytical technique derived from the Hermite polynomial approach used in DELSOL3 and elsewhere (Dellin, 1979; Kistler, 1986; Lipps & Vant-Hull, 1978; Walzel, Lipps, & Vant-Hull, 1977). More information on SolarPILOT is available in the SolarPILOT technical documentation.

The DELSOL3 code from Sandia National Laboratories is available at [http://energy.sandia.gov/?page\\_id=6530](http://energy.sandia.gov/?page_id=6530), and was implemented in SAM 2014.1.14 and older versions through the PTGen program described in the thesis *Simulation and Predictive Performance Modeling of Utility-Scale Central Receiver System Power Plants* (Wagner 2008) ([PDF 33 MB](#)).

### **To use SolarPILOT for optimization:**

1. On the [System Costs](#) page, enter values for the capital costs.
2. On the [Heliostat Field](#), [Power Cycle](#), and [Tower and Receiver](#) pages, enter values defining geometry and optical parameters.  
The optimization algorithm works by exploring the design near the initial guess values, so be sure to enter your best guess for tower height, receiver diameter, and receiver height based on the system you are simulating.

3. On the Heliostat Field page, enter values to define the parameters of the optimization.
4. On the Heliostat Field page, click **Optimize Solar Field Geometry**.  
As the optimization progresses, SAM displays a table showing the tower height (THT), receiver height to diameter ratio (Aspect), receiver height (RecHeight), along with the objective function (Obj) and peak flux intensity on the receiver (Flux).  
The objective function value is a surrogate for cost of energy, but includes penalties for flux exceeding the maximum allowable value or power falling below the target design-point value. The objective function value is not the same as the levelized cost of energy, and is only useful in the context of the optimization.
5. After SolarPILOT finishes the optimization, SAM displays the the optimization results in the Optimization Summary table.  
To replace the inputs for receiver height, receiver diameter, tower height, and heliostat layout in SAM with the optimal values in the table, click **Yes**. To discard the optimization results without changing the SAM inputs, click **No**.
6. Review the variables on the input pages. Modify any values as needed, and then configure and run simulations to simulate the system(s) and display annual production, levelized cost of energy, and other results on the [Results](#) page.

## Overview of the SolarPILOT Optimization Algorithm

Optimizing the solar field reduces the system's cost of energy by exploring the design space around the initial guess values for tower height, receiver height, and receiver aspect ratio. SolarPILOT uses the optimization algorithm that you specify on the Heliostat Field page to manipulate the design. The algorithm is constructed to seek the minimum cost of energy for the system subject to maximum flux and minimum power constraints. Each step in the optimization process consists of a full layout and performance simulation performed by SolarPILOT. Optimization accounts for the weather data in the file that you select, capital costs, optical performance, and approximate thermal performance.

The optimization algorithm uses the solar multiple and the estimated receiver and piping thermal losses to calculate the receiver's thermal rating, which is calculated as follows:

$$\dot{q}_{des} = \rho \dot{q}_{inc} - \dot{q}_{hl}'' A_{rec} - \dot{q}_{pipe}$$

Here,  $\dot{q}_{des}$  is the receiver design-point thermal power output that is displayed as Receiver Design Thermal Power (MWt) on the Tower and Receiver page,  $\rho$  is the Coating Absorptance value from the Tower and Receiver page,  $\dot{q}_{hl}''$  is the Estimated Receiver Heat Loss (kWt/m<sup>2</sup>) value from the Tower and Receiver page,  $A_{rec}$  is the calculated Receiver Area value displayed on the System Costs page, and  $\dot{q}_{pipe}$  is the Total Piping Loss (converted to MWt) displayed on the Parasitics page.

The algorithm holds the following variables constant as it searches for the optimal system:

- Solar Multiple on the Tower and Receiver page.
- Nameplate Capacity on the Power Cycle page.
- Heliostat Width on the Heliostat Field page.
- Heliostat Height on the Heliostat Field page.
- Maximum Receiver Flux (boiler, superheater, and reheater fluxes for the direct steam tower model) on the Tower and Receiver page.

The algorithm searches to find optimal values of the following variables on the Tower and Receiver page. When SolarPILOT finishes running, SAM optionally populates the variables with the optimal values.

- Receiver Diameter
- Receiver Height (calculated as a function of the receiver height to the receiver diameter ratio)
- For the direct steam tower model, boiler, superheater, and reheater height. The sum of these three heights is the receiver height.
- Tower Height

SAM also populates the following variables on the Heliostat Field page with values from SolarPILOT:

- Field layout table
- Total Reflective Area
- Number of Heliostats

The optimization algorithm uses the following values from the input pages, but does not change their values.

From the Heliostat Field page:

- Heliostat Width
- Heliostat Height
- Ratio of Reflective Area to Profile
- Mirror Reflectivity and Soiling
- Max Distance from Tower
- Min Distance from tower
- Image Error

For the molten salt tower model, from the Tower and Receiver page:

- Coating Absorptivity
- Max Receiver Flux
- Estimated receiver heat loss
- Receiver flux map resolution

For the direct steam tower model, from the Tower and Receiver page:

- Coating Absorptivity
- Max Boiler Flux
- Max Superheater Flux
- Superheater Outlet Temperature Set Point
- Reference Superheater Efficiency
- Max Reheater Flux
- Reheater Outlet Temperature Set Point
- Reference Reheater Efficiency
- Estimated receiver heat loss
- Receiver flux map resolution

From the Power Cycle page:

- Nameplate Capacity
- Rated Cycle Conversion Efficiency

Since the optimization algorithm uses derivative-free nonlinear algorithms, it is impossible to guarantee that the solution identified by SAM is optimal. The success of the optimization algorithm depends on the initial guess values (the values entered for receiver height, diameter, and tower height) when the optimization

process begins and on the optimization settings on the Heliostat Field page. It is possible that the algorithm will converge to a solution that is not optimal, or to a solution that does not satisfy the flux or power requirements that you specify.

Finding an optimal set of input parameters is often an iterative process that may require you to run the optimization algorithm and adjust guess values or settings several times until the algorithm finds a reasonable field layout for your analysis. You may find more consistent success by successively reducing the Initial Optimization Step Size, decreasing the Optimization Convergence Tolerance, or starting the simulation using randomized starting values for the receiver height, diameter, and tower height.

Keep in mind that because the algorithm uses capital costs from the Tower System Costs page in the optimization process, unreasonable cost values may also prevent the algorithm from finding an optimal field layout.

## Guidelines for Choosing Variable Ranges for Optimization

The optimization algorithm does its best to find parameter values for an optimal system within the search ranges you specify on the SolarPILOT input tabs. Because the algorithm searches a discrete number of values within the range for each parameter, defining too broad of a range increases the chances that the optimal value lies between the values included in the search. On the other hand, defining too narrow a range increases the chances that the optimal value lies outside of the search range.

The ability of the optimization algorithm to find an optimal system is sensitive to the following variable ranges:

- Receiver diameter range, defined by Minimum Receiver Diameter and Maximum Receiver Diameter.
- Receiver height to diameter ratio range, defined by Minimum Receiver Height/Diameter Ratio and Maximum Receiver Height/Diameter Ratio.
- Tower height range, defined by Minimum Tower Height and Maximum Tower Height.
- Heliostat distance from tower range, defined by Maximum Distance from Tower and Minimum Distance from Tower values on the Heliostat Field page.

The following rules of thumb may be helpful in choosing search ranges for these variables, although they may not apply to some systems.

- Tower height: The tower height typically falls between 15 m for very small systems (5 MWe) and 300 m for very large systems (150 MWe). For example, a reasonable range for a 30 MWe system with a solar multiple of 1.0 would be between 40 m and 120 m.
- Receiver diameter: The optimization algorithm searches for a receiver diameter value that maximizes absorbed radiation from the heliostat field within the flux limit defined by the maximum value on the Receiver/Tower page. Like the tower height, the receiver area typically scales with system's design thermal power. For very small systems, the optimal receiver diameter is typically between 1 m and 3 m, while very large systems may require a diameter of 25 m.
- Receiver height to diameter ratio: This ratio should generally fall between 0.5 and 2.0.
- Heliostat distance from tower: If the minimum distance is too small, the inner zones in the heliostat will contain no heliostats (the first rows in the field layout table on the Heliostat Field page contain zeros), which will cause the simulation to fail. If the maximum distance is too large, the outer zones will contain no heliostats. On the other hand, if the maximum distance is too small, all of the outer zones will contain heliostats. For very small systems, the maximum distance might be set to 300 m, and for very large systems, a distance of 2000 m might be appropriate.

## 19.4 Heliostat Field Layout

The heliostat field layout is managed by NREL's SolarPILOT™ software. SolarPILOT replaces DELSOL3 in SAM 2014.1.14 and older versions. SolarPILOT evaluates the heliostat field layout by characterizing each potential heliostat position individually. This approach replaces DELSOL3's zonal simplification. This approach allows much greater flexibility in the types of heliostat field layouts that SAM can model, although improved flexibility comes with a greater computational burden for optical characterization.

SolarPILOT is [available as stand-alone software](#), and is integrated with SAM using its application programming interface (API) SAM.

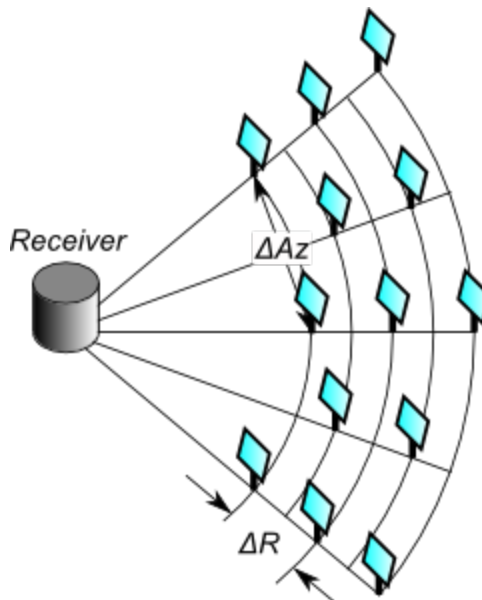
SAM offers two options for designing the heliostat field:

- You can design the field outside of SAM and import the layout as a table of heliostat positions with Cartesian x and y coordinates with respect to the tower at position (0,0).
- You can use SAM to run SolarPILOT and automatically generate heliostat positions given a tower height, heliostat geometry and optical properties, and receiver geometry and optical properties.

SAM uses the following process to choose which heliostat positions will be included in the final layout:

1. **Collect user-specified information** on receiver geometry, heliostat geometry, system optical properties, tower height, plant location and weather data, atmospheric conditions, and field layout constraints. Choose each input in this group carefully, as the layout algorithm incorporates all of this information in identifying the most productive heliostat positions.
2. **Generate a set of potential heliostat positions** using the "radial stagger" layout method. All positions within the minimum and maximum land bounds are initially included in the list of potential heliostats.

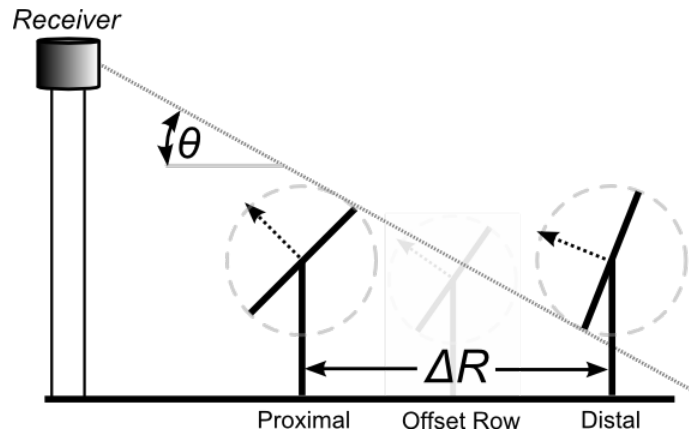
The radial stagger layout method places heliostats in rows of constant radius (iso-radial lines) where the center of the tower base is the center point and along lines of constant azimuth angle (azimuthal lines):



The initial spacing between heliostats in a row is a distance twice the width of a heliostat. As the radial position of the rows increases, so too does the spacing between heliostats as they maintain their position along an azimuthal line. Spacing continues to increase until the distance between

heliostats meets or exceeds  $2 \frac{2}{3}$  times the heliostat width. Spacing then resets to the original factor of 2 times the width.

The radial spacing between rows depends on the distance of each row from the tower. Row positions are determined to ensure that heliostats that lie directly behind a closer row (every other row in the layout) has sufficient space to eliminate blocking of reflected light:



3. **Evaluate the available heliostat positions** from step (2) to determine estimated annual performance for each heliostat. A set of approximately 25 time steps are simulated throughout the year using averaged weather profiles for each simulation. The time steps compose 4 daily profiles with simulations every other hour. Each hour in the time step contains averaged weather data for the quarter of the year surrounding that day at the same hour of the day. In this way, SAM predicts the amount of power delivered by each heliostat position.

The simulations evaluate the optical efficiency of each heliostat and include cosine, attenuation, intercept factor, reflectance and soiling, and blocking effects.

Note that all heliostats are aimed at the centerpoint of the receiver during layout calculations. This approach is known as simple aim point strategy, where heliostats aim their reflection at the vertical centerline of the receiver in the region nearest the heliostat.

Note that shadowing is not considered during layout simulations for several reasons:

- Blocking and shadowing simulations result in similar efficiency trends over the year, so inclusion of blocking is typically sufficient to remove problematic heliostats.
  - The number of heliostats within range for shadowing from a given heliostat depends on the elevation angle of the sun, and low-elevation scenarios can result in comparison of a very large number of heliostats, significantly slowing down simulation speed.
  - The final layout is not significantly impacted by shadowing, given the blocking consideration mentioned above.
  - Inclusion of shadowing can lead to “cascaded” efficiency loss, where heliostats that would normally be omitted due to blocking shadow neighboring heliostats and cause subsequent removal of otherwise productive heliostats.
4. **Collect simulation** results for each heliostat and ranks each heliostat according to its simulated annual productivity.
  5. **Run a reference-point simulation** that determines the energy delivered by the solar field to the receiver at a reference condition. The reference condition is the summer solstice at solar noon.



6. **Remove the worst-performing heliostats** from the layout in order beginning with the poorest heliostat. Removal continues while the total power delivered to the receiver exceeds the design-point thermal power plus estimated thermal losses from the receiver surface and from runner piping. Once the delivered power falls below the design threshold, the resulting list of heliostats comprises the final field layout.

Heliostat layout generation assumes a constant receiver height and diameter and a constant tower height. SAM can optimize these variable values using the optimization tool. More information on solar field geometry optimization is provided in the Optimization section below.

## 19.5 Tower and Receiver

The Tower and Receiver page displays variables that specify the geometry of the heat collection system. The receiver model uses semi-empirical heat transfer and thermodynamic relationships to determine the thermal performance of the receiver. This allows the model to represent a wide array of geometries without deviating from a hypothetical reference system.

Page numbers relevant to this section from references cited with download links under "Power Tower" on the [CSP Publications](#) page of the SAM website:

- Wagner (2008) p 43-47, 68-71

The model makes several assumptions about the system geometry for external receivers:

- The receiver consists of a discrete number of panels.
- Each panel in the receiver consists of a set of parallel tubes in thermal contact that share a common heat transfer fluid (HTF) header.
- The panel tubing is vertical and the heat transfer fluid flows through each sequential panel in a serpentine pattern (up one panel and down the adjacent panel).
- The number of tubes per panel is a function of the Number of Panels, Receiver Diameter, and Tube Outer Diameter variables.

The model varies the heat transfer fluid mass flow rate through the receiver to maintain the required outlet heat transfer fluid temperature. The model includes several practical safeguards to ensure realistic behavior in the receiver. For example, the mass flow rate through the receiver is limited to the value of the Max Flow Rate to Receiver variable, and the maximum receiver heat transfer fluid inlet temperature is kept at a value below the value of the Max Temp to Receiver variable.

SAM allows several options for the heat transfer fluid flow patterns through the receiver as indicated by the diagrams on the Receiver / Tower page. The Flow Pattern variable specifies the path taken by the fluid as it passes through the receiver. Options include a full circle around the receiver, a split path around the receiver, and a split pass with a single cross-over.

### System Design Parameters

The system design parameters are variables that you specify on the [System Design](#) page. They are shown here for reference.

**Solar multiple**

The solar multiple determines the receiver's nominal thermal capacity. It is the ratio of the receiver design thermal output to the power cycle design thermal power input. For a system with no storage, the solar multiple should be close to or equal to one.

**Receiver thermal power, MWt**

The receiver's thermal power output at the design point.

$$\text{Receiver Thermal Power (MWt)} = \text{Solar Multiple} \times \text{Cycle Thermal Power (MWt)}$$

**HTF hot temperature, °C**

The temperature of the hot heat transfer fluid at the receiver outlet when the power cycle operates at its nameplate capacity under design conditions.

**HTF cold temperature, °C**

The temperature of the cold heat transfer fluid at the receiver inlet when the power cycle operates at its nameplate capacity under design conditions.

**Tower and Receiver Dimensions****Notes.**

The receiver parameters are for an external receiver.

When you run the SolarPILOT optimization from the [Heliostat Field](#) page, SAM overwrites the the tower height, receiver height, and receiver diameter values with optimal values calculated by SolarPILOT.

**Tower height, m**

Height in meters of the tower structure, equal to the vertical distance between the heliostat pivot points and the vertical center of receiver.

**Receiver height, m**

Height in meters of the receiver panels.

**Receiver diameter, m**

Total diameter in meters of the receiver. The distance from center of the receiver to center of a receiver panel. The width of a single panel is the circumference of receiver divided by number of panels.

**Number of panels**

Number of vertical panels in the receiver.

**Note.** For **Flow Pattern** options 1-4, **Number of Panels** must be a multiple of 2. If you specify an invalid number, the simulation will fail, and SAM will generate an error message.

**Receiver Heat Transfer Properties****Tube outer diameter, mm**

The outer diameter in millimeters of the tubing that carries the heat transfer fluid through the receiver panels. Typical values range from 25 mm to 50 mm.

**Tube wall thickness, mm**

The thickness in millimeters of the individual receiver panel tube walls.

**Coating emittance**

The emissivity of the receiver coating, assumed to be black-body emissivity constant over the range of wavelengths.

**Coating absorptance**

Absorptance fraction of receiver tube coating. Typical values are 0.91 to 0.95.

**Heat loss factor**

A receiver heat loss adjustment factor that can be used when the calculated heat loss value deviates from an expected value. The default value is 1, corresponding to no heat loss correction. The calculated receiver heat loss is the sum of convection and radiation losses from the receiver, reported in the hourly results as Rec\_conv\_loss and Rec\_rad\_loss, respectively.

**Design and Operation****Minimum receiver turndown fraction**

The minimum allowable fraction of the maximum flow rate to receiver.

**Maximum receiver operation fraction**

The maximum allowable fraction of the maximum flow rate to receiver. SAM removes heliostats from operation if the HTF mass flow rate exceeds the maximum allowable value.

**Receiver startup delay time**

The time in hours required to start the receiver. The receiver starts whenever the radiation incident on the field in the previous hour is zero, and there is sufficient thermal energy in the current hour to meet the thermal design requirement. SAM calculates the start up energy as the product of the available thermal energy, startup delay time, and startup delay energy fraction.

**Receiver startup delay energy fraction**

Fraction of receiver design thermal power required by the receiver during the startup period.

**Receive HTF pump efficiency**

The electro-mechanical efficiency of the receiver heat transfer fluid pump.

**Maximum flow rate to receiver, kg/s**

The maximum heat transfer fluid flow rate at the receiver inlet. SAM calculates this value as a function of the maximum heat transfer fluid velocity in the receiver.

$$\text{Maximum Flow Rate to Receiver} = \frac{\text{Maximum Receiver Operation Fraction} \times \text{Receiver Thermal Power (MWt)} \times 1,000,000}{\text{HTF Specific Heat} \times 1,000,000 \times (\text{HTF Hot Temperature } ^\circ\text{C} - \text{HTF Cold Temperature } ^\circ\text{C})}$$

**Materials and Flow****HTF type**

One of two types of solar salt used for the heat transfer fluid, also called the working fluid. You can also add a user defined HTF by choosing the user defined option and clicking the **Edit** button to open the HTF properties editor.

**Property table for user-defined HTF**

When the HTF type is "user defined," the Edit button provides access to the HTF properties editor.

**Material type**

The material of the receiver panel tubes, typically a stainless-steel alloy. The current version of SAM allows only one material type.

**Flow pattern**

One of eight available heat transfer fluid flow configurations shown in the diagram.

The view in the diagram is from the top of the receiver, assuming that panels are arranged in a circle around the center of the receiver. Arrows show the direction of heat transfer fluid flow into, through, and out of the receiver, with arrows pointing up indicating flow toward the north.

**Note.** For **Flow Pattern** options 1-4, **Number of Panels** must be a multiple of 2. If you specify an invalid number, the simulation will fail, and SAM will generate an error message.

**Receiver Flux Modeling Parameters****Maximum receiver flux, kWt/m<sup>2</sup>**

The maximum allowable incident flux on the receiver, before reflection, re-radiation, or convection losses.

The maximum flux is used only during optimization when SAM manipulates the receiver geometry to satisfy the maximum flux constraint. Flux intensity is determined at the reference design condition (noon on the summer solstice) at the Design-point DNI value that you specify. The flux is checked along a grid of points on the receiver. The flux grid has 10 equally-spaced vertical points per panel.

**Estimated receiver heat loss, kWt/m<sup>2</sup>**

The estimated receiver heat loss at design-point operation per unit area of receiver surface.

This value is used to determine the amount of additional power required from the solar field to overcome receiver heat loss. In previous versions of SAM, this value was assumed to be 30 kWt/m<sup>2</sup>.

Note that this value is used only to determine the required solar field size and does not affect annual hourly performance simulation results once the layout has been specified.

**Receiver flux map resolution**

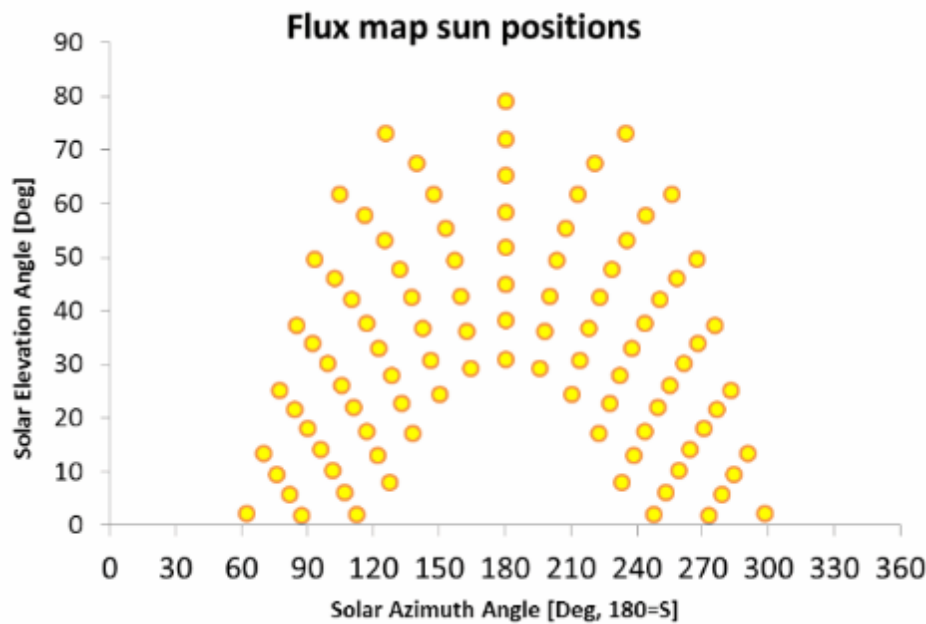
A calculated value indicating the number of flux points on the receiver considered during flux mapping. The number of flux points is equal to the number of panels on the receiver, but must be at least 12.

**Number of days in flux map lookup**

The number of days used to calculate the receiver flux map lookup table.

When calculating receiver flux maps, SAM uses the number of days that you specify but spaces them throughout the year according to the variation in sun position. SAM chooses the actual days to simulate by maintaining equal solar angle spacing among each day. The spacing between days is important in ensuring that the flux map lookup table is as comprehensive as possible.

The following plot shows flux map sun positions for 8 lookup table days and hourly simulations. Equal spacing is maintained between daily profiles.



### Hourly frequency in flux map lookup

The hourly frequency over the course of each flux map simulation day at which simulations are executed.

For example, the plot above (see No. Days in Flux Map Lookup) provides simulations on an hourly frequency. If you specify 2 as the hourly frequency, simulations will be executed every other hour; 3 will be executed every third hour, etc.

SAM always constructs the hourly simulations to ensure symmetry about solar noon. A simulation will always be performed at solar noon, and the hourly frequency determines the nearest times for simulation in the morning and afternoon hours. Increasing the hourly frequency value decreases the number of simulations included in the flux map lookup table and may increase interpolation error. Decreasing the frequency has the opposite effect.

## Piping Losses

### Piping heat loss coefficient, Wt/m

Thermal energy loss per meter length of piping between the tower and thermal storage system, including both hot (downcomer) and cold (riser) header piping. This loss does not include thermal losses from the receiver due to convection, emission, or reflection.

### Piping length constant, m

Fixed piping length used to calculate the total piping length for thermal losses.

### Piping length multiplier

Factor multiplying the tower height that is used to calculate the total piping length for thermal losses.

### Piping length, m

Calculated total piping length used to calculate the piping thermal losses.

$$\text{Piping Length (m)} = \text{Piping Length Multiplier} \times \text{Tower Height (m)} + \text{Piping Length Constant}$$

Note that this this piping length is used only in the calculation of thermal energy loss from the receiver and is not used for pressure loss or pumping parasitic power requirement calculations.

### Total piping loss, kWt

The calculated thermal energy loss due to header piping, applied whenever the receiver is operating.

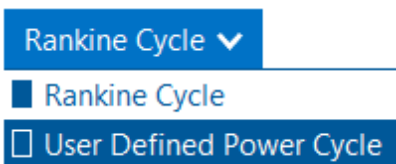
$$\text{Total Piping Loss (kWt)} = \text{Piping Length (m)} \times \text{Piping Heat Loss Coefficient (Wt/m)} \div 1000 \text{ (kW/W)}$$

## 19.6 Power Cycle

The power cycle converts thermal energy to electric energy. The power tower model offers two options for modeling the power cycle:

- The **Rankine-cycle** model is for Rankine-cycle steam engines with two open feed-water heaters, and a pre-heater, boiler and super-heater. This regression model was developed from a detailed first-principles basis Rankine cycle model and calculates cycle performance over the expected operating range by modeling each cycle component at off-design conditions. The model assumes that deviation in cycle performance at off-design conditions is independent of cycle design and only a function of deviation from the user-specified design point. This model is fast, flexible, and accurate, and suitable for modeling most conventional CSP power cycles.
- The **user-defined power cycle** model allows you to use data from your own power cycle model in SAM, and can be used to model Rankine or other types of power cycles. It requires that you provide values for general power cycle parameters along with a tables of data showing the electrical power generated over a range of HTF mass flow rates, ambient temperatures, and ambient temperatures. SAM uses this data to build a power cycle regression model that considers single variable effects and two variable interactions.

**Note** If you are modeling a supercritical Carbon dioxide (sCO<sub>2</sub>) cycle, you can use the **sCO<sub>2</sub> Cycle Integration** [macro](#) with the [NREL Supercritical Carbon Dioxide \(sCO<sub>2</sub>\) Python model](#).



### System Design Parameters

The system design parameters are from the [System Design](#) page, where you can define the design-point parameters of the entire power tower system.

#### Power cycle gross output, MWe

The power cycle electrical output at the design point, not accounting for parasitic losses.

#### Estimated gross to net conversion factor

An estimate of the ratio of the electric energy delivered to the grid to the power cycle's gross output to account for parasitic losses.

**Estimated net output (nameplate), MWe**

The power cycle nominal capacity, calculated as the product of the gross output and gross-to-net conversion factor.

$$\text{Estimated Net Output at Design (MWe)} = \text{Design Gross Output (MWe)} \times \text{Estimated Gross to Net Conversion Factor}$$

**Cycle thermal efficiency**

The thermal to electric conversion efficiency of the power cycle at the design point.

**Cycle thermal power, MWt**

The turbine thermal input at the power cycle inlet to operate at the design point.

**HTF hot temperature, °C**

The design temperature of the hot heat transfer fluid at the power cycle block inlet.

**HTF cold temperature, °C**

The design temperature the cold heat transfer fluid at the power cycle outlet.

**General Design Parameters****Pumping power for HTF through power block, kW/kg/s**

A coefficient used to calculate the electric power consumed by pumps to move heat transfer fluid through the power cycle.

**Fraction of thermal power needed for standby**

The fraction of the turbine's design thermal input required from storage to keep the power cycle in standby mode. This thermal energy is not converted into electric power. Default is 0.2.

**Power block startup time, hours**

The time in hours that the system consumes energy at the startup fraction before it begins producing electricity. If the startup fraction is zero, the system will operate at the design capacity over the startup time. Default is 0.5 hours.

**Fraction of thermal power needed for startup**

The fraction of the turbine's design thermal input required by the system during startup. This thermal energy is not converted to electric power. Default is 0.75.

**Minimum turbine operation**

The fraction of the nameplate electric capacity below which the power block does not generate electricity. Whenever the power block output is below the minimum load and thermal energy is available from the solar field, the field is defocused. For systems with storage, solar field energy is delivered to storage until storage is full. Default is 0.25.

**Maximum turbine over design operation**

The maximum allowable power block output as a fraction of the electric nameplate capacity. Whenever storage is not available and the solar resource exceeds the design value of 950 W/m<sup>2</sup>, some heliostats in the solar field are defocused to limit the power block output to the maximum load. Default is 1.05.

**Cycle design HTF mass flow rate, kg/s**

The hot heat transfer fluid (HTF) mass flow rate at the design point.

$$\text{HTF Mass Flow Rate (kg/s)} = \frac{\text{Cycle Thermal Power (MWt)} \times 1000 \text{ (kW/MW)} \div \text{Average HTF Cp (KJ/kg}\cdot\text{K)} \times (\text{HTF Hot Temperature (}^\circ\text{C)} - \text{HTF Cold Temperature (}^\circ\text{C)})$$

## Rankine Cycle Parameters

Page numbers relevant to this section from references cited with download links under "Power Tower" on the [CSP Publications](#) page of the SAM website:

- Wagner (2008) pp 83, 86, 114, 164
- Kistler (1986) p 224
- Hamilton (2020) p TBD

The power cycle page displays variables that specify the design operating conditions for the steam Rankine cycle used to convert thermal energy to electricity.

### **Boiler operating pressure, Bar**

The saturation pressure of the steam as it is converted from liquid to vapor in the boiler or steam generator. SAM uses this value to determine the steam's saturation temperature and thus the superheating capability of the heat exchangers. The temperature difference that drives the steam mass flow rate in the Rankine cycle is the difference between the hot heat transfer fluid inlet temperature and the saturation temperature of the steam boiler pressure.

### **Steam cycle blowdown fraction**

The fraction of the steam mass flow rate in the power cycle that is extracted and replaced by fresh water. This fraction is multiplied by the steam mass flow rate in the power cycle for each hour of plant operation to determine the total required quantity of power cycle makeup water. The blowdown fraction accounts for water use related directly to replacement of the steam working fluid. The default value of 0.013 for the wet-cooled case represents makeup due to blowdown quench and steam cycle makeup during operation and startup. A value of 0.016 is appropriate for dry-cooled systems to account for additional wet-surface air cooling for critical Rankine cycle components.

### **Turbine inlet pressure control**

Determines the power cycle working fluid pressure during off-design loading.

**Fixed Pressure:** The power block maintains the design high pressure of the power cycle working fluid during off-design loading.

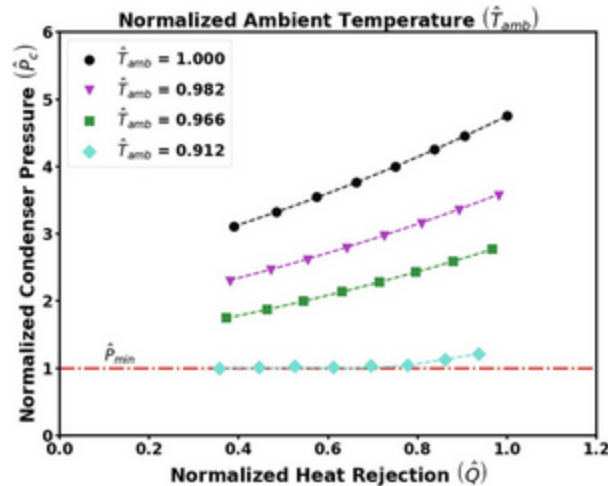
**Sliding Pressure:** The power block decreases the high pressure of the power cycle working fluid during off-design loading.

### **Condenser type**

Choose either an air-cooled condenser (dry cooling), evaporative cooling (wet cooling), or hybrid cooling system.

The air-cooled condenser model utilizes a second-order bi-variate polynomial in terms of normalized ambient temperature and normalized heat rejection to determine normalized condenser pressure as shown in the graph below. Ambient temperature (converted to Kelvin) and heat rejection are normalized by their design conditions, while condenser pressure is normalized by the minimum condenser pressure. This model is valid for normalized ambient temperatures greater than 0.9. For conditions lower than this threshold, the condenser pressure is set to its minimum value.





In hybrid cooling, a wet-cooling system and dry-cooling share the heat rejection load. Although there are many possible theoretical configurations of hybrid cooling systems, SAM only allows a parallel cooling option.

Specify the hybrid cooling dispatch fractions on the [System Control](#) input page.

#### Ambient temperature at design , °C

The ambient temperature at which the power cycle operates at its design-point-rated cycle conversion efficiency. For the air-cooled condenser option, use a dry bulb ambient temperature value. For the evaporative condenser, use the wet bulb temperature.

#### ITD at design point , °C

For the air-cooled type only. Initial temperature difference (ITD), difference between the temperature of steam at the turbine outlet (condenser inlet) and the ambient dry-bulb temperature.

**Note.** When you adjust the ITD, you are telling the model the conditions under which the system will achieve the thermal efficiency that you've specified. If you increase the ITD, you should also modify the thermal efficiency (and/or the design ambient temperature) to accurately describe the design-point behavior of the system. The off-design penalty in the modified system will follow once the parameters are corrected.

#### Reference condenser water dT, °C

For the evaporative condenser type only. The temperature rise of the cooling water across the condenser under design conditions, used to calculate the cooling water mass flow rate at design, and the steam condensing temperature.

#### Approach temperature, °C

For the evaporative type only. The temperature difference between the circulating water at the condenser inlet and the wet bulb ambient temperature, used with the ref. condenser water dT value to determine the condenser saturation temperature and thus the turbine back pressure.

#### Condenser Pressure Ratio

For the air-cooled type only. The pressure-drop ratio across the air-cooled condenser heat exchanger, used to calculate the pressure drop across the condenser and the corresponding parasitic power required to maintain the air flow rate.

### Minimum condenser pressure

The minimum condenser pressure in inches of mercury prevents the condenser pressure from dropping below the level you specify. In a physical system, allowing the pressure to drop below a certain point can result in physical damage to the system. For evaporative (wet cooling), the default value is 1.25 inches of mercury. For air-cooled (dry cooling), the default is 2 inches of mercury. For hybrid systems, you can use the dry-cooling value of 2 inches of mercury.

### Cooling system part load levels

The cooling system part load levels tells the heat rejection system model how many discrete operating points there are. A value of 2 means that the system can run at either 100% or 50% rejection. A value of three means rejection operating points of 100% 66% 33%. The part load levels determine how the heat rejection operates under part load conditions when the heat load is less than full load. The default value is 2, and recommended range is between 2 and 10. The value must be an integer.

## User Defined Power Cycle

The user-defined power cycle model requires that you provide data from your own power cycle model describing the cycle's performance. If you do not have such data, you should use the Rankine cycle model.

If you are modeling a supercritical Carbon dioxide (sCO<sub>2</sub>) cycle, you can use the **sCO<sub>2</sub> Cycle Integration macro** with the [NREL Supercritical Carbon Dioxide \(sCO<sub>2</sub>\) Python model](#) to generate input data for the User Defined Power Cycle model

**Note.** The inputs for the table are normalized values, where 1 is the value at the design point.

The tables use the following shorthand:

- ? **cycle:** Power cycle gross output
- Heat in:** Cycle thermal input power
- ? **cooling:** Electrical consumption for cooling
- ? **water:** Water usage

You can import performance data into each table from a text file of comma-separated values with no headers. For example, the image below shows the first few rows of the performance table with the equivalent comma-separated data in a text file:

HTF Temp.	HTF m	Ambient Temp.	W cycle	Heat in	W cooling	m water
500	0.3	43	0.143233	0.221831	1	1
504.211	0.3	43	0.146807	0.226279	1	1
508.421	0.3	43	0.150404	0.230726	1	1
512.632	0.3	43	0.154022	0.235174	1	1

**Table of Performance Data in SAM**

```
1 500,0.3,43,0.143233,0.221831,1,1
2 504.211,0.3,43,0.146807,0.226279,1,1
3 508.421,0.3,43,0.150404,0.230726,1,1
4 512.632,0.3,43,0.154022,0.235174,1,1
```

### Equivalent Data in a Text File

#### User-defined Power Cycle Parameters

**Ambient temperature, °C**

The outside air temperature at the design point.

**Cooling system water usage, kg/s**

The cooling system water mass flow rate at the design point.

**Gross power consumed by cooling system, %**

The electrical power consumed by the cooling system as a percentage of the power cycle gross output at the design point.

**Gross power consumed by cooling system, MWe**

The cooling system gross power in megawatts of electricity, equal to the product of the gross cooling power percentage and the power cycle gross output at design.

#### Performance as a Function of HTF Temperature, HTF Mass Flow Rate and Ambient Temperature

The performance as a function of hot HTF temperature, HTF mass flow rate and ambient temperature is defined in a single table that captures the relationships between these independent parameters and the 1) cycle gross electrical output power, 2) thermal input power, 3) electrical consumption for cooling and 4) water mass flow rate.

Low, design, and high parameter values for input generation:

Low HTF temperature	<input type="text" value="500"/> °C	Low normalized HTF m	<input type="text" value="0.3"/>	Low ambient temperature	<input type="text" value="0"/> °C
Design HTF temperature	<input type="text" value="574.0"/> °C	Design normalized HTF m	<input type="text" value="1.0"/>	Design ambient temperature	<input type="text" value="43.0"/> °C
High HTF temperature	<input type="text" value="580"/> °C	High normalized HTF m	<input type="text" value="1.2"/>	High ambient temperature	<input type="text" value="55"/> °C
Number of levels	<input type="text" value="20"/>	Number of levels	<input type="text" value="20"/>	Number of levels	<input type="text" value="20"/>

Generate Inputs	Import...	Export...	Copy	Paste	Rows: <input type="text" value="180"/>		
HTF Temp.	HTF m	Ambient Temp.	W cycle	Heat in	W cooling	m water	^
500	0.3	43	0.143233	0.221831	1	1	
504.211	0.3	43	0.146807	0.226279	1	1	
508.421	0.3	43	0.150404	0.230726	1	1	
512.632	0.3	43	0.154022	0.235174	1	1	

#### Custom User-defined Power Cycle Performance Data Table

The values in the table must be in accordance with the following structure but may be in any order:

Parametric Set	Number of Simulations	Custom Model Inputs		
		HTF Hot Temp	HTF Mass Flow Rate	Ambient Temperature
1	$N_{T_{HTF,hot}}$	$T_{HTF,hot}^i$ for $i = 1..N_{T_{HTF,hot}}$	$\dot{m}^-$	$T_{amb}^*$
2			$\dot{m}^*$	
3			$\dot{m}^+$	
4	$N_{\dot{m}}$	$T_{HTF,hot}^*$	$\dot{m}^i$ for $i = 1..N_{\dot{m}}$	$T_{amb}^-$
5				$T_{amb}^*$
6				$T_{amb}^+$
7	$N_{T_{HTF,amb}}$	$T_{HTF,hot}^-$	$\dot{m}^*$	$T_{amb}^i$ for $i = 1..N_{T_{amb}}$
8		$T_{HTF,hot}^*$		
9		$T_{HTF,hot}^+$		

**Custom Power Cycle Simulations Required to Populate SAM's Data Table**

To facilitate the parametric runs of the custom model, the three input parameters may be generated using the 'Generate Inputs' button. This populates the first three columns with values of the independent parameters that may be copied and used in the user's modeling software to generate the model outputs. This routine uses the Low, Design, and High values of the three independent parameters along with the desired number of respective levels.

**Low, design, and high HTF temperature**

The three hot HTF temperatures, where the design value is defined on the System Design page.

**Low, design, and high normalized HTF ?**

The three HTF mass flow rates, normalized to the design point (shown as Cycle design HTF mass flow rate under General Design Parameters above), where 1 is equivalent to the design point value.

**Low, design, and high ambient temperature**

The three ambient temperatures, where the design value is defined above under **User Defined Power Cycle Design Parameters**.

**Performance Table**

Columns 1 to 3 are the input parameters hot HTF temperature, HTF mass flow rate and ambient temperature.

Column 4 is the normalized cycle gross electrical output power.

Column 5 is the normalized thermal input power.

Column 6 is the normalized electrical consumption for cooling.

Column 7 is the water mass flow rate.

## 19.7 Thermal Storage

The parameters on the Thermal Storage page describe the properties thermal energy storage system and the storage dispatch controls.

The power tower storage model requires that the heat transfer fluid volume, tank loss coefficients, and tank temperatures be specified. SAM calculates the storage tank geometry to ensure that the storage system can supply energy to the power block at its design thermal input capacity for the number of hours specified by the Full Load TS Hours variable.

### Notes.

Because the storage capacity is not tied to the solar multiple on the [Heliostat Field page](#), be careful to choose a storage capacity that is reasonable given the system's thermal capacity. Mismatched storage and solar thermal capacities will result in high levelized cost of energy (LCOE) values.

The current version of the molten salt power tower model has a new power cycle and system dispatch model. For this version, supercritical carbon dioxide power cycle, thermocline storage, and fossil backup are not available because they were not incorporated into the new dispatch controller logic at the time of the software release. If you want to use those features, you can use the legacy version SAM 2015.6.30, available on the SAM website [Download page](#).

### System Design Parameters

The system design parameters are from the [System Design](#) page, where you can define the design-point parameters of the entire power tower system.

#### Cycle thermal power, MWt

The thermal power required at the power cycle inlet for it to operate at its design point.

$$\text{Cycle Thermal Power (MWt)} = \text{Design Turbine Gross Output (MWe)} \div \text{Cycle Thermal Efficiency}$$

#### Hours of storage at power cycle full load, hours

The nominal thermal storage capacity expressed in hours at full load: The number of hours that the storage system can supply energy at the cycle's design point.

SAM displays the equivalent storage capacity in MWht on the [System Costs](#) page.

#### HTF hot temperature, °C

The temperature of the hot heat transfer fluid at the receiver outlet when the power cycle operates at its design point.

#### HTF cold temperature, °C

The temperature of the cold heat transfer fluid at the receiver inlet when the power cycle operates at its design point.

### Storage System

#### Storage Type

SAM can model only two-tank storage systems for power towers with separate hot and cold storage tanks.

**TES thermal capacity**

The nominal thermal capacity of the storage system.

$$\text{TES Thermal Capacity} = \text{Hours of Storage at Power Cycle Full Load} \times \text{Cycle Thermal Input Power at Design}$$

**Available HTF volume, m<sup>3</sup>**

The total volume of storage fluid in both storage tanks.

SAM calculates the total heat transfer fluid volume in storage based on the storage hours at full load and the power block design turbine thermal input capacity. The total heat transfer fluid volume is divided among the total number of tanks so that all hot tanks contain the same volume of fluid, and all cold tanks contain the same volume of fluid.

**Tank height, m**

The height of the cylinder-shaped heat transfer fluid volume in each tank. SAM calculates the height based on the diameter and storage volume of a single tank.

**Tank fluid minimum height, m**

The minimum allowable height of fluid in the storage tank(s). The mechanical limits of the tank determine this value.

**Parallel tank pairs**

The number of parallel hot-cold storage tank pairs. Increasing the number of tank-pairs also increases the volume of the heat transfer fluid exposed to the tank surface, which increases the total tank thermal losses. SAM divides the total heat transfer fluid volume among all of the tanks, and assumes that each hot tank contains an equal volume of fluid, and each cold tank contains an equal volume.

**Tank diameter, m**

The diameter of the cylinder-shaped heat transfer fluid volume in each storage tank.

**Wetted loss coefficient, W/m<sup>2</sup>/K**

The thermal loss coefficient that applies to the portion of the storage tank holding the storage heat transfer fluid.

**Estimated heat loss, MWt**

Heat loss from the storage system at the design-point.

**Initial Hot HTF Percent, %**

The fraction of the storage heat transfer fluid in the hot storage tank at the beginning of the simulation.

**Cold tank heater temperature set point, °C**

The minimum allowed cold tank temperature. Whenever the heat transfer fluid temperature in storage drops below the set-point value, the system adds sufficient thermal energy from an electric tank heater to storage to reach the set-point.

**Cold tank heater capacity, MWe**

The maximum electric load of the cold tank electric heater.

**Hot tank heater temperature set point, °C**

The minimum allowed hot tank temperature. Whenever the heat transfer fluid temperature in storage drops below the set-point value, the system adds sufficient thermal energy from an electric tank heater to storage to reach the set-point.

**Hot tank heater capacity, MWe**

The maximum electric load of the hot tank electric heater.

**Tank heater efficiency**

The electric-to-thermal conversion efficiency of the hot tank and cold tank heaters.

## 19.8 System Control

The System Control inputs determine the operating parameters of the system.

**Note.** The physical trough and molten salt power tower models in SAM use a new power cycle and system dispatch model that does not support thermocline storage or fossil backup because they were not incorporated into the new dispatch controller logic. If you want to use those features, you can use the legacy version SAM 2015.6.30, available on the SAM website [Download page](#).

### Plant Energy Consumption

**Fraction of gross power consumed at all times, MWe/MWcap**

A fixed electric load applied to all hours of the simulation, expressed as a fraction of rated gross power at design from the [System Design](#) page.

**Balance of Plant Parasitic, MWe/MWcap**

Losses as a fraction of the power block nameplate capacity that apply in hours when the power block operates.

**Aux heater boiler parasitic (MWe/MWcap)**

A parasitic load that is applied as a function of the thermal output of the auxiliary fossil-fired heaters.

The BOP and auxiliary heater parasitic at design are calculated as follows:

$$\text{Parasitic Loss (MWe)} = P \text{ (MWe/MWcap)} \times F \times (C0 + C1 + C2) \times \text{Design Turbine Gross Output (MWe)}$$

### System Availability

System availability losses are reductions in the system's output due to operational requirements such as maintenance down time or other situations that prevent the system from operating as designed.

**Note.** To model curtailment, or forced outages or reduction in power output required by the grid operator, use the inputs on the [Grid Limits](#) page.

To edit the system availability losses, click **Edit losses**.

The [Edit Losses](#) window allows you to define loss factors as follows:

- Constant loss is a single loss factor that applies to the system's entire output. You can use this to model an availability factor.
- Hourly losses apply to specific hours of the year.

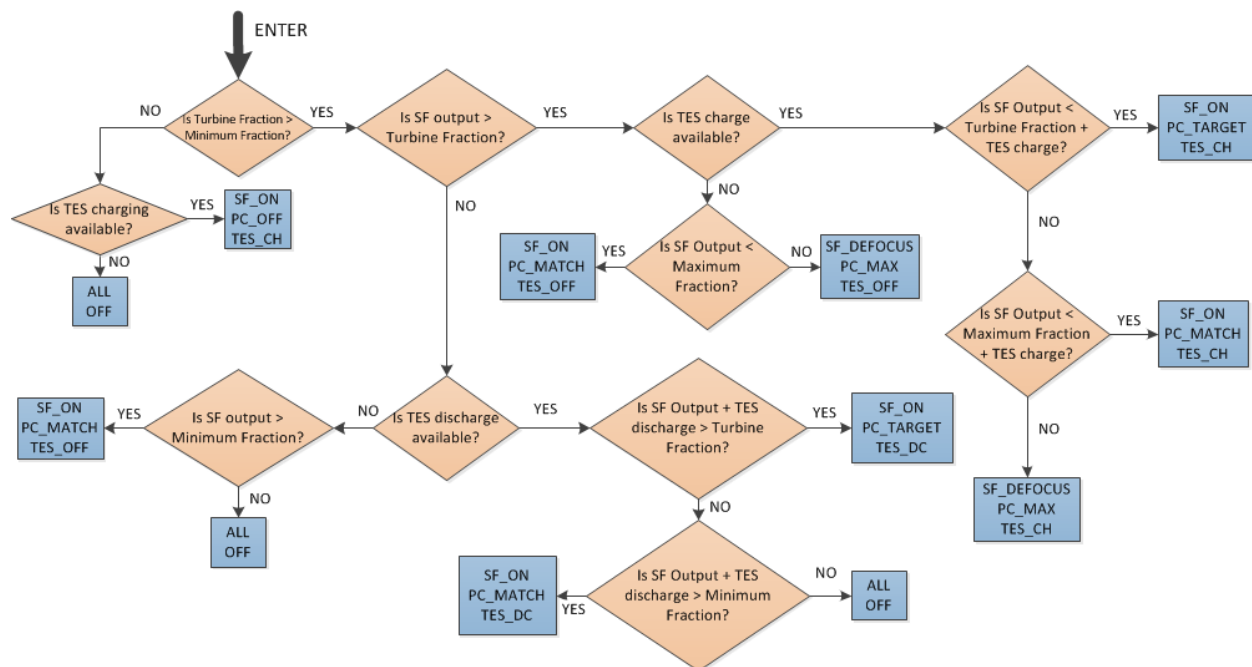
SAM reduces the system's output in each hour by the loss percentage that you specify for that hour. For a

given hour, a loss of zero would result in no adjustment. A loss of 5% would reduce the output by 5%, and a loss of -5% would increase the output value by 5%. For subhourly simulations, SAM applies the loss factor for a given hour to each time step in that hour

## Dispatch Optimization

The dispatch algorithm determines the timing of energy delivery from the solar field and to and from the thermal energy storage system. When the field is producing more thermal power than required by the power cycle during times when storage is full, the algorithm defocuses heliostats in the field to reduce the field output power. SAM reports the field optical focus fraction, receiver incident thermal power, TES charge state, and other variables in the [Results](#) that you can use to see how the system operates.

When you enable dispatch optimization, SAM automatically determines when the system defocuses heliostats in the field, stores thermal energy from the solar field, or when it dispatches thermal energy from the thermal energy storage system to the power cycle.



When you run a simulation without enabling optimization, SAM attempts to operate the system so that the power cycle output matches the dispatch schedule you define. If the turbine dispatch fraction for a given time step is greater than the minimum turbine fraction and the storage system is full, it will dispatch energy to the power cycle up to the turbine output fraction for that time step, and defocus the field if the field thermal power output exceeds the amount required.

### Enable dispatch optimization

Check the box to enable automatic optimization.

### Time horizon for dispatch optimization

The time period that SAM uses as a basis for the optimization. Default value is 48 hours.

### Frequency for dispatch reoptimization

The time period to determine how often SAM runs the optimization. Default value is 24 hours.



**Cycle startup cost penalty, \$/start**

The penalty in the dispatch optimization algorithm associated with starting up the power cycle. The cost is applied any time the power cycle goes from an “off” state to an “on” or “standby” state in the next time period. This penalty affects the optimal solution, which seeks to maximize revenue. This value *does not* affect actual O&M costs or the calculated SAM financial metrics.

**Receiver startup cost penalty, \$/start**

The penalty in the dispatch optimization algorithm associated with starting up the solar field and receiver. The cost is applied any time the solar field goes from an “off” state to an “on” state in the next time period. This penalty affects the optimal solution, which seeks to maximize revenue. This value *does not* affect actual O&M costs or the calculated SAM financial metrics.

**Power generation ramping penalty**

The penalty imposed for changing power cycle electrical production from one time step to the next. By penalizing changes, the resulting dispatch profile exhibits improved stability and is potentially more realizable in practice. Increasing this penalty may reduce achieved revenue for the project. This penalty affects the optimal solution, which seeks to maximize revenue. This value does not affect actual O&M costs or the calculated SAM financial metrics.

**Objective function time weighting exponent**

The relative weight due to time in the dispatch optimization objective function. A weighting factor of 0.99 indicates that the objective function terms are multiplied by  $0.99^t$  for each timestep  $t$  in the optimization horizon (48 hours, by default). A value of 1.0 indicates no time weighting, a value less than one indicates that – all things equal – generation is preferred sooner than later, and a value greater than one indicates that generation is preferred later than sooner. As the value is displaced from unity, the optimization algorithm is typically able to solve the dispatch problem more quickly, but the resulting revenue may decrease. Note that a value of 0.99 corresponds to an objective discounting in the 24th time period (one day ahead) of  $0.99^{24} = 0.79$ , which is to say that the optimization routine values revenue generated in hour one 21% more than in hour 24, though revenue multipliers and efficiency terms may be identical.

**Maximum branch and bound iterations**

Limits the number of iterations in the optimization routine. If you are experiencing problems with the optimization, you can increase the number. The default value is 30,000.

**Solution optimality gap tolerance**

Determines the tolerance for the optimization solution. You can decrease the tolerance if you are experiencing problems with the optimization. Default value is 0.001.

**Optimization solver timeout limit, seconds**

Limits the amount of time the optimization will attempt to find a solution. You can increase the timeout limit if you are experiencing problems with the optimization. Default value is 5 seconds.

**Max. net power to the grid (MWe)**

The maximum allowable net power to the grid when running dispatch optimization. Use a value much greater than the power cycle nameplate capacity to remove the effect of this constraint.

SAM determines approximate parasitic loads and the approximate gross cycle generation at each time period in the forecast horizon, and limits the net output to be less than or equal to this value. If the net power production cannot reach the specified limit, either because insufficient energy is available for power generation or because the power cycle operation envelope does not allow for sufficiently high output, the constraint will not be applied.

### Max. net power to the grid (incl. availability), MWe

A calculated value that indicates the max. net power to the grid after power cycle availability losses are accounted for. The calculated value is the product of the max.net power to the grid and the constant term in the [Edit Losses](#) window on the System Control page. Note that hourly or hourly-block availability options are not included in this calculation, and only the constant is considered. When running a simulation with dispatch optimization enabled and the maximum power constraint in effect, the net production in the hourly data viewer will most closely equal this calculated value.

## Dispatch Control

The dispatch control periods determine the timing of adjustments to the power cycle output.

**Note.** If your analysis involves PPA price multipliers defined on the [Time of Delivery \(TOD\) Factors](#) page, you should verify that the dispatch control schedules are consistent with the TOD factor schedules.

### Use output fraction as maximum cycle output

Check this box if you want to limit the power cycle output to the turbine output fraction you specify for dispatch control instead of the **Maximum turbine over design operation** on the Power Cycle page. If you do not check the box and the turbine over design operation is greater than the highest turbine output fraction, the power cycle may operate at the higher value, exceeding the maximum dispatch limit under some conditions.

### Turbine output fraction

For each of up to nine time-of-delivery periods, specify a multiple of the power cycle thermal input to scale the system's electrical output up or down as desired to match power pricing schedules or other time-dependent constraints.

### Hybrid cooling fraction

For each of up to nine time-of-delivery periods, specify how much of the cooling load should be handled by the wet-cooling system. Each value in the table is a fraction of the design cooling load. For example, if you want 60% of heat rejection load to go to wet cooling in Period 1, type 0.6 for Period 1. Directing part of the heat rejection load to the wet cooling system reduces the total condenser temperature and improves performance, but increases the water requirement. SAM sizes the wet-cooling system to match the maximum fraction that you specify in the hybrid dispatch table, and sizes the air-cooling system to meet the full cooling load.

## Defining Dispatch Schedules

The storage dispatch schedules determine when each of the nine periods apply during weekdays and weekends throughout the year.

If your analysis includes [PPA price multipliers](#) and you want to use the same schedule for the multipliers and for the power cycle dispatch control, click **Copy schedule from TOD Factors** page to apply the TOD Factors schedule matrices to the dispatch schedule matrices.

### To specify a weekday or weekend schedule:

1. Assign values as appropriate to the **Turbine output fraction** and **Hybrid cooling fraction** for each of the up to nine periods.
2. Use your mouse to draw a rectangle in the matrix for the first block of time that applies to period 2.

	12am	1am	2am	3am	4am	5am	6am	7am	8am	9am	10am	11am	12pm	1pm	2pm	3pm	4pm	5pm	6pm	7pm	8pm	9pm	10pm	11pm
Jan	1	1	1	1	1	1	1	1	1	1	1	1	1	1	1	1	1	1	1	1	1	1	1	1
Feb	1	1	1	1	1	1	1	1	1	1	1	1	1	1	1	1	1	1	1	1	1	1	1	1
Mar	1	1	1	1	1	1	1	1	1	1	1	1	1	1	1	1	1	1	1	1	1	1	1	1
Apr	1	1	1	1	1	1	1	1	1	1	1	1	1	1	1	1	1	1	1	1	1	1	1	1
May	1	1	1	1	1	1	1	1	1	1	1	1	1	1	1	1	1	1	1	1	1	1	1	1
Jun	1	1	1	1	1	1	1	1	1	1	1	1	1	1	1	1	1	1	1	1	1	1	1	1
Jul	1	1	1	1	1	1	1	1	1	1	1	1	1	1	1	1	1	1	1	1	1	1	1	1
Aug	1	1	1	1	1	1	1	1	1	1	1	1	1	1	1	1	1	1	1	1	1	1	1	1
Sep	1	1	1	1	1	1	1	1	1	1	1	1	1	1	1	1	1	1	1	1	1	1	1	1
Oct	1	1	1	1	1	1	1	1	1	1	1	1	1	1	1	1	1	1	1	1	1	1	1	1
Nov	1	1	1	1	1	1	1	1	1	1	1	1	1	1	1	1	1	1	1	1	1	1	1	1
Dec	1	1	1	1	1	1	1	1	1	1	1	1	1	1	1	1	1	1	1	1	1	1	1	1

3. Type the number 2.

	12am	1am	2am	3am	4am	5am	6am	7am	8am	9am	10am	11am	12pm	1pm	2pm	3pm	4pm	5pm	6pm	7pm	8pm	9pm	10pm	11pm
Jan	1	1	1	1	1	1	1	1	1	1	1	1	1	1	1	1	1	1	1	1	1	1	1	1
Feb	1	1	1	1	1	1	1	1	1	1	1	1	1	1	1	1	1	1	1	1	1	1	1	1
Mar	1	1	1	1	1	1	1	1	1	1	1	1	1	1	1	1	1	1	1	1	1	1	1	1
Apr	1	1	1	1	1	1	1	1	1	1	1	1	1	1	1	1	1	1	1	1	1	1	1	1
May	1	1	1	1	1	1	1	1	1	1	2	2	2	2	2	2	1	1	1	1	1	1	1	1
Jun	1	1	1	1	1	1	1	1	1	1	2	2	2	2	2	2	1	1	1	1	1	1	1	1
Jul	1	1	1	1	1	1	1	1	1	1	2	2	2	2	2	2	1	1	1	1	1	1	1	1
Aug	1	1	1	1	1	1	1	1	1	1	2	2	2	2	2	2	1	1	1	1	1	1	1	1
Sep	1	1	1	1	1	1	1	1	1	1	1	1	1	1	1	1	1	1	1	1	1	1	1	1
Oct	1	1	1	1	1	1	1	1	1	1	1	1	1	1	1	1	1	1	1	1	1	1	1	1
Nov	1	1	1	1	1	1	1	1	1	1	1	1	1	1	1	1	1	1	1	1	1	1	1	1
Dec	1	1	1	1	1	1	1	1	1	1	1	1	1	1	1	1	1	1	1	1	1	1	1	1

4. SAM shades displays the period number in the squares that make up the rectangle, and shades the rectangle to match the color of the period.

**Dispatch Control**

[Copy schedule from TOD Factors page](#)

Turbine output fraction

Period 1:

Period 2:

Period 3:

Period 4:

Period 5:

Period 6:

Period 7:

Period 8:

Period 9:

The turbine output fraction scales the turbine thermal input relative to design for the corresponding time-of-use period.

Use the schedule matrices to specify the month and hour of day for each of the nine periods.

**Weekday Schedule**

	12am	1am	2am	3am	4am	5am	6am	7am	8am	9am	10am	11am	12pm	1pm	2pm	3pm	4pm	5pm	6pm	7pm	8pm	9pm	10pm	11pm
Jan	1	1	1	1	1	1	1	1	1	1	1	1	1	1	1	1	1	1	1	1	1	1	1	1
Feb	1	1	1	1	1	1	1	1	1	1	1	1	1	1	1	1	1	1	1	1	1	1	1	1
Mar	1	1	1	1	1	1	1	1	1	1	1	1	1	1	1	1	1	1	1	1	1	1	1	1
Apr	1	1	1	1	1	1	1	1	1	1	1	1	1	1	1	1	1	1	1	1	1	1	1	1
May	1	1	1	1	1	1	1	1	1	1	2	2	2	2	2	2	1	1	1	1	1	1	1	1
Jun	1	1	1	1	1	1	1	1	1	1	2	2	2	2	2	2	1	1	1	1	1	1	1	1
Jul	1	1	1	1	1	1	1	1	1	1	2	2	2	2	2	2	1	1	1	1	1	1	1	1
Aug	1	1	1	1	1	1	1	1	1	1	2	2	2	2	2	2	1	1	1	1	1	1	1	1
Sep	1	1	1	1	1	1	1	1	1	1	1	1	1	1	1	1	1	1	1	1	1	1	1	1
Oct	1	1	1	1	1	1	1	1	1	1	1	1	1	1	1	1	1	1	1	1	1	1	1	1
Nov	1	1	1	1	1	1	1	1	1	1	1	1	1	1	1	1	1	1	1	1	1	1	1	1
Dec	1	1	1	1	1	1	1	1	1	1	1	1	1	1	1	1	1	1	1	1	1	1	1	1

5. Repeat Steps 2-4 for each of the remaining periods that apply to the schedule.

## Operating Modes

The power tower model reports a set of operating mode outputs indicating how the system operates in each time step. The controller may divide a time step into different operating modes. For example the startup time step may involve three operating modes: Operating Mode 2 as the receiver warms up and the power cycle is off, followed by Operating Mode 32 when the receiver is on and hot HTF is delivered to both the power cycle for startup and TES, and then by Operating Mode 11 when the receiver is on and hot HTF is delivered to both the power cycle for power generation and TES for charging. The controller reports the first three operating modes and the number of modes for each time step. Most time steps will require three or fewer modes. In some rare cases, a time step may require more than three modes.

The operating modes output variables are:

### 1st operating mode

The operating mode at the beginning of the time step.

### 2nd op. mode, if applicable

If the operating mode changes within the time step, the second operating mode follows the first operating mode.

### 3rd op mode, if applicable

If the operating mode changes three times within the time step, the third operating mode follows the second operating mode.

### Operating modes in reporting timestep

The number of operating modes in a given time step.

In each time step, the power tower plant controller uses an iterative process to search for the operating mode that best achieves target plant output. The target plant output is either determined from the **Turbine output fraction** for the time step that you specify under **Dispatch Control**, or, if you check **Enable dispatch optimization** under **Dispatch Optimization**, it is automatically optimized. For example, for a time step when the receiver output power is very close to but slightly less than the thermal power required for the power cycle to generate power at the target level, the controller might try Operating Mode 11 where the receiver delivers hot HTF to both the power cycle and TES and determine that is not enough energy to meet the cycle target. The controller would then it try Operating Mode 12 that discharges a small amount of energy from TES to supplement the energy from the receiver and meet the cycle target. If the cycle target is met, the **First 3 operating modes tried** would be 1112 to represent the controller trying Operating Mode 11 followed by Operating Mode 12.

In most cases, the controller will only need to consider up to three attempts, and it reports up to nine attempts. The output variables indicating operating modes considered by the controller are listed below. Note that modes 1-9 are indicated as 10, 20, 30, ... 90.

### First 3 operating modes tried

The numbers of the first of up to three operating modes tested in a given time step to find the best operating mode. For example, if operating modes 11 and 12 were tried, the value would be 1112.

### Next 3 operating modes tried

If the controller tried more than three operating modes, the mode numbers up to three additional attempts.

**Final 3 operating modes tried**

If the controller tried more than six operating modes, the mode numbers for up to three additional attempts.

The 34 operating modes are described in the table below. Note that single digit operating modes 1-9 are shown as 10, 20, etc. in the "operating modes tried" variables.

Operating Mode	Description
1 (10)	CR_OFF, PC_OFF, TES_OFF, AUX_OFF
2 (20)	CR_SU, PC_OFF, TES_OFF, AUX_OFF
3 (30)	CR_ON, PC_SU, TES_OFF, AUX_OFF
4 (40)	CR_ON, PC_SB, TES_OFF, AUX_OFF
5 (50)	CR_ON, PC_RM_HI, TES_OFF, AUX_OFF
6 (60)	CR_ON, PC_RM_LO, TES_OFF, AUX_OFF
7 (70)	CR_DF, PC_MAX, TES_OFF, AUX_OFF
8 (80)	CR_OFF, PC_SU, TES_DC, AUX_OFF
9 (90)	CR_ON, PC_OFF, TES_CH, AUX_OFF
10	SKIP_10 (not used)
11	CR_ON, PC_TARGET, TES_CH, AUX_OFF
12	CR_ON, PC_TARGET, TES_DC, AUX_OFF
13	CR_ON, PC_RM_LO, TES_EMPTY, AUX_OFF
14	CR_DF, PC_OFF, TES_FULL, AUX_OFF
15	CR_OFF, PC_SB, TES_DC, AUX_OFF
16	CR_OFF, PC_MIN, TES_EMPTY, AUX_OFF
17	CR_OFF, PC_RM_LO, TES_EMPTY, AUX_OFF
18	CR_ON, PC_SB, TES_CH, AUX_OFF
19	CR_SU, PC_MIN, TES_EMPTY, AUX_OFF
20	SKIP_20 (not used)
21	CR_SU, PC_SB, TES_DC, AUX_OFF
22	CR_ON, PC_SB, TES_DC, AUX_OFF
23	CR_OFF, PC_TARGET, TES_DC, AUX_OFF
24	CR_SU, PC_TARGET, TES_DC, AUX_OFF
25	CR_ON, PC_RM_HI, TES_FULL, AUX_OFF
26	CR_ON, PC_MIN, TES_EMPTY, AUX_OFF
27	CR_SU, PC_RM_LO, TES_EMPTY, AUX_OFF
28	CR_DF, PC_MAX, TES_FULL, AUX_OFF
29	CR_ON, PC_SB, TES_FULL, AUX_OFF
30	SKIP_30 (not used)
31	CR_SU, PC_SU, TES_DC, AUX_OFF
32	CR_ON, PC_SU, TES_CH, AUX_OFF
33	CR_DF, PC_SU, TES_FULL, AUX_OFF
34	CR_DF, PC_SU, TES_OFF, AUX_OFF

## 19.9 System Costs

SAM uses the variables on the Tower System Costs page to calculate the project investment cost and annual operating costs reported in the project [cash flow](#) and used to calculate cost metrics reported in the Metrics table on the [Results page](#).

Because only the total installed cost value affects the cash flow calculations, you can assign capital costs to the different cost categories in whatever way makes sense for your analysis. For example, you could assign the cost of designing the solar field to the solar field cost category or to the engineer-procure-construct category with equivalent results. The categories are provided to help you keep track of the different costs, but do not affect the economic calculations. After assigning costs to the categories, verify that the total installed costs value is what you expect.

Variable values in boxes with white backgrounds are values that you can edit. Boxes with blue backgrounds contain calculated values or values from other pages that SAM displays for your information.

### CSP System Cost Notes.

The default cost values that appear when you create a file or case are intended to illustrate SAM's use. The cost data are meant to be realistic, but not to represent actual costs for a specific project. For more information and a list of online resources for cost data, see the [SAM website](#).

The direct capital costs in \$/kWe are in kilowatts of gross power block capacity rather than nameplate capacity because the size and cost of the power block is determined by the gross capacity, not the net capacity. The total installed cost in \$/kWe (actually overnight installed cost because it does not include financing during construction costs, which are accounted for on the [Financial Parameters](#) page) is in kilowatts of nameplate capacity, because that is what is delivered to the grid and is consistent with how costs are reported for utility generation technologies. The indirect costs in \$/Wac are in Watts of nameplate power block capacity because those costs that use the entire plant as the basis, not just the power block.

The System Costs page only available for cases with a cash-flow-based financial mode. It is not available with the No Financial Model option or the LCOE Calculator financial model.

### Direct Capital Costs

A direct capital cost represents an expense for a specific piece of equipment or installation service that applies in year zero of the cash flow.

**Note:** Because SAM uses only the total installed cost value in cash flow calculations, how you distribute costs among the different direct capital cost categories does not affect the final results.

#### Site Improvements (\$/m<sup>2</sup>)

A cost per square meter of total reflective area from the Heliostat Field page to account for expenses related to site preparation and other equipment not included in the heliostat field cost category.

**Heliostat Field (\$/m<sup>2</sup>)**

A cost per square meter of total reflective area from the Heliostat Field page to account for expenses related to installation of the heliostats, including heliostat parts, field wiring, drives, labor, and equipment.

**Balance of Plant (\$/kWe)**

A cost per electric kilowatt of power cycle gross capacity from the Power Cycle page expenses related to installation of the balance-of-plant components and controls, and construction of buildings, including labor and equipment.

**Power Block (\$/kWe)**

A cost per electric kilowatt of power cycle gross capacity from the Power Cycle page expenses related to installation of the power block components, including labor and equipment. The Power Block and Balance of Plant costs are rolled together into a single number for calculation purposes.

**Fossil Backup (\$/kWe)**

Cost per electric kilowatt of power block gross capacity to account for the installation of a fossil backup system, including equipment and labor.

**Storage (\$/kWh)**

Cost per thermal megawatt-hour of storage capacity from the Thermal Storage page to account for the installation of a thermal energy storage system, including equipment and labor.

**Fixed Solar Field Cost (\$)**

An additional fixed cost in dollars to include as a direct cost that is not accounted for by any of the above categories.

**Fixed Tower Cost (\$)**

A fixed cost to account for tower construction, materials and labor costs. The fixed tower cost serves as the multiplier in the tower cost scaling equation shown below.

**Tower Cost Scaling Exponent**

SAM uses the tower cost in the optimization calculations. The tower cost scaling exponent defines the nonlinear relationship between tower cost and tower height. See Total Tower Cost below.

**Total Tower Cost (\$)**

Total Tower Cost = Fixed Tower Costs x  $e^{( \text{Tower Cost Scaling Exponent} \times ( \text{Tower Height} - \text{Receiver Height} \div 2 + \text{Heliostat Height} \div 2 ) )}$

**Receiver Reference Cost (\$)**

The cost per receiver reference area to account for receiver installation costs, including labor and equipment.

**Receiver Reference Area (m<sup>2</sup>)**

The receiver area on which the receiver reference cost is based.

**Receiver Cost Scaling Exponent**

SAM uses the receiver cost in the optimization calculations. The receiver cost scaling exponent defines the nonlinear relationship between receiver cost and receiver area based on the reference cost conditions provided.



**Total Receiver Cost (\$)**

Receiver Cost = Receiver Reference Cost x ( Receiver Area / Receiver Reference Area ) ^ Receiver Cost Scaling Exponent

**Contingency (%)**

A percentage of the sum of the site improvements, heliostat field, balance of plant, power block, storage system, fixed solar field, total tower, and total receiver costs to account for expected uncertainties in direct cost estimates.

**Total Direct Cost (\$)**

The sum of improvements, site improvements, heliostat field, balance of plant, power block, storage system, fixed solar field, total tower, total receiver, and contingency costs.

**Indirect Capital Costs**

An indirect cost is typically one that cannot be identified with a specific piece of equipment or installation service.

**Note:** Because SAM uses only the total installed cost value in cash flow calculations, how you distribute costs among the different indirect capital cost categories does not affect the final results.

**Total Land Area**

The total land area required for the project, from the Solar Field or Heliostat Field page.

**Nameplate**

The system's nameplate capacity from the Power Block or Power Cycle page.

**EPC and Owner Cost**

EPC (engineer-procure-construct) and owner costs are associated with the design and construction of the project. SAM calculates the total cost as the sum of the Non-fixed Cost and Fixed Cost.

Typical costs that may be appropriate to include in the EPC and Owner category are: Permitting, royalty payments, consulting, management or legal fees, geotechnical and environmental surveys, interconnection costs, spare parts inventories, commissioning costs, and the owner's engineering and project development activities.

**Total Land Costs**

Costs associated with land purchases, which SAM calculates as the sum of a non-fixed cost and a fixed cost. Use the Land category described below for land costs, and inputs on the [Financial Parameters](#) page for financing costs.

SAM calculates the total EPC and Owner Costs and Total Land Costs by adding the four costs that you can specify using different units.

**\$/acre**

A cost in dollars per total land area in acres.

**% of direct cost**

A cost as a percentage of **Total Direct Cost** under **Direct Capital Cost**.

**\$/Wac**

A cost in dollars per AC Watt of nameplate capacity.

\$

A fixed dollar amount

## Sales Tax

### Sales tax basis, %

The percentage of total direct cost used to calculate sales tax amount.

SAM calculates the total sales tax amount by multiplying the sales tax rate from the [Financial Parameters](#) page by the sales tax basis on the System Costs page:

$$\text{Total Sales Tax (\$)} = \text{Sales Tax Rate (\%)} \times \text{Sales Tax Basis (\%)} \times \text{Total Direct Cost (\$)}$$

For an explanation of the effect of sales tax on income tax, see **Sales Tax** on the [Financial Parameters](#) topic for the financial model you are using (Residential, Commercial, Single Owner, etc.)

### Total Indirect Cost (\$)

The sum of engineer-procure-construct costs, project-land-miscellaneous costs, and sales tax.

## Total Installed Cost

The total installed cost is the sum of all of the direct and indirect capital costs that you specify. SAM uses this value to calculate the project's [net capital cost](#), which is the total installed cost less any cash incentives on the [Incentives](#) page and plus any additional financing costs from [Financial Parameters](#) page.

### Total installed cost (\$)

The sum of total direct cost and total indirect cost.

### Total installed cost per capacity (\$/Wdc or \$/kW)

Total installed cost divided by the total system rated or nameplate capacity. This value is provided for reference only. SAM does not use it in cash flow calculations.

## Operation and Maintenance Costs

Operation and Maintenance (O&M) costs represent annual expenditures on equipment and services that occur after the system is installed. SAM allows you to enter O&M costs in three ways: Fixed annual, fixed by capacity, and variable by generation. O&M costs are reported on the project [cash flow](#).

For each O&M cost category, you can specify an optional annual **Escalation Rate** to represent an expected annual increase in O&M cost above the annual inflation rate specified on the [Financial Parameters](#). For an escalation rate of zero, the O&M cost in years two and later is the year one cost adjusted for inflation. For a non-zero escalation rate, the O&M cost in years two and later is the year one cost adjusted for inflation plus escalation.

For expenses such as component replacements that occur in particular years, you can use an annual schedule to assign costs to individual years. See below for details.

### Fixed Annual Cost (\$/yr)

A fixed annual cost that applied to each year in the project cash flow.

### Fixed Cost by Capacity (\$/kW-yr)

A fixed annual cost proportional to the system's rated or nameplate capacity.

### Variable Cost by Generation (\$/MWh)

A variable annual cost proportional to the system's total annual electrical output in AC megawatt-hours.

The annual energy output depends on either the performance model's calculated first year value and the **degradation rate** from the [Lifetime](#) page, or on an annual schedule of costs, depending on the option chosen.

#### Fossil Fuel Cost (\$/MMBtu)

The cost per million British thermal units for fuel. SAM uses the conversion factor 1 MWh = 3.413 MMBtu. SAM calculates a fossil fuel cost for concentrating solar power systems with fossil backup, and for the generic system when the heat rate on the [Power Plant](#) page is not zero.

**Note.** If you are using the [generic system](#) model to represent a system that does not consume fuel, you should use a fuel cost of zero.

**Note.** For information on water consumption and other operation and maintenance costs and requirements for concentrating parabolic trough systems, see the Troughnet website: [http://www.nrel.gov/csp/troughnet/power\\_plant\\_systems.html](http://www.nrel.gov/csp/troughnet/power_plant_systems.html). For information on operation and maintenance costs for photovoltaic systems, see the California Energy Commission's online Distributed Energy Resource guide <http://www.energy.ca.gov/distgen/economics/operation.html>.

### Entering Periodic Operation and Maintenance Costs

SAM allows you to specify any of the four operation and maintenance (O&M) cost categories on the System Costs page either as a single annual cost, or using a table of values to specify an annual schedule of costs. An annual schedule makes it possible to assign costs to particular years in the analysis period. Annual schedules can be used to account for component replacement costs and other periodic costs that do not recur on a regular annual basis.

You choose whether to specify an O&M cost as a single annual value or an annual schedule with the grey and blue button next to each variable. SAM uses the option indicated by the blue highlight on the button: A blue highlighted "Value" indicates a single, regularly occurring annual value. A blue highlighted "Sched" indicates that the value is specified as an annual schedule.

For example, to account for component replacement costs, you can specify the fixed annual cost category as an annual schedule, and assign the cost of replacing or rebuilding the component to particular years. For a 30-year project using a component with a seven-year life, you would assign a replacement cost to years seven, 14, and 21. Or, to account for expected improvements in the component's reliability in the future, you could assign component replacement costs in years seven, 17, and 27. After running a simulation, you can see the replacement costs in the project [cash flow](#) in the appropriate column under Operating Expenses. SAM accounts for the operating costs in the other economic metrics including the levelized cost of energy and net present value (NPV).

#### Notes.

If you use the annual schedule option to specify equipment replacement costs, SAM does not calculate any residual or salvage value of system components based on the annual schedule. SAM calculates salvage value separately, using the salvage value you specify on the [Financial Parameters](#) page.

Dollar values in the annual schedule are in nominal or current dollars. SAM does not apply inflation and escalation rates to values in annual schedules.

The following procedure describes how to define the fixed annual cost category as an annual schedule. You can use the same procedure for any of the other operation and maintenance cost categories.

**To assign component replacement costs to particular years:**

1. In the Fixed Annual Cost category, note that the "Value" label of the grey and blue button is blue indicating that the single value mode is active for the variable.

Fixed Annual Cost   \$/yr

In this case, SAM would assign an annual cost of \$284 to each year in the project cash flow.

2. Click the button so that "Sched" label is highlighted in blue. SAM replaces the variable's value with an Edit button.

3. Click **Edit** to open the [Edit Schedule](#) window.
4. In the Edit Schedule window, use the vertical scroll bar to find the year of the first replacement, and type the replacement cost in current or constant dollars for that year.

To delete a value, select it and press the Delete key on your keyboard.

**Note.** You must type a value for each year. If you delete a value, SAM will clear the cell, and you must type a number in the cell or SAM will consider the schedule to be invalid. Type a zero for years with no annual costs.

5. When you have finished editing the schedule, click **Accept**.

Because you must specify an O&M cost category as either an annual cost or annual schedule, to assign both a recurring annual fixed cost and periodic replacement cost, you must type the recurring cost in each year of the annual schedule, and for years with replacement costs, type the sum of the recurring and replacement costs.

**About the CSP Default Cost Assumptions**

The default values the System Costs page for the CSP models reflect the National Renewable Energy Laboratory's best estimate of representative costs for CSP systems in the United States at the time of the release of the current version of SAM. The values are based on cost studies undertaken by NREL, review of published literature, and conversations with developers and industry insiders. Costs are reviewed prior to each new SAM release.

**Note.** Always review all of the inputs for your SAM project to determine whether they are appropriate for your analysis.

The parabolic trough and power tower system cost default values were largely developed from the following studies:

- Kurup, P.; Turchi, C. S. (2015). "Parabolic Trough Collector Cost Update for the System Advisor Model (SAM)," NREL/TP-6A20-65228, 2015. ([PDF 2.1 MB](#))
- Turchi, C. S.; Heath, G. A. (2013). "Molten Salt Power Tower Cost Model for the System Advisor Model (SAM)," NREL/TP-5500-57625, 2013. ([PDF 2.5 MB](#))
- Kolb, G. J.; Ho, C. K. (2011), T. R. Mancini, and J. A. Gary, "Power Tower Technology Roadmap and Cost Reduction Plan," SAND2011-2419. ([PDF 503 KB](#))
- Turchi, C. S. (2010). "Parabolic Trough Reference Plant for Cost Modeling with the Solar Advisor Model (SAM)," NREL/TP-550-47605. ([PDF 7.2 MB](#))

These studies differed in some important assumptions. The differences in the location and cooling method

assumptions for the default cases of the CSP technologies are outlined in the following table. The choice of location affects solar resource and the assumed labor costs associated with the case. Construction labor rates in Arizona tend to be lower than in California, which reduces installed costs. For the Winter 2016 version of SAM, all CSP systems are assumed to use dry cooling. SAM can model systems with dry cooling, wet cooling, or a hybrid of the two. If you change the type of cooling system on the Power Cycle input page, you should also change other parameters as appropriate because SAM does not make those changes automatically. For example, different types of cooling systems would require different power cycle costs and design-point performance parameters. Perhaps less obvious, the site preparation costs are lower for dry-cooled (air-cooled) systems than for wet-cooled (evaporative) systems because of the elimination of the large blowdown evaporation ponds required for wet systems.

Technology	Default Location	Default Cooling method
Physical Trough	SW Arizona (Tucson weather file)	Dry
Empirical Trough	SW Arizona (Tucson weather file)	Dry
Molten Salt Power Tower	Southern California (Daggett weather file)	Dry
Linear Fresnel	SW Arizona (Tucson weather file)	Dry
Generic Solar	SW Arizona (Tucson weather file)	Dry

The trough, tower, and linear Fresnel models assume the “balance of plant” cost category is composed of the steam generation system (Kolb, 2011). This choice is made to allow users to highlight the effect of a direct steam generation (DSG) design. In a DSG design, the balance of plant cost category is zero because steam generation occurs in the solar receiver.

The lesser commercial activity in linear Fresnel systems makes cost values for those technologies more uncertain than for troughs and towers. Linear Fresnel costs are estimated based on discussions with developers and researchers.

## 20 CSP Linear Fresnel

For a linear Fresnel system, choose either the [molten salt linear Fresnel model](#) or the [direct steam linear Fresnel](#) model.

Both models use the same set of inputs for [location and resource](#) and [system costs](#).

## 20.1 Location and Resource

The Location and Resource page provides access to the solar resource library, which is a collection of weather files stored on your computer. When you first install SAM, it comes with a few default weather files in the library. As you use SAM for your own projects, you should add files to build your own library. Once files are in your library, you can use them for different projects and with different versions of SAM.

**Solar Resource Library**  
The Solar Resource library is a list of weather files stored on your computer, or use the tools below to add files to the library.

Search for:  Name

Name	Latitude	Longitude	Time zone	Elevation	Station ID
daggett_ca_34.865371_-116.783023_psmv3_60_tmy	34.85	-116.78	-8	561	91486
des_moines_ia_41.586835_-93.624959_psmv3_60_tmy	41.57	-93.62	-6	263	757516
faroo nd 46.9 -96.8 mts1 60 tmy	46.9	-96.8	-6	274	14914

SAM scans the following folders on your computer for valid weather files to add to the solar resource library. To use weather files stored on your computer, add folders containing the files.

C:\Users\<user>\SAM Downloaded Weather Files  
F:\little\_rock\_ar  
F:\PVGIS 5

Add/remove weather file folders...  
Refresh library

**Choose a weather file from the library.**

**List of solar resource folders.**

**Weather file for simulation.**

**Information from weather file header.**

**Summary data calculated from time series data.**

**Weather Data Information**  
The following information describes the weather file selected from the Solar Resource library above. This is the file SAM will use when you click Simulate.

Weather file: C:\SAM\2018.10.29\solar\_resource\daggett\_ca\_34.865371\_-116.783023\_psmv3\_60\_tmy.csv

**Header Data from Weather File**

City	Station ID	Latitude
-	91486	34.85 °N
State	Data Source	Longitude
-	NSRDB	-116.78 °E
Country	Elevation	Time zone
-	561 m	GMT -8

**Annual Averages Calculated from Weather File Data**

Global horizontal	NaN kWh/m <sup>2</sup> /day	Average temperature	17.3 °C
Direct normal (beam)	7.65 kWh/m <sup>2</sup> /day	Average wind speed	2.4 m/s
Diffuse horizontal	1.27 kWh/m <sup>2</sup> /day		

\*NaN indicates missing data.

There are two ways to add files to your solar resource library:

### 1. Download files from the NREL National Solar Radiation Database (NSRDB)

Use the download weather file options and click **Download and add to library** to get the most up-to-date data from the NSRDB for long-term cash flow analysis, single-year analysis, and P50/P90 analysis.

### 2. Add weather file folders

If you have weather files from a source other than the NSRDB or that you've downloaded yourself directly from the NSRDB website, click **Add/remove weather file folders** to add the folder containing the files to the **Solar Data File Folders** list. SAM automatically adds any weather files it finds in these folders to the solar resource library so they will appear in the list.

When you install SAM, it creates the default download folder <user>/SAM Downloaded Weather Files

folder where weather files you download from the NSRDB are stored. You can change that folder by clicking **Add/remove weather file folders** and changing the **Folder for Downloaded Solar Data Files**.

For locations not in the NSRDB, you can download weather files in the EPW format from the European Commission Photovoltaic Geographical Information System [PVGIS V5 website](#).

## See also

[Weather File Formats](#)

[Weather Data Elements](#)

[Typical and Single Year](#)

[Time and Sun Position](#)

[Folders and Libraries](#)

[Weather Data and LK](#)

### Notes.

You may want to model your system using weather data from several different sources and locations around your project site to understand how sensitive your analysis results are to the weather assumptions, and how much variation there is in the data from the different weather files.

You can compare results for a system using more than one weather file in a single case by using SAM's [parametric simulation](#) option.

For more information about weather data, including where to find data for locations outside of the United States, see [Weather Data](#) on the SAM website.

For a helpful discussion of weather data and power system simulation, see Sengupta, M.; Habte, A.; Gueymard, C.; Wilbert, S.; Renne, D.; Stoffel, T. (2017). "Best Practices Handbook for the Collection and Use of Solar Resource Data for Solar Energy Applications: Second Edition." NREL Report No. TP-5D00-68886. ([PDF 8.1 MB](#))

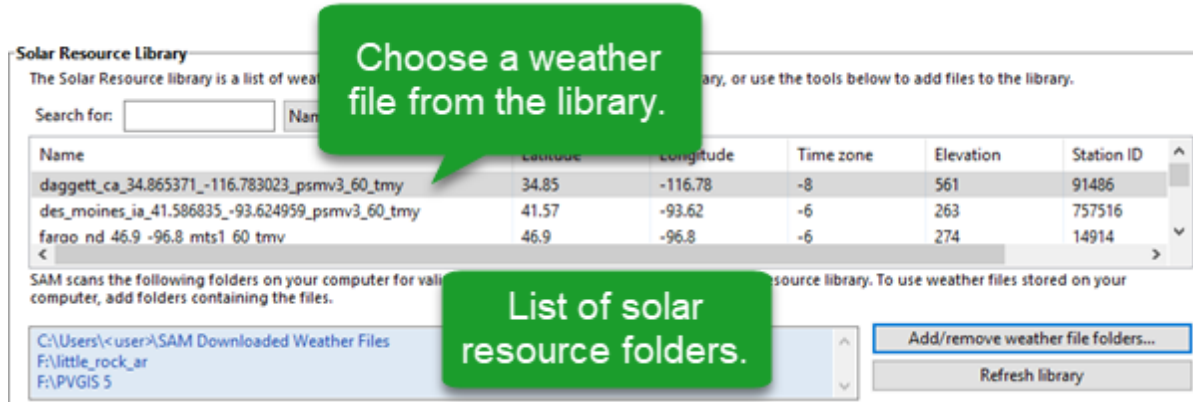
## ▼ Solar Resource Library

SAM's solar resource library displays information from weather files in your solar resource data folders. The default solar resource library that comes with SAM contains weather files for a few locations around the United States for the default configurations. As you use SAM, use **Add/remove weather file folders** to build a library of files for locations you frequently use as described in [Folders and Libraries](#).

### **To choose a file from the solar resource library:**

- Click the location name in the list. You can type a few letters of the file name in the Search box to filter the list.

The full file name and information about the selected file appears under **Weather Data Information**. To see the data in the file, click **View data**.



### Add/remove weather file folders

Use the folder settings to tell SAM what folders on your computer it should scan for weather files to build the solar resource library. SAM adds any files it can identify as valid weather files in each folder you specify to the library.

Before adding a file to the library, SAM checks the data in the file displays a message if it finds any problems with the data in the file.

SAM will only add valid weather files to the library. If you add a folder that contains CSV files that are not in the SAM CSV format, it will not add those files to the library.

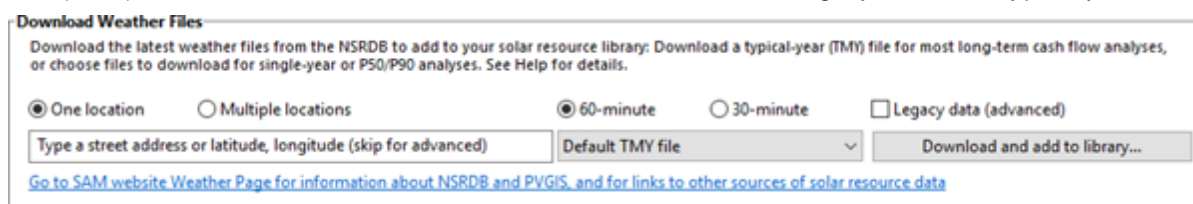
The list of solar resource folders are the folders that SAM scans for weather files to build the solar resource library.

### Refresh library

Refresh the library after adding files to the weather file folder. In most cases, SAM should automatically refresh the library as needed, but you may need to manually refresh it.

## Download Weather Files

SAM can download weather files from the latest National Solar Radiation Database (NSRDB) Physical Solar Model (PSM) datasets. For all NSRDB datasets, SAM can download single-year files or typical-year files.



**Note.** For locations not in the NSRDB, you can download EPW files from the European Commission Photovoltaic Geographical Information System [PVGIS V5 website](#) to a folder on your computer, and then use the [folder settings window](#) to add the folder to the list of folders SAM scans to build the solar resource library.

### To download a typical-year weather file for a single location:

1. Replace the text "Type a location name, street address or latitude and longitude" with a street address, city and state or country name, zip code, or latitude longitude pair. For example:



- Golden, Colorado
  - golden, co
  - 15013 Denver West Parkway, Golden CO 80401
  - 80401
  - thimpu, bhutan
2. Click **Download and add to library**.

For more instructions to download multiple files, see [Weather File Download Instructions](#) below.

SAM converts the address you type to a latitude and longitude pair for the location, and submits that information to the NSRDB along with your email address. If the location is in the region covered by the NSRDB, it returns a weather file in the SAM CSV format, and adds it to your weather file download folder. Otherwise, it displays a message telling you the location is not covered by the NSRDB.

When you first install SAM, it creates the *SAM Downloaded Weather Files* folder and assigns it as your weather file download folder. You can change the weather file download folder by clicking **Add/Remove weather file folders**. See [Folders and Libraries](#) for details.

When the download finishes, SAM displays a prompt asking you if you want to open the weather file download log. This prompt is the indication that the download finished. During the download and before that prompt appears, SAM may become unresponsive. If it does, wait for the prompt to avoid interrupting the download.

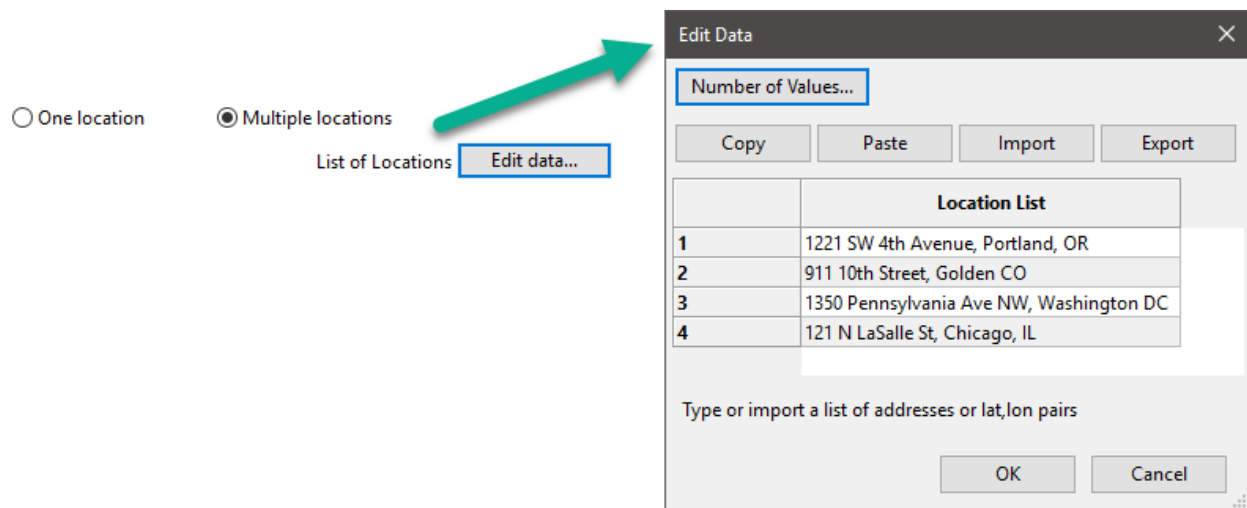
The weather file download log is a text file that SAM creates in your weather file download folder, and serves as a record of all of the files you download from the NSRDB. For each download, it lists the date and time of the request, the information you provided, the URL SAM generated, the name of the file returned by the NSRDB, or error messages it returns if the download fails. This information is useful for troubleshooting weather file download problems.

**Note.** Downloading multiple weather files from the NSRDB can take a long time. If you download files for multiple locations or years, be prepared to wait for the files to download. The download log file reports the time it takes for each file to download. Download times depend on your internet connection and computer. For a new computer with a fast connection, downloading and processing a single file takes about 10 seconds.

### One location, Multiple locations

Choose **One location** to download a weather file for a single location.

Choose **Multiple locations** to submit a list of locations and download a file or files for each location. For Multiple locations, click **Edit data** to open the Edit Data window where you can enter the list of locations and click **Number of Values** to enter the number of locations in the list.

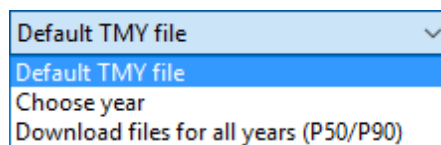


### 60-minute, 30-minute

Choose **60-minute** to download weather files with hourly time steps or 8,760 data records.

Choose **30-minute** to download files with 30-minute time steps or 17,520 data records. Thirty-minute data is not available for the NSRDB SUNY International dataset.

### Download options



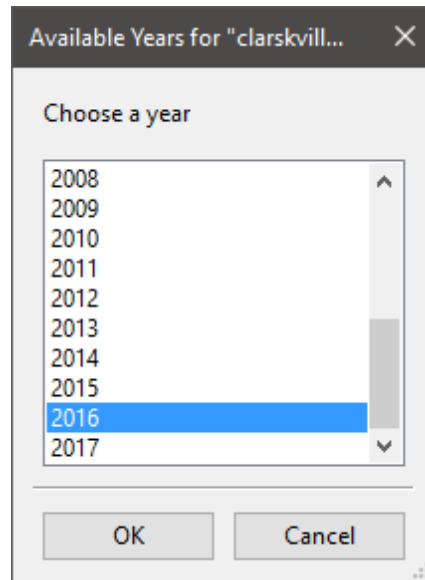
### Default TMY file

Download a typical meteorological year weather file for the location or locations you specified.

Typical year data is appropriate when you are using simulation results for a single year to make cash flow calculations over a multi-year period.

### Choose year

Choose a single year file to download. After you click the Download button, SAM prompts you with a list of available years for each location you requested to choose a year.



The single year option is appropriate when you want to see how the system would perform in a particular year. For example, for a residential or commercial system, if you have measured building load data for a given year, you could use weather data for the same year to see how the system's power output compares to the load.

If you use both **Choose year** and **Multiple locations**, SAM prompts you for a year for each location.

SAM queries the NSRDB to generate the list of available years. The list of available years varies between regions.

### Download files for all years (P50/P90)

Download a set of single-year files covering the range of historical data (nineteen files for 1998 through 2017 as of October 2018 for PSM data). When you click download, SAM creates a folder in your weather file download folder to store the single year files based on the location address or latitude-longitude pair you typed. It also downloads the typical meteorological year (TMY) file for the location and stores it in your weather file download folder.

SAM appends an underscore with the year to the file name so that the P50 P90 simulations work correctly. See [P50/P90 Simulations](#) for details.

If you choose to download files for all years with **Multiple locations**, SAM downloads a set of files for each location, and puts the files for each location in a separate folder. Note that this may take a long time.

## Weather File Download Instructions

### Examples of valid street address or latitude-longitude pairs:

- golden colorado
- golden, co
- 15013 Denver West Parkway, Golden CO 80401
- 80401
- 39.75, -105.15

- Super Market, F-6 Markaz, Islamabad, Pakistan
- New Delhi, India

**Note.** When the download finishes, SAM displays a prompt asking you if you want to open the weather file download log. This prompt is the indication that the download finished. During the download and before that prompt appears, SAM may become unresponsive. If it does, wait for the prompt to avoid interrupting the download.

**To download an hourly typical-year (TMY) weather file from the NSRDB (use this option for most situations):**

1. Click **One location**.
2. Type either a street address or latitude-longitude pair.
3. Click **60-minute**.
4. Choose **Default TMY File**.
5. Click **Download and add to library**.

**To download files for more than one location:**

1. Click **Multiple locations**.
2. Click **Edit data**.
3. In the Edit Data window, click **Number of Values** and type the number of locations to create a table with a row for each location.
4. Type a street address or latitude-longitude pair in the table for each location.
5. Click **OK**.
6. Choose a time step, **60-minute** for hourly, or **30-minute** for 30-minute data.
7. Choose the type of file(s) you want to download as described below.
8. Click **Download and add to library**.

## Weather Data Information

**Weather Data Information**

The following information describes the weather file selected from the Solar Resource library above. This is the file SAM will use when you click Simulate.

Weather file:  [View data](#)

**-Header Data from Weather File-**

City	<input type="text" value="-"/>	Station ID	<input type="text" value="91486"/>	Latitude	<input type="text" value="34.85 *N"/>
State	<input type="text" value="-"/>	Data Source	<input type="text" value="NSRDB"/>	Longitude	<input type="text" value="-116.78 *E"/>
Country	<input type="text" value="-"/>	Elevation	<input type="text" value="561 m"/>	Time zone	<input type="text" value="GMT -8"/>

**-Annual Averages Calculated from Weather File Data-**

Global horizontal	<input type="text" value="NaN"/>	kWh/m <sup>2</sup> /day	Average temperature	<input type="text" value="17.3"/>	°C
Direct normal (beam)	<input type="text" value="7.65"/>	kWh/m <sup>2</sup> /day	Average wind speed	<input type="text" value="2.4"/>	m/s
Diffuse horizontal	<input type="text" value="1.27"/>	kWh/m <sup>2</sup> /day	*NaN indicates missing data.		

**Weather file for simulation.**

**Information from weather file header.**

**Summary data calculated from time series data.**

### Weather File

The path and name of the active weather file SAM will use for simulation. Download a different file from the NSRDB, or click a different file name in the library to change the file.

### View data

Display weather file data in the [time series data viewer](#).

**Note.** You can also see the data after running a simulation on the Results page [data tables](#) and [time series graphs](#).

### Header Data from Weather File

Header data is information in the weather file that describes the location and type of data in the file. SAM uses the time zone, elevation, latitude and longitude to calculate the sun position during simulations. It does not use the city, state, country, and other descriptive information.

### Annual Values Calculated from Weather File

When you add a weather file to the solar resource library, SAM reads weather data from the file and calculates the annual values to display for your reference. It does not use annual values during simulations.

#### Global horizontal, Direct normal (beam), Diffuse horizontal

The sum of solar irradiance data (W/m<sup>2</sup>) in the weather file converted to kW and divided by 365 days/year.

#### Average temperature

The sum of temperature data (°C) in the weather file divided by the number of records in the file (8760 for hourly data).

#### Average wind speed

The sum of wind speed data (m/s) in the weather file divided by the number of records in the file (8760 for hourly data).

### Maximum snow depth

If the weather file contains snow depth data, the maximum value of snow depth data (cm) in the weather file. NaN indicates the file does not contain snow depth data. Snow depth data is required for to model snow losses for the Detailed Photovoltaic and PVWatts models.

**Note.** For information about where to find weather files with snow depth data, see the note on the [Weather Data](#) page of the SAM website.

### Annual albedo

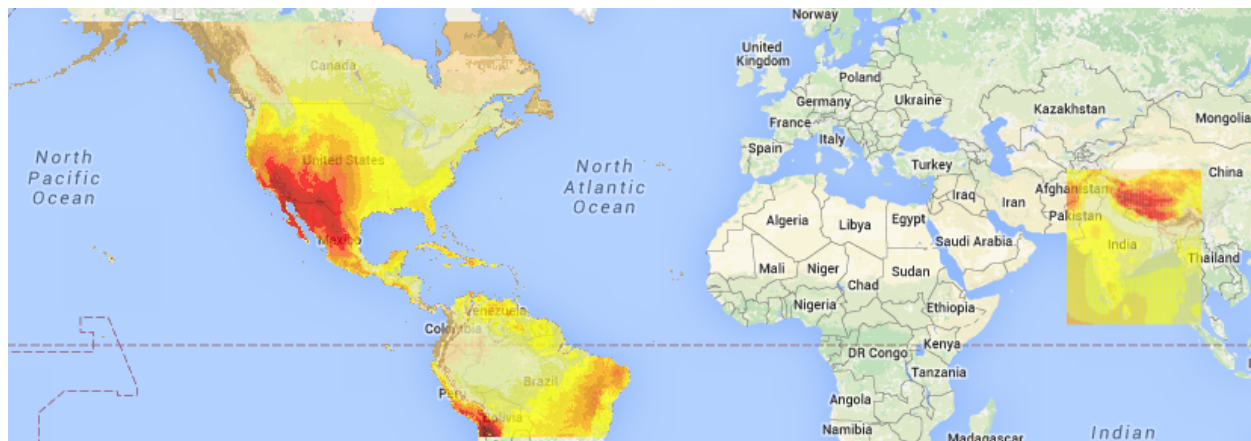
If the weather file contains albedo (ground reflectance) data, the average value of albedo values in the weather file. NaN indicates the file does not contain albedo data.

## ▼ About the NSRDB

The [NREL National Solar Radiation Database \(NSRDB\)](#) is an online database of weather files containing solar resource data in the [SAM CSV format](#). Files are available both as [typical-year](#) files and [single-year](#) files. The database covers the parts of the Americas and Asia shown in the map below. The current data is called PSM (Physical Solar Model) for the U.S., and SUNY for Asia. For details about the data see these pages on the NSRDB website:

- [U.S. data](#)
- [International data](#)

The NSRDB also contains legacy datasets for the U.S. from older versions of the NSRDB, including MTS3 (TMY3 1991-2010), MTS2 (TMY3 1991-2005), and MTS1 (TMY2 1961-1990). We recommend that you use the latest PSM data for your work in SAM, but the older data is available if you need it.



**Important Note for CSP Modelers!** SAM's CSP models assume that each DNI value in the weather file represents the average irradiance over the time step, and calculate sun angles for the midpoint of the time step. In weather files from the NSRDB, the irradiance data is measured instantaneously at either the beginning of the hour (TMY data), midpoint of the hour (single-year data), or beginning of the 30-minute time step (30-minute single-year data). As a result, if you use an NSRDB PSM weather file with a CSP model with either hourly TMY data or 30-minute single-year data, the sun angle for each time step will be for a different time than the time for the instantaneous irradiance values. See [Time Convention and Sun Position](#) for details.

**Notes.**

The NSRDB requires an email address to download weather file. When you download a weather file from SAM, SAM submits the email address that you used to [register SAM](#). NREL uses your email address to determine how many people are using the NSRDB. It does not share email addresses.

Different types of weather files in the NSRDB use different time conventions. See [Time Convention and Sun Position](#) for details.

When you download a file from the NSRDB website, SAM displays a "-" for the City, State, and Country fields because the NSRDB files do not contain that information. This will not affect simulation results. The location information SAM requires for simulations is latitude, longitude, elevation and time zone.

SAM uses the [Google Maps API Geocoding Service](#) service to identify the geographic coordinates (latitude and longitude) of a location when you type a street address or city and state name to identify the location.

For information about downloading weather files and data from other sources, see the [Weather Data](#) page on the SAM website.

SAM downloads weather files with the following hourly data from the NSRDB:

- Direct normal (beam) irradiance, DNI (W/m<sup>2</sup>)
- Diffuse horizontal irradiance, DHI (W/m<sup>2</sup>)
- Dry-bulb temperature (°C)
- Dew-point temperature (°C)
- Relative humidity (%), for single-year files only
- Atmospheric pressure (mbar)
- Wind speed at 2 meters above the ground (m/s)
- Wind direction (°E of N)
- Albedo

**Note.** Weather files with snow depth data for the Detailed Photovoltaic model are not available from the NSRDB PSM dataset. They are available for 239 locations in the United States from the legacy [MTS1 \(TMY2\) files in the original format](#), which cover the period 1961 - 1990. See [Snow Losses](#) for details.

## 20.2 System Costs

SAM uses the variables on the Linear Fresnel Costs page to calculate the project investment cost and annual operating costs reported in the project [cash flow](#) and used to calculate cost metrics reported in the Metrics table on the [Results page](#).

Because only the total installed cost value affects the cash flow calculations, you can assign capital costs to the different cost categories in whatever way makes sense for your analysis. For example, you could

assign the cost of designing the solar field to the solar field cost category or to the engineer-procure-construct category with equivalent results. The categories are provided to help you keep track of the different costs, but do not affect the economic calculations. After assigning costs to the categories, verify that the total installed costs value is what you expect.

Variable values in boxes with white backgrounds are values that you can edit. Boxes with blue backgrounds contain calculated values or values from other pages that SAM displays for your information.

#### **CSP System Cost Notes.**

The default cost values that appear when you create a file or case are intended to illustrate SAM's use. The cost data are meant to be realistic, but not to represent actual costs for a specific project. For more information and a list of online resources for cost data, see the [SAM website](#).

The direct capital costs in \$/kWe are in kilowatts of gross power block capacity rather than nameplate capacity because the size and cost of the power block is determined by the gross capacity, not the net capacity. The total installed cost in \$/kWe (actually overnight installed cost because it does not include financing during construction costs, which are accounted for on the [Financial Parameters](#) page) is in kilowatts of nameplate capacity, because that is what is delivered to the grid and is consistent with how costs are reported for utility generation technologies. The indirect costs in \$/Wac are in Watts of nameplate power block capacity because those costs that use the entire plant as the basis, not just the power block.

The System Costs page only available for cases with a cash-flow-based financial mode. It is not available with the No Financial Model option or the LCOE Calculator financial model.

## **Direct Capital Costs**

A direct capital cost represents an expense for a specific piece of equipment or installation service that applies in year zero of the cash flow.

**Note:** Because SAM uses only the total installed cost value in cash flow calculations, how you distribute costs among the different direct capital cost categories does not affect the final results.

### **Site Improvements (\$/m<sup>2</sup>)**

A cost per square meter of solar field area to account for expenses related to site preparation and other equipment not included in the solar field cost category.

### **Solar Field (\$/m<sup>2</sup>)**

A cost per square meter of solar field area to account for expenses related to installation of the solar field, including labor and equipment.

### **HTF System (\$/m<sup>2</sup>)**

A cost per square meter of solar field area to account for expenses related to installation of the heat transfer fluid pumps and piping, including labor and equipment.

### **Fossil Backup (\$/kWe)**

Cost per electric megawatt of power block gross capacity to account for the installation of a fossil backup system, including equipment and labor.



**Power Plant (\$/kWe)**

Cost per electric megawatt of power block gross capacity to account for the installation of the power block, including equipment and labor.

**Balance of Plant (\$/kWe)**

Cost per electric megawatt of power block gross capacity to account for additional costs.

**Contingency (%)**

A percentage of the sum of the site improvements, solar field, HTF system, storage, fossil backup, and power plant costs to account for expected uncertainties in direct cost estimates.

**Total Direct Cost (\$)**

The sum of improvements, solar field, HTF system, storage, fossil backup, power plant costs, and contingency costs.

**Indirect Capital Costs**

An indirect cost is typically one that cannot be identified with a specific piece of equipment or installation service.

**Note:** Because SAM uses only the total installed cost value in cash flow calculations, how you distribute costs among the different indirect capital cost categories does not affect the final results.

**Total Land Area**

The total land area required for the project, from the Solar Field or Heliostat Field page.

**Nameplate**

The system's nameplate capacity from the Power Block or Power Cycle page.

**EPC and Owner Cost**

EPC (engineer-procure-construct) and owner costs are associated with the design and construction of the project. SAM calculates the total cost as the sum of the Non-fixed Cost and Fixed Cost.

Typical costs that may be appropriate to include in the EPC and Owner category are: Permitting, royalty payments, consulting, management or legal fees, geotechnical and environmental surveys, interconnection costs, spare parts inventories, commissioning costs, and the owner's engineering and project development activities.

**Total Land Costs**

Costs associated with land purchases, which SAM calculates as the sum of a non-fixed cost and a fixed cost. Use the Land category described below for land costs, and inputs on the [Financial Parameters](#) page for financing costs.

SAM calculates the total EPC and Owner Costs and Total Land Costs by adding the four costs that you can specify using different units.

**\$/acre**

A cost in dollars per total land area in acres.

**% of direct cost**

A cost as a percentage of **Total Direct Cost** under **Direct Capital Cost**.

**\$/Wac**

A cost in dollars per AC Watt of nameplate capacity.

**\$**

A fixed dollar amount

**Sales Tax****Sales tax basis, %**

The percentage of total direct cost used to calculate sales tax amount.

SAM calculates the total sales tax amount by multiplying the sales tax rate from the [Financial Parameters](#) page by the sales tax basis on the System Costs page:

$$\text{Total Sales Tax (\$)} = \text{Sales Tax Rate (\%)} \times \text{Sales Tax Basis (\%)} \times \text{Total Direct Cost (\$)}$$

For an explanation of the effect of sales tax on income tax, see **Sales Tax** on the [Financial Parameters](#) topic for the financial model you are using (Residential, Commercial, Single Owner, etc.)

**Total Indirect Cost (\$)**

The sum of engineer-procure-construct costs, project-land-miscellaneous costs, and sales tax.

**Total Installed Cost**

The total installed cost is the sum of all of the direct and indirect capital costs that you specify. SAM uses this value to calculate the project's [net capital cost](#), which is the total installed cost less any cash incentives on the [Incentives](#) page and plus any additional financing costs from [Financial Parameters](#) page.

**Total installed cost (\$)**

The sum of total direct cost and total indirect cost.

**Total installed cost per capacity (\$/Wdc or \$/kW)**

Total installed cost divided by the total system rated or nameplate capacity. This value is provided for reference only. SAM does not use it in cash flow calculations.

**Operation and Maintenance Costs**

Operation and Maintenance (O&M) costs represent annual expenditures on equipment and services that occur after the system is installed. SAM allows you to enter O&M costs in three ways: Fixed annual, fixed by capacity, and variable by generation. O&M costs are reported on the project [cash flow](#).

For each O&M cost category, you can specify an optional annual **Escalation Rate** to represent an expected annual increase in O&M cost above the annual inflation rate specified on the [Financial Parameters](#). For an escalation rate of zero, the O&M cost in years two and later is the year one cost adjusted for inflation. For a non-zero escalation rate, the O&M cost in years two and later is the year one cost adjusted for inflation plus escalation.

For expenses such as component replacements that occur in particular years, you can use an annual schedule to assign costs to individual years. See below for details.

**Fixed Annual Cost (\$/yr)**

A fixed annual cost that applied to each year in the project cash flow.

**Fixed Cost by Capacity (\$/kW-yr)**

A fixed annual cost proportional to the system's rated or nameplate capacity.

### Variable Cost by Generation (\$/MWh)

A variable annual cost proportional to the system's total annual electrical output in AC megawatt-hours. The annual energy output depends on either the performance model's calculated first year value and the **degradation rate** from the [Lifetime](#) page, or on an annual schedule of costs, depending on the option chosen.

### Fossil Fuel Cost (\$/MMBtu)

The cost per million British thermal units for fuel. SAM uses the conversion factor 1 MWh = 3.413 MMBtu. SAM calculates a fossil fuel cost for concentrating solar power systems with fossil backup, and for the generic system when the heat rate on the [Power Plant](#) page is not zero.

**Note.** If you are using the [generic system](#) model to represent a system that does not consume fuel, you should use a fuel cost of zero.

## Entering Periodic Operation and Maintenance Costs

SAM allows you to specify any of the four operation and maintenance (O&M) cost categories on the System Costs page either as a single annual cost, or using a table of values to specify an annual schedule of costs. An annual schedule makes it possible to assign costs to particular years in the analysis period. Annual schedules can be used to account for component replacement costs and other periodic costs that do not recur on a regular annual basis.

You choose whether to specify an O&M cost as a single annual value or an annual schedule with the grey and blue button next to each variable. SAM uses the option indicated by the blue highlight on the button: A blue highlighted "Value" indicates a single, regularly occurring annual value. A blue highlighted "Sched" indicates that the value is specified as an annual schedule.

For example, to account for component replacement costs, you can specify the fixed annual cost category as an annual schedule, and assign the cost of replacing or rebuilding the component to particular years. For a 30-year project using a component with a seven-year life, you would assign a replacement cost to years seven, 14, and 21. Or, to account for expected improvements in the component's reliability in the future, you could assign component replacement costs in years seven, 17, and 27. After running a simulation, you can see the replacement costs in the project [cash flow](#) in the appropriate column under Operating Expenses. SAM accounts for the operating costs in the other economic metrics including the levelized cost of energy and net present value (NPV).

### Notes.

If you use the annual schedule option to specify equipment replacement costs, SAM does not calculate any residual or salvage value of system components based on the annual schedule. SAM calculates salvage value separately, using the salvage value you specify on the [Financial Parameters](#) page.

Dollar values in the annual schedule are in nominal or current dollars. SAM does not apply inflation and escalation rates to values in annual schedules.

The following procedure describes how to define the fixed annual cost category as an annual schedule. You can use the same procedure for any of the other operation and maintenance cost categories.

### To assign component replacement costs to particular years:

1. In the Fixed Annual Cost category, note that the "Value" label of the grey and blue button is blue indicating that the single value mode is active for the variable.

Fixed Annual Cost  \$/yr

In this case, SAM would assign an annual cost of \$284 to each year in the project cash flow.

- Click the button so that "Sched" label is highlighted in blue. SAM replaces the variable's value with an Edit button.

Edit...

- Click **Edit** to open the [Edit Schedule](#) window.
- In the Edit Schedule window, use the vertical scroll bar to find the year of the first replacement, and type the replacement cost in current or constant dollars for that year.  
To delete a value, select it and press the Delete key on your keyboard.

**Note.** You must type a value for each year. If you delete a value, SAM will clear the cell, and you must type a number in the cell or SAM will consider the schedule to be invalid. Type a zero for years with no annual costs.

- When you have finished editing the schedule, click **Accept**.

Because you must specify an O&M cost category as either an annual cost or annual schedule, to assign both a recurring annual fixed cost and periodic replacement cost, you must type the recurring cost in each year of the annual schedule, and for years with replacement costs, type the sum of the recurring and replacement costs.

## About the CSP Default Cost Assumptions

The default values the System Costs page for the CSP models reflect the National Renewable Energy Laboratory's best estimate of representative costs for CSP systems in the United States at the time of the release of the current version of SAM. The values are based on cost studies undertaken by NREL, review of published literature, and conversations with developers and industry insiders. Costs are reviewed prior to each new SAM release.

**Note.** Always review all of the inputs for your SAM project to determine whether they are appropriate for your analysis.

The parabolic trough and power tower system cost default values were largely developed from the following studies:

- Kurup, P.; Turchi, C. S. (2015). "Parabolic Trough Collector Cost Update for the System Advisor Model (SAM)," NREL/TP-6A20-65228, 2015. ([PDF 2.1 MB](#))
- Turchi, C. S.; Heath, G. A. (2013). "Molten Salt Power Tower Cost Model for the System Advisor Model (SAM)," NREL/TP-5500-57625, 2013. ([PDF 2.5 MB](#))
- Kolb, G. J.; Ho, C. K. (2011), T. R. Mancini, and J. A. Gary, "Power Tower Technology Roadmap and Cost Reduction Plan," SAND2011-2419. ([PDF 503 KB](#))
- Turchi, C. S. (2010). "Parabolic Trough Reference Plant for Cost Modeling with the Solar Advisor Model (SAM)," NREL/TP-550-47605. ([PDF 7.2 MB](#))

These studies differed in some important assumptions. The differences in the location and cooling method assumptions for the default cases of the CSP technologies are outlined in the following table. The choice of location affects solar resource and the assumed labor costs associated with the case. Construction labor rates in Arizona tend to be lower than in California, which reduces installed costs. For the Winter 2016 version of SAM, all CSP systems are assumed to use dry cooling. SAM can model systems with dry

cooling, wet cooling, or a hybrid of the two. If you change the type of cooling system on the Power Cycle input page, you should also change other parameters as appropriate because SAM does not make those changes automatically. For example, different types of cooling systems would require different power cycle costs and design-point performance parameters. Perhaps less obvious, the site preparation costs are lower for dry-cooled (air-cooled) systems than for wet-cooled (evaporative) systems because of the elimination of the large blowdown evaporation ponds required for wet systems.

Technology	Default Location	Default Cooling method
Physical Trough	SW Arizona (Tucson weather file)	Dry
Empirical Trough	SW Arizona (Tucson weather file)	Dry
Molten Salt Power Tower	Southern California (Daggett weather file)	Dry
Linear Fresnel	SW Arizona (Tucson weather file)	Dry
Generic Solar	SW Arizona (Tucson weather file)	Dry

The trough, tower, and linear Fresnel models assume the “balance of plant” cost category is composed of the steam generation system (Kolb, 2011). This choice is made to allow users to highlight the effect of a direct steam generation (DSG) design. In a DSG design, the balance of plant cost category is zero because steam generation occurs in the solar receiver.

The lesser commercial activity in linear Fresnel systems makes cost values for those technologies more uncertain than for troughs and towers. Linear Fresnel costs are estimated based on discussions with developers and researchers.

## 20.3 Direct Steam Linear Fresnel

The Direct Steam Linear Fresnel model predicts the performance of a direct-steam generation (DSG) plant that produces superheated steam at temperature and pressure settings that you specify. The model is designed to allow several technology configurations and characterization options that allow flexible and accurate performance analysis.

The solar field can be configured with an adjustable number of modules for the boiler and superheater sections, and the modules can use different geometry and optical performance input data depending on whether they are part of the boiler or superheater sections. The model allows you to specify whether the solar field uses a recirculated boiler or a once-through design. SAM models the steam mass flow rate, temperature, pressure, enthalpy, and quality throughout the field and uses this information to predict thermal losses, pressure drops, and transient effects for each hour of the year.

Several options are available for modeling the performance of the solar field. Collector optical performance can be specified using incidence angle modifier equations in the transversal and longitudinal directions, or an optical efficiency table can provide the optical efficiency as a function of either solar position or collector incidence angles. The Linear Fresnel model allows you to specify thermal loss relationships using either a set of polynomial equations or with a detailed evacuated tube receiver model.

The Linear Fresnel model represents all major subsystems associated with direct steam systems, including the solar field, optional auxiliary fossil backup system, the steam Rankine power cycle, heat rejection system, feedwater pumps, and plant control system. Output from the model includes financial

metrics as well as detailed performance data covering temperature, pressure, mass flow rates, thermal energy flow rates, water use, parasitic power consumption, turbine power output, and many other values.

The linear Fresnel model can also be used for compact linear Fresnel reflector (CLFR) systems by using the appropriate coefficients with the polynomial heat loss model for the receiver geometry and heat loss parameters on the Collector and Receiver page.

The direct steam linear Fresnel model is described in the following publications:

- Wagner, M.; Zhu, G. (2012). A Direct-steam Linear Fresnel Performance Model for NREL's System Advisor Model. NREL Conference Paper CP-5500-55044. ([PDF 647 KB](#))
- Wagner, M. (2012). Results and Comparison from the SAM Linear Fresnel Technology Performance Model: Preprint. NREL Conference Paper CP-5500-54758. ([PDF 726 KB](#))

## 20.3.1 Solar Field

### Solar Field Parameters

#### Option 1 and Option 2

For Option 1 (solar multiple mode), SAM calculates the total required aperture and number of loops based on the value you enter for the solar multiple.

For option 2 (field aperture mode), SAM calculates the solar multiple based on the field aperture value that you enter.

#### Solar Multiple

The field aperture area expressed as a multiple of the aperture area required to operate the power cycle at its design capacity.

**Note.** For a discussion of solar multiple and design-point conditions, see [Solar Multiple](#) section in the Parabolic Trough chapter.

#### Design point irradiation, W/m<sup>2</sup>

The design point direct normal radiation value, used in solar multiple mode to calculate the aperture area required to drive the power cycle at its design capacity. Also used to calculate the design mass flow rate of the heat transfer fluid for header pipe sizing.

#### Design point ambient temperature, °C

The reference ambient temperature for the solar field, used as a basis for calculating thermal losses from the receivers and piping. Note that this value is not used as a reference for receiver thermal losses if the evacuated tube receiver option is selected on the [Collector and Receiver](#) page.

#### Loop flow configuration

The loop flow configuration determines whether the boiler is configured as once-through or recirculated.

In the **recirculated boiler** design, a portion of the collectors in the loop are dedicated to boiling the subcooled feedwater, but the boiler mass flow rate is controlled such that the boiling mixture exits the boiler section with a vapor fraction (quality) equal to the value that you specify in the Boiler outlet steam quality input on the Solar Field page. The liquid fraction is extracted and recirculated to the inlet of the solar field loop where it mixes with the subcooled liquid from the power cycle outlet. The saturated

steam at the outlet of the boiler section does not recirculate, but instead passes into the dedicated superheater section where it continues to increase in temperature before entering the power cycle.

In the **once-through** design, subcooled feedwater from the power cycle outlet enters the solar field collector loop, is boiled to steam as it passes through the loop, and exits to the hot header as superheated steam.

The most common configuration for existing linear Fresnel plants is the recirculated boiler design, though developments in the technology show the once-through design to be promising. Both options are included in this model for comparative purposes.

### Superheater has unique geometry

SAM allows you to specify different geometries and optical characteristics for the boiler and superheater sections of the field.

To specify a field with different boiler and superheater geometries and optical characteristics, check the box, and specify the characteristics for each section on the [Collector and Receiver](#) page.

To specify a field with the same properties for the boiler and superheater sections, clear the check box, and specify characteristics for the boiler section only on the Collector and Receiver page. SAM will apply those properties to the entire field, and ignore the **Superheater Geometry** inputs on the Collector and Receiver page.

### Number of modules in boiler section

The number of boiler units in series in a single loop, each with geometry as defined on the [Collector and Receiver](#) page under **Boiler Geometry**.

### Number of modules in superheater section

The number of superheater units in series in a single loop, each with geometry as defined on the [Collector and Receiver](#) page under **Superheater Geometry**.

If **Superheater has unique geometry** is checked, the properties of the boiler section and superheater section will be different, as defined by the boiler and superheater inputs on the Collector and Receiver page. Otherwise, the boiler inputs to both the boiler and superheater sections.

**Note.** Take special care in selecting the number of boiler and superheater sections. The steam conditions at the outlet of the solar field depend on the ratio between the heat absorbed by the boiler and the superheater. As the heat absorbed in the superheater sections increases relative to the boiler sections, the outlet steam temperature will also increase beyond the design point. Consequently, the number of superheater modules should correspond to the desired thermal input in addition to the saturated steam produced by the boiler.

### Field pump efficiency

The isentropic efficiency of the feedwater and recirculation pump (if applicable) in the solar field. The total work required to propel the feedwater is divided by this efficiency value to give the electrical parasitic pumping requirement.

### Collector azimuth angle (degrees)

The azimuth angle of all collectors in the field, where zero degrees is pointing toward the equator, equivalent to a north-south axis. West is 90 degrees, and east is -90 degrees. SAM assumes that the collectors are oriented 90 degrees east of the azimuth angle in the morning and track the daily movement of the sun from east to west.

The collector azimuth angle variable is not active with the **Solar position table option** on the [Collector and Receiver](#) page. The variable is only active with either the two incidence angle options for specifying the solar field.

### **Thermal inertia per unit of solar field**

The amount of energy required to increase the working temperature of the solar field, per unit aperture area of the solar field. The thermal inertia term is used to model the startup and shutdown transient behavior of the solar field. During startup, the thermal energy produced by the solar field is reduced according to the energy that goes into heating the working fluid, receiver components, piping, fittings, and insulation. This input captures all of those aspects of transient startup in the solar field.

## **Steam Conditions at Design**

This set of inputs defines the design-point operating conditions of the steam in the solar field. The field inlet and outlet temperatures, the pressure constraints, and the boiler outlet quality (if applicable) are used to calculate the enthalpy of steam during the simulation at each collector module in the loop.

### **Field inlet temperature, °C**

The estimated temperature of feedwater from the power cycle at the inlet of the solar field. This value is used to calculate estimated thermal losses from the solar field at design, and is not directly used in calculating the hourly performance for the annual simulation. The field inlet temperature is calculated during performance runs based on the power cycle conversion efficiency and the steam temperature at the inlet of the power cycle.

### **Field outlet temperature, °C**

The estimated design-point steam outlet temperature from the solar field. The actual field outlet temperature is calculated in the performance runs based on the Loop flow configuration (once-through or recirculated boiler), the boiler outlet quality (for recirculated designs), collector performance, and flow rate constraints. The actual field outlet temperature during performance calculations is highly sensitive to the ratio of superheater to boiler aperture area, and consequently, the Field outlet temperature that you specify may differ substantially from the actual outlet temperature if care is not taken in selecting the correct number of superheater modules in the recirculated boiler design. Refer to the documentation on the number of boiler/superheater modules for more information.

### **Boiler outlet steam quality**

For the recirculated boiler configuration, the boiler outlet steam quality is used to calculate the mass flow rate of steam in the boiler section. This value represents the fraction of fluid exiting the boiler section that is in vapor phase. The balance of the unevaporated fluid recirculates to the inlet of the solar field and is mixed with the subcooled feedwater from the power cycle outlet.

This value is not used for the once-through Loop flow configuration.

### **Turbine inlet pressure**

The steam pressure at the inlet of the turbine at design conditions. The actual steam pressure during the performance calculations will vary as a function of the steam mass flow rate into the power cycle. The minimum steam pressure is limited to 50% of the design-point rating. Note that the steam mass flow rate into the power cycle may differ from the steam mass flow rate in the solar field if auxiliary fossil backup is used.

### **Cold header pressure drop fraction**

The fractional pressure drop across the cold header section of the solar field at design. The absolute pressure drop at design is equal to the fractional drop times the rated turbine inlet pressure.



**Boiler pressure drop fraction**

The fractional pressure drop across the boiler section of the solar field at design. The absolute pressure drop at design is equal to the fractional drop times the rated turbine inlet pressure.

**Pressure drop fraction between boiler and superheater**

The fractional pressure drop across any piping or steam separation equipment between the boiler and superheater sections at design. The absolute pressure drop at design is equal to the fractional drop times the rated turbine inlet pressure.

**Design point pressure drop across the superheater fraction**

The fractional pressure drop across the superheater section of the solar field at design. The absolute pressure drop at design is equal to the fractional drop times the rated turbine inlet pressure.

**Average design point hot header pressure drop fraction**

The fractional pressure drop across the hot header section of the solar field at design. The absolute pressure drop at design is equal to the fractional drop times the rated turbine inlet pressure.

**Total solar field pressure drop**

The total calculated solar field pressure drop at design. The calculated value is based on a sum of the fractional pressure drops from individual solar field subsystems and is multiplied by the rated turbine pressure at design.

$$\Delta P_{sf,design} = P_{turbine,des} \cdot (1 + F_{\Delta P,hdr,cold} + F_{\Delta P,boiler} + F_{\Delta P,separator} + F_{\Delta P,sh} + F_{\Delta P,hdr,hot})$$

Note that the pressure at the inlet of the solar field is equal to the pressure at the inlet of the turbine plus the total pressure drop across the solar field. You should choose a turbine design-point pressure to maintain operable steam pressures at the solar field inlet.

The steam property algorithms currently used in the SAM performance runs limit the maximum steam pressure to 190 bar, and values exceeding this limit will be reset during the simulation. This limit has been known to cause convergence issues in cases where design-point pressures are too high or where the solar field is designed to frequently operate with mass flow rates significantly higher than the design-point flow rate on which the pressure drop relationship is based.

**Design Point****Single loop aperture, m<sup>2</sup>**

This calculated value indicates the total reflective aperture area of the collectors in a single loop. The value is calculated by multiplying the number of nodes in the boiler and superheater sections by their corresponding reflective aperture area on the Collector and Receiver page. The total aperture area calculation is as follows:

$$A_{loop} = A_{module,boil} \cdot N_{module,boil} + A_{module,sh} \cdot N_{module,sh}$$

**Loop optical efficiency**

The total loop optical efficiency at design, where the solar position is normal to the collector aperture. The efficiency is the weighted product of the boiler and superheater sections, if applicable.

**Loop thermal efficiency**

The estimated thermal efficiency at design conditions corresponding to the input selections on the Collector and Receiver page. If the Polynomial fit heat loss model is

used, the polynomial equation for temperature-based heat loss is evaluated at the average design-point solar field temperature, where that temperature is equal to the average of the outlet and inlet solar field temperatures on the Solar Field page.

$$\overline{T}_{sf} = \frac{T_{field,out} - T_{field,in}}{2}$$

If the Evacuated tube heat loss model is used, SAM estimates thermal efficiency based on the user-specified Estimated avg. heat loss and Variant weighting fraction values on the Collector and Receiver page.

**Note.** The design-point thermal efficiency value is used only to size the solar field aperture area and is not part of the simulation calculations.

### Piping thermal efficiency

The estimated non-collector piping thermal efficiency at design. This value is calculated based on the Piping thermal loss coefficient on the Parasitics page. The estimated efficiency is equal to the compliment of the product of the average solar field operating temperature at design and the heat loss coefficient divided by the design-point solar irradiation.

$$\eta_{piping} = 1 - \frac{\overline{T}_{sf} \cdot F_{hl,coef}}{I_{bn,design}}$$

### Total loop conversion efficiency

The total estimated loop conversion efficiency at design, including collector optical performance, receiver thermal losses, and piping thermal losses. This value is used to size the solar field aperture area given a solar multiple and required power cycle thermal input.

### Total required aperture, SM=1

The calculated aperture area that provides a thermal output from the solar field that exactly matches the power cycle design-point thermal input (i.e. a solar multiple of 1). This value is used to calculate the corresponding number of loops at a solar multiple of 1.

### Required number of loops, SM=1

The number of loops that fulfills the thermal output requirement of the solar field at a solar multiple of 1.

### Actual number of loops

The number of loops in the solar field that produces a thermal output at design equal to the power cycle thermal input rating times the solar multiple.

### Actual aperture

The actual aperture area is a calculated value equal to the product of the actual number of loops and the reflective aperture area of a single loop, as calculated above.

### Actual solar multiple

The actual solar multiple is calculated using the thermal power produced at design with an aperture area equal to the Actual aperture calculated value, the design-point ambient and irradiation conditions, and the thermal power requirement of the power cycle.

The actual solar multiple may differ from the user-specified input value if the sum of the thermal output provided by the integer number of loops matches the product of the solar multiple (user input) and the power cycle thermal requirement.

### Field thermal output

Thermal energy output from the solar field at design conditions. This value is calculated based on the actual aperture area of the field and the estimated loop conversion efficiency at design.

$$\dot{Q}_{sf,design} = I_{bn,des} \cdot \eta_{loop,total} \cdot A_{sf,total} \cdot \frac{1 [MWt]}{1e6 [Wt]}$$

## Land Area

The land area inputs determine the total land area in acres that you can use to estimate land-related costs in \$/acres on the [System Costs](#) page. The land area inputs are inputs to the financial model, not the performance model, so they do not affect the performance model energy calculations.

### Solar field area, acres

The actual aperture area converted from square meters to acres:

$$\text{Solar Field Area (acres)} = \text{Actual Aperture (m}^2\text{)} \times \text{Row Spacing (m)} / \text{Maximum SCA Width (m)} \times 0.0002471 \text{ (acres/m}^2\text{)}$$

The maximum SCA width is the aperture width of SCA with the widest aperture in the field, as specified in the loop configuration and on the [Collectors \(SCA\)](#) page.

### Non-solar field land area multiplier

Land area required for the system excluding the solar field land area, expressed as a fraction of the solar field aperture area. A value of one would result in a total land area equal to the total aperture area.

### Total land area, acres

Land area required for the entire system including the solar field land area

$$\text{Total Land Area (acres)} = \text{Solar Field Area (acres)} \times (1 + \text{Non-Solar Field Land Area Multiplier})$$

The land area appears on the System Costs page, where you can specify land costs in dollars per acre.

## Mirror Washing

SAM reports the water usage of the system in the results based on the mirror washing variables. The annual water usage is the product of the water usage per wash and 365 (days per year) divided by the washing frequency.

### Water usage per wash

The volume of water in liters per square meter of solar field aperture area required for periodic mirror washing.

### Washes per year

The number of washes per year.

## Field Control

### Min single loop flow rate, kg/s

The minimum allowable steam flow rate in a single loop of the solar field. During night-time or low-insolation operation, the field will recirculate at a mass flow rate equal to this value. The minimum solar field mass flow rate is equal to the Min single loop flow rate times the actual number of loops in the field.

### Freeze protection temperature, °C

The temperature below which auxiliary fossil backup heat is supplied to the solar field to prevent water from freezing in the equipment. You should set this value such that a reasonable margin exists between activation of the electric heat trace freeze protection equipment and the actual freezing point of water.

### Stow wind speed, m/s

The maximum allowable wind velocity before the collectors defocus and enter safety stow position. The solar field cannot produce thermal energy during time steps in which the ambient wind velocity exceeds this limit.

### Solar elevation for collector nighttime stow, deg

The solar elevation angle (above the horizon) that sets the operational limit of the collector field in the evening hours. When the solar elevation angle falls below this value, the collector field will cease operation.

### Solar elevation for collector morning deploy, deg

The solar elevation angle (above the horizon) that sets the operational limit of the collector field in the morning hours. When the solar elevation angle rises above this value, the collector field will begin operation.

## 20.3.2 Collector and Receiver

The Collector and Receiver inputs describe the geometry and optical characteristics of the boiler and superheater sections of solar field. The field may consist of a boiler and superheater section with the same geometry and optical characteristics, or boiler and superheater sections with different geometries and optical characteristics.

If the boiler and superheater sections have different properties, check **Superheater has unique geometry** on the [Solar Field](#) page and specify inputs on the Collector and Receiver page under both **Boiler Geometry** and **Superheater Geometry**.

If the boiler and superheater sections have the same properties, clear **Superheater has unique geometry** check box on the Solar Field page, and specify inputs on the Collector and Receiver page under **Boiler Geometry** only. SAM will ignore the superheater geometry inputs.

## Linear Fresnel Geometries



Boiler Geometry



Superheater Geometry

## Boiler/Superheater Geometry and Optical Performance

### Reflective aperture area, m<sup>2</sup>

The total reflective aperture area for the module. This value is multiplied by the collector optical efficiency and the solar irradiance value to determine the total thermal energy incident on the module's receiver.

### Length of collector module, m

The length of a collector module along the receiver axis. This value is used to calculate thermal losses that are expressed in units of W/m.

### Tracking error

A fixed optical loss representing collector tracking error. This value multiplies the other fixed optical losses and the time-varying collector optical efficiency to determine the total optical efficiency.

### Geometry effects

A fixed optical loss representing collector geometry effects. This value multiplies the other fixed optical losses and the time-varying collector optical efficiency to determine the total optical efficiency.

### Mirror reflectivity

The optical loss fraction associated with mirror reflectivity, excluding soiling. This value multiplies the other fixed optical losses and the time-varying collector optical efficiency to determine the total optical efficiency.

### Mirror soiling

The optical loss fraction associated with soiling on the mirrors. This value multiplies the other fixed optical losses and the time-varying collector optical efficiency to determine the total optical efficiency.

### General optical error

Other optical loss not captured in the time-varying collector optical efficiency table/polynomials and fixed derates. This value multiplies the other fixed optical losses and the time-varying collector optical efficiency to determine the total optical efficiency.

## Optical characterization method

You can select one of three options for characterizing the optical performance of the solar field in addition to the fixed optical losses specified in the Collector Geometry and Optical Performance section. The three methods determine how the optical efficiency varies with sun position.

The optical efficiency is defined as follows:

$$\text{Optical Efficiency} = \frac{\text{Total Thermal Energy Absorbed by Receiver}}{\text{Direct Normal Irradiance} \times \text{Actual Aperture Area}}$$

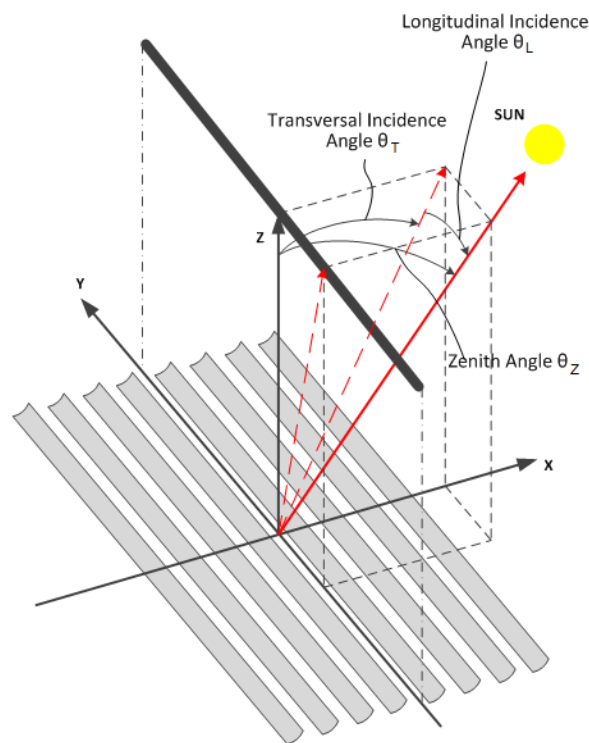
### Solar position table

The solar position table option allows you to specify optical efficiency of the solar field as a function of solar azimuth and zenith angles. SAM uses a solar azimuth angle convention where true North is equal to  $-180/+180^\circ$  and South equals  $0^\circ$ . The solar zenith angle is zero when the sun is directly overhead and  $90^\circ$  when the sun is at the horizon.

The solar position may contain any number of rows and columns, but should contain enough information to fully define the performance of the solar field at all sun positions for which the field will operate. The table must contain more than one row and column.

### Collector incidence angle table

The collector incidence angle table option allows you to specify solar field optical efficiency as a function of the longitudinal and transversal solar incidence angles. The collector incidence angles are defined as shown in the following figure, where the transversal incidence angle is given as  $\phi_T$  and the longitudinal incidence angle is  $\phi_L$ . The solar zenith angle is  $\theta_z$ .



### Incidence angle modifiers

The incidence angle modifier option allows you to specify optical performance of the solar field collectors using polynomial equations (up to fourth order) in both the transversal and longitudinal incidence angle directions. Refer to the Collector incidence angle table input documentation (above) for descriptions of the transversal ( $\phi_T$ ) and longitudinal ( $\phi_L$ ) collector angles.

## Solar Position/Collector Incidence Angle Table

### Import

Import a table from a text or data file. The file can contain values separated by comma, space, or tab characters, but must be formatted according to the following rules:

- The first row in the file specifies the angles for the solar azimuth (for the Solar position table) or collector transversal incidence (for the Collector incidence angle table). The first entry of this row should be blank.
- Each additional row specifies optical efficiency for a specific zenith angle (for the Solar position table) or longitudinal incidence angle (for the Collector incidence angle table). The first entry of the row must be the zenith or longitudinal incidence angle corresponding to the optical efficiency entries in that row.
- The rows of the table should be sorted according to zenith/longitudinal incidence angle from lowest to highest.

An example tab-delimited table is as follows, where numbers in bold correspond to the solar zenith (row headers) and azimuth (column headers) angles:

	<b>-180</b>	<b>90</b>	<b>0</b>	<b>90</b>	<b>180</b>
<b>0</b>	1.0	1.0	1.0	1.0	1.0
<b>30</b>	0.95	0.98	0.99	0.98	0.95
<b>60</b>	0.60	0.70	0.75	0.70	0.60
<b>90</b>	0.0	0.0	0.0	0.0	0.0

Note that SAM automatically sizes the table on the Collector and Receiver page to match the size of the array that is being imported.

### Export

Export the optical efficiency table on the Collector and Receiver page to a text file.

### Copy

Copy the optical efficiency table on the Collector and Receiver page to the clipboard for transfer to an optical efficiency table in another case or to other text applications.

### Paste

Paste an optical efficiency table from another SAM case or from a text file into the active case.

### Rows

Specify the number of desired rows in the table.

### Cols

Specify the number of desired columns in the table.

## Incidence Angle Modifier Coefficients

This option allows you to specify the optical performance of the collector field as functions of the transversal and longitudinal incidence angles where the performance is expressed in polynomial form.

### Transverse incidence angle modifier

The incidence angle modifier polynomial for the transversal incidence angle, as defined in the documentation for the collector incidence angle table (above). The polynomial to calculate the optical efficiency reduction associated with deviation of the irradiation incidence angle in the transversal plane is as follows:

$$IAM_T = C_0 + C_1 \cdot \phi_T + C_2 \cdot \phi_T^2 + C_3 \cdot \phi_T^3 + C_4 \cdot \phi_T^4$$

where  $\phi_T$  is the transversal incidence angle.

**Longitudinal incidence angle modifier**

The incidence angle modifier polynomial for the longitudinal incidence angle, as defined in the documentation for the collector incidence angle table (above). The polynomial to calculate the optical efficiency reduction associated with deviation of the irradiation incidence angle in the longitudinal plane is as follows:

$$IAM_L = C_0 + C_1 \cdot \phi_L + C_2 \cdot \phi_L^2 + C_3 \cdot \phi_L^3 + C_4 \cdot \phi_L^4$$

where  $\phi_L$  is the longitudinal incidence angle.

**Receiver Geometry and Heat Loss****Polynomial heat loss model/Evacuated tube model**

You can specify the thermal losses from the solar field receiver components using one of two approaches: the first approach allows general specification of thermal losses using polynomial equations. The polynomials provide heat loss as a function of steam temperature with a correction based on wind velocity, and heat loss is evaluated at each collector module in the loop. The second option allows the use of a detailed evacuated tube receiver model. Select the model using the dropdown menu in this section.

**Polynomial fit heat loss model****Steam temperature adjustment**

This polynomial gives thermal losses in the solar field receiver component as a function of the difference between steam temperature and ambient dry-bulb temperature in degrees Celsius. Thermal losses are evaluated at each collector module in the loop using the following expression for the coefficient of heat loss [W/m]:

$$F_{hl}(T) = C_0 + C_1 \cdot \Delta T_{local} + C_2 \cdot \Delta T_{local}^2 + C_3 \cdot \Delta T_{local}^3 + C_4 \cdot \Delta T_{local}^4$$

where  $\Delta T_{local}$  is the local (to the module) difference between the steam temperature and ambient dry bulb temperature.

**Wind velocity adjustment**

SAM allows you to adjust the thermal loss coefficient calculated from the Steam temperature adjustment polynomial ( $F_{hl}(T)$ ). The resulting value from the wind velocity polynomial multiplies the steam temperature heat loss polynomial, as follows:

$$F_{hl}(V_{wind}) = C_0 + C_1 \cdot V_{wind} + C_2 \cdot V_{wind}^2 + C_3 \cdot V_{wind}^3 + C_4 \cdot V_{wind}^4$$

$$F_{hl,total} = F_{hl}(T) \cdot F_{hl}(V_{wind})$$

**Evacuated tube heat loss model****Absorber tube inner diameter (m)**

Inner diameter of the receiver absorber tube, this surface in direct contact with the heat transfer fluid.

**Absorber tube outer diameter (m)**

Outer diameter of the receiver absorber tube, the surface exposed to the annular vacuum.

**Glass envelope inner diameter (m)**

Inner diameter of the receiver glass envelope tube, the surface exposed to the annular vacuum.

**Glass envelope outer diameter (m)**

Outer diameter of the receiver glass envelope tube, the surface exposed to ambient air.



**Absorber flow plug diameter (m)**

A non-zero value represents the diameter of an optional plug running axially and concentrically within the receiver absorber tube. A zero value represents a receiver with no plug. The plug allows for an increase in the receiver absorber diameter while maintaining the optimal heat transfer within the tube heat transfer fluid. For a non-zero value, be sure to use annular flow for the absorber flow pattern option.

**Internal surface roughness**

The surface roughness of the inner receiver pipe surface exposed to the heat transfer fluid, used to determine flow shear force and the corresponding pressure drop across the receiver.

Surface roughness is important in determining the scale of the pressure drop throughout the system. As a general rule, the rougher the surface, the higher the pressure drop (and parasitic pumping power load). The surface roughness is a function of the material and manufacturing method used for the piping. A conservative roughness value for extruded steel pipe (the type often used for the absorber pipe) is about  $3\text{e-}6$  meters. The default value of  $4.5\text{e-}5$  m is based on this value and the absorber tube inner diameter value of 0.066 m:  $3\text{e-}6 \text{ m} / 6.6\text{e-}2 \text{ m} = 4.5\text{e-}5$ .

**Absorber flow pattern (m)**

Use standard tube flow when the absorber flow plug diameter is zero. Use annular flow with a non-zero absorber flow plug diameter.

**Absorber material type**

The material used for the absorber tube. Choose from stainless steel or copper.

**Variant weighting fraction**

The fraction of the solar field that consists of the active receiver variation. For each receiver type, the sum of the four variations should equal one. You can use the receiver variations to model a solar field with receivers in different conditions. If you want all of the receivers in the field to be identical, then you can use a single variation and assign it a variant weighting fraction of 1.

When you use more than one receiver variation, be sure that the sum of the four variant weighting fractions is 1.

Here's an example of an application of the receiver variations for a field that consists of a two receiver types. The first type, Type 1, represents receivers originally installed in the field. Type 2 represents replacement receivers installed as a fraction of the original receivers are damaged over time.

Over the life of the project, on average, 5 percent of the Type 1 receivers have broken glass envelopes, and another 5 percent have lost vacuum in the annulus. We'll also assume that degraded receivers are randomly distributed throughout the field -- SAM does not have a mechanism for specifying specific locations of different variations of a given receiver type. To specify this situation, we would start with Type 1, and use Variation 1 to represent the 90 percent of intact receivers, assigning it a variant weighting fraction of 0.90. We'll use Variation 2 for the 5 percent of receivers with broken glass envelopes, giving it a weighting fraction of 0.05, and Variation 3 for the other 5 percent of lost-vacuum receivers with a weighting fraction of 0.05. We'll assign appropriate values to the parameters for each of the two damaged receiver variations.

Next, we'll specify Type 2 to represent intact replacement receivers. We will use a single variation for the intact Type 2 receivers.

On the Solar Field page, we'll specify the single loop configuration (assuming a loop with eight assemblies), using Type 2 for the first and second assembly in the loop, and Type 1 receivers (with the variant weighting we assigned on the Receivers page) for the remaining six assemblies in the loop

**Absorber absorptance**

The ratio of radiation absorbed by the absorber to the radiation incident on the absorber.

**Absorber emittance**

The energy radiated by the absorber surface as a function of the absorber's temperature. You can either specify a table of emittance and temperature values, or specify a single value that applies at all temperatures.

**Envelope absorptance**

The ratio of radiation absorbed by the envelope to the radiation incident on the envelope, or radiation that is neither transmitted through nor reflected from the envelope. Used to calculate the glass temperature. (Does not affect the amount of radiation that reaches the absorber tube.)

**Envelope emittance**

The energy radiated by the envelope surface.

**Envelope transmittance**

The ratio of the radiation transmitted through the glass envelope to the radiation incident on the envelope, or radiation that is neither reflected nor refracted away from the absorber tube.

**Broken glass**

Option to specify that the envelope glass has been broken or removed, indicating that the absorber tube is directly exposed to the ambient air.

**Annulus gas type**

Gas type present in the annulus vacuum. Choose from Hydrogen, air, or Argon.

**Annulus pressure (torr)**

Absolute pressure of the gas in the annulus vacuum, in torr, where 1 torr = 133.32 Pa

**Estimated avg. heat loss (W/m)**

An estimated value representing the total heat loss from the receiver under design conditions. SAM uses the value to calculate the total loop conversion efficiency and required solar field aperture area for the design point values on the [Solar Field page](#). It does not use the value in simulation calculations.

**Bellows shadowing**

An optical derate factor accounting for the fraction of radiation lost after striking the mechanical bellows at the ends of the receiver tubes.

**Dirt on receiver**

An optical derate factor accounting for the fraction of radiation lost due to dirt and soiling on the receiver.

**Aggregate Weighted Losses****Average field temp difference at design**

The effective temperature for thermal loss estimates, equal to the average solar field temperature. This temperature is used to evaluate thermal losses from the solar field receivers (polynomial heat loss model only) and from piping as specified on the Parasitics page. This value is calculated as the average of the Field inlet temperature and Field outlet temperature on the Solar Field page.

**Heat loss at design**

Calculated estimate of thermal losses at the Average field temp difference at design. In the case of the polynomial heat loss model, the estimate is calculated based on the difference between the average temperature and the design-point ambient temperature from the Solar Field page. In the case of the evacuated tube receiver model, the estimate is based on the user-specified Estimated avg. heat loss values on the Collector and Receiver page.

**Receiver thermal derate**

Calculated value indicating the estimated thermal efficiency of the solar field receivers. This value is calculated based on the Heat loss at design calculated value, and is used only to size the solar field aperture area. Note that this value is not used in annual hourly performance calculations.

**Receiver optical derate**

The reduction in optical efficiency associated with envelope transmittance and receiver soiling. This derate is calculated as a weighted sum for the four receiver variants and only applies to the evacuated receiver model option.

**Collector optical loss at normal incidence**

The optical efficiency from the optical table or incident angle modifier polynomials at normal solar incidence.

### 20.3.3 Power Cycle

The power cycle converts thermal energy to electric energy. The power cycle is assumed to consist of a superheated two-stage turbine with multiple extractions for feedwater heating and a reheat extraction between the high and low pressure turbine stages. You specify the design-point efficiency of this cycle on the Power Cycle page, and SAM models the part-load behavior with normalized performance curves as a function of steam inlet temperature, mass flow rate, and ambient temperature. The ambient temperature correction uses the wet-bulb temperature for wet-cooled systems and hybrid systems and the dry-bulb temperature for dry cooled and hybrid cooled systems.

The power cycle page displays variables that specify the design operating conditions for the steam Rankine cycle used to convert thermal energy to electricity.

## Plant Design

**Design turbine gross output, MWe**

The power cycle's design output, not accounting for parasitic losses.

**Estimated gross to net conversion factor**

An estimate of the ratio of the electric energy delivered to the grid to the power cycle's gross output. SAM uses the factor to calculate the power cycle's nameplate capacity for capacity-related calculations, including the estimated total cost per net capacity value on the System Costs page, and the capacity factor reported in the results.

**Net nameplate capacity, MWe**

The power cycle's nameplate capacity, calculated as the product of the design gross output and estimated gross to net conversion factor.

$$\text{Net Nameplate Capacity (MWe)} = \text{Design Gross Output (MWe)} \times \text{Estimated Gross to Net Conversion Factor}$$

**Rated cycle efficiency**

The thermal to electric conversion efficiency of the power cycle under design conditions.

**Design thermal input power, MWt**

The turbine's design thermal input. It is the thermal energy required at the power block inlet for it to operate at its design point, as defined by the value of the nameplate electric capacity and an estimate of the parasitic losses: Design thermal power = nameplate electric capacity + total parasitic loss estimate. (See the Parasitics page for a description of the total parasitic loss estimate.)

**High pressure turbine inlet pressure, bar**

The inlet pressure of the high pressure turbine at design. This is one of the values necessary to define the cycle at design. Current steam properties are limited to 190 bar, so this pressure should be set lower than 190 bar so that the property calculations do not fail at higher pressures calculated upstream of the turbine. The simulation may stop or produce warnings if the property routing encounters pressures greater than 190 bar.

**High pressure turbine outlet pressure, bar**

The outlet pressure of the high pressure turbine at design. This is another value necessary to define the cycle at design.

**Design reheat mass flow rate fraction**

The fraction of steam mass flow rate that exits the high pressure turbine and enters the reheater. The remaining flow is transferred to the feedwater heaters for use in preheating.

**Fossil backup boiler LHV efficiency**

The auxiliary fossil backup boiler's lower heating value efficiency, used to calculate the quantity of natural gas required by the boiler.

If your system includes an auxiliary boiler, choose a fossil dispatch mode and define the fossil fill fractions as described below.

**Steam cycle blowdown fraction**

The fraction of the steam mass flow rate in the power cycle that is extracted and replaced by fresh water. This fraction is multiplied by the steam mass flow rate in the power cycle for each hour of plant operation to determine the total required quantity of power cycle makeup water. The blowdown fraction accounts for water use related directly to replacement of the steam working fluid. The default value of 0.013 for the wet-cooled case represents makeup due to blowdown quench and steam cycle makeup during operation and startup. A value of 0.016 is appropriate for dry-cooled systems to account for additional wet-surface air cooling for critical Rankine cycle components.

**Plant Cooling Mode****Condenser type**

Choose either an air-cooled condenser (dry cooling), evaporative cooling (wet cooling), or hybrid cooling system.

In hybrid cooling a wet-cooling system and dry-cooling share the heat rejection load. Although there are many possible theoretical configurations of hybrid cooling systems, SAM only allows a parallel cooling option.

**Ambient temp at design, °C**

The ambient temperature at which the power cycle operates at its design-point-rated cycle conversion efficiency. For the air-cooled condenser option, use a dry bulb ambient temperature value. For the evaporative condenser, use the wet bulb temperature.

**Reference Condenser Water dT, °C**

For the evaporative type only. The temperature rise of the cooling water across the condenser under design conditions, used to calculate the cooling water mass flow rate at design, and the steam condensing temperature.

**Approach temperature, °C**

For the evaporative type only. The temperature difference between the circulating water at the condenser inlet and the wet bulb ambient temperature, used with the ref. condenser water dT value to determine the condenser saturation temperature and thus the turbine back pressure.

**ITD at design point, °C**

For the air-cooled type only. Initial temperature difference (ITD), difference between the temperature of steam at the turbine outlet (condenser inlet) and the ambient dry-bulb temperature.

**Note.** When you adjust the ITD, you are telling the model the conditions under which the system will achieve the thermal efficiency that you've specified. If you increase the ITD, you should also modify the thermal efficiency (and/or the design ambient temperature) to accurately describe the design-point behavior of the system. The off-design penalty in the modified system will follow once the parameters are corrected.

**Condenser pressure ratio**

For the air-cooled type only. The pressure-drop ratio across the air-cooled condenser heat exchanger, used to calculate the pressure drop across the condenser and the corresponding parasitic power required to maintain the air flow rate.

**Minimum condenser pressure, inHg**

The minimum condenser pressure in inches of mercury prevents the condenser pressure from dropping below the level you specify. In a physical system, allowing the pressure to drop below a certain point can result in physical damage to the system. For evaporative (wet cooling), the default value is 1.25 inches of mercury. For air-cooled (dry cooling), the default is 2 inches of mercury. For hybrid systems, you can use the dry-cooling value of 2 inches of mercury.

**Cooling system part load levels**

The cooling system part load levels tells the heat rejection system model how many discrete operating points there are. A value of 2 means that the system can run at either 100% or 50% rejection. A value of three means rejection operating points of 100% 66% 33%. The part load levels determine how the heat rejection operates under part load conditions when the heat load is less than full load. The default value is 2, and recommended range is between 2 and 10. The value must be an integer.

**Operation****Low resource standby period, hr**

During periods of insufficient flow from the heat source due to low thermal resource, the power block may enter standby mode. In standby mode, the cycle can restart quickly without the startup period

required by a cold start. The standby period is the maximum number of hours allowed for standby mode. This option is only available for systems with thermal storage. Default is 2 hours.

**Fraction of thermal power needed for standby**

The fraction of the turbine's design thermal input required from storage to keep the power cycle in standby mode. This thermal energy is not converted into electric power. Default is 0.2.

**Startup time, hr**

The time in hours that the system consumes energy at the startup fraction before it begins producing electricity. If the startup fraction is zero, the system will operate at the design capacity over the startup time. Default is 0.5 hours.

**Fraction of thermal power needed for startup**

The fraction of the turbine's design thermal input required by the system during startup. This thermal energy is not converted to electric power. Default is 0.75.

**Minimum operation fraction**

The fraction of the nameplate electric capacity below which the power block does not generate electricity. Whenever the power block output is below the minimum load and thermal energy is available from the solar field, the field is defocused. For systems with storage, solar field energy is delivered to storage until storage is full. Default is 0.25.

**Max over design operation fraction**

The maximum allowable power block output as a fraction of the electric nameplate capacity. Whenever storage is not available and the solar resource exceeds the design value of 950 W/m<sup>2</sup>, some heliostats in the solar field are defocused to limit the power block output to the maximum load. Default is 1.05.

**Fossil dispatch mode**

The fossil dispatch mode determines how the optional auxiliary fossil (natural gas) backup boiler is configured and how it operates. Use the **fossil fill fraction** input under **Dispatch Control** to determine when the auxiliary boiler operates. Use the fossil backup boiler LHV efficiency value under Plant Design to define the boiler's lower heating value efficiency.

If your system has an auxiliary fossil backup boiler, and you want to account for fuel costs in the financial model, you should assign a fossil fuel cost under Operation and Maintenance costs on the [System Costs](#) page.

**Note.** If the **Fossil fill fraction** under **Dispatch Control** is zero for all periods, the system does not include an auxiliary fossil backup boiler, and you can ignore the fossil dispatch mode input.

**Minimum backup level**

In the Minimum Backup Level mode, the auxiliary boiler is in parallel with the power cycle and supplies heat to steam at the power cycle inlet when the solar field thermal output falls below the level defined by the fossil fill fractions and weekday/weekend schedules.

For example, for an hour with a fossil fill fraction of 1.0 when solar energy delivered to the power cycle is less than that the design thermal input power, the auxiliary boiler would supply enough energy to "fill" the missing heat so that the thermal power at the power cycle inlet is at the design point. If, in that scenario, solar energy from the field is driving the power cycle at full load, the auxiliary boiler would not operate. For a fossil fill fraction of 0.75, the auxiliary boiler would only be fired when solar output drops below 75% of the power cycle's design thermal input power.

### Supplemental operation

In the Supplemental Operation mode, the auxiliary boiler is in parallel with the power cycle and supplies sufficient heat to the steam at the power cycle inlet for the power cycle to operate at its design point, where the design point is determined by the fossil fill fractions and weekday/weekend schedules.

Operation of the power cycle in a given hour is constrained by the **Max turbine over design operation fraction** and **Minimum operation fraction**. For hours that the energy added by the auxiliary backup boiler is insufficient to meet the minimum requirement, the backup boiler is not dispatched.

### Topping mode

In the Topping mode, the auxiliary boiler is in series with the power cycle, and supplies heat to the steam as it enters the power cycle whenever the steam temperature at the solar field outlet is less than the design field outlet temperature defined on the [Solar Field](#) page. In topping mode, the auxiliary backup boiler does not operate at night.

For the topping mode option, ignore the fossil fill fraction inputs. The auxiliary boiler will operate based on the field outlet steam temperature rather than based on the fossil fill fractions.

### Hybrid Cooling Dispatch

When you choose Hybrid as the condenser type, the hybrid dispatch table specifies how much of the cooling load should be handled by the wet-cooling system for each of 6 periods in the year. The periods are specified in the matrices at the bottom of the [Thermal Storage](#) page. Each value in the table is a fraction of the design cooling load. For example, if you want 60% of heat rejection load to go to wet cooling in Period 1, type 0.6 for Period 1. Directing part of the heat rejection load to the wet cooling system reduces the total condenser temperature and improves performance, but increases the water requirement. SAM sizes the wet-cooling system to match the maximum fraction that you specify in the hybrid dispatch table, and sizes the air-cooling system to meet the full cooling load.

## System Availability

System availability losses are reductions in the system's output due to operational requirements such as maintenance down time or other situations that prevent the system from operating as designed.

**Note.** To model curtailment, or forced outages or reduction in power output required by the grid operator, use the inputs on the [Grid Limits](#) page.

To edit the system availability losses, click **Edit losses**.

The [Edit Losses](#) window allows you to define loss factors as follows:

- Constant loss is a single loss factor that applies to the system's entire output. You can use this to model an availability factor.
- Hourly losses apply to specific hours of the year.

SAM reduces the system's output in each hour by the loss percentage that you specify for that hour. For a given hour, a loss of zero would result in no adjustment. A loss of 5% would reduce the output by 5%, and a loss of -5% would increase the output value by 5%. For subhourly simulations, SAM applies the loss factor for a given hour to each time step in that hour

## Dispatch Control

The dispatch control periods determine the following:

- For a plant with hybrid cooling, the timing of wet-cooling fractions when the plant cooling mode **Condenser type** is **Hybrid**.
- For a plant with an auxiliary fossil backup boiler, the timing and level of the backup boiler.

**Notes.** If your analysis involves PPA price multipliers defined on the [Revenue](#) page, you should verify that the dispatch control schedules are consistent with the TOD factor schedules.

### Hybrid cooling fraction

For each period defined in the weekday and weekend schedules, specify how much of the cooling load should be handled by the wet-cooling system.

Each value in the table is a fraction of the design cooling load. For example, if you want 60% of heat rejection load to go to wet cooling in Period 1, type 0.6 for Period 1. Directing part of the heat rejection load to the wet cooling system reduces the total condenser temperature and improves performance, but increases the water requirement. SAM sizes the wet-cooling system to match the maximum fraction that you specify in the hybrid dispatch table, and sizes the air-cooling system to meet the full cooling load.

### Fossil fill fraction

The fossil fill fraction and weekday/weekend schedules determine when and at what power level the auxiliary fossil backup boiler operates.

**Note.** If you choose the **topping mode** option for the fossil dispatch mode, the fossil fill fraction does not affect the operation of the auxiliary backup boiler, so you can ignore these inputs.

To model a system with no backup boiler, set the fossil fill fraction for all periods to zero.

To model a system with an auxiliary fossil backup boiler, first choose a **fossil dispatch mode** input under **Operation** to define the boiler's configuration. Then, define the dispatch schedules as described below, and set the fossil fill fraction for each period that you want the backup boiler to operate. A fossil fill fraction of 1 is equivalent to 100% of the design thermal input power. A fossil fill fraction of zero is equivalent to no fossil backup. For example, if you specify a fossil fill fraction of 0.3 for Period 1, the auxiliary boiler will supply heat to the steam at the power cycle inlet to up to 30% of the power cycle design thermal input power during Period 1.

If your system has an auxiliary fossil backup boiler, and you want to account for fuel costs in the financial model, you should assign a fossil fuel cost under Operation and Maintenance costs on the [System Costs](#) page.

## Defining Dispatch Schedules

The storage dispatch schedules determine when each of the nine periods apply during weekdays and weekends throughout the year.

If your analysis includes [PPA price multipliers](#) and you want to use the same schedule for the multipliers and for the power cycle dispatch control, click **Copy schedule from TOD Factors** page to apply the TOD Factors schedule matrices to the dispatch schedule matrices.

### To specify a weekday or weekend schedule:

1. Assign values as appropriate to the **Hybrid Cooling** and **Fossil Fill** fractions for each of the up to nine periods.
2. Use your mouse to draw a rectangle in the matrix for the first block of time that applies to period 2.



	12am	1am	2am	3am	4am	5am	6am	7am	8am	9am	10am	11am	12pm	1pm	2pm	3pm	4pm	5pm	6pm	7pm	8pm	9pm	10pm	11pm
Jan	1	1	1	1	1	1	1	1	1	1	1	1	1	1	1	1	1	1	1	1	1	1	1	1
Feb	1	1	1	1	1	1	1	1	1	1	1	1	1	1	1	1	1	1	1	1	1	1	1	1
Mar	1	1	1	1	1	1	1	1	1	1	1	1	1	1	1	1	1	1	1	1	1	1	1	1
Apr	1	1	1	1	1	1	1	1	1	1	1	1	1	1	1	1	1	1	1	1	1	1	1	1
May	1	1	1	1	1	1	1	1	1	1	1	1	1	1	1	1	1	1	1	1	1	1	1	1
Jun	1	1	1	1	1	1	1	1	1	1	1	1	1	1	1	1	1	1	1	1	1	1	1	1
Jul	1	1	1	1	1	1	1	1	1	1	1	1	1	1	1	1	1	1	1	1	1	1	1	1
Aug	1	1	1	1	1	1	1	1	1	1	1	1	1	1	1	1	1	1	1	1	1	1	1	1
Sep	1	1	1	1	1	1	1	1	1	1	1	1	1	1	1	1	1	1	1	1	1	1	1	1
Oct	1	1	1	1	1	1	1	1	1	1	1	1	1	1	1	1	1	1	1	1	1	1	1	1
Nov	1	1	1	1	1	1	1	1	1	1	1	1	1	1	1	1	1	1	1	1	1	1	1	1
Dec	1	1	1	1	1	1	1	1	1	1	1	1	1	1	1	1	1	1	1	1	1	1	1	1

3. Type the number 2.

	12am	1am	2am	3am	4am	5am	6am	7am	8am	9am	10am	11am	12pm	1pm	2pm	3pm	4pm	5pm	6pm	7pm	8pm	9pm	10pm	11pm
Jan	1	1	1	1	1	1	1	1	1	1	1	1	1	1	1	1	1	1	1	1	1	1	1	1
Feb	1	1	1	1	1	1	1	1	1	1	1	1	1	1	1	1	1	1	1	1	1	1	1	1
Mar	1	1	1	1	1	1	1	1	1	1	1	1	1	1	1	1	1	1	1	1	1	1	1	1
Apr	1	1	1	1	1	1	1	1	1	1	1	1	1	1	1	1	1	1	1	1	1	1	1	1
May	1	1	1	1	1	1	1	1	1	1	2	2	2	2	2	2	1	1	1	1	1	1	1	1
Jun	1	1	1	1	1	1	1	1	1	1	2	2	2	2	2	2	1	1	1	1	1	1	1	1
Jul	1	1	1	1	1	1	1	1	1	1	2	2	2	2	2	2	1	1	1	1	1	1	1	1
Aug	1	1	1	1	1	1	1	1	1	1	2	2	2	2	2	2	1	1	1	1	1	1	1	1
Sep	1	1	1	1	1	1	1	1	1	1	1	1	1	1	1	1	1	1	1	1	1	1	1	1
Oct	1	1	1	1	1	1	1	1	1	1	1	1	1	1	1	1	1	1	1	1	1	1	1	1
Nov	1	1	1	1	1	1	1	1	1	1	1	1	1	1	1	1	1	1	1	1	1	1	1	1
Dec	1	1	1	1	1	1	1	1	1	1	1	1	1	1	1	1	1	1	1	1	1	1	1	1

4. SAM shades displays the period number in the squares that make up the rectangle, and shades the rectangle to match the color of the period.

**Dispatch Control**

[Copy schedule from TOD Factors page](#)

Use the schedule matrices to specify the month and hour of day for each of the nine periods.

Turbine output fraction

Period 1:

Period 2:

Period 3:

Period 4:

Period 5:

Period 6:

Period 7:

Period 8:

Period 9:

The turbine output fraction scales the turbine thermal input relative to design for the corresponding time-of-use period.

**Weekday Schedule**

	12am	1am	2am	3am	4am	5am	6am	7am	8am	9am	10am	11am	12pm	1pm	2pm	3pm	4pm	5pm	6pm	7pm	8pm	9pm	10pm	11pm
Jan	1	1	1	1	1	1	1	1	1	1	1	1	1	1	1	1	1	1	1	1	1	1	1	1
Feb	1	1	1	1	1	1	1	1	1	1	1	1	1	1	1	1	1	1	1	1	1	1	1	1
Mar	1	1	1	1	1	1	1	1	1	1	1	1	1	1	1	1	1	1	1	1	1	1	1	1
Apr	1	1	1	1	1	1	1	1	1	1	1	1	1	1	1	1	1	1	1	1	1	1	1	1
May	1	1	1	1	1	1	1	1	1	1	2	2	2	2	2	2	1	1	1	1	1	1	1	1
Jun	1	1	1	1	1	1	1	1	1	1	2	2	2	2	2	2	1	1	1	1	1	1	1	1
Jul	1	1	1	1	1	1	1	1	1	1	2	2	2	2	2	2	1	1	1	1	1	1	1	1
Aug	1	1	1	1	1	1	1	1	1	1	2	2	2	2	2	2	1	1	1	1	1	1	1	1
Sep	1	1	1	1	1	1	1	1	1	1	1	1	1	1	1	1	1	1	1	1	1	1	1	1
Oct	1	1	1	1	1	1	1	1	1	1	1	1	1	1	1	1	1	1	1	1	1	1	1	1
Nov	1	1	1	1	1	1	1	1	1	1	1	1	1	1	1	1	1	1	1	1	1	1	1	1
Dec	1	1	1	1	1	1	1	1	1	1	1	1	1	1	1	1	1	1	1	1	1	1	1	1

5. Repeat Steps 2-4 for each of the remaining periods that apply to the schedule.

## 20.3.4 Parasitics

The parasitic loss variables are factors that SAM uses to calculate the estimated total parasitic loss and hourly parasitic losses, which are described in more detail below.

SAM calculates two types parasitic loss values. The first is an estimate of the total parasitic losses used to calculate the power cycle design thermal input, and the second are the hourly values calculated during simulation of the system's performance.

**Note.** Parasitic losses from components that do not exist in the system should be set to zero.

### Parasitic Energy Consumption

#### Piping thermal loss coefficient (W/K-m<sup>2</sup>-aper)

Thermal loss per area of collector aperture as calculated on the [Solar Field](#) page.

#### Tracking Power (W/m<sup>2</sup>)

The electric power in Watts per area of collector aperture required by the tracking mechanism of each collector in the field during hours of operation.

#### Tracking Power Loss (W)

SAM calculates the power loss in Watts based on the W/m<sup>2</sup> value you specify above.

#### Fraction of rated gross power consumed at all times

The fraction of design-point gross power output from the power cycle that is used for parasitics associated with facility operation, HVAC, control, lighting, etc.

#### Fixed parasitic loss (MWe)

SAM calculates the fixed loss based on the fraction you specify above.

#### Balance of Plant Parasitic (MWe/MWcap)

Losses as a fraction of the power cycle electrical power output that apply in hours when the power block operates.

#### Aux heater, boiler parasitic (MWe/MWcap)

Parasitic power consumption incurred during operation of the backup fossil boiler, as a function of thermal power production of the fossil system. This parasitic is only applicable for systems with active fossil backup, and applies during hours in which the fossil system produces thermal power.

## 20.4 Molten Salt Linear Fresnel

The molten salt linear Fresnel model simulates the performance of a linear Fresnel system that utilizes a sensible-heating liquid such as molten salt as the heat transfer fluid (HTF) in the field. This model complements the [direct steam linear Fresnel](#) model for linear Fresnel systems that utilize water/steam as the heat transfer fluid.

The molten salt linear Fresnel model includes a thermal energy storage model, which may use either the same HTF as the solar field, or a different fluid. If the field and storage system use the same HTF, the system is modeled as a direct storage system with no heat exchanger between the field and storage system. If the field and storage fluids differ, SAM includes a heat exchanger in the storage system that impacts exergetic system performance. SAM always assumes a heat exchanger between the liquid HTF and the steam flow in the power cycle.

Several options are available for modeling the performance of the solar field. Collector optical performance can be specified using incidence angle modifier equations in the transversal and longitudinal directions, or an optical efficiency table can provide the optical efficiency as a function of either solar position or collector incidence angles. The linear Fresnel model allows you to specify thermal loss relationships either using a set of polynomial equations or with a detailed evacuated tube receiver model.

The molten salt linear Fresnel model represents all major subsystems associated with indirect systems, including the solar field, optional thermal energy storage system, optional auxiliary fossil backup system, steam Rankine power cycle, heat rejection system, feedwater pumps, and plant control system. Output from the model includes financial metrics as well as detailed performance data covering temperature, pressure, mass flow, thermal energy flow, water use, parasitic consumption, turbine power output, and many other relevant values.

The molten salt linear Fresnel model can also be used for compact linear Fresnel reflector (CLFR) systems by using the appropriate coefficients with the polynomial heat loss model for the receiver geometry and heat loss parameters on the Collector and Receiver page.

### 20.4.1 Solar Field

#### Solar Field Parameters

##### Option 1 and Option 2

For Option 1 (solar multiple mode), SAM calculates the total required aperture and number of loops based on the value you enter for the solar multiple. For option 2 (field aperture mode), SAM calculates the solar multiple based on the field aperture value you enter. Note that SAM does not use the value that appears dimmed for the inactive option. See [Solar Multiple](#) for details.

##### Solar Multiple

The field aperture area expressed as a multiple of the aperture area required to operate the power cycle at its design capacity. See [Solar Multiple](#) for details.

##### Field aperture, m<sup>2</sup>

The total solar energy collection area of the solar field in square meters. Note that this is less than the total mirror surface area.

**Irradiation at design, W/m<sup>2</sup>**

The design point direct normal radiation value, used in solar multiple mode to calculate the aperture area required to drive the power cycle at its design capacity. Also used to calculate the design mass flow rate of the heat transfer fluid for header pipe sizing. See Sizing the Solar Field for details.

**Design point ambient temperature, °C**

The reference ambient temperature for the solar field, used as a basis for calculating thermal losses from the receivers and piping. Note that this value is not used as a reference for receiver thermal losses if the evacuated tube receiver option is selected on the Collector and Receiver page.

**Design point wind velocity, m/s**

The wind velocity at which receiver heat loss performance is evaluated for the design point (if applicable). This value is used to calculate receiver thermal loss at design when the Polynomial heat loss model is used on the Collector and Receiver page under the Receiver Geometry and Heat Loss group.

**HTF pump efficiency**

The isentropic efficiency of the heat transfer fluid pump in the solar field. The total work required to propel the HTF is divided by this efficiency value to give the electrical parasitic pumping requirement.

**Header pipe roughness, m**

Average surface roughness of the header piping. The pipe roughness is used to calculate pressure loss through the piping system during the time-series simulation.

**Stow angle, degrees**

The solar elevation angle (above the horizon) that sets the operational limit of the collector field in the evening hours. When the solar elevation angle falls below this value, the collector field will cease operation.

**Deploy angle, degrees**

The solar elevation angle (above the horizon) that sets the operational limit of the collector field in the morning hours. When the solar elevation angle rises above this value, the collector field will begin operation.

**Freeze point heat trace activation temperature, °C**

The solar field temperature below which auxiliary fossil backup heat is supplied to the solar field to prevent water from freezing in the equipment. You should set this value such that a reasonable margin exists between activation of the electric heat trace freeze protection equipment and the actual freezing point of water.

**Initial field temperature, °C**

The initialization temperature of all simulation nodes in the solar field for the first time step of the simulation. This value does not typically impact the annual productivity of the plant, but it can be important in obtaining convergence in the first time step of the year.

**Allow partial defocusing**

Partial defocusing assumes that the tracking control system can adjust the collector angle in response to the capacity of the power cycle (and thermal storage system, if applicable).

**Defocusing strategy**

During hours when the solar field delivers more thermal energy than the power cycle (and thermal storage system, if available) can accept, or when the mass flow rate is higher than the maximum header design flow rate, SAM defocuses collectors to reduce the solar field thermal output. Mathematically, the

model multiplies the radiation incident on the collector by a defocusing factor. In a physical system, the collector tracker would adjust the collector angle to reduce the amount of absorbed energy.

SAM provides three defocusing options:

- Option 1. No partial defocusing allowed: Collectors are either oriented toward the sun or in stow position. Collectors defocus in the order you specify. You should define a defocusing order as described below for this option.
- Option 2. Partial defocusing allowed with **sequenced** defocusing: Collectors can partially defocus by making slight adjustments in the tracking angle.
- Option 3. Partial defocusing allowed with **simultaneous** defocusing: Collectors can partially defocus by making slight adjustments in the tracking angle. All of the collectors in the field defocus by the same amount at the same time.

## Plant Heat Capacity

### Heat capacity of the balance of plant on the hot side, kWh/K-MWt

The thermal inertia of the hot header to account for any thermal inertia not accounted for in the HTF volume calculations: Thermal energy in kilowatt-hours per gross electricity capacity in megawatts needed to raise the hot side temperature one degree Celsius. The default value is 0.2 kWh/K-MWt.

### Heat capacity of the balance of plant on the cold side, kWh/K-MWt

The thermal inertia of the cold header to account for any thermal inertia not accounted for in the HTF volume calculations: Thermal energy in kilowatt-hours per gross electricity capacity in megawatts needed to raise the hot side temperature one degree Celsius. The default value is 0.2 kWh/K-MWt.

### Non-HTF heat capacity associated with each SCA, Wh/K-m

The thermal inertia of piping, joints, insulation, and other SCA components: The amount of thermal energy per meter of SCA length required to raise the temperature of piping, connectors, insulation, and other SCA components one degree K. The default value is 4.5 Wh/K-m.

### HTF volume in single collector unit, L/m<sup>2</sup>-ap

The quantity of HTF contained in the solar field per square meter of aperture area. This value is used to calculate the internal energy of the HTF in the solar field during the time series simulation. You can calculate this value by considering the piping (or other) internal volume in the solar field transport system and dividing by the total reflector aperture area.

Note that this volume is used for both the Polynomial heat loss model and the Evacuated Tube Receiver model.

## Land Area

The land area inputs determine the total land area in acres that you can use to estimate land-related costs in \$/acres on the [System Costs](#) page. The land area inputs are inputs to the financial model, not the performance model, so they do not affect the performance model energy calculations.

### Solar field area, acres

The actual aperture area converted from square meters to acres:

$$\text{Solar Field Area (acres)} = \text{Actual Aperture (m}^2\text{)} \times \text{Row Spacing (m)} / \text{Maximum SCA Width (m)} \times 0.0002471 \text{ (acres/m}^2\text{)}$$

The maximum SCA width is the aperture width of SCA with the widest aperture in the field, as specified

in the loop configuration and on the [Collectors \(SCA\)](#) page.

#### Non-solar field land area multiplier

Land area required for the system excluding the solar field land area, expressed as a fraction of the solar field aperture area. A value of one would result in a total land area equal to the total aperture area.

#### Total land area, acres

Land area required for the entire system including the solar field land area

$$\text{Total Land Area (acres)} = \text{Solar Field Area (acres)} \times (1 + \text{Non-Solar Field Land Area Multiplier})$$

The land area appears on the System Costs page, where you can specify land costs in dollars per acre.

## Heat Transfer Fluid

#### Field HTF fluid

The heat transfer fluid (HTF) used in the heat collection elements and headers of the solar field. SAM includes the following options in the HTF library: Solar salt, Caloria, Hitec XL, Therminol VP-1, Hitec salt, Dowtherm Q, Dowtherm RP, Therminol 59, and Therminol 66. You can also define your own HTF using the user-defined HTF fluid option.

**Note.** During the simulation, SAM counts the number of instances that the HTF temperature falls outside of the operating temperature limits in the table below. If the number of instances exceeds 50, it displays a simulation [notice](#) with the HTF temperature and time step number for the 50th instance.

If you define a custom fluid, SAM disables the minimum and maximum operating temperature variables and displays zero because it does not have information about the operating limits for the fluid you defined. You can check the time series temperature data in the results to ensure that they do not exceed the limits for your custom fluid.

**Heat transfer fluids on the Field HTF Fluid list.**

Name	Type	Min Optimal Operating Temp °C	Max Optimal Operating Temp* °C	Freeze Point °C	Comments
Hitec Solar Salt	Nitrate Salt	238	593	238	
Hitec	Nitrate Salt	142	538	142	
Hitec XL	Nitrate Salt	120	500	120	
Caloria HT 43	Mineral Hydrocarbon	-12	315	-12 (pour point)	used in first Luz trough plant, SEGS I
Therminol VP-1	Mixture of Biphenyl and Diphenyl Oxide	12	400	12 (crystallization point)	Standard for current generation oil HTF systems
Therminol 59	Synthetic HTF	-45	315	-68 (pour point)	
Therminol 66	?	0	345	-25 (pour point)	
Dowtherm Q	Synthetic Oil	-35	330	n/a	
Dowtherm RP	Synthetic Oil	n/a	330	n/a	

\*The maximum optimal operating temperature is the value reported as "maximum bulk temperature" on the product data sheets.

**Data Sources for HTF Properties**

Hitec fluids: Raade J, Padowitz D, Vaughn J. [Low Melting Point Molten Salt Heat Transfer Fluid with Reduced Cost](#). Halotechnics. Presented at SolarPaces 2011 in Granada, Spain.

Caloria HT 43: [Product comparison tool](#) on Duratherm website.

Therminol Fluids: Solutia [Technical Bulletins](#) 7239115C, 7239271A, 7239146D.

Dowtherm Fluids: Dow [Data Sheet](#) for Q, no data sheet available for RP (high temp is from website): <http://www.dow.com/heattrans/products/synthetic/dowtherm.htm>.

**User-defined solar field HTF fluid**

To define your own HTF, choose User-defined for the Field HTF fluid and specify a table of material properties for use in the solar field. You must specify at least two data points for each property: temperature, specific heat, density, viscosity, and conductivity. See [Custom HTF](#) for details.

**Field HTF min operating temp, °C**

The minimum HTF operating temperature recommended by the HTF manufacturer.

In some cases the minimum operating temperature may be the same as the fluid's freeze point. However, at the freeze point the fluid is typically significantly more viscous than at design operation temperatures, so it is likely that the "optimal" minimum operating temperature is higher than the freeze point.

**Field HTF max operating temp, °C**

The minimum HTF operating temperature recommended by the HTF manufacturer.

Operation at temperatures above this value may result in degradation of the HTF and be unsafe. To avoid this, you may want to include a safety margin and use a maximum operating temperature value slightly lower than the recommended value.

**Notes.**

SAM displays the operating temperature limits for your reference so you can compare them to the field temperatures reported in the results to ensure that they do not exceed the limits. SAM does not adjust the system's performance to avoid exceeding these operating limits.

SAM only displays these limits for fluids that are in SAM's library. If you use a custom HTF instead of one from the SAM library, SAM disables the HTF operating temperature limits. In this case, you should use data from the fluid manufacturer specifications.

**Design loop inlet temp, °C**

The temperature of HTF at the loop inlet under design conditions. The actual temperature during operation may differ from this value. SAM sets the power cycle's design outlet temperature equal to this value.

**Target loop outlet temp, °C**

The temperature of the HTF at the outlet of the loop under design conditions. During operation, the actual value may differ from this set point. This value represents the target temperature for control of the HTF flow through the solar field and will be maintained when possible.

**Min single loop flow rate, kg/s**

The minimum allowable flow rate through a single loop in the field.

During time steps that produce a solar field flow rate that falls below the minimum value, the HTF temperature leaving the solar field will be reduced in temperature according to the heat added and minimum mass flow rate.

**Max single loop flow rate, kg/s**

The maximum allowable flow rate through a single loop in the field.

During time steps that produce a solar field flow rate that exceeds the maximum value, the solar field will be defocused according to the strategy selected by the user on the Solar Field page until the absorbed energy and corresponding mass flow rate fall below the maximum value.

**Min field flow velocity, m/s**

The minimum allowable HTF flow velocity through the field.

**Max field flow velocity, m/s**

The maximum allowable HTF flow velocity through the field.

The minimum and maximum solar field HTF flow velocity depend on the minimum and maximum HTF mass flow rates, HTF density at the design loop inlet temperature, and the absorber tube inner diameter specified on the Receivers page. SAM calculates the field HTF flow velocity for the receiver type with the smallest diameter.

**Variable Name****Equation****Notes**



Min field flow velocity	$= \frac{\dot{m}_{loop,min} * 4}{\rho_{HTF,in} * \pi * D_{tube,min}^2}$	Evaluate rho at SF inlet temp Minimum tube diameter is for tube diameters from whole loop
Max field flow velocity	$= \frac{\dot{m}_{loop,max} * 4}{\rho_{HTF,out} * \pi * D_{tube,min}^2}$	Evaluate rho at SF outlet temp

**Header design min flow velocity, m/s**

The minimum allowable HTF flow velocity in the header piping under design conditions.

**Header design max flow velocity, m/s**

The maximum allowable HTF flow velocity in the header piping under design conditions. The minimum/maximum header flow velocities are used to determine the diameter of the header piping as flow is diverted to each loop in the field. After flow is distributed (or collected) to/from the loops, System Advisor calculates the flow velocity and resizes the piping to correspond to the maximum velocity if the calculated value falls outside of the user-specified range.

**Design Point**

The design point variables show values at the Irradiation at Design Value that SAM uses to determine the system capacity in sizing calculations, and for area-based costs on the [System Costs](#) page.

For a description of the equations for the design point variables, see See [Equations for Calculated Values](#).

**Single loop aperture (m<sup>2</sup>)**

The aperture area of a single loop of collectors, equal to the product of aperture width, reflective area, times the structure length times the number of collector assemblies per loop according to the distribution of the up to four collector types in the field. This area does not include non-reflective surface on the collector or non-reflective space between collectors.

*Single Loop Aperture (m<sup>2</sup>) = Sum of the SCA Reflective Aperture Area (m<sup>2</sup>) values for each SCA in the loop*

The SCA reflective aperture area for each SCA type is specified on the [Collector and Receiver](#) page.

**Loop optical efficiency**

The optical efficiency when incident radiation is normal to the aperture plane, not including end losses or cosine losses. This value does not include thermal losses from piping and the receivers.

*Loop Optical Efficiency = Collector Optical Efficiency at Design × Receiver Optical Derate*

The receiver and collector optical efficiency values are from the [Collector and Receiver](#) page.

**Total loop conversion efficiency**

The total conversion efficiency of the loop, including optical losses and estimated thermal losses. Used to calculate the required aperture area of the solar field.

**Total required aperture, SM=1, m<sup>2</sup>**

The exact mirror aperture area required to meet the design thermal output for a solar multiple of 1.0. SAM uses the required aperture to calculate the total aperture reflective area. The total aperture reflective area may be slightly more or less than the required aperture, depending on the collector dimensions you specify on the [Collectors](#) page.

**Required number of loops, SM=1**

The exact number of loops required to produce the total required aperture at a solar multiple of 1.0. This number may be a non-integer value, SAM rounds this value to the nearest integer to calculate the value of the actual number of loops variable.

**Actual number of loops**

The actual number of loops in the field, equal to the solar multiple times the required number of loops at a solar multiple of 1.0. The required number of loops is rounded to the nearest integer to represent a realistic field layout.

**Total aperture reflective area, m<sup>2</sup>**

The actual aperture area based on the actual number of loops in the field, equal to the single loop aperture times the actual number of loops.

**Actual solar multiple**

For Option 1 (solar multiple mode), the calculated solar multiple based on the actual (rounded) number of loops in the field. For Option 2 (field aperture mode), the solar multiple value corresponding to the thermal output of the field based at design point: The total aperture reflective area divided by the field thermal output.

**Field thermal output (MWt)**

The thermal energy delivered by the solar field under design conditions at the actual solar multiple.

**Equations for Calculated Values**

The following table shows the equations SAM uses to calculate the values for the variables above that you cannot edit. (In Windows, the calculated values appear in blue.)

Variable Name	Equation	Notes
Single loop aperture	$= \sum_{i=0}^{N_{SCA}} A_{SCA,i}$	Sum of aperture area of each individual collector in the loop
Loop optical efficiency	= Aggregate Collector Efficiency * Aggregate Receiver Optical Efficiency	Efficiencies are calculated elsewhere
Total loop conversion efficiency	= Loop Optical Efficiency * Receiver Heat Loss Efficiency	$\eta_{loop,tot}$ used in Total Required Aperture equation
Total required aperture, SM=1	$= \frac{W_{des,gross}}{\eta_{des} * DNI_{des} * \eta_{loop,tot}} * 1e6$	$A_{sf,SM1}$ used in Required Number of Loops equation
Required number of loops, SM=1	$= \frac{A_{sf,SM1}}{A_{loop}}$	
Actual number of loops	$round \left[ SM * \frac{A_{sf,tot}}{A_{loop}} \right]$ $round \left[ \frac{A_{sf,tot}}{A_{loop}} \right]$	Equation depends on solar field option: Option 1 uses the solar multiple value that you specify, Option 2 uses the field aperture area that you specify.
Total aperture reflective area	$= A_{loop} * N_{loop,actual}$	

Actual solar multiple	$\frac{SM}{\frac{A_{sf,tot}}{A_{sf,SM1}}}$	Equation depends on solar field option: Option 1 is the solar multiple value that you specify, Option 2 is the ratio.
Field thermal output	$= SM * \frac{W_{des,gross}}{\eta_{pb,des}}$	pb = power block
Solar field area	$= A_{sf,tot} * \frac{L_{row\ spacing}}{\max[W_{SCA,i}]} * 0.0002471$	$W_{SCA,i}$ is the aperture width of each collector $i$ in the loop
Total land area	= Solar field area * Non-Solar field land area multiplier	

## Mirror Washing

SAM reports the water usage of the system in the results based on the mirror washing variables. The annual water usage is the product of the water usage per wash and 365 (days per year) divided by the washing frequency.

### Water usage per wash

The volume of water in liters per square meter of solar field aperture area required for periodic mirror washing.

### Washes per year

The number of washes in one year.

## 20.4.2 Collector and Receiver

### Collector Geometry and Optical Performance

#### Reflective aperture area of the collector, m<sup>2</sup>

The total reflective aperture area for the module. This value is multiplied by the collector optical efficiency and the solar irradiance value to determine the total thermal energy incident on the module's receiver.

#### Length of collector module, m

The length of a collector module along the receiver axis. This value is used to calculate thermal losses that are expressed in units of W/m.

#### Length of crossover piping in a loop, m

The length of piping used to connect collector rows in a loop (if applicable). This piping contributes to thermal inertia and thermal loss effects.

#### Piping distance between sequential modules, m

The length of non-flux-absorbing piping between modules in a collector row. This piping contributes to thermal inertia and thermal loss effects.

**Collector azimuth angle, degrees**

The angle between the primary axis of the Linear Fresnel collector system and the North-South axis. If the collector system is rotated clockwise, the Collector azimuth angle is positive. If the collector system is rotated counterclockwise, the angle is negative.

**Tracking error derate**

A fixed optical loss representing collector tracking error. This value multiplies the other fixed optical losses and the time-varying collector optical efficiency to determine the total optical efficiency.

**Geometry effects derate**

A fixed optical loss representing collector geometry effects. This value multiplies the other fixed optical losses and the time-varying collector optical efficiency to determine the total optical efficiency.

**Solar-weighted mirror reflectivity**

The optical loss fraction associated with mirror reflectivity, excluding soiling. This value multiplies the other fixed optical losses and the time-varying collector optical efficiency to determine the total optical efficiency.

**Dirt on mirror derate**

The optical loss fraction associated with soiling on the mirrors. This value multiplies the other fixed optical losses and the time-varying collector optical efficiency to determine the total optical efficiency.

**General optical derate**

Other optical loss not captured in the time-varying collector optical efficiency table/polynomials and fixed derates. This value multiplies the other fixed optical losses and the time-varying collector optical efficiency to determine the total optical efficiency.

**Optical characterization method**

You can select one of three options for characterizing the optical performance of the solar field in addition to the fixed optical losses specified in the Collector Geometry and Optical Performance section. The three methods determine how the optical efficiency varies with sun position.

The optical efficiency is defined as follows:

$$\text{Optical Efficiency} = \frac{\text{Total Thermal Energy Absorbed by Receiver}}{(\text{Direct Normal Irradiance} \times \text{Actual Aperture Area})}$$

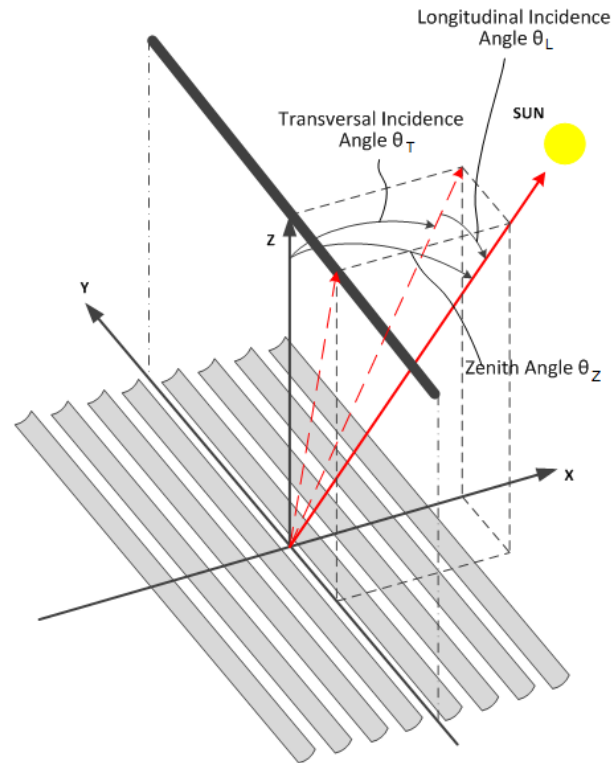
**Solar position table**

The solar position table option allows you to specify optical efficiency of the solar field as a function of solar azimuth and zenith angles. SAM uses a solar azimuth angle convention where true North is equal to  $-180/+180^\circ$  and South equals  $0^\circ$ . The solar zenith angle is zero when the sun is directly overhead and  $90^\circ$  when the sun is at the horizon.

The solar position may contain any number of rows and columns, but should contain enough information to fully define the performance of the solar field at all sun positions for which the field will operate. The table must contain more than one row and column.

**Collector incidence angle table**

The collector incidence angle table option allows you to specify solar field optical efficiency as a function of the longitudinal and transversal solar incidence angles. The collector incidence angles are defined as shown in the following figure, where the transversal incidence angle is given as  $\phi_T$  and the longitudinal incidence angle is  $\phi_L$ . The solar zenith angle is  $\theta_z$ .



### IAM polys

The incidence angle modifier option allows you to specify optical performance of the solar field collectors using polynomial equations (up to fourth order) in both the transversal and longitudinal incidence angle directions. Refer to the Collector incidence angle table input documentation (above) for descriptions of the transversal ( $\phi_T$ ) and longitudinal ( $\phi_L$ ) collector angles.

## Solar Position/Collector Incidence Angle Table

### Import

Import a table from a text or data file. The file can contain values separated by comma, space, or tab characters, but must be formatted according to the following rules:

- The first row in the file specifies the angles for the solar azimuth (for the Solar position table) or collector transversal incidence (for the Collector incidence angle table). The first entry of this row should be blank.
- Each additional row specifies optical efficiency for a specific zenith angle (for the Solar position table) or longitudinal incidence angle (for the Collector incidence angle table). The first entry of the row must be the zenith or longitudinal incidence angle corresponding to the optical efficiency entries in that row.
- The rows of the table should be sorted according to zenith/longitudinal incidence angle from lowest to highest.

An example tab-delimited table is as follows, where numbers in bold correspond to the solar zenith (row headers) and azimuth (column headers) angles:

	<b>-180</b>	<b>90</b>	<b>0</b>	<b>90</b>	<b>180</b>
<b>0</b>					
<b>15</b>					
<b>30</b>					
<b>45</b>					
<b>60</b>					
<b>75</b>					
<b>90</b>					

<b>0</b>	1.0	1.0	1.0	1.0	1.0
<b>30</b>	0.95	0.98	0.99	0.98	0.95
<b>60</b>	0.60	0.70	0.75	0.70	0.60
<b>90</b>	0.0	0.0	0.0	0.0	0.0

Note that SAM automatically sizes the table on the Collector and Receiver page to match the size of the array that is being imported.

### Export

Export the optical efficiency table on the Collector and Receiver page to a text file.

### Copy

Copy the optical efficiency table on the Collector and Receiver page to the clipboard for transfer to an optical efficiency table in another case or to other text applications.

### Paste

Paste an optical efficiency table from another SAM case or from a text file into the active case.

### Rows

Specify the number of desired rows in the table.

### Cols

Specify the number of desired columns in the table.

## Incidence Angle Modifier Coefficients

This option allows you to specify the optical performance of the collector field as functions of the transversal and longitudinal incidence angles where the performance is expressed in polynomial form.

### Transverse incidence angle modifier

The incidence angle modifier polynomial for the transversal incidence angle, as defined in the documentation for the collector incidence angle table (above). The polynomial to calculate the optical efficiency reduction associated with deviation of the irradiation incidence angle in the transversal plane is as follows:

$$IAM_T = C_0 + C_1 \cdot \phi_T + C_2 \cdot \phi_T^2 + C_3 \cdot \phi_T^3 + C_4 \cdot \phi_T^4$$

where  $\phi_T$  is the transversal incidence angle.

### Longitudinal incidence angle modifier

The incidence angle modifier polynomial for the longitudinal incidence angle, as defined in the documentation for the collector incidence angle table (above). The polynomial to calculate the optical efficiency reduction associated with deviation of the irradiation incidence angle in the longitudinal plane is as follows:

$$IAM_L = C_0 + C_1 \cdot \phi_L + C_2 \cdot \phi_L^2 + C_3 \cdot \phi_L^3 + C_4 \cdot \phi_L^4$$

where  $\phi_L$  is the longitudinal incidence angle.

## Receiver Geometry and Heat Loss

### Receiver model type

You can specify the thermal losses from the solar field receiver components using one of two approaches:

**Polynomial heat loss model** allows general specification of thermal losses using polynomial equations. The polynomials provide heat loss as a function of steam temperature with a correction based on wind velocity, and heat loss is evaluated at each collector module in the loop.

**Evacuated tube model** allows the use of a detailed evacuated tube receiver model. Select the model using the dropdown menu in this section.

## Polynomial fit heat loss model

These inputs are active for the polynomial heat loss receiver model.

### HTF temperature adjustment

This polynomial gives thermal losses in the solar field receiver component as a function of the difference between HTF temperature and ambient dry-bulb temperature in degrees Celsius. Thermal losses are evaluated at each collector module in the loop using the following expression for the coefficient of heat loss [W/m]:

$$F_{hl}(T) = C_0 + C_1 \cdot \Delta T_{local} + C_2 \cdot \Delta T_{local}^2 + C_3 \cdot \Delta T_{local}^3 + C_4 \cdot \Delta T_{local}^4$$

where  $\Delta T_{local}$  is the local (to the module) difference between the steam temperature and ambient dry bulb temperature.

### Wind velocity adjustment

SAM allows you to adjust the thermal loss coefficient calculated from the Steam temperature adjustment polynomial ( $F_{hl}(T)$ ). The resulting value from the wind velocity polynomial multiplies the steam temperature heat loss polynomial, as follows:

$$F_{hl}(V_{wind}) = C_0 + C_1 \cdot V_{wind} + C_2 \cdot V_{wind}^2 + C_3 \cdot V_{wind}^3 + C_4 \cdot V_{wind}^4$$

$$F_{hl,total} = F_{hl}(T) \cdot F_{hl}(V_{wind})$$

### Pressure drop at design, bar

The decrease in HTF pressure across an SCA unit under design-point operating conditions. The total pressure loss is used to calculate pumping parasitic requirements. The pressure is scaled during simulation using the Part-load pressure loss adjustment coefficients (C0-C3), which are a function of normalized mass flow rate.

### Part-load pressure loss adjustment

Polynomial coefficients describing how pressure loss varies as a function of normalized mass flow rate during simulation. The pressure loss in a single SCA is calculated as follows:

$$\Delta P_{sca} = \Delta P_{des} \left( C_0 + C_1 \left( \frac{\dot{m}}{\dot{m}_{des}} \right) + C_2 \left( \frac{\dot{m}}{\dot{m}_{des}} \right)^2 + C_3 \left( \frac{\dot{m}}{\dot{m}_{des}} \right)^3 \right)$$

Where  $\dot{m}$  is the mass flow rate at any given time step,  $\dot{m}_{des}$  is the mass flow rate through the SCA at design, and  $\Delta P_{des}$  is the Pressure drop at design that you specify.

### Total loop pressure loss at design

The total pressure loss through a solar field loop at design. This calculated value is equal to the design-point pressure multiplied by the Number of collector modules in a loop that you specify on the Solar Field page. The pressure loss during simulation is scaled according to the Part-load pressure loss adjustment equation.

## Evacuated tube heat loss model

These inputs are active for the evacuated tube receiver model.

**Absorber tube inner diameter (m)**

Inner diameter of the receiver absorber tube, this surface in direct contact with the heat transfer fluid.

**Absorber tube outer diameter (m)**

Outer diameter of the receiver absorber tube, the surface exposed to the annular vacuum.

**Glass envelope inner diameter (m)**

Inner diameter of the receiver glass envelope tube, the surface exposed to the annular vacuum.

**Glass envelope outer diameter (m)**

Outer diameter of the receiver glass envelope tube, the surface exposed to ambient air.

**Absorber flow plug diameter (m)**

A non-zero value represents the diameter of an optional plug running axially and concentrically within the receiver absorber tube. A zero value represents a receiver with no plug. The plug allows for an increase in the receiver absorber diameter while maintaining the optimal heat transfer within the tube heat transfer fluid. For a non-zero value, be sure to use annular flow for the absorber flow pattern option.

**Internal surface roughness**

The surface roughness of the inner receiver pipe surface exposed to the heat transfer fluid, used to determine flow shear force and the corresponding pressure drop across the receiver.

Surface roughness is important in determining the scale of the pressure drop throughout the system. As a general rule, the rougher the surface, the higher the pressure drop (and parasitic pumping power load). The surface roughness is a function of the material and manufacturing method used for the piping. A conservative roughness value for extruded steel pipe (the type often used for the absorber pipe) is about  $3\text{e-}6$  meters. The default value of  $4.5\text{e-}5$  m is based on this value and the absorber tube inner diameter value of 0.066 m:  $3\text{e-}6 \text{ m} / 6.6\text{e-}2 \text{ m} = 4.5\text{e-}5$ .

**Absorber flow pattern (m)**

Use standard tube flow when the absorber flow plug diameter is zero. Use annular flow with a non-zero absorber flow plug diameter.

**Absorber material type**

The material used for the absorber tube. Choose from stainless steel or copper.

**Variant weighting fraction**

The fraction of the solar field that consists of the active receiver variation. For each receiver type, the sum of the four variations should equal one. You can use the receiver variations to model a solar field with receivers in different conditions. If you want all of the receivers in the field to be identical, then you can use a single variation and assign it a variant weighting fraction of 1.

When you use more than one receiver variation, be sure that the sum of the four variant weighting fractions is 1.

Here's an example of an application of the receiver variations for a field that consists of a two receiver types. The first type, Type 1, represents receivers originally installed in the field. Type 2 represents replacement receivers installed as a fraction of the original receivers are damaged over time.

Over the life of the project, on average, 5 percent of the Type 1 receivers have broken glass envelopes, and another 5 percent have lost vacuum in the annulus. We'll also assume that degraded receivers are randomly distributed throughout the field -- SAM does not have a mechanism for specifying specific locations of different variations of a given receiver type. To specify this situation, we would start with Type 1, and use Variation 1 to represent the 90 percent of intact receivers, assigning it a variant



weighting fraction of 0.90. We'll use Variation 2 for the 5 percent of receivers with broken glass envelopes, giving it a weighting fraction of 0.05, and Variation 3 for the other 5 percent of lost-vacuum receivers with a weighting fraction of 0.05. We'll assign appropriate values to the parameters for each of the two damaged receiver variations.

Next, we'll specify Type 2 to represent intact replacement receivers. We will use a single variation for the intact Type 2 receivers.

On the Solar Field page, we'll specify the single loop configuration (assuming a loop with eight assemblies), using Type 2 for the first and second assembly in the loop, and Type 1 receivers (with the variant weighting we assigned on the Receivers page) for the remaining six assemblies in the loop

**Absorber absorptance**

The ratio of radiation absorbed by the absorber to the radiation incident on the absorber.

**Absorber emittance**

The energy radiated by the absorber surface as a function of the absorber's temperature. You can either specify a table of emittance and temperature values, or specify a single value that applies at all temperatures.

**Envelope absorptance**

The ratio of radiation absorbed by the envelope to the radiation incident on the envelope, or radiation that is neither transmitted through nor reflected from the envelope. Used to calculate the glass temperature. (Does not affect the amount of radiation that reaches the absorber tube.)

**Envelope emittance**

The energy radiated by the envelope surface.

**Envelope transmittance**

The ratio of the radiation transmitted through the glass envelope to the radiation incident on the envelope, or radiation that is neither reflected nor refracted away from the absorber tube.

**Broken glass**

Option to specify that the envelope glass has been broken or removed, indicating that the absorber tube is directly exposed to the ambient air.

**Annulus gas type**

Gas type present in the annulus vacuum. Choose from Hydrogen, air, or Argon.

**Annulus pressure (torr)**

Absolute pressure of the gas in the annulus vacuum, in torr, where 1 torr = 133.32 Pa

**Estimated avg. heat loss (W/m)**

An estimated value representing the total heat loss from the receiver under design conditions. SAM uses the value to calculate the total loop conversion efficiency and required solar field aperture area for the design point values on the Solar Field page. It does not use the value in simulation calculations.

**Bellows shadowing**

An optical derate factor accounting for the fraction of radiation lost after striking the mechanical bellows at the ends of the receiver tubes.

**Dirt on receiver**

An optical derate factor accounting for the fraction of radiation lost due to dirt and soiling on the receiver.

## Aggregate Weighted Losses

### Average field temp difference at design

The effective temperature for thermal loss estimates, equal to the average solar field temperature. This temperature is used to evaluate thermal losses from the solar field receivers (polynomial heat loss model only) and from piping as specified on the Parasitics page. This value is calculated as the average of the Field inlet temperature and Field outlet temperature on the Solar Field page.

### Heat loss at design

Calculated estimate of thermal losses at the Average field temp difference at design. In the case of the polynomial heat loss model, the estimate is calculated based on the difference between the average temperature and the design-point ambient temperature from the Solar Field page. In the case of the evacuated tube receiver model, the estimate is based on the user-specified Estimated avg. heat loss values on the Collector and Receiver page.

### Receiver thermal derate

Calculated value indicating the estimated thermal efficiency of the solar field receivers. This value is calculated based on the Heat loss at design calculated value, and is used only to size the solar field aperture area. Note that this value is not used in annual hourly performance calculations.

### Receiver optical derate

The reduction in optical efficiency associated with envelope transmittance and receiver soiling. This derate is calculated as a weighted sum for the four receiver variants and only applies to the evacuated receiver model option.

### Collector optical loss at normal incidence

The optical efficiency from the optical table or incident angle modifier polynomials at normal solar incidence.

## 20.4.3 Power Cycle

The power cycle converts thermal energy to electric energy. The power cycle is assumed to consist of a superheated two-stage turbine with multiple extractions for feedwater heating and a reheat extraction between the high and low pressure turbine stages. You specify the design-point efficiency of this cycle on the Power Cycle page, and SAM models the part-load behavior with normalized performance curves as a function of steam inlet temperature, mass flow rate, and ambient temperature. The ambient temperature correction uses the wet-bulb temperature for wet-cooled systems and hybrid systems and the dry-bulb temperature for dry cooled and hybrid cooled systems.

The power cycle page displays variables that specify the design operating conditions for the steam Rankine cycle used to convert thermal energy to electricity.

## Plant Capacity

### Reference output electric power at design condition, MWe

The power cycle's design output, not accounting for parasitic losses.

### Estimated gross to net conversion factor

An estimate of the ratio of the electric energy delivered to the grid to the power cycle's gross output. SAM uses the factor to calculate the power cycle's nameplate capacity for capacity-related calculations, including the estimated total cost per net capacity value on the System Costs page, and the capacity factor reported in the results.

### Estimated net output at design (nameplate), MWe

The power cycle's nameplate capacity, calculated as the product of the design gross output and estimated gross to net conversion factor.

$$\text{Net Nameplate Capacity (MWe)} = \text{Reference Output (MWe)} \times \text{Estimated Gross to Net Conversion Factor}$$

## System Availability

System availability losses are reductions in the system's output due to operational requirements such as maintenance down time or other situations that prevent the system from operating as designed.

**Note.** To model curtailment, or forced outages or reduction in power output required by the grid operator, use the inputs on the [Grid Limits](#) page.

To edit the system availability losses, click **Edit losses**.

The [Edit Losses](#) window allows you to define loss factors as follows:

- Constant loss is a single loss factor that applies to the system's entire output. You can use this to model an availability factor.
- Hourly losses apply to specific hours of the year.

SAM reduces the system's output in each hour by the loss percentage that you specify for that hour. For a given hour, a loss of zero would result in no adjustment. A loss of 5% would reduce the output by 5%, and a loss of -5% would increase the output value by 5%. For subhourly simulations, SAM applies the loss factor for a given hour to each time step in that hour

## Power Block Design Point

### Rated cycle conversion efficiency

The thermal to electric conversion efficiency of the power cycle under design conditions.

### Reference HTF outlet temperature at design, °C

The design temperature in degrees Celsius of the cold heat transfer fluid at the power block outlet. The design values are the operating conditions at which the power block operates at its nameplate capacity.

### Reference HTF inlet temperature at design, °C

The design temperature in degrees Celsius of the hot heat transfer fluid at the power block inlet. Design HTF inlet temperature can be different from receiver outlet temperature when power block design specifications require a different inlet temperature for maximum efficiency. The design values are the operating conditions at which the power block operates at its nameplate capacity.

### Boiler operating pressure, bar

The saturation pressure of the steam as it is converted from liquid to vapor in the boiler or steam generator. SAM uses this value to determine the steam's saturation temperature and thus the superheating capability of the heat exchangers. The temperature difference that drives the steam mass

flow rate in the Rankine cycle is the difference between the hot heat transfer fluid inlet temperature and the saturation temperature of the steam boiler pressure.

#### Power block blowdown steam fraction

The fraction of the steam mass flow rate in the power cycle that is extracted and replaced by fresh water. This fraction is multiplied by the steam mass flow rate in the power cycle for each hour of plant operation to determine the total required quantity of power cycle makeup water. The blowdown fraction accounts for water use related directly to replacement of the steam working fluid. The default value of 0.013 for the wet-cooled case represents makeup due to blowdown quench and steam cycle makeup during operation and startup. A value of 0.016 is appropriate for dry-cooled systems to account for additional wet-surface air cooling for critical Rankine cycle components.

#### Fossil backup boiler LHV efficiency

The auxiliary fossil backup boiler's lower heating value efficiency, used to calculate the quantity of natural gas required by the boiler.

If your system includes an auxiliary boiler, choose a fossil dispatch mode and define the fossil fill fractions as described below.

#### Aux heater outlet set temp, °C

The temperature set point for the auxiliary heaters for the fossil backup system.

#### Fossil dispatch mode

The fossil dispatch mode determines how the optional auxiliary fossil (natural gas) backup boiler is configured and how it operates. Use the **fossil fill fraction** input under **Dispatch Control** on the [Thermal Storage](#) page to determine when the auxiliary boiler operates. Use the fossil backup boiler LHV efficiency value under Plant Design to define the boiler's lower heating value efficiency.

If your system has an auxiliary fossil backup boiler, and you want to account for fuel costs in the financial model, you should assign a fossil fuel cost under Operation and Maintenance costs on the [System Costs](#) page.

**Note.** If the **Fossil fill fraction** under **Dispatch Control** on the Thermal Storage page is zero for all periods, the system does not include an auxiliary fossil backup boiler, and you can ignore the fossil dispatch mode input.

#### Minimum backup level

In the Minimum Backup Level mode, the auxiliary boiler is in parallel with the power cycle and supplies heat to the HTF at the power cycle inlet when the solar field thermal output falls below the level defined by the fossil fill fractions and weekday/weekend schedules.

For example, for an hour with a fossil fill fraction of 1.0 when solar energy delivered to the power cycle is less than that the design thermal input power, the auxiliary boiler would supply enough energy to "fill" the missing heat so that the thermal power at the power cycle inlet is at the design point. If, in that scenario, solar energy from the field is driving the power cycle at full load, the auxiliary boiler would not operate. For a fossil fill fraction of 0.75, the auxiliary boiler would only be fired when solar output drops below 75% of the power cycle's design thermal input power.

#### Supplemental operation

In the Supplemental Operation mode, the auxiliary boiler is in parallel with the power cycle and supplies sufficient heat to the HTF at the power cycle inlet for the power cycle to operate at its design point, where the design point is determined by the fossil fill fractions and weekday/weekend schedules.

Operation of the power cycle in a given hour is constrained by the **Max turbine over design operation fraction** and **Minimum operation fraction**. For hours that the energy added by the auxiliary backup boiler is insufficient to meet the minimum requirement, the backup boiler is not dispatched.

## Plant Control

### Low resource standby period, hours

During periods of insufficient flow from the heat source due to low thermal resource, the power block may enter standby mode. In standby mode, the cycle can restart quickly without the startup period required by a cold start. The standby period is the maximum number of hours allowed for standby mode. This option is only available for systems with thermal storage. Default is 2 hours.

### Fraction of thermal power needed for standby

The fraction of the turbine's design thermal input required from storage to keep the power cycle in standby mode. This thermal energy is not converted into electric power. Default is 0.2.

### Time needed for power block startup, hours

The time in hours that the system consumes energy at the startup fraction before it begins producing electricity. If the startup fraction is zero, the system will operate at the design capacity over the startup time. Default is 0.5 hours.

### Fraction of thermal power needed for startup

The fraction of the turbine's design thermal input required by the system during startup. This thermal energy is not converted to electric power. Default is 0.75.

### Startup temperature

The minimum HTF temperature at the power cycle inlet required for the power cycle to start after a period of not running.

### Maximum turbine over design operation fraction

The maximum allowable power block output as a fraction of the electric nameplate capacity. Whenever storage is not available and the solar resource exceeds the design value of 950 W/m<sup>2</sup>, some heliostats in the solar field are defocused to limit the power block output to the maximum load. Default is 1.05.

### Minimum turbine operation fraction before shutdown

The fraction of the nameplate electric capacity below which the power block does not generate electricity. Whenever the power block output is below the minimum load and thermal energy is available from the solar field, the field is defocused. For systems with storage, solar field energy is delivered to storage until storage is full. Default is 0.25.

### Turbine inlet pressure control

Determines the power cycle working fluid pressure during off-design loading.

**Fixed Pressure:** The power block maintains the design high pressure of the power cycle working fluid during off-design loading.

**Sliding Pressure:** The power block decreases the high pressure of the power cycle working fluid during off-design loading.

## Cooling System

### Condenser type

The type of cooling system: Air-cooled condenser (dry cooling), evaporative cooling (wet cooling), or hybrid cooling system.

In hybrid cooling a wet-cooling system and dry-cooling share the heat rejection load. Although there are many possible theoretical configurations of hybrid cooling systems, SAM only allows a parallel cooling option.

### Reference ambient temperature at design point, °C

The ambient temperature at which the power cycle operates at its design-point-rated cycle conversion efficiency. For the air-cooled condenser option, use a dry bulb ambient temperature value. For the evaporative condenser, use the wet bulb temperature.

### Reference condenser cooling water inlet/outlet T diff, °C

For the evaporative type only. The temperature rise of the cooling water across the condenser under design conditions, used to calculate the cooling water mass flow rate at design, and the steam condensing temperature.

### Cooling tower approach temperature, °C

For the evaporative type only. The temperature difference between the circulating water at the condenser inlet and the wet bulb ambient temperature, used with the ref. condenser water dT value to determine the condenser saturation temperature and thus the turbine back pressure.

### ITD at design point for dry system(°C)

For the air-cooled type only. Initial temperature difference (ITD), difference between the temperature of steam at the turbine outlet (condenser inlet) and the ambient dry-bulb temperature.

**Note.** When you adjust the ITD, you are telling the model the conditions under which the system will achieve the thermal efficiency that you've specified. If you increase the ITD, you should also modify the thermal efficiency (and/or the design ambient temperature) to accurately describe the design-point behavior of the system. The off-design penalty in the modified system will follow once the parameters are corrected.

### Condenser pressure ratio

For the air-cooled type only. The pressure-drop ratio across the air-cooled condenser heat exchanger, used to calculate the pressure drop across the condenser and the corresponding parasitic power required to maintain the air flow rate.

### Minimum condenser pressure

The minimum condenser pressure in inches of mercury prevents the condenser pressure from dropping below the level you specify. In a physical system, allowing the pressure to drop below a certain point can result in physical damage to the system. For evaporative (wet cooling), the default value is 1.25 inches of mercury. For air-cooled (dry cooling), the default is 2 inches of mercury. For hybrid systems, you can use the dry-cooling value of 2 inches of mercury.

### Number of part-load increments for heat rejection

The cooling system part load levels tells the heat rejection system model how many discrete operating points there are. A value of 2 means that the system can run at either 100% or 50% rejection. A value of three means rejection operating points of 100% 66% 33%. The part load levels determine how the heat

rejection operates under part load conditions when the heat load is less than full load. The default value is 2, and recommended range is between 2 and 10. The value must be an integer.

## 20.4.4 Thermal Storage

A thermal energy storage system (TES) stores heat from the solar field in a liquid medium. Heat from the storage system can drive the power block turbine during periods of low or no sunlight. A thermal storage system is beneficial in many locations where the peak demand for power occurs after the sun has set. Adding thermal storage to a parabolic trough system allows the collection of solar energy to be separated from the operation of the power block. For example, a system might be able to collect energy in the morning and use it to generate electricity late into the evening.

In direct storage systems, the solar field's heat transfer fluid itself serves as the storage medium. In indirect systems, a separate fluid is the storage fluid, and heat is transferred from the solar field's heat transfer fluid to the storage fluid through heat exchangers. The thermal storage system consists of one or more tank pairs, pumps to circulate the liquids, and depending on the design, heat exchangers. Each tank pair consists of a hot tank to store heat from the solar field, and a cold tank to store the cooled storage medium after the power block has extracted its energy.

**Note.** SAM's thermal energy storage model for linear Fresnel systems is the same as for the other CSP models. For a detailed explanation of the model, see Chapter 4 of Wagner, M. J.; Gilman, P. (2011). *Technical Manual for the SAM Physical Trough Model*. 124 pp.; NREL Report No. TP-5500-51825. ([PDF 3.7 MB](#))

### Storage System

#### Equivalent full-load thermal storage hours, hours

The thermal storage capacity expressed in number of hours of thermal energy delivered at the power block's design thermal input level. The physical capacity is the number of hours of storage multiplied by the power cycle design thermal input. Used to calculate the system's maximum storage capacity.

#### Total tank volume, m<sup>3</sup>

SAM calculates the total heat transfer fluid volume in storage based on the storage hours at full load and the power block design turbine thermal input capacity. The total heat transfer fluid volume is divided among the total number of tanks so that all hot tanks contain the same volume of fluid, and all cold tanks contain the same volume of fluid. See [Equations for Calculated Values](#).

#### TES thermal capacity, MWht

The equivalent thermal capacity of the storage tanks, assuming the thermal storage system is fully charged. This value does not account for losses incurred through the heat exchanger for indirect storage systems. See [Equations for Calculated Values](#).

#### Number of equivalent tank pairs

The number of parallel hot-cold storage tank pairs. Increasing the number of tank-pairs also increases the volume of the heat transfer fluid exposed to the tank surface, which increases the total tank thermal losses. SAM divides the total heat transfer fluid volume among all of the tanks, and assumes that each hot tank contains an equal volume of fluid, and each cold tank contains an equal volume.

**Height of HTF when tank is full, m**

The height of the cylindrical volume of heat transfer fluid in each tank.

**Minimum tank fluid height, m**

The minimum allowable height of fluid in the storage tank(s). The mechanical limits of the tank determine this value.

**Tank diameter, m**

The diameter of a storage tank, assuming that all tanks have the same dimensions. SAM calculates this value based on the specified height and storage volume of a single tank, assuming that all tanks have the same dimensions. See [Equations for Calculated Values](#).

**Min fluid volume, m<sup>3</sup>**

The volume of fluid in a tank that corresponds to the tank's minimum fluid height specified above. See [Equations for Calculated Values](#).

**Loss coefficient from the tank, W/m<sup>2</sup>-K**

The thermal loss coefficient for the storage tanks. This value specifies the number of thermal watts lost from the tanks per square meter of tank surface area and temperature difference between the storage fluid bulk temperature and the ambient dry bulb temperature.

**Estimated tank heat loss, MWt**

The estimated value of heat loss from all storage tanks. The estimate assumes that the tanks are 50% charged, so that the storage fluid is evenly distributed among the cold and hot tanks, and that the hot tank temperature is equal to the solar field hot (outlet) temperature, and the cold tank temperature is equal to the solar field cold (inlet) temperature. See [Equations for Calculated Values](#).

**Cold and hot tank heater set points, °C**

The minimum allowable storage fluid temperature in the storage tanks. If the fluid temperature falls below the set point, the electric tank heaters deliver energy to the tanks, attempting to increase the temperature to the set point. SAM reports this energy in the performance model results as "Tank freeze protection energy."

**Tank heater capacity, MWt**

The maximum rate at which heat can be added by the electric tank heaters to the storage fluid in the tanks.

**Tank heater efficiency**

The electrical to thermal conversion efficiency of the electric tank heaters.

**HTF freeze protection mode**

Determines whether freeze protection energy is provided by electricity or fossil (natural gas).

**Hot side HX approach temp, °C**

Applies to systems with a heat exchanger only (indicated by a heat exchanger derate value of less than one). The temperature difference on the hot side of the solar-field-to-thermal-storage heat exchanger. During charge cycles, the temperature is the solar field hot outlet temperature minus the storage hot tank inlet temperature. During discharge cycles, it is defined as the storage hot tank temperature minus the power cycle hot inlet temperature.

**Cold side HX approach temp, °C**

Applies to systems with a heat exchanger only (indicated by a heat exchanger derate value less than one). The temperature difference on the cold side of the solar field-to-thermal-storage heat exchanger.



During charge cycles, the temperature is the storage cold temperature (storage outlet) minus the heat exchanger cold temperature. During discharge cycles, it is the heat exchanger cold temperature minus the storage cold temperature (storage inlet).

### Thermal storage exergetic efficiency

A calculated value indicating the temperature derate caused by the heat exchanger approach temperatures. The derate factor is for reference only and not used in performance calculations. The derate is defined as the temperature difference between the hot and the cold field design temperatures minus the heat exchanger approach temperatures all divided by the difference between the hot and cold field design temperatures. A derate of one indicates a system that uses the same fluid for the solar field heat transfer fluid and for the storage fluid and therefore does not require a heat exchanger between the solar field and storage system. See [Equations for Calculated Values](#).

**Note.** If you specify user-defined HTF fluids with the same properties for the solar field and thermal storage system, SAM disables the Hot side HX approach temp and Cold side HX approach temp inputs, and sets them to zero internally to represent a system with no heat exchanger. (When the hot and cold side approach temperatures are zero, Thermal storage exergetic efficiency is one.)

### Storage HTF fluid

The storage fluid used in the thermal energy storage system.

When the storage fluid and solar field heat transfer fluid (HTF) are different, the system is an indirect system with a heat exchanger (heat exchanger derate is less than one).

When the storage fluid and solar field HTF are the same, the system is a direct system that uses the solar field HTF as the storage medium. For a direct system, SAM disables the **Hot side HX approach temp** and **Cold side HX approach temp** variables, and sets the **Heat exchanger derate** value to one. See the [Solar Field](#) page for table of fluid properties.

### User-defined HTF fluid

When you choose user-defined from the Storage HTF fluid list, you can specify a table of material properties of a storage fluid. You must provide values for two temperatures (two rows of data) of specific heat, density, viscosity, and conductivity values. See [Custom HTF](#) for details.

### Storage HTF min operating temp, °C

The minimum HTF operating temperature recommended by the HTF manufacturer.

In some cases the minimum operating temperature may be the same as the fluid's freeze point. However, at the freeze point the fluid is typically significantly more viscous than at design operation temperatures, so it is likely that the "optimal" minimum operating temperature is higher than the freeze point.

### Storage HTF max operating temp, °C

The minimum HTF operating temperature recommended by the HTF manufacturer.

Operation at temperatures above this value may result in degradation of the HTF and be unsafe. To avoid this, you may want to include a safety margin and use a maximum operating temperature value slightly lower than the recommended value.

**Notes.**

SAM displays the operating temperature limits for your reference so you can compare them to the storage temperatures reported in the results to ensure that they do not exceed the limits. SAM does not adjust the system's performance to avoid exceeding these operating limits.

SAM only displays these limits for fluids that are in SAM's library. If you use a custom HTF instead of one from the SAM library, SAM disables the HTF operating temperature limits. In this case, you should use data from the fluid manufacturer specifications.

**Fluid Temperature, °C**

A reference value indicating the temperature at which the substance properties are evaluated for thermal storage. See [Equations for Calculated Values](#).

**TES fluid density, kg/m<sup>3</sup>**

The density of the storage fluid at the fluid temperature, used to calculate the total mass of thermal fluid required in the storage system. See [Equations for Calculated Values](#).

**TES specific heat, kJ/kg-K**

The specific heat of the storage fluid at the fluid temperature, used to calculate the total energy content of the fluid in the storage system. See [Equations for Calculated Values](#).

**Equations for Calculated Values**

The following table shows the equations SAM uses to calculate the values for the variables above that you cannot edit. (In Windows, the calculated values appear in blue.)

Variable	Equation	Note
Storage volume	$V_{TES} = \frac{C * 1e6 * 3600}{\rho_{HTF} * c_{htf} * 1000 * \mu_{hx} * ((T_{sf,out} - T_{hx,hot}) - (T_{sf,in} - T_{hx,cold}))}$	$t_{full\ load}$ is the number of full-load hours of thermal storage
TES thermal capacity	$C = \frac{\dot{W}_{des,gross}}{\eta_{des}} * t_{full\ load}$	
Tank diameter	$D_{tank} = 2 * \sqrt{\frac{V_{TES}}{h_{tank} * \pi * N_{pairs}}}$	$h_{tank}$ is the tank height; $N_{pairs}$ is the number of tank pairs; $V_{TES}$ is the Storage Volume
Min fluid volume	$V_{min} = V_{TES} * \frac{h_{min}}{h_{tank}}$	

Estimated heat loss	$hl_{TES} = \left( h_{tank} * \pi * D_{tank} + \pi * \left( \frac{D_{tank}}{2} \right)^2 \right) * N_{pairs} * (T_{TES,ave} - 20) * C_{hl,tank}$	Equivalent to the product of the total interacting tank area, number of tank pairs, temperature difference with ambient, and heat loss coefficient
Heat exchanger derate	$\mu_{hx} = \frac{T_{hot,approach} + T_{cold,approach}}{T_{sf,out} - T_{sf,in}}$	
Fluid temperature	$T_{HTF} = \frac{T_{sf,out} + T_{sf,in}}{2}$	Average fluid temperature for evaluating TES properties
TES fluid density	$\rho_{HTF}$	Lookup function for density, evaluated at Fluid temperature
TES specific heat	$c_{HTF}$	Lookup function for specific heat, evaluated at Fluid temperature

## Dispatch Control

The thermal storage dispatch controls determine the timing of releases of energy from the thermal energy storage and fossil backup systems to the power block. When the system includes thermal energy storage or fossil backup, SAM can use a different dispatch strategy for up to six different dispatch periods.

SAM decides whether or not to operate the power cycle in each hour of the simulation based on how much energy is available in storage, how much energy is delivered by the solar field, and the values of the thermal storage dispatch control parameters. You can define a different dispatch strategy for each of six dispatch periods for weekdays and weekends. For each hour, SAM also decides whether to supplement solar energy with energy from the fossil backup system.

### Storage dispatch with solar

The fraction of the TES maximum storage capacity indicating the minimum level of charge that the storage system can discharge to while the solar field is producing power. A value of zero will always dispatch the TES in any hour assigned to the given dispatch period; a value of one will never dispatch the TES. Used to calculate the storage dispatch levels.

### Storage dispatch without solar

The fraction of the TES maximum storage capacity indicating the minimum level of charge that the storage system can discharge to while no solar resource is available. A value of zero will always dispatch the TES in any hour assigned to the given dispatch period; a value of one will never dispatch the TES. Used to calculate the storage dispatch levels.

### Turbine output fraction

The fraction of design-point thermal load to the power block before part-load and temperature efficiency corrections. These values allow the user to dispatch the power cycle at a desired level according to the time-of-dispatch period. See below for details.

### Fossil fill fraction

A fraction of the power block design turbine gross output from the Power Block page that can be met by the backup boiler. Used by the power block module to calculate the energy from the backup boiler. See below for details.

If you specify a fossil fill fraction other than zero for one or more periods and want to account for fuel costs in the financial model, you should assign a fossil fuel cost under Operation and Maintenance costs on the [System Costs](#) page.

## Storage Dispatch

For each hour in the simulation, SAM looks at the amount of energy in storage at the beginning of the hour and decides whether or not to operate the power cycle in that hour. For each dispatch period, there are two dispatch targets for starting or continuing to run the power cycle: one for periods of sunshine (**storage dispatch fraction w/solar**), and one for periods of no sunshine (**storage dispatch fraction w/o solar**). The dispatch target for each dispatch period is the product of the storage dispatch fraction for that period and the thermal storage capacity defined by the TES thermal capacity input variable.

- During periods of sunshine when there is insufficient energy from the solar field to drive the power cycle at its load requirement, the system dispatches energy from storage only when energy in storage is greater than or equal to the dispatch target.
- During periods of no sunshine, the power cycle will not run unless energy in storage is greater than or equal to the dispatch target.

The **turbine output fraction** for each dispatch period determines the power cycle output requirement for hours that fall within the dispatch period. A turbine output fraction of one defines an output requirement equivalent to the power cycle's design gross output defined on the [Power Cycle](#) page. For hours when the solar field energy is insufficient to drive the power cycle at the output requirement, the power cycle runs on energy from both the solar field and storage system. For hours when the solar field energy exceeds the output requirement, the power block runs at the required output level, and any excess energy goes to storage. If the storage system is at capacity, the collectors in the field defocus as specified on the [Solar Field](#) page to reduce the field's thermal output.

By setting the thermal storage dispatch control parameters, you can simulate a dispatch strategy for clear days when storage is at capacity that allows the operator to start the plant earlier in the day to avoid defocusing collectors in the field, for cloudy days that allows the operator to store energy for later use in a time period when the value of power is higher.

## Fossil Fill

The **fossil fill fraction** defines the size of the fossil backup as a fraction of the power cycle design gross output. The quantity of fossil backup energy also depends on the **fossil backup boiler LHV efficiency**, **aux heater outlet set temp**, and **fossil dispatch mode parameters** on the Power Cycle page. is added to the input from the solar field and storage system.

Operation of the power block in a given hour with fossil backup is constrained by the **Turb out fraction** you specify for each period, and the **Max turbine over design operation** and **Min turbine operation** from the Power Cycle page. For hours that the added fossil energy is insufficient to meet the **Min turbine operation** requirement, fossil backup is not dispatched. For hours when the combined fossil and solar contribution

exceeds the **Turb out fraction** for the hour, the amount of fossil energy dispatched is reduced until the required turbine output is met.

### Dispatch Schedules

The weekday and weekend dispatch schedules determine when each of the six dispatch periods apply during throughout the year.

If your analysis includes [PPA price multipliers](#) and you want to use the same schedule for the multipliers and for the power cycle dispatch control, click **Copy schedule from TOD Factors** page to apply the TOD Factors schedule matrices to the dispatch schedule matrices.

**Note.** SAM also uses the dispatch schedules when you choose Hybrid Cooling on the Power Cycle page to assign hybrid dispatch fractions to the periods specified in the dispatch schedules..

#### To specify a weekday or weekend schedule:

1. Assign values as appropriate to the Storage Dispatch, Turbine Output Fraction, and Fossil Fill Fraction for each of the up to nine periods.
2. Use your mouse to draw a rectangle in the matrix for the first block of time that applies to period 2.

	12am	1am	2am	3am	4am	5am	6am	7am	8am	9am	10am	11am	12pm	1pm	2pm	3pm	4pm	5pm	6pm	7pm	8pm	9pm	10pm	11pm
Jan	1	1	1	1	1	1	1	1	1	1	1	1	1	1	1	1	1	1	1	1	1	1	1	1
Feb	1	1	1	1	1	1	1	1	1	1	1	1	1	1	1	1	1	1	1	1	1	1	1	1
Mar	1	1	1	1	1	1	1	1	1	1	1	1	1	1	1	1	1	1	1	1	1	1	1	1
Apr	1	1	1	1	1	1	1	1	1	1	1	1	1	1	1	1	1	1	1	1	1	1	1	1
May	1	1	1	1	1	1	1	1	1	1	1	1	1	1	1	1	1	1	1	1	1	1	1	1
Jun	1	1	1	1	1	1	1	1	1	1	1	1	1	1	1	1	1	1	1	1	1	1	1	1
Jul	1	1	1	1	1	1	1	1	1	1	1	1	1	1	1	1	1	1	1	1	1	1	1	1
Aug	1	1	1	1	1	1	1	1	1	1	1	1	1	1	1	1	1	1	1	1	1	1	1	1
Sep	1	1	1	1	1	1	1	1	1	1	1	1	1	1	1	1	1	1	1	1	1	1	1	1
Oct	1	1	1	1	1	1	1	1	1	1	1	1	1	1	1	1	1	1	1	1	1	1	1	1
Nov	1	1	1	1	1	1	1	1	1	1	1	1	1	1	1	1	1	1	1	1	1	1	1	1
Dec	1	1	1	1	1	1	1	1	1	1	1	1	1	1	1	1	1	1	1	1	1	1	1	1

3. Type the number 2.

	12am	1am	2am	3am	4am	5am	6am	7am	8am	9am	10am	11am	12pm	1pm	2pm	3pm	4pm	5pm	6pm	7pm	8pm	9pm	10pm	11pm
Jan	1	1	1	1	1	1	1	1	1	1	1	1	1	1	1	1	1	1	1	1	1	1	1	1
Feb	1	1	1	1	1	1	1	1	1	1	1	1	1	1	1	1	1	1	1	1	1	1	1	1
Mar	1	1	1	1	1	1	1	1	1	1	1	1	1	1	1	1	1	1	1	1	1	1	1	1
Apr	1	1	1	1	1	1	1	1	1	1	1	1	1	1	1	1	1	1	1	1	1	1	1	1
May	1	1	1	1	1	1	1	1	1	1	2	2	2	2	2	2	1	1	1	1	1	1	1	1
Jun	1	1	1	1	1	1	1	1	1	1	2	2	2	2	2	2	1	1	1	1	1	1	1	1
Jul	1	1	1	1	1	1	1	1	1	1	2	2	2	2	2	2	1	1	1	1	1	1	1	1
Aug	1	1	1	1	1	1	1	1	1	1	2	2	2	2	2	2	1	1	1	1	1	1	1	1
Sep	1	1	1	1	1	1	1	1	1	1	1	1	1	1	1	1	1	1	1	1	1	1	1	1
Oct	1	1	1	1	1	1	1	1	1	1	1	1	1	1	1	1	1	1	1	1	1	1	1	1
Nov	1	1	1	1	1	1	1	1	1	1	1	1	1	1	1	1	1	1	1	1	1	1	1	1
Dec	1	1	1	1	1	1	1	1	1	1	1	1	1	1	1	1	1	1	1	1	1	1	1	1

- SAM shades displays the period number in the squares that make up the rectangle, and shades the rectangle to match the color of the period.

**Thermal Storage Dispatch Control**

Current dispatch schedule:

Note:  
 Schedule libraries do not affect the Storage Dispatch, Turbine Output and Fossil Fill fractions below.

	Storage Dispatch		Turb. out.	Fossil fill	Payment
	w/ solar*	w/o solar*	fraction*	fraction*	Allocation Factor
Period 1:	0	0	1.1	0	1
Period 2:	0	0	1	0.5	1
Period 3:	0	0	1	0	1
Period 4:	0	0	1	0	1
Period 5:	0	0	1	0	1
Period 6:	0	0	1	0	1
Period 7:	0	0	1	0	1
Period 8:	0	0	1	0	1
Period 9:	0	0	1	0	1

**Weekday Schedule**

	12am	1am	2am	3am	4am	5am	6am	7am	8am	9am	10am	11am	12pm	1pm	2pm	3pm	4pm	5pm	6pm	7pm	8pm	9pm	10pm	11pm
Jan	1	1	1	1	1	1	1	1	1	1	1	1	1	1	1	1	1	1	1	1	1	1	1	1
Feb	1	1	1	1	1	1	1	1	1	1	1	1	1	1	1	1	1	1	1	1	1	1	1	1
Mar	1	1	1	1	1	1	1	1	1	1	1	1	1	1	1	1	1	1	1	1	1	1	1	1
Apr	1	1	1	1	1	1	1	1	1	1	1	1	1	1	1	1	1	1	1	1	1	1	1	1
May	1	1	1	1	1	1	1	1	1	1	1	1	1	1	1	1	1	1	1	1	1	1	1	1
Jun	1	1	1	1	1	1	1	1	1	1	1	1	1	1	1	1	1	1	1	1	1	1	1	1
Jul	1	1	1	1	1	1	1	1	1	1	1	1	1	1	1	1	1	1	1	1	1	1	1	1
Aug	1	1	1	1	1	1	1	1	1	1	1	1	1	1	1	1	1	1	1	1	1	1	1	1
Sep	1	1	1	1	1	1	1	1	1	1	1	1	1	1	1	1	1	1	1	1	1	1	1	1
Oct	1	1	1	1	1	1	1	1	1	1	1	1	1	1	1	1	1	1	1	1	1	1	1	1
Nov	1	1	1	1	1	1	1	1	1	1	1	1	1	1	1	1	1	1	1	1	1	1	1	1
Dec	1	1	1	1	1	1	1	1	1	1	1	1	1	1	1	1	1	1	1	1	1	1	1	1

**Weekend Schedule**

	12am	1am	2am	3am	4am	5am	6am	7am	8am	9am	10am	11am	12pm	1pm	2pm	3pm	4pm	5pm	6pm	7pm	8pm	9pm	10pm	11pm
Jan	1	1	1	1	1	1	1	1	1	1	1	1	1	1	1	1	1	1	1	1	1	1	1	1
Feb	1	1	1	1	1	1	1	1	1	1	1	1	1	1	1	1	1	1	1	1	1	1	1	1
Mar	1	1	1	1	1	1	1	1	1	1	1	1	1	1	1	1	1	1	1	1	1	1	1	1
Apr	1	1	1	1	1	1	1	1	1	1	1	1	1	1	1	1	1	1	1	1	1	1	1	1

- Repeat Steps 2-4 for each of the remaining periods that apply to the schedule.

## 20.4.5 Parasitics

The variables on the Parasitics page define electrical loads in the system. For each hour of the simulation, SAM calculates the parasitic load and subtracts it from the power cycle's gross electrical output to calculate the net electrical output.

### Parasitics

#### Non-receiver piping thermal loss coefficient, W/m<sup>2</sup>-K

The thermal loss coefficient that is used to calculate thermal losses from piping between receivers, crossover piping, header piping, and runner piping. The coefficient specifies the number of thermal watts lost from the system as a function of the piping surface area, and the temperature difference between the fluid in the piping and the ambient air (dry bulb temperature). The length of crossover piping depends on the row spacing variable on the [Solar Field](#) page, and the piping distance between assemblies on the [Collectors](#) page.

#### Tracking power in Watts per SCA drive

The amount of electrical power consumed by a single collector tracking mechanism. SAM only calculates tracking losses during hours when collectors are actively tracking the sun. The total field tracking power is calculated by multiplying this value by the number of loops in the field and number of assemblies per loop specified on the [Solar Field](#) page.

#### Pumping power reqeud to move 1 kg of HTF through PB loop, kJ/kg

A coefficient used to calculate the electric power required to pump heat transfer fluid through the power cycle. SAM applies the coefficient to all heat transfer fluid flowing through the power cycle. The

coefficient can alternatively be defined as the pumping power divided by the mass flow rate kW/kg-s, which is equivalent to the units kJ/kg.

#### **Pumping power reqeud to move 1 kg of HTF through TES loop, kJ/kg**

A coefficient used to calculate the electric power consumed by pumps to move heat transfer fluid through the storage heat exchanger on both the solar field side and the storage tank side (for cases where a heat exchanger exists, specified on the [Thermal Storage](#) page). This coefficient is applied separately to the solar field flow and the tank flow.

#### **Fraction of rated gross power constantly consumed**

A fixed electric load applied to all hours of the simulation, expressed as a fraction of rated gross power at design from the [Power Cycle](#) page.

#### **Balance of plant parasitic, MWe/MWcap**

A parasitic load that is applied as a function of the thermal input to the power cycle.

#### **Aux heater, boiler parasitic, MWe/MWcap**

A parasitic load that is applied as a function of the thermal output of the auxiliary fossil-fired heaters. Applies only when the system includes fossil backup. See [the fossil backup inputs on the Power Cycle page](#).

## **Design Point Totals**

The design point total values represent the maximum limit of parasitic losses, and are an estimate of the losses. SAM calculates actual parasitic losses during the simulation and reports them in [time series](#) results with variable names beginning with "Parasitic".

<b>Variable</b>	<b>Equation</b>
Tracking parasitic loss	$= N_{SCA} * N_{loops} * C_{tracking}$
Fixed parasitic loss	$= W_{des,gross} * C_{fixed}$

## **21 CSP Generic Solar**

The generic solar system model allows you to model a system that consists of a solar field, power block with a conventional steam turbine, and optional thermal energy storage system. The model represents the solar field using a set of optical efficiency values for different sun angles and can be used for any solar technology that uses solar energy to generate steam for electric power generation.

## 21.1 Location and Resource

The Location and Resource page provides access to the solar resource library, which is a collection of weather files stored on your computer. When you first install SAM, it comes with a few default weather files in the library. As you use SAM for your own projects, you should add files to build your own library. Once files are in your library, you can use them for different projects and with different versions of SAM.

The screenshot shows the 'Solar Resource Library' window. A green callout bubble points to the table of weather files, stating 'Choose a weather file from the library.' The table lists three files with their respective coordinates and elevations. Another callout bubble points to the list of folders, stating 'List of solar resource folders.' Below the folders, there are buttons for 'Add/remove weather file folders...' and 'Refresh library'. A third callout bubble points to the 'Weather Data Information' section, stating 'Weather file for simulation.' This section displays the selected file path and its header data. A fourth callout bubble points to the 'Annual Averages Calculated from Weather File Data' section, stating 'Information from weather file header.' and 'Summary data calculated from time series data.'

**Solar Resource Library**  
The Solar Resource library is a list of weather files stored on your computer, or use the tools below to add files to the library.

Search for:  Name

Name	Latitude	Longitude	Time zone	Elevation	Station ID
daggett_ca_34.865371_-116.783023_psmv3_60_tmy	34.85	-116.78	-8	561	91486
des_moines_ia_41.586835_-93.624959_psmv3_60_tmy	41.57	-93.62	-6	263	757516
faroo nd 46.9 -96.8 mts1 60 tmy	46.9	-96.8	-6	274	14914

SAM scans the following folders on your computer for valid weather files to add to the Solar Resource library. To use weather files stored on your computer, add folders containing the files.

C:\Users\<user>\SAM Downloaded Weather Files  
F:\little\_rock\_ar  
F:\PVGIS 5

Add/remove weather file folders...  
Refresh library

**Weather Data Information**  
The following information describes the weather file selected from the Solar Resource library above. This is the file SAM will use when you click Simulate.

Weather file: C:\SAM\2018.10.29\solar\_resource\daggett\_ca\_34.865371\_-116.783023\_psmv3\_60\_tmy.csv

**Header Data from Weather File**

City	Station ID: 91486	Latitude: 34.85 °N
State	Data Source: NSRDB	Longitude: -116.78 °E
Country	Elevation: 561 m	Time zone: GMT -8

**Annual Averages Calculated from Weather File Data**

Global horizontal	NaN kWh/m <sup>2</sup> /day	Average temperature	17.3 °C
Direct normal (beam)	7.65 kWh/m <sup>2</sup> /day	Average wind speed	2.4 m/s
Diffuse horizontal	1.27 kWh/m <sup>2</sup> /day		

\*NaN indicates missing data.

There are two ways to add files to your solar resource library:

### 1. Download files from the NREL National Solar Radiation Database (NSRDB)

Use the download weather file options and click **Download and add to library** to get the most up-to-date data from the NSRDB for long-term cash flow analysis, single-year analysis, and P50/P90 analysis.

### 2. Add weather file folders

If you have weather files from a source other than the NSRDB or that you've downloaded yourself directly from the NSRDB website, click **Add/remove weather file folders** to add the folder containing the files to the **Solar Data File Folders** list. SAM automatically adds any weather files it finds in these folders to the solar resource library so they will appear in the list.

When you install SAM, it creates the default download folder <user>/SAM Downloaded Weather Files



folder where weather files you download from the NSRDB are stored. You can change that folder by clicking **Add/remove weather file folders** and changing the **Folder for Downloaded Solar Data Files**.

For locations not in the NSRDB, you can download weather files in the EPW format from the European Commission Photovoltaic Geographical Information System [PVGIS V5 website](#).

## See also

[Weather File Formats](#)

[Weather Data Elements](#)

[Typical and Single Year](#)

[Time and Sun Position](#)

[Folders and Libraries](#)

[Weather Data and LK](#)

### Notes.

You may want to model your system using weather data from several different sources and locations around your project site to understand how sensitive your analysis results are to the weather assumptions, and how much variation there is in the data from the different weather files.

You can compare results for a system using more than one weather file in a single case by using SAM's [parametric simulation](#) option.

For more information about weather data, including where to find data for locations outside of the United States, see [Weather Data](#) on the SAM website.

For a helpful discussion of weather data and power system simulation, see Sengupta, M.; Habte, A.; Gueymard, C.; Wilbert, S.; Renne, D.; Stoffel, T. (2017). "Best Practices Handbook for the Collection and Use of Solar Resource Data for Solar Energy Applications: Second Edition." NREL Report No. TP-5D00-68886. ([PDF 8.1 MB](#))

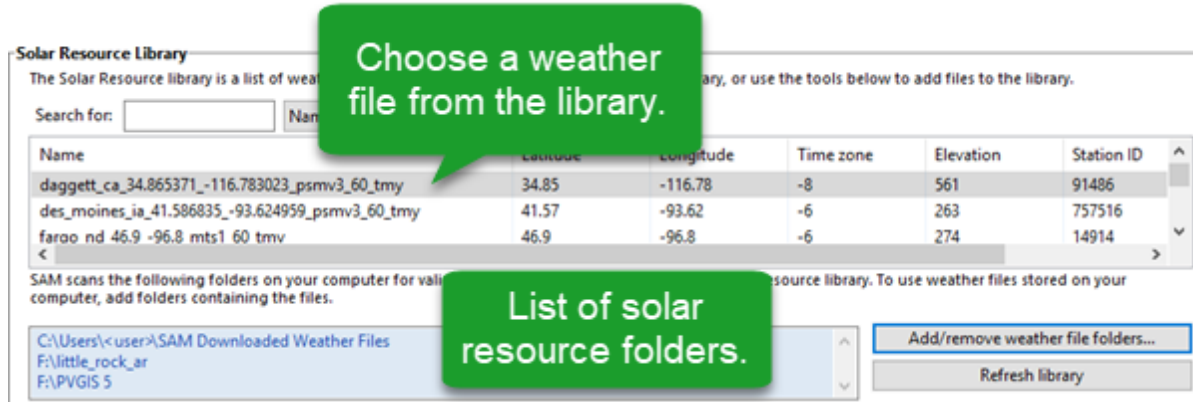
## ▼ Solar Resource Library

SAM's solar resource library displays information from weather files in your solar resource data folders. The default solar resource library that comes with SAM contains weather files for a few locations around the United States for the default configurations. As you use SAM, use **Add/remove weather file folders** to build a library of files for locations you frequently use as described in [Folders and Libraries](#).

### **To choose a file from the solar resource library:**

- Click the location name in the list. You can type a few letters of the file name in the Search box to filter the list.

The full file name and information about the selected file appears under **Weather Data Information**. To see the data in the file, click **View data**.



### Add/remove weather file folders

Use the folder settings to tell SAM what folders on your computer it should scan for weather files to build the solar resource library. SAM adds any files it can identify as valid weather files in each folder you specify to the library.

Before adding a file to the library, SAM checks the data in the file displays a message if it finds any problems with the data in the file.

SAM will only add valid weather files to the library. If you add a folder that contains CSV files that are not in the SAM CSV format, it will not add those files to the library.

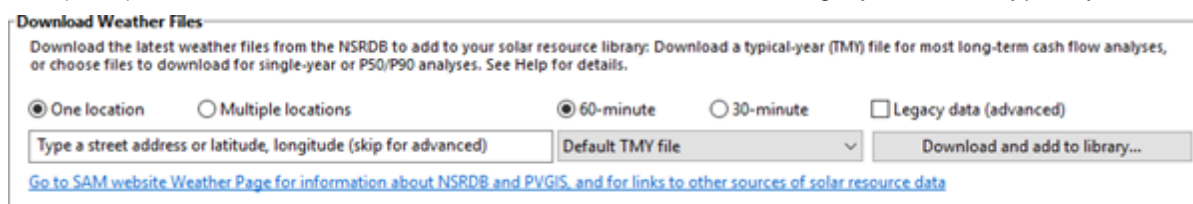
The list of solar resource folders are the folders that SAM scans for weather files to build the solar resource library.

### Refresh library

Refresh the library after adding files to the weather file folder. In most cases, SAM should automatically refresh the library as needed, but you may need to manually refresh it.

## Download Weather Files

SAM can download weather files from the latest National Solar Radiation Database (NSRDB) Physical Solar Model (PSM) datasets. For all NSRDB datasets, SAM can download single-year files or typical-year files.



**Note.** For locations not in the NSRDB, you can download EPW files from the European Commission Photovoltaic Geographical Information System [PVGIS V5 website](#) to a folder on your computer, and then use the [folder settings window](#) to add the folder to the list of folders SAM scans to build the solar resource library.

### To download a typical-year weather file for a single location:

1. Replace the text "Type a location name, street address or latitude and longitude" with a street address, city and state or country name, zip code, or latitude longitude pair. For example:

- Golden, Colorado
  - golden, co
  - 15013 Denver West Parkway, Golden CO 80401
  - 80401
  - thimpu, bhutan
2. Click **Download and add to library**.

For more instructions to download multiple files, see [Weather File Download Instructions](#) below.

SAM converts the address you type to a latitude and longitude pair for the location, and submits that information to the NSRDB along with your email address. If the location is in the region covered by the NSRDB, it returns a weather file in the SAM CSV format, and adds it to your weather file download folder. Otherwise, it displays a message telling you the location is not covered by the NSRDB.

When you first install SAM, it creates the *SAM Downloaded Weather Files* folder and assigns it as your weather file download folder. You can change the weather file download folder by clicking **Add/Remove weather file folders**. See [Folders and Libraries](#) for details.

When the download finishes, SAM displays a prompt asking you if you want to open the weather file download log. This prompt is the indication that the download finished. During the download and before that prompt appears, SAM may become unresponsive. If it does, wait for the prompt to avoid interrupting the download.

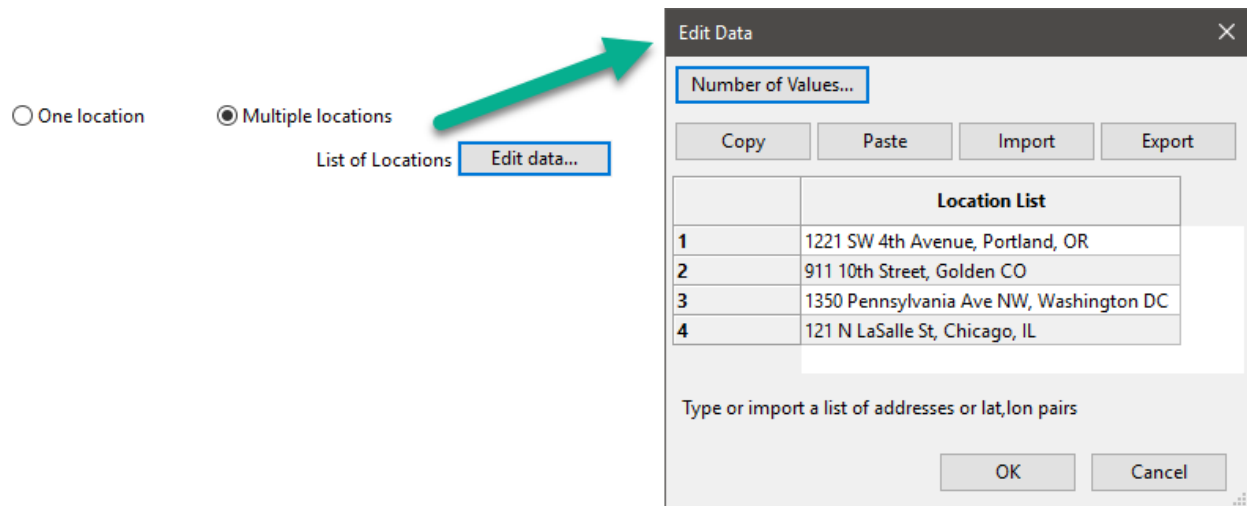
The weather file download log is a text file that SAM creates in your weather file download folder, and serves as a record of all of the files you download from the NSRDB. For each download, it lists the date and time of the request, the information you provided, the URL SAM generated, the name of the file returned by the NSRDB, or error messages it returns if the download fails. This information is useful for troubleshooting weather file download problems.

**Note.** Downloading multiple weather files from the NSRDB can take a long time. If you download files for multiple locations or years, be prepared to wait for the files to download. The download log file reports the time it takes for each file to download. Download times depend on your internet connection and computer. For a new computer with a fast connection, downloading and processing a single file takes about 10 seconds.

### One location, Multiple locations

Choose **One location** to download a weather file for a single location.

Choose **Multiple locations** to submit a list of locations and download a file or files for each location. For Multiple locations, click **Edit data** to open the Edit Data window where you can enter the list of locations and click **Number of Values** to enter the number of locations in the list.

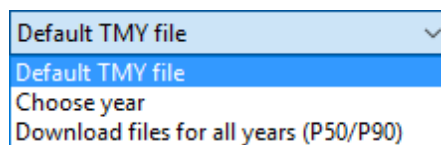


### 60-minute, 30-minute

Choose **60-minute** to download weather files with hourly time steps or 8,760 data records.

Choose **30-minute** to download files with 30-minute time steps or 17,520 data records. Thirty-minute data is not available for the NSRDB SUNY International dataset.

### Download options



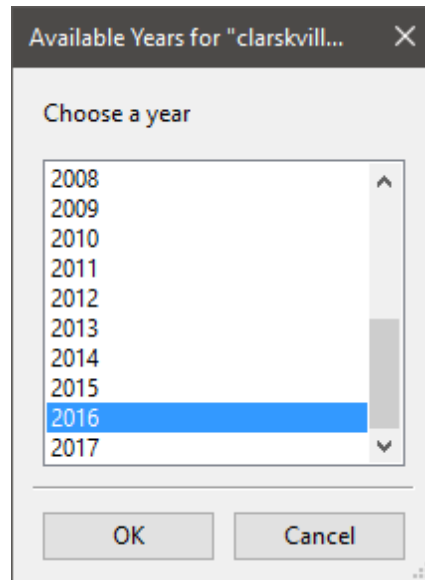
### Default TMY file

Download a typical meteorological year weather file for the location or locations you specified.

Typical year data is appropriate when you are using simulation results for a single year to make cash flow calculations over a multi-year period.

### Choose year

Choose a single year file to download. After you click the Download button, SAM prompts you with a list of available years for each location you requested to choose a year.



The single year option is appropriate when you want to see how the system would perform in a particular year. For example, for a residential or commercial system, if you have measured building load data for a given year, you could use weather data for the same year to see how the system's power output compares to the load.

If you use both **Choose year** and **Multiple locations**, SAM prompts you for a year for each location.

SAM queries the NSRDB to generate the list of available years. The list of available years varies between regions.

### Download files for all years (P50/P90)

Download a set of single-year files covering the range of historical data (nineteen files for 1998 through 2017 as of October 2018 for PSM data). When you click download, SAM creates a folder in your weather file download folder to store the single year files based on the location address or latitude-longitude pair you typed. It also downloads the typical meteorological year (TMY) file for the location and stores it in your weather file download folder.

SAM appends an underscore with the year to the file name so that the P50 P90 simulations work correctly. See [P50/P90 Simulations](#) for details.

If you choose to download files for all years with **Multiple locations**, SAM downloads a set of files for each location, and puts the files for each location in a separate folder. Note that this may take a long time.

## Weather File Download Instructions

### Examples of valid street address or latitude-longitude pairs:

- golden colorado
- golden, co
- 15013 Denver West Parkway, Golden CO 80401
- 80401
- 39.75, -105.15

- Super Market, F-6 Markaz, Islamabad, Pakistan
- New Delhi, India

**Note.** When the download finishes, SAM displays a prompt asking you if you want to open the weather file download log. This prompt is the indication that the download finished. During the download and before that prompt appears, SAM may become unresponsive. If it does, wait for the prompt to avoid interrupting the download.

**To download an hourly typical-year (TMY) weather file from the NSRDB (use this option for most situations):**

1. Click **One location**.
2. Type either a street address or latitude-longitude pair.
3. Click **60-minute**.
4. Choose **Default TMY File**.
5. Click **Download and add to library**.

**To download files for more than one location:**

1. Click **Multiple locations**.
2. Click **Edit data**.
3. In the Edit Data window, click **Number of Values** and type the number of locations to create a table with a row for each location.
4. Type a street address or latitude-longitude pair in the table for each location.
5. Click **OK**.
6. Choose a time step, **60-minute** for hourly, or **30-minute** for 30-minute data.
7. Choose the type of file(s) you want to download as described below.
8. Click **Download and add to library**.

## Weather Data Information

**Weather Data Information**  
The following information describes the weather file selected from the Solar Resource library above. This is the file SAM will use when you click Simulate.

Weather file:  [View data](#)

**Header Data from Weather File**

City	<input type="text" value="-"/>	Station ID	<input type="text" value="91486"/>	Latitude	<input type="text" value="34.85 *N"/>
State	<input type="text" value="-"/>	Data Source	<input type="text" value="NSRDB"/>	Longitude	<input type="text" value="-116.78 *E"/>
Country	<input type="text" value="-"/>	Elevation	<input type="text" value="561 m"/>	Time zone	<input type="text" value="GMT -8"/>

**Annual Averages Calculated from Weather File Data**

Global horizontal	<input type="text" value="NaN"/>	kWh/m <sup>2</sup> /day	Average temperature	<input type="text" value="17.3"/>	°C	- Optional Data
Direct normal (beam)	<input type="text" value="7.65"/>	kWh/m <sup>2</sup> /day	Average wind speed	<input type="text" value="2.4"/>	m/s	Maximum
Diffuse horizontal	<input type="text" value="1.27"/>	kWh/m <sup>2</sup> /day	*NaN indicates missing data.			

### Weather File

The path and name of the active weather file SAM will use for simulation. Download a different file from the NSRDB, or click a different file name in the library to change the file.

### View data

Display weather file data in the [time series data viewer](#).

**Note.** You can also see the data after running a simulation on the Results page [data tables](#) and [time series graphs](#).

### Header Data from Weather File

Header data is information in the weather file that describes the location and type of data in the file. SAM uses the time zone, elevation, latitude and longitude to calculate the sun position during simulations. It does not use the city, state, country, and other descriptive information.

### Annual Values Calculated from Weather File

When you add a weather file to the solar resource library, SAM reads weather data from the file and calculates the annual values to display for your reference. It does not use annual values during simulations.

#### Global horizontal, Direct normal (beam), Diffuse horizontal

The sum of solar irradiance data (W/m<sup>2</sup>) in the weather file converted to kW and divided by 365 days/year.

#### Average temperature

The sum of temperature data (°C) in the weather file divided by the number of records in the file (8760 for hourly data).

#### Average wind speed

The sum of wind speed data (m/s) in the weather file divided by the number of records in the file (8760 for hourly data).

### Maximum snow depth

If the weather file contains snow depth data, the maximum value of snow depth data (cm) in the weather file. NaN indicates the file does not contain snow depth data. Snow depth data is required for to model snow losses for the Detailed Photovoltaic and PVWatts models.

**Note.** For information about where to find weather files with snow depth data, see the note on the [Weather Data](#) page of the SAM website.

### Annual albedo

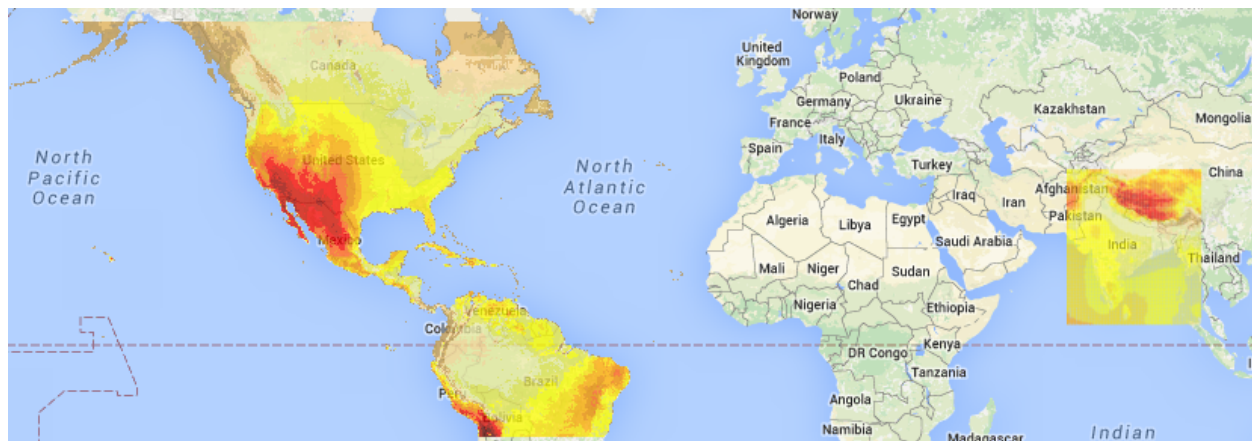
If the weather file contains albedo (ground reflectance) data, the average value of albedo values in the weather file. NaN indicates the file does not contain albedo data.

## ▼ About the NSRDB

The [NREL National Solar Radiation Database \(NSRDB\)](#) is an online database of weather files containing solar resource data in the [SAM CSV format](#). Files are available both as [typical-year](#) files and [single-year](#) files. The database covers the parts of the Americas and Asia shown in the map below. The current data is called PSM (Physical Solar Model) for the U.S., and SUNY for Asia. For details about the data see these pages on the NSRDB website:

- [U.S. data](#)
- [International data](#)

The NSRDB also contains legacy datasets for the U.S. from older versions of the NSRDB, including MTS3 (TMY3 1991-2010), MTS2 (TMY3 1991-2005), and MTS1 (TMY2 1961-1990). We recommend that you use the latest PSM data for your work in SAM, but the older data is available if you need it.



**Important Note for CSP Modelers!** SAM's CSP models assume that each DNI value in the weather file represents the average irradiance over the time step, and calculate sun angles for the midpoint of the time step. In weather files from the NSRDB, the irradiance data is measured instantaneously at either the beginning of the hour (TMY data), midpoint of the hour (single-year data), or beginning of the 30-minute time step (30-minute single-year data). As a result, if you use an NSRDB PSM weather file with a CSP model with either hourly TMY data or 30-minute single-year data, the sun angle for each time step will be for a different time than the time for the instantaneous irradiance values. See [Time Convention and Sun Position](#) for details.



**Notes.**

The NSRDB requires an email address to download weather file. When you download a weather file from SAM, SAM submits the email address that you used to [register SAM](#). NREL uses your email address to determine how many people are using the NSRDB. It does not share email addresses.

Different types of weather files in the NSRDB use different time conventions. See [Time Convention and Sun Position](#) for details.

When you download a file from the NSRDB website, SAM displays a "-" for the City, State, and Country fields because the NSRDB files do not contain that information. This will not affect simulation results. The location information SAM requires for simulations is latitude, longitude, elevation and time zone.

SAM uses the [Google Maps API Geocoding Service](#) service to identify the geographic coordinates (latitude and longitude) of a location when you type a street address or city and state name to identify the location.

For information about downloading weather files and data from other sources, see the [Weather Data](#) page on the SAM website.

SAM downloads weather files with the following hourly data from the NSRDB:

- Direct normal (beam) irradiance, DNI ( $W/m^2$ )
- Diffuse horizontal irradiance, DHI ( $W/m^2$ )
- Dry-bulb temperature ( $^{\circ}C$ )
- Dew-point temperature ( $^{\circ}C$ )
- Relative humidity (%), for single-year files only
- Atmospheric pressure (mbar)
- Wind speed at 2 meters above the ground (m/s)
- Wind direction ( $^{\circ}E$  of N)
- Albedo

**Note.** Weather files with snow depth data for the Detailed Photovoltaic model are not available from the NSRDB PSM dataset. They are available for 239 locations in the United States from the legacy [MTS1 \(TMY2\) files in the original format](#), which cover the period 1961 - 1990. See [Snow Losses](#) for details.

## 21.2 Solar Field

### Solar Field Optical Efficiency Data

The solar position table option allows you to specify optical efficiency of the solar field as a function of solar azimuth and zenith angles. SAM uses a solar azimuth angle convention where true North is equal to -180/

+180° and South equals 0°. The solar zenith angle is zero when the sun is directly overhead and 90° when the sun is at the horizon.

The solar position may contain any number of rows and columns, but should contain enough information to fully define the performance of the solar field at all sun positions for which the field will operate. The table must contain more than one row and column.

SAM uses linear interpolation to estimate efficiency values for solar positions between those specified on the table.

### Import

Import a table from a text or data file. The file can contain values separated by comma, space, or tab characters, but must be formatted according to the following rules:

- The first row in the file specifies the angles for the solar azimuth (for the Solar position table) or collector transversal incidence (for the Collector incidence angle table). The first entry of this row should be blank.
- Each additional row specifies optical efficiency for a specific zenith angle (for the Solar position table) or longitudinal incidence angle (for the Collector incidence angle table). The first entry of the row must be the zenith or longitudinal incidence angle corresponding to the optical efficiency entries in that row.
- The rows of the table should be sorted according to zenith/longitudinal incidence angle from lowest to highest.

An example tab-delimited table is as follows, where numbers in bold correspond to the solar zenith (row headers) and azimuth (column headers) angles:

	<b>-180</b>	<b>-90</b>	<b>0</b>	<b>90</b>	<b>180</b>
<b>0</b>	1.0	1.0	1.0	1.0	1.0
<b>30</b>	0.95	0.98	0.99	0.98	0.95
<b>60</b>	0.60	0.70	0.75	0.70	0.60
<b>90</b>	0.0	0.0	0.0	0.0	0.0

Note that SAM automatically sizes the table on the Collector and Receiver page to match the size of the array that is being imported.

### Export

Export the optical efficiency table on the Collector and Receiver page to a text file.

### Copy

Copy the optical efficiency table on the Collector and Receiver page to the clipboard for transfer to an optical efficiency table in another case or to other text applications.

### Paste

Paste an optical efficiency table from another SAM case or from a text file into the active case.

### Rows

Specify the number of desired rows in the table.

### Cols

Specify the number of desired columns in the table.

**Interpolate table**

Choose this option if you want SAM to use interpolation to calculate radiation values for points between those included in the table.

**Irradiation basis**

Determines the column of data that SAM reads from the weather file.

**Unsorted data table mode**

This option allows you to specify the solar field efficiency using a table of Sun Azimuth-Zenith pairs. SAM uses the Gauss-Markov method to interpolate efficiency values over the full range of sun positions.

**Design Point Parameters****Solar Multiple**

The field aperture area expressed as a multiple of the aperture area required to operate the power cycle at its design capacity. See Sizing the Solar Field for details.

**Solar field design output (MWt)**

The thermal energy delivered by the solar field under design conditions at the given solar multiple. This value is calculated in the interface as the function of the solar multiple, the Reference conversion efficiency on the Power Block page, and the Design gross output on the Power Block page, as follows:

$$Q_{sf,des} = \frac{W_{pb,des}}{\eta_{des}} \cdot SM$$

**Ambient temp at design (°C)**

The design point ambient temperature (dry-bulb), used to calculate solar field thermal efficiency and the aperture area required to drive the power cycle at its design capacity.

**Solar resource at design (W/m<sup>2</sup>)**

The design point direct normal radiation value, used in solar multiple mode to calculate the aperture area required to drive the power cycle at its design capacity.

**Stow angle (degrees)**

The collector angle during the hour of stow. A stow angle of zero for a northern latitude is vertical facing east, and 180 degrees is vertical facing west. Default is 170 degrees.

**Deploy angle (degrees)**

The collector angle during the hour of deployment. A deploy angle of zero for a northern latitude is vertical facing due east. Default is 10 degrees.

**Estimated Solar Field Area (m<sup>2</sup>)**

The total solar energy collection area of the solar field in square meters.

$$\text{Estimated Solar Field Area} = \left( \text{Solar Field Design Output} + \text{Thermal Loss at Design} \right) \\ / \text{Total Optical Efficiency} \times 1,000,000 \\ / \text{Solar Resource at Design}$$

**Efficiency Derates****Peak optical efficiency**

The maximum value of the optical efficiency values in the Solar Field Optical Efficiency Data table.

**Cleanliness factor**

A derating factor to account for optical losses by soiling on the mirror surface or other losses.

**General optical derate**

Accounts for reduction in absorbed radiation caused by general optical errors or other unaccounted error sources.

**Total optical efficiency**

The product of the three optical efficiency factors.

**Solar Field Availability**

The [Edit Losses](#) window allows you to specify fixed, hourly, and/or hourly losses within custom periods. Losses effectively reduce (or increase) the optical efficiency of the solar field during the affected hour(s).

**Generalized Thermal Losses****Reference thermal loss fraction**

The fraction of thermal power generated by the solar field that is lost to thermal losses at design. The heat loss calculation during the annual hourly performance run multiplies this value by the resulting values of the heat loss correction polynomials to obtain the total solar field thermal efficiency. The thermal losses from the solar field are evaluated according to the following relationship, where the various  $F_{hl}$  coefficients are evaluated according to the descriptions provided below.

$$F_{hl,sf} = 1 - F_{hl,sf,ref} \cdot (F_{hl,lb_n} + F_{hl,T_{amb}} + F_{hl,V_{wind}})$$

$$\dot{Q}_{hl} = (1 - F_{hl,sf}) \cdot \dot{Q}_{sf,des}$$

**Irradiation thermal loss adjustment**

This polynomial adjusts the thermal loss fraction in the solar field as a function of the solar irradiation available during the current time step of the performance simulation. The polynomial is evaluated to determine the sensitivity of thermal losses to irradiation as follows:

$$F_{hl,lb_n} = C_0 + C_1 \cdot \left( \frac{I_{bn}}{I_{bn,des}} \right) + C_2 \cdot \left( \frac{I_{bn}}{I_{bn,des}} \right)^2 + C_3 \cdot \left( \frac{I_{bn}}{I_{bn,des}} \right)^3$$

where  $I_{bn}$  is the solar irradiation during the current time step and  $I_{bn,des}$  is the design-point solar irradiation from the Solar resource at design input on the Solar Field page.

**Ambient temp thermal loss adjustment**

This polynomial adjusts the thermal loss fraction in the solar field as a function of the ambient dry-bulb temperature in degrees Celsius. The Reference thermal loss fraction is multiplied by the result of the following polynomial:

$$F_{hl,T_{amb}} = C_0 + C_1 \cdot \Delta T_{amb} + C_2 \cdot \Delta T_{amb}^2 + C_3 \cdot \Delta T_{amb}^3$$

where

$$\Delta T_{amb} = T_{amb} - T_{amb,des}$$

or the ambient temperature for the current time step of the simulation minus the ambient dry-bulb temperature at design.

### Wind speed thermal loss adjustment

This polynomial adjusts the thermal loss fraction in the solar field as a function of the wind speed during the current time step of the performance simulation. The result of the evaluated wind speed adjustment polynomial multiplies the Reference thermal loss fraction and other correction polynomials to determine the total solar field efficiency. The polynomial is evaluated as follows:

$$F_{hl,V_{wind}} = C_0 + C_1 \cdot V_{wind} + C_2 \cdot V_{wind}^2 + C_3 \cdot V_{wind}^3$$

where

$$\Delta T_{amb} = T_{amb} - T_{amb,des}$$

### Thermal loss at design

The calculated thermal losses at design conditions, equal to the product of the **Reference thermal loss fraction** and the **Solar field design output**. SAM calculates actual thermal losses during simulation runs using on the design-point thermal losses and the results of the thermal loss correction polynomials described above. The design thermal losses are used to size the aperture area of the solar field that is required to drive the power cycle.

## 21.3 Power Block

### Capacity

#### Design gross output (MWe)

The power cycle's design output, not accounting for parasitic losses. SAM uses this value to size system components, such as the solar field area when you use the solar multiple to specify the solar field size.

#### Estimated gross to net conversion factor

An estimate of the ratio of the electric energy delivered to the grid to the power cycle's gross output. SAM uses the factor to calculate the system's nameplate capacity for capacity-related calculations.

#### Estimated net output at design (MWe)

The power cycle's nominal capacity, calculated as the product of the design gross output and estimated gross to net conversion factor. SAM uses this value for capacity-related calculations, including the estimated total cost per net capacity value on the System Costs page, capacity-based incentives on the Cash Incentives page, and the capacity factor reported in the results.

$$\text{Estimated Net Output at Design (MWe)} = \text{Design Gross Output (MWe)} \times \text{Estimated Gross to Net Conversion Factor}$$

### System Availability

System availability losses are reductions in the system's output due to operational requirements such as maintenance down time or other situations that prevent the system from operating as designed.

**Note.** To model curtailment, or forced outages or reduction in power output required by the grid operator, use the inputs on the [Grid Limits](#) page.

To edit the system availability losses, click **Edit losses**.

The [Edit Losses](#) window allows you to define loss factors as follows:

- Constant loss is a single loss factor that applies to the system's entire output. You can use this to model an availability factor.
- Hourly losses apply to specific hours of the year.

SAM reduces the system's output in each hour by the loss percentage that you specify for that hour. For a given hour, a loss of zero would result in no adjustment. A loss of 5% would reduce the output by 5%, and a loss of -5% would increase the output value by 5%. For subhourly simulations, SAM applies the loss factor for a given hour to each time step in that hour

## Conversion

**Note.** The generic solar system model's steam turbine model is based on the empirical parabolic trough model's power block model. For a description of how SAM uses the part-load and temperature adjustment coefficients, see [Power Block Simulation Calculations](#).

### Reference conversion efficiency

Total thermal to electric efficiency of the reference turbine at design. Used to calculate the design turbine thermal input and required solar field aperture area.

### Max over design operation

The turbine's maximum output expressed as a fraction of the design turbine thermal input. Used by the dispatch module to set the power block thermal input limits. In cases where the normalized thermal power delivered to the power block by the solar field exceeds this fraction, the field will dump excess energy.

### Minimum load

The turbine's minimum load expressed as a fraction of the design turbine thermal input. Used by the dispatch module to set the power block thermal input limits. In cases where the solar field, thermal storage, and/or fossil backup system are unable to produce enough energy to meet this fractional requirement, the power cycle will not produce electricity.

### Power cycle startup energy

Hours of equivalent full-load operation of the power cycle required to bring the system to operating temperature after a period of non-operation. Used by the dispatch module to calculate the required start-up energy.

### Boiler LHV Efficiency

The back-up boiler's lower heating value efficiency. Used by the power block module to calculate the quantity of gas required by the back-up boiler.

### Power cycle design ambient temperature

The ambient temperature at which the power cycle conversion efficiency is equal to the reference conversion efficiency. The temperature corresponds to either the wet-bulb or dry-bulb temperature, depending on the value selected by the user in the Temperature correction mode list. The temperature is used in the Temperature adjustment polynomial in the Parasitics group on the Power Block page to determine cycle conversion efficiency.

### Part load efficiency adjustment

Coefficients for the turbine thermal-to-electric efficiency polynomial equation. This polynomial is used to adjust the cycle conversion efficiency as the thermal load into the power cycle varies from its design-point value. The resulting value from the evaluated polynomial multiplies the reference conversion efficiency, where the polynomial is formulated as follows:

$$F_{\eta,load} = C_0 + C_1 \cdot \left( \frac{Q_{pb}}{Q_{pb,des}} \right) + C_2 \cdot \left( \frac{Q_{pb}}{Q_{pb,des}} \right)^2 + C_3 \cdot \left( \frac{Q_{pb}}{Q_{pb,des}} \right)^3 + C_4 \cdot \left( \frac{Q_{pb}}{Q_{pb,des}} \right)^4$$

### Temperature efficiency adjustment

Factors for polynomial equation adjusting power cycle efficiency based on the difference between the power cycle design temperature and ambient temperature (either wet bulb or dry bulb temperature from the weather file, depending on the option you choose for Temperature Correction Mode.) The polynomial is formulated as follows:

$$F_{\eta,temp} = C_0 + C_1 \cdot (T_{amb} - T_{pb,des}) + C_2 \cdot (T_{amb} - T_{pb,des})^2 + C_3 \cdot (T_{amb} - T_{pb,des})^3 + C_4 \cdot (T_{amb} - T_{pb,des})^4$$

where  $T_{amb}$  is the wet or dry bulb temperature, depending on the **Temperature Correction Mode** selection.

The power cycle conversion efficiency  $\eta_{cycle}$  is calculated as the product of the Reference conversion efficiency  $\eta_{cycle,ref}$  and the summation of the two polynomial efficiency adjustment terms.

$$\eta_{cycle} = \eta_{cycle,ref} \cdot (F_{\eta,load} + F_{\eta,temp})$$

### Temperature Correction Mode

In the dry bulb mode, SAM calculates a temperature correction factor to account for cooling tower losses based on the ambient temperature from the weather data set. In wet bulb mode, SAM calculates the wet bulb temperature from the ambient temperature and relative humidity from the weather data.

## Parasitics

### Fixed parasitic load (MWe/MWcap)

A fixed hourly loss calculated as a fraction of the power block nameplate capacity.

### Production based parasitic (MWe/MWe)

A variable hourly loss calculated as a fraction of the system's hourly electrical output. The total production-based parasitic is evaluated as follows:

$$\dot{W}_{par,prod} = \dot{W}_{gross,des} \cdot F_{par,prod,ref} \cdot (F_{par,load} + F_{par,temp} + F_{par,DNI})$$

where  $F_{par,prod,ref}$  is the production based parasitic factor,  $F_{par,load}$  is the load-based parasitic adjustment factor (defined below), and  $F_{par,temp}$  is the temperature-based parasitic adjustment factor (also defined below), and  $F_{par,DNI}$  is the solar resource-based parasitic adjustment factor (also defined below).

**Part load adjustment**

Coefficients for a polynomial that adjusts the parasitic consumption as a function of power cycle gross power output. The result of the polynomial is denoted as  $F_{par,load}$  in the Production based parasitic description above.

**Temperature adjustment**

Coefficients for a polynomial that adjusts the parasitic consumption as a function of the difference between ambient temperature and the reference power cycle ambient temperature. The result of the polynomial is denoted as  $F_{par,temp}$  in the Production based parasitic description above.

**DNI adjustment**

Coefficients for a polynomial that adjusts the parasitic consumption as a function of the solar resource value. The result of the polynomial is denoted as  $F_{par,DNI}$  in the Production based parasitic description above.

## 21.4 Thermal Storage

### Thermal Energy Storage (TES)

**Full Load Hours of TES**

The thermal storage capacity expressed in number of hours of thermal energy delivered at the power block's design thermal input level. The physical capacity is the number of hours of storage multiplied by the power block design thermal input. Used to calculate the TES maximum storage capacity.

**Max thermal capacity (MWh)**

The maximum thermal energy storage capacity of the TES, assuming that thermal storage can be fully discharged (see Thermal Storage Dispatch Control).

**Charging energy derate**

SAM applies the derate factor to the turbine efficiency for trough systems with storage to account for the lower steam temperature that results from imperfect heat exchange in the storage system.

**Discharging energy derate**

Efficiency adjustment factor. Used to calculate maximum TES discharge rate.

**Initial charge fraction**

The initial charge fraction specifies the fractional state of charge in thermal storage at the initial time step of the simulation. A fraction of 0 indicates no thermal energy stored, while a fraction of 1 indicates full state of charge.

**Thermal loss multiplier (kWt/MW-hr-cap)**

The thermal loss multiplier specifies the baseline rate of heat loss in kWt from storage per MW-hr of thermal energy capacity for the storage system. For example, a value of 0.35 kWt/MW-hr-cap on a plant with 1,000 MW-hr of storage capacity corresponds to a baseline heat loss of 350 kWt. The heat loss may be altered according to the state of charge and ambient temperature, as described below.



**Charge based loss adj**

Coefficients for evaluating a polynomial equation that adjust thermal losses from the thermal storage system based on charge level. The polynomial is formulated as follows:

$$F_{hl,tes,charge} = C_0 + C_1 \cdot X_{charge} + C_2 \cdot X_{charge}^2 + C_3 \cdot X_{charge}^3$$

where  $X_{charge}$  is the fractional charge level of the thermal storage system. The fractional charge is evaluated at the average charge level over the time step.

**Temp based loss adj**

Coefficients for evaluating a polynomial equation that adjust thermal losses from the thermal storage system based on ambient temperature. The polynomial is formulated as follows:

$$F_{hl,tes,temp} = C_0 + C_1 \cdot (T_{sf,des} - T_{db}) + C_2 \cdot (T_{sf,des} - T_{db})^2 + C_3 \cdot (T_{sf,des} - T_{db})^3$$

where  $T_{sf,des}$  is the design-point solar field ambient temperature defined on the Solar Field page.

The total thermal loss from thermal storage is calculated as the product of the Thermal loss multiplier  $F_{hl,ref}$  the capacity of the thermal storage system  $E_{TES,cap}$ , and the sum of the evaluated loss adjustment polynomials.

$$\dot{Q}_{hl,tes} = F_{hl,ref} \cdot E_{TES,cap} \cdot (F_{hl,tes,charge} + F_{hl,tes,temp})$$

**Charge based exergy adj**

The charge-based exergy adjustment factor allows you to modulate the exergetic state of energy that is discharged from thermal storage as a function of the state of charge in thermal storage. Either a single value or a table of values may be specified. The exergy penalty may be applied using either a “direct storage” or “indirect storage” configuration. The exergy adjustment affects the power cycle conversion efficiency in the following manner:

$$\eta_{cycle} = \eta_{cycle,des} \cdot \left( \frac{\eta'_{cycle}}{\eta_{cycle,des}} + F_{exergy} - 1 \right)$$

Where  $\eta_{cycle,des}$  is the design-point cycle conversion efficiency,  $\eta'_{cycle}$  is the calculated cycle efficiency before exergy adjustment is applied, and  $F_{exergy}$  is the exergetic correction factor. This factor is determined as follows:

- If a single value is specified, that value is always used
- If a table is specified, the exergetic penalty is determined by interpolating the state of charge and returning the corresponding exergetic penalty.

If the “direct storage” option is enabled, all energy sent to the power cycle is adjusted in this way. If the “indirect storage” option is enabled, energy coming from the solar field is first sent to the power cycle (as available) and incurs no penalty, and only supplemental energy coming from thermal storage is penalized.

**Thermal Storage Dispatch Control**

The storage dispatch control variables each have six values, one for each of six possible dispatch periods. They determine how SAM calculates the energy flows between the solar field, thermal energy storage system, and power block. The fossil-fill fraction is used to calculate the energy from a backup boiler.

### Storage Dispatch Fraction with Solar

The fraction of the TES maximum storage capacity indicating the minimum level of charge that the storage system can discharge to while the solar field is producing power. A value of zero will always dispatch the TES in any hour assigned to the given dispatch period; a value of one will never dispatch the TES. Used to calculate the storage dispatch levels.

### Storage Dispatch Fraction without Solar

The fraction of the TES maximum storage capacity indicating the minimum level of charge that the storage system can discharge to while no solar resource is available. A value of zero will always dispatch the TES in any hour assigned to the given dispatch period; a value of one will never dispatch the TES. Used to calculate the storage dispatch levels.

### Turbine Output Fraction

The fraction of design-point thermal load to the power block before part-load and temperature efficiency corrections. These values allow the user to dispatch the power cycle at a desired level according to the time-of-dispatch period.

### Fossil Fill Fraction

A fraction of the power block design turbine gross output from the Power Block page that can be met by the backup boiler. Used by the power block module to calculate the energy from the backup boiler.

If you specify a fossil fill fraction other than zero for one or more periods and want to account for fuel costs in the financial model, you should assign a fossil fuel cost under Operation and Maintenance costs on the [System Costs](#) page.

## Storage and Fossil Dispatch Controls

The thermal storage dispatch controls determine the timing of releases of energy from the thermal energy storage and fossil backup systems to the power block. When the system includes thermal energy storage or fossil backup, SAM can use a different dispatch strategy for up to six different dispatch periods.

### Storage Dispatch

SAM decides whether or not to operate the power block in each hour of the simulation based on how much energy is stored in the TES, how much energy is provided by the solar field, and the values of the thermal storage dispatch controls parameters. You can define when the power block operates for each of the six dispatch periods. For each hour in the simulation, if the power block is not already operating, SAM looks at the amount of energy that is in thermal energy storage at the beginning of the hour and decides whether it should operate the power block. For each period, there are two targets for starting the power block: one for periods of sunshine (w/solar), and one for period of no sunshine (w/o solar).

The turbine output fraction for each dispatch period determines at what load level the power block runs using energy from storage during that period. The load level is a function of the turbine output fraction, design turbine thermal input, and the five turbine part load electric to thermal factors on the [Power Block page](#).

For each dispatch period during periods of sunshine, thermal storage is dispatched to meet the power block load level for that period only when the thermal power from the solar field is insufficient and available storage is equal to or greater than the product of the storage dispatch fraction (with solar) and maximum energy in storage. Similarly, during periods of no sunshine when no thermal power is produced by the solar field, the power block will not run except when the energy available in storage is equal to or greater than the product of storage dispatch fraction (without solar) and maximum energy in storage.

By setting the thermal storage dispatch controls parameters, you can simulate the effect of a clear day when the operator may need to start the plant earlier in the day to make sure that the storage is not filled to capacity and solar energy is dumped, or of a cloudy day when the operator may want to store energy for later use in a higher value period.

### Fossil Dispatch

When the fossil fill fraction is greater than zero for any dispatch period, the system is considered to include fossil backup. The fossil fill fraction defines the solar output level at which the backup system runs during each hour of a specific dispatch period. For example, a fossil fill fraction of 1.0 would require that the fossil backup operate to fill in every hour during a specified period to 100% of design output. In that case, during periods when solar is providing 100% output, no fossil energy would be used. When solar is providing less than 100% output, the fossil backup operates to fill in the remaining energy so that the system achieves 100% output. For a fossil fill fraction of 0.5, the system would use energy from the fossil backup only when solar output drops below 50%.

The boiler LHV efficiency value on the [Power Block page](#) determines the quantity of fuel used by the fossil backup system. A value of 0.9 is reasonable for a natural gas-fired backup boiler. SAM includes the cost of fuel for the backup system in the [levelized cost of energy \(LCOE\)](#) and other metrics reported in the results, and reports the energy equivalent of the hourly fuel consumption in the [time series](#) simulation results. The cost of fuel for the backup system is defined on the [Trough System Costs page](#).

### Defining Dispatch Schedules

The storage dispatch schedules determine when each of the six periods apply during weekdays and weekends throughout the year.

If your analysis includes [PPA price multipliers](#) and you want to use the same schedule for the multipliers and for the power cycle dispatch control, click **Copy schedule from TOD Factors** page to apply the TOD Factors schedule matrices to the dispatch schedule matrices.

#### To specify a weekday or weekend schedule:

1. Assign values as appropriate to the Storage Dispatch, Turbine Output Fraction, and Fossil Fill Fraction for each of the up to nine periods.
2. Use your mouse to draw a rectangle in the matrix for the first block of time that applies to period 2.

	12am	1am	2am	3am	4am	5am	6am	7am	8am	9am	10am	11am	12pm	1pm	2pm	3pm	4pm	5pm	6pm	7pm	8pm	9pm	10pm	11pm
Jan	1	1	1	1	1	1	1	1	1	1	1	1	1	1	1	1	1	1	1	1	1	1	1	1
Feb	1	1	1	1	1	1	1	1	1	1	1	1	1	1	1	1	1	1	1	1	1	1	1	1
Mar	1	1	1	1	1	1	1	1	1	1	1	1	1	1	1	1	1	1	1	1	1	1	1	1
Apr	1	1	1	1	1	1	1	1	1	1	1	1	1	1	1	1	1	1	1	1	1	1	1	1
May	1	1	1	1	1	1	1	1	1	1	1	1	1	1	1	1	1	1	1	1	1	1	1	1
Jun	1	1	1	1	1	1	1	1	1	1	1	1	1	1	1	1	1	1	1	1	1	1	1	1
Jul	1	1	1	1	1	1	1	1	1	1	1	1	1	1	1	1	1	1	1	1	1	1	1	1
Aug	1	1	1	1	1	1	1	1	1	1	1	1	1	1	1	1	1	1	1	1	1	1	1	1
Sep	1	1	1	1	1	1	1	1	1	1	1	1	1	1	1	1	1	1	1	1	1	1	1	1
Oct	1	1	1	1	1	1	1	1	1	1	1	1	1	1	1	1	1	1	1	1	1	1	1	1
Nov	1	1	1	1	1	1	1	1	1	1	1	1	1	1	1	1	1	1	1	1	1	1	1	1
Dec	1	1	1	1	1	1	1	1	1	1	1	1	1	1	1	1	1	1	1	1	1	1	1	1

- Type the number 2.

	12am	1am	2am	3am	4am	5am	6am	7am	8am	9am	10am	11am	12pm	1pm	2pm	3pm	4pm	5pm	6pm	7pm	8pm	9pm	10pm	11pm
Jan	1	1	1	1	1	1	1	1	1	1	1	1	1	1	1	1	1	1	1	1	1	1	1	1
Feb	1	1	1	1	1	1	1	1	1	1	1	1	1	1	1	1	1	1	1	1	1	1	1	1
Mar	1	1	1	1	1	1	1	1	1	1	1	1	1	1	1	1	1	1	1	1	1	1	1	1
Apr	1	1	1	1	1	1	1	1	1	1	1	1	1	1	1	1	1	1	1	1	1	1	1	1
May	1	1	1	1	1	1	1	1	1	1	2	2	2	2	2	2	1	1	1	1	1	1	1	1
Jun	1	1	1	1	1	1	1	1	1	1	2	2	2	2	2	2	1	1	1	1	1	1	1	1
Jul	1	1	1	1	1	1	1	1	1	1	2	2	2	2	2	2	1	1	1	1	1	1	1	1
Aug	1	1	1	1	1	1	1	1	1	1	2	2	2	2	2	2	1	1	1	1	1	1	1	1
Sep	1	1	1	1	1	1	1	1	1	1	1	1	1	1	1	1	1	1	1	1	1	1	1	1
Oct	1	1	1	1	1	1	1	1	1	1	1	1	1	1	1	1	1	1	1	1	1	1	1	1
Nov	1	1	1	1	1	1	1	1	1	1	1	1	1	1	1	1	1	1	1	1	1	1	1	1
Dec	1	1	1	1	1	1	1	1	1	1	1	1	1	1	1	1	1	1	1	1	1	1	1	1

- SAM shades displays the period number in the squares that make up the rectangle, and shades the rectangle to match the color of the period.

**Thermal Storage Dispatch Control**

Current dispatch schedule:

Note:  
Schedule libraries do not affect the Storage Dispatch, Turbine Output and Fossil Fill fractions below.

	Storage Dispatch		Turb. out.	Fossil fill	Payment
	w/ solar*	w/o solar*	fraction*	fraction*	Allocation Factor
Period 1:	0	0	1.1	0	1
Period 2:	0	0	1	0.5	1
Period 3:	0	0	1	0	1
Period 4:	0	0	1	0	1
Period 5:	0	0	1	0	1
Period 6:	0	0	1	0	1
Period 7:	0	0	1	0	1
Period 8:	0	0	1	0	1
Period 9:	0	0	1	0	1

**Weekday Schedule**

	12am	1am	2am	3am	4am	5am	6am	7am	8am	9am	10am	11am	12pm	1pm	2pm	3pm	4pm	5pm	6pm	7pm	8pm	9pm	10pm	11pm
Jan	1	1	1	1	1	1	1	1	1	1	1	1	1	1	1	1	1	1	1	1	1	1	1	1
Feb	1	1	1	1	1	1	1	1	1	1	1	1	1	1	1	1	1	1	1	1	1	1	1	1
Mar	1	1	1	1	1	1	1	1	1	1	1	1	1	1	1	1	1	1	1	1	1	1	1	1
Apr	1	1	1	1	1	1	1	1	1	1	1	1	1	1	1	1	1	1	1	1	1	1	1	1
May	1	1	1	1	1	1	1	1	1	1	2	2	2	2	2	2	1	1	1	1	1	1	1	1
Jun	1	1	1	1	1	1	1	1	1	1	2	2	2	2	2	2	1	1	1	1	1	1	1	1
Jul	1	1	1	1	1	1	1	1	1	1	2	2	2	2	2	2	1	1	1	1	1	1	1	1
Aug	1	1	1	1	1	1	1	1	1	1	2	2	2	2	2	2	1	1	1	1	1	1	1	1
Sep	1	1	1	1	1	1	1	1	1	1	1	1	1	1	1	1	1	1	1	1	1	1	1	1
Oct	1	1	1	1	1	1	1	1	1	1	1	1	1	1	1	1	1	1	1	1	1	1	1	1
Nov	1	1	1	1	1	1	1	1	1	1	1	1	1	1	1	1	1	1	1	1	1	1	1	1
Dec	1	1	1	1	1	1	1	1	1	1	1	1	1	1	1	1	1	1	1	1	1	1	1	1

**Weekend Schedule**

	12am	1am	2am	3am	4am	5am	6am	7am	8am	9am	10am	11am	12pm	1pm	2pm	3pm	4pm	5pm	6pm	7pm	8pm	9pm	10pm	11pm
Jan	1	1	1	1	1	1	1	1	1	1	1	1	1	1	1	1	1	1	1	1	1	1	1	1
Feb	1	1	1	1	1	1	1	1	1	1	1	1	1	1	1	1	1	1	1	1	1	1	1	1
Mar	1	1	1	1	1	1	1	1	1	1	1	1	1	1	1	1	1	1	1	1	1	1	1	1
Apr	1	1	1	1	1	1	1	1	1	1	1	1	1	1	1	1	1	1	1	1	1	1	1	1

- Repeat Steps 2-4 for each of the remaining periods that apply to the schedule.

## 21.5 System Costs

### CSP System Cost Notes.

The default cost values that appear when you create a file or case are intended to illustrate SAM's use. The cost data are meant to be realistic, but not to represent actual costs for a specific project. For more information and a list of online resources for cost data, see the [SAM website](#).

The direct capital costs in \$/kWe are in kilowatts of gross power block capacity rather than nameplate capacity because the size and cost of the power block is determined by the gross capacity, not the net capacity. The total installed cost in \$/kWe (actually overnight installed cost because it does not include financing during construction costs, which are accounted for on the [Financial Parameters](#) page) is in kilowatts of nameplate capacity, because that is what is delivered to the grid and is consistent with how costs are reported for utility generation technologies. The indirect costs in \$/Wac are in Watts of nameplate power block capacity because those costs that use the entire plant as the basis, not just the power block.

The System Costs page only available for cases with a cash-flow-based financial mode. It is not available with the No Financial Model option or the LCOE Calculator financial model.

### Direct Capital Costs

A direct capital cost represents an expense for a specific piece of equipment or installation service that applies in year zero of the cash flow.

**Note:** Because SAM uses only the total installed cost value in cash flow calculations, how you distribute costs among the different direct capital cost categories does not affect the final results.

#### Site Improvements (\$/m<sup>2</sup>)

A cost per square meter of solar field area to account for expenses related to site preparation and other equipment not included in the solar field cost category.

#### Solar Field (\$/m<sup>2</sup>)

A cost per square meter of solar field area to account for expenses related to installation of the solar field, including labor and equipment.

#### Storage (\$/kWh)

Cost per thermal megawatt-hour of storage capacity to account for expenses related to installation of the thermal storage system, including equipment and labor.

#### Fossil Backup (\$/kWe)

Cost per electric megawatt of power block gross capacity to account for the installation of a fossil backup system, including equipment and labor.

#### Power Plant (\$/kWe)

Cost per electric megawatt of power block gross capacity to account for the installation of the power block, including equipment and labor.

**Balance of Plant (\$/kWe)**

Cost per electric megawatt of power block gross capacity to account for additional costs.

**Contingency (%)**

A percentage of the sum of the site improvements, solar field, HTF system, storage, fossil backup, and power plant costs to account for expected uncertainties in direct cost estimates.

**Total Direct Cost (\$)**

The sum of improvements, solar field, HTF system, storage, fossil backup, power plant costs, and contingency costs.

**Indirect Capital Costs**

An indirect cost is typically one that cannot be identified with a specific piece of equipment or installation service.

**Note:** Because SAM uses only the total installed cost value in cash flow calculations, how you distribute costs among the different indirect capital cost categories does not affect the final results.

**Total Land Area**

The total land area required for the project, from the Solar Field or Heliostat Field page.

**Nameplate**

The system's nameplate capacity from the Power Block or Power Cycle page.

**EPC and Owner Cost**

EPC (engineer-procure-construct) and owner costs are associated with the design and construction of the project. SAM calculates the total cost as the sum of the Non-fixed Cost and Fixed Cost.

Typical costs that may be appropriate to include in the EPC and Owner category are: Permitting, royalty payments, consulting, management or legal fees, geotechnical and environmental surveys, interconnection costs, spare parts inventories, commissioning costs, and the owner's engineering and project development activities.

**Total Land Costs**

Costs associated with land purchases, which SAM calculates as the sum of a non-fixed cost and a fixed cost. Use the Land category described below for land costs, and inputs on the [Financial Parameters](#) page for financing costs.

SAM calculates the total EPC and Owner Costs and Total Land Costs by adding the four costs that you can specify using different units.

**\$/acre**

A cost in dollars per total land area in acres.

**% of direct cost**

A cost as a percentage of **Total Direct Cost** under **Direct Capital Cost**.

**\$/Wac**

A cost in dollars per AC Watt of nameplate capacity.

**\$**

A fixed dollar amount

## Sales Tax

### Sales tax basis, %

The percentage of total direct cost used to calculate sales tax amount.

SAM calculates the total sales tax amount by multiplying the sales tax rate from the [Financial Parameters](#) page by the sales tax basis on the System Costs page:

$$\text{Total Sales Tax (\$)} = \text{Sales Tax Rate (\%)} \times \text{Sales Tax Basis (\%)} \times \text{Total Direct Cost (\$)}$$

For an explanation of the effect of sales tax on income tax, see **Sales Tax** on the [Financial Parameters](#) topic for the financial model you are using (Residential, Commercial, Single Owner, etc.)

### Total Indirect Cost (\$)

The sum of engineer-procure-construct costs, project-land-miscellaneous costs, and sales tax.

## Total Installed Cost

The total installed cost is the sum of all of the direct and indirect capital costs that you specify. SAM uses this value to calculate the project's [net capital cost](#), which is the total installed cost less any cash incentives on the [Incentives](#) page and plus any additional financing costs from [Financial Parameters](#) page.

### Total installed cost (\$)

The sum of total direct cost and total indirect cost.

### Total installed cost per capacity (\$/Wdc or \$/kW)

Total installed cost divided by the total system rated or nameplate capacity. This value is provided for reference only. SAM does not use it in cash flow calculations.

## Operation and Maintenance Costs

Operation and Maintenance (O&M) costs represent annual expenditures on equipment and services that occur after the system is installed. SAM allows you to enter O&M costs in three ways: Fixed annual, fixed by capacity, and variable by generation. O&M costs are reported on the project [cash flow](#).

For each O&M cost category, you can specify an optional annual **Escalation Rate** to represent an expected annual increase in O&M cost above the annual inflation rate specified on the [Financial Parameters](#). For an escalation rate of zero, the O&M cost in years two and later is the year one cost adjusted for inflation. For a non-zero escalation rate, the O&M cost in years two and later is the year one cost adjusted for inflation plus escalation.

For expenses such as component replacements that occur in particular years, you can use an annual schedule to assign costs to individual years. See below for details.

### Fixed Annual Cost (\$/yr)

A fixed annual cost that applied to each year in the project cash flow.

### Fixed Cost by Capacity (\$/kW-yr)

A fixed annual cost proportional to the system's rated or nameplate capacity.

### Variable Cost by Generation (\$/MWh)

A variable annual cost proportional to the system's total annual electrical output in AC megawatt-hours. The annual energy output depends on either the performance model's calculated first year value and the **degradation rate** from the [Lifetime](#) page, or on an annual schedule of costs, depending on the option

chosen.

### Fossil Fuel Cost (\$/MMBtu)

The cost per million British thermal units for fuel. SAM uses the conversion factor 1 MWh = 3.413 MMBtu. SAM calculates a fossil fuel cost for concentrating solar power systems with fossil backup, and for the generic system when the heat rate on the [Power Plant](#) page is not zero.

**Note.** If you are using the [generic system](#) model to represent a system that does not consume fuel, you should use a fuel cost of zero.

## 22 IPH Parabolic Trough

The industrial process heat parabolic trough model is similar to the [CSP physical trough](#) model, but assumes that heat from the solar field is used for a thermal application rather than to drive a power cycle for electricity generation. It is for a solar field of parabolic trough concentrating collectors.

### 22.1 Location and Resource

The Location and Resource page provides access to the solar resource library, which is a collection of weather files stored on your computer. When you first install SAM, it comes with a few default weather files in the library. As you use SAM for your own projects, you should add files to build your own library. Once files are in your library, you can use them for different projects and with different versions of SAM.

The screenshot shows the 'Solar Resource Library' window. At the top, it says 'The Solar Resource library is a list of weather files stored on your computer, or use the tools below to add files to the library.' Below this is a search bar and a table of weather files. A green callout box points to the table with the text 'Choose a weather file from the library.' The table has columns for Name, Latitude, Longitude, Time zone, Elevation, and Station ID. Below the table, it says 'SAM scans the following folders on your computer for valid weather files to add to the solar resource library. To use weather files stored on your computer, add folders containing the files.' Below this is a list of folders and two buttons: 'Add/remove weather file folders...' and 'Refresh library'. A second green callout box points to the list of folders with the text 'List of solar resource folders.'

Name	Latitude	Longitude	Time zone	Elevation	Station ID
daggett_ca_34.865371_-116.783023_psmv3_60_tmy	34.85	-116.78	-8	561	91486
des_moines_ia_41.586835_-93.624959_psmv3_60_tmy	41.57	-93.62	-6	263	757516
faroo_nd_46.9_-96.8_mts1_60_tmy	46.9	-96.8	-6	274	14914

C:\Users\<user>\SAM Downloaded Weather Files  
 F:\little\_rock\_ar  
 F:\PVGIS 5



**Weather Data Information**

The following information describes the weather file used for the Solar Resource library above. This is the file SAM will use when you click Simulate.

Weather file:  [View data](#)

**-Header Data from Weather File-**

City	<input type="text" value="-"/>	Station ID	<input type="text" value="91486"/>	Latitude	<input type="text" value="34.85 *N"/>
State	<input type="text" value="-"/>	Data Source	<input type="text" value="NSRDB"/>	Longitude	<input type="text" value="-116.78 *E"/>
Country	<input type="text" value="-"/>	Elevation	<input type="text" value="561 m"/>	Time zone	<input type="text" value="GMT -8"/>

**-Annual Averages Calculated from Weather File Data-**

Global horizontal	<input type="text" value="NaN"/>	kWh/m <sup>2</sup> /day	Average temperature	<input type="text" value="17.3"/>	°C
Direct normal (beam)	<input type="text" value="7.65"/>	kWh/m <sup>2</sup> /day	Average wind speed	<input type="text" value="2.4"/>	m/s
Diffuse horizontal	<input type="text" value="1.27"/>	kWh/m <sup>2</sup> /day	*NaN indicates missing data.		

**Weather file for simulation.**

**Information from weather file header.**

**Summary data calculated from time series data.**

There are two ways to add files to your solar resource library:

### 1. Download files from the NREL National Solar Radiation Database (NSRDB)

Use the download weather file options and click **Download and add to library** to get the most up-to-date data from the NSRDB for long-term cash flow analysis, single-year analysis, and P50/P90 analysis.

### 2. Add weather file folders

If you have weather files from a source other than the NSRDB or that you've downloaded yourself directly from the NSRDB website, click **Add/remove weather file folders** to add the folder containing the files to the **Solar Data File Folders** list. SAM automatically adds any weather files it finds in these folders to the solar resource library so they will appear in the list.

When you install SAM, it creates the default download folder `<user>/SAM Downloaded Weather Files` folder where weather files you download from the NSRDB are stored. You can change that folder by clicking **Add/remove weather file folders** and changing the **Folder for Downloaded Solar Data Files**.

For locations not in the NSRDB, you can download weather files in the EPW format from the European Commission Photovoltaic Geographical Information System [PVGIS V5 website](#).

### See also

- [Weather File Formats](#)
- [Weather Data Elements](#)
- [Typical and Single Year](#)
- [Time and Sun Position](#)
- [Folders and Libraries](#)
- [Weather Data and LK](#)

**Notes.**

You may want to model your system using weather data from several different sources and locations around your project site to understand how sensitive your analysis results are to the weather assumptions, and how much variation there is in the data from the different weather files.

You can compare results for a system using more than one weather file in a single case by using SAM's [parametric simulation](#) option.

For more information about weather data, including where to find data for locations outside of the United States, see [Weather Data](#) on the SAM website.

For a helpful discussion of weather data and power system simulation, see Sengupta, M.; Habte, A.; Gueymard, C.; Wilbert, S.; Renne, D.; Stoffel, T. (2017). "Best Practices Handbook for the Collection and Use of Solar Resource Data for Solar Energy Applications: Second Edition." NREL Report No. TP-5D00-68886. ([PDF 8.1 MB](#))

## ▼ Solar Resource Library

SAM's solar resource library displays information from weather files in your solar resource data folders. The default solar resource library that comes with SAM contains weather files for a few locations around the United States for the default configurations. As you use SAM, use **Add/remove weather file folders** to build a library of files for locations you frequently use as described in [Folders and Libraries](#).

### **To choose a file from the solar resource library:**

- Click the location name in the list. You can type a few letters of the file name in the Search box to filter the list.

The full file name and information about the selected file appears under **Weather Data Information**. To see the data in the file, click **View data**.

The screenshot shows the 'Solar Resource Library' window. At the top, it says 'The Solar Resource library is a list of weather files on your computer, or use the tools below to add files to the library.' Below this is a search box. The main area is a table with the following data:

Name	Latitude	Longitude	Time zone	Elevation	Station ID
daggett_ca_34.865371_-116.783023_psmv3_60_tmy	34.85	-116.78	-8	561	91486
des_moines_ia_41.586835_-93.624959_psmv3_60_tmy	41.57	-93.62	-6	263	757516
faroo_nd_46.9_-96.8_mts1_60_tmy	46.9	-96.8	-6	274	14914

Below the table, it says 'SAM scans the following folders on your computer for valid weather files to add to the solar resource library. To use weather files stored on your computer, add folders containing the files.' Below this is a list of folders:

- C:\Users\<user>\SAM Downloaded Weather Files
- F:\little\_rock\_ar
- F:\PVGIS 5

At the bottom right, there are two buttons: 'Add/remove weather file folders...' and 'Refresh library'.

### **Add/remove weather file folders**

Use the folder settings to tell SAM what folders on your computer it should scan for weather files to build the solar resource library. SAM adds any files it can identify as valid weather files in each folder you specify to the library.

Before adding a file to the library, SAM checks the data in the file displays a message if it finds any problems with the data in the file.

SAM will only add valid weather files to the library. If you add a folder that contains CSV files that are not in the SAM CSV format, it will not add those files to the library.

The list of solar resource folders are the folders that SAM scans for weather files to build the solar resource library.

### Refresh library

Refresh the library after adding files to the weather file folder. In most cases, SAM should automatically refresh the library as needed, but you may need to manually refresh it.

## Download Weather Files

SAM can download weather files from the latest National Solar Radiation Database (NSRDB) Physical Solar Model (PSM) datasets. For all NSRDB datasets, SAM can download single-year files or typical-year files.

**Note.** For locations not in the NSRDB, you can download EPW files from the European Commission Photovoltaic Geographical Information System [PVGIS V5 website](#) to a folder on your computer, and then use the [folder settings window](#) to add the folder to the list of folders SAM scans to build the solar resource library.

### To download a typical-year weather file for a single location:

1. Replace the text "Type a location name, street address or latitude and longitude" with a street address, city and state or country name, zip code, or latitude longitude pair. For example:
  - Golden, Colorado
  - golden, co
  - 15013 Denver West Parkway, Golden CO 80401
  - 80401
  - thimpu, bhutan
2. Click **Download and add to library**.

For more instructions to download multiple files, see [Weather File Download Instructions](#) below.

SAM converts the address you type to a latitude and longitude pair for the location, and submits that information to the NSRDB along with your email address. If the location is in the region covered by the NSRDB, it returns a weather file in the SAM CSV format, and adds it to your weather file download folder. Otherwise, it displays a message telling you the location is not covered by the NSRDB.

When you first install SAM, it creates the *SAM Downloaded Weather Files* folder and assigns it as your weather file download folder. You can change the weather file download folder by clicking **Add/Remove**

**weather file folders.** See [Folders and Libraries](#) for details.

When the download finishes, SAM displays a prompt asking you if you want to open the weather file download log. This prompt is the indication that the download finished. During the download and before that prompt appears, SAM may become unresponsive. If it does, wait for the prompt to avoid interrupting the download.

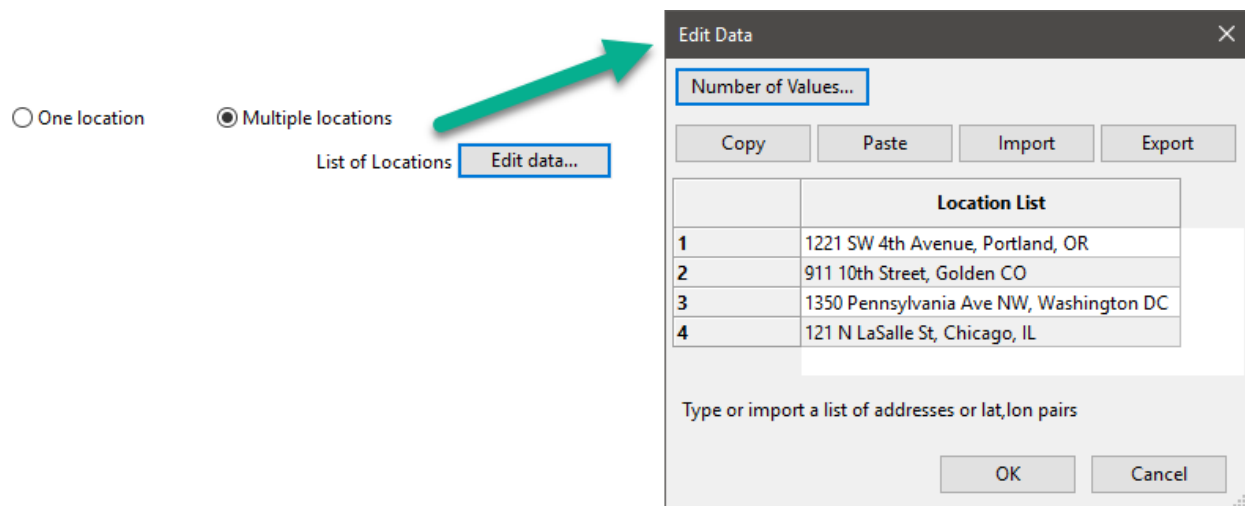
The weather file download log is a text file that SAM creates in your weather file download folder, and serves as a record of all of the files you download from the NSRDB. For each download, it lists the date and time of the request, the information you provided, the URL SAM generated, the name of the file returned by the NSRDB, or error messages it returns if the download fails. This information is useful for troubleshooting weather file download problems.

**Note.** Downloading multiple weather files from the NSRDB can take a long time. If you download files for multiple locations or years, be prepared to wait for the files to download. The download log file reports the time it takes for each file to download. Download times depend on your internet connection and computer. For a new computer with a fast connection, downloading and processing a single file takes about 10 seconds.

### One location, Multiple locations

Choose **One location** to download a weather file for a single location.

Choose **Multiple locations** to submit a list of locations and download a file or files for each location. For Multiple locations, click **Edit data** to open the Edit Data window where you can enter the list of locations and click **Number of Values** to enter the number of locations in the list.

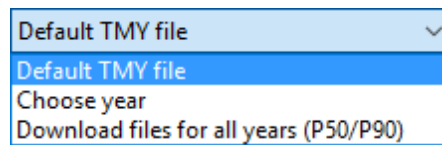


### 60-minute, 30-minute

Choose **60-minute** to download weather files with hourly time steps or 8,760 data records.

Choose **30-minute** to download files with 30-minute time steps or 17,520 data records. Thirty-minute data is not available for the NSRDB SUNY International dataset.

## Download options



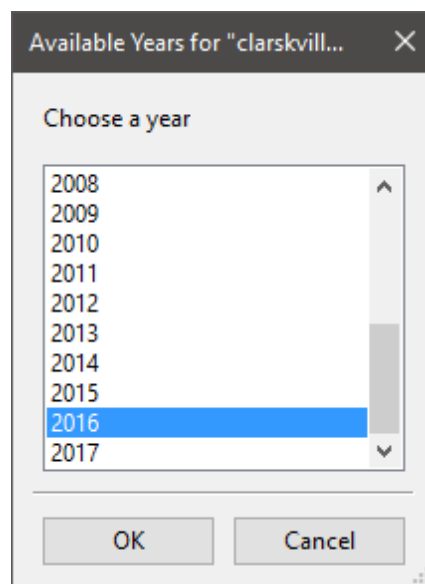
### Default TMY file

Download a typical meteorological year weather file for the location or locations you specified.

Typical year data is appropriate when you are using simulation results for a single year to make cash flow calculations over a multi-year period.

### Choose year

Choose a single year file to download. After you click the Download button, SAM prompts you with a list of available years for each location you requested to choose a year.



The single year option is appropriate when you want to see how the system would perform in a particular year. For example, for a residential or commercial system, if you have measured building load data for a given year, you could use weather data for the same year to see how the system's power output compares to the load.

If you use both **Choose year** and **Multiple locations**, SAM prompts you for a year for each location.

SAM queries the NSRDB to generate the list of available years. The list of available years varies between regions.

### Download files for all years (P50/P90)

Download a set of single-year files covering the range of historical data (nineteen files for 1998 through 2017 as of October 2018 for PSM data). When you click download, SAM creates a folder in your weather file download folder to store the single year files based on the location address or latitude-longitude pair you typed. It also downloads the typical meteorological year (TMY) file for the location and stores it in your weather file download folder.

SAM appends an underscore with the year to the file name so that the P50 P90 simulations work

correctly. See [P50/P90 Simulations](#) for details.

If you choose to download files for all years with **Multiple locations**, SAM downloads a set of files for each location, and puts the files for each location in a separate folder. Note that this may take a long time.

## Weather File Download Instructions

### Examples of valid street address or latitude-longitude pairs:

- golden colorado
- golden, co
- 15013 Denver West Parkway, Golden CO 80401
- 80401
- 39.75, -105.15
- Super Market, F-6 Markaz, Islamabad, Pakistan
- New Delhi, India

**Note.** When the download finishes, SAM displays a prompt asking you if you want to open the weather file download log. This prompt is the indication that the download finished. During the download and before that prompt appears, SAM may become unresponsive. If it does, wait for the prompt to avoid interrupting the download.

### To download an hourly typical-year (TMY) weather file from the NSRDB (use this option for most situations):

1. Click **One location**.
2. Type either a street address or latitude-longitude pair.
3. Click **60-minute**.
4. Choose **Default TMY File**.
5. Click **Download and add to library**.

### To download files for more than one location:

1. Click **Multiple locations**.
2. Click **Edit data**.
3. In the Edit Data window, click **Number of Values** and type the number of locations to create a table with a row for each location.
4. Type a street address or latitude-longitude pair in the table for each location.
5. Click **OK**.
6. Choose a time step, **60-minute** for hourly, or **30-minute** for 30-minute data.
7. Choose the type of file(s) you want to download as described below.
8. Click **Download and add to library**.

## Weather Data Information

**Weather Data Information**  
The following information describes the weather file in the Solar Resource library above. This is the file SAM will use when you click Simulate.

Weather file:  [View data](#)

**-Header Data from Weather File-**

City	<input type="text" value="-"/>	Station ID	<input type="text" value="91486"/>	Latitude	<input type="text" value="34.85 *N"/>
State	<input type="text" value="-"/>	Data Source	<input type="text" value="NSRDB"/>	Longitude	<input type="text" value="-116.78 *E"/>
Country	<input type="text" value="-"/>	Elevation	<input type="text" value="561 m"/>	Time zone	<input type="text" value="GMT -8"/>

**-Annual Averages Calculated from Weather File Data-**

Global horizontal	<input type="text" value="NaN"/>	kWh/m <sup>2</sup> /day	Average temperature	<input type="text" value="17.3"/>	°C
Direct normal (beam)	<input type="text" value="7.65"/>	kWh/m <sup>2</sup> /day	Average wind speed	<input type="text" value="2.4"/>	m/s
Diffuse horizontal	<input type="text" value="1.27"/>	kWh/m <sup>2</sup> /day	*NaN indicates missing data.		

### Weather File

The path and name of the active weather file SAM will use for simulation. Download a different file from the NSRDB, or click a different file name in the library to change the file.

### View data

Display weather file data in the [time series data viewer](#).

**Note.** You can also see the data after running a simulation on the Results page [data tables](#) and [time series graphs](#).

### Header Data from Weather File

Header data is information in the weather file that describes the location and type of data in the file. SAM uses the time zone, elevation, latitude and longitude to calculate the sun position during simulations. It does not use the city, state, country, and other descriptive information.

### Annual Values Calculated from Weather File

When you add a weather file to the solar resource library, SAM reads weather data from the file and calculates the annual values to display for your reference. It does not use annual values during simulations.

#### Global horizontal, Direct normal (beam), Diffuse horizontal

The sum of solar irradiance data (W/m<sup>2</sup>) in the weather file converted to kW and divided by 365 days/year.

#### Average temperature

The sum of temperature data (°C) in the weather file divided by the number of records in the file (8760 for hourly data).

#### Average wind speed

The sum of wind speed data (m/s) in the weather file divided by the number of records in the file (8760 for hourly data).

### Maximum snow depth

If the weather file contains snow depth data, the maximum value of snow depth data (cm) in the weather file. NaN indicates the file does not contain snow depth data. Snow depth data is required for to model snow losses for the Detailed Photovoltaic and PVWatts models.

**Note.** For information about where to find weather files with snow depth data, see the note on the [Weather Data](#) page of the SAM website.

### Annual albedo

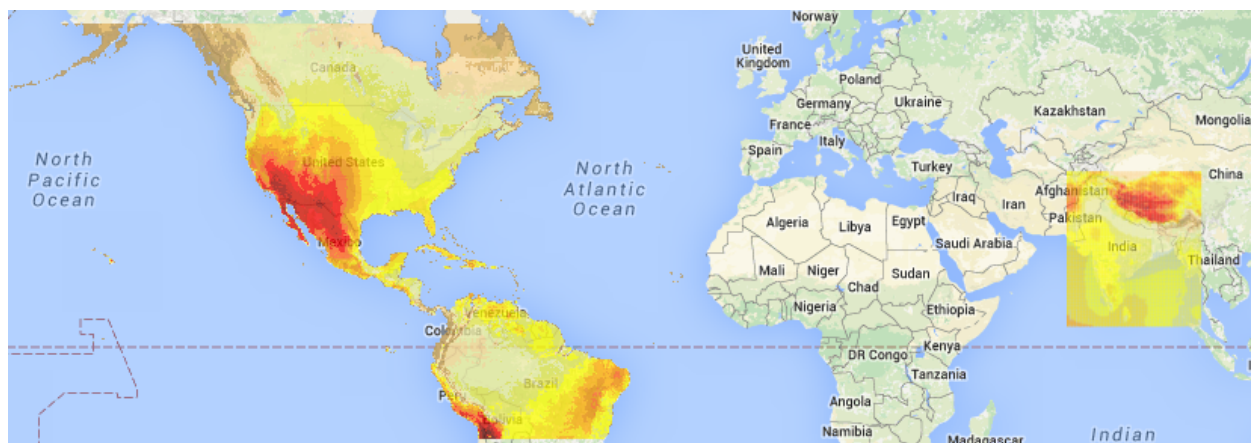
If the weather file contains albedo (ground reflectance) data, the average value of albedo values in the weather file. NaN indicates the file does not contain albedo data.

## ▼ About the NSRDB

The [NREL National Solar Radiation Database \(NSRDB\)](#) is an online database of weather files containing solar resource data in the [SAM CSV format](#). Files are available both as [typical-year](#) files and [single-year](#) files. The database covers the parts of the Americas and Asia shown in the map below. The current data is called PSM (Physical Solar Model) for the U.S., and SUNY for Asia. For details about the data see these pages on the NSRDB website:

- [U.S. data](#)
- [International data](#)

The NSRDB also contains legacy datasets for the U.S. from older versions of the NSRDB, including MTS3 (TMY3 1991-2010), MTS2 (TMY3 1991-2005), and MTS1 (TMY2 1961-1990). We recommend that you use the latest PSM data for your work in SAM, but the older data is available if you need it.



**Important Note for CSP Modelers!** SAM's CSP models assume that each DNI value in the weather file represents the average irradiance over the time step, and calculate sun angles for the midpoint of the time step. In weather files from the NSRDB, the irradiance data is measured instantaneously at either the beginning of the hour (TMY data), midpoint of the hour (single-year data), or beginning of the 30-minute time step (30-minute single-year data). As a result, if you use an NSRDB PSM weather file with a CSP model with either hourly TMY data or 30-minute single-year data, the sun angle for each time step will be for a different time than the time for the instantaneous irradiance values. See [Time Convention and Sun Position](#) for details.



**Notes.**

The NSRDB requires an email address to download weather file. When you download a weather file from SAM, SAM submits the email address that you used to [register SAM](#). NREL uses your email address to determine how many people are using the NSRDB. It does not share email addresses.

Different types of weather files in the NSRDB use different time conventions. See [Time Convention and Sun Position](#) for details.

When you download a file from the NSRDB website, SAM displays a "-" for the City, State, and Country fields because the NSRDB files do not contain that information. This will not affect simulation results. The location information SAM requires for simulations is latitude, longitude, elevation and time zone.

SAM uses the [Google Maps API Geocoding Service](#) service to identify the geographic coordinates (latitude and longitude) of a location when you type a street address or city and state name to identify the location.

For information about downloading weather files and data from other sources, see the [Weather Data](#) page on the SAM website.

SAM downloads weather files with the following hourly data from the NSRDB:

- Direct normal (beam) irradiance, DNI (W/m<sup>2</sup>)
- Diffuse horizontal irradiance, DHI (W/m<sup>2</sup>)
- Dry-bulb temperature (°C)
- Dew-point temperature (°C)
- Relative humidity (%), for single-year files only
- Atmospheric pressure (mbar)
- Wind speed at 2 meters above the ground (m/s)
- Wind direction (°E of N)
- Albedo

**Note.** Weather files with snow depth data for the Detailed Photovoltaic model are not available from the NSRDB PSM dataset. They are available for 239 locations in the United States from the legacy [MTS1 \(TMY2\) files in the original format](#), which cover the period 1961 - 1990. See [Snow Losses](#) for details.

## 22.2 System Design

The System Design page shows inputs for design point parameters that determine the system's nameplate capacity. Use the System Design inputs to define the nominal ratings of the system, and then specify details for each part of the system on the appropriate input pages.

**Notes.** All of the system design inputs are nominal values, or values at the system's design point. SAM calculates actual values during simulation and reports them in the [results](#).

## Design Point Parameters

### Solar Field

#### Design-point DNI, W/m<sup>2</sup>

The direct normal irradiance (DNI) available at the design point.

Increasing this value indicates that fewer heliostats are needed to achieve the reference condition power, while decreasing this value has the opposite effect. The design-point DNI value should represent the DNI at which your plant should achieve the specified thermal rating, including thermal and piping losses

For design-point calculations involving solar irradiance, SAM uses the design-point DNI value with the sun position at noon on the summer solstice (June 21 north of the equator, and December 21 south of the equator).

#### Target solar multiple

The design ratio of the target receiver thermal power and heat sink power. This value can be used to oversize the receiver design output relative to the heat sink.

#### Target receiver thermal power, MWt

The thermal power required at the receiver outlet to meet the design thermal load.

$$\text{Receiver Thermal Power (MWt)} = \text{Solar Multiple} \times \text{Heat Sink Power (MWt)}$$

#### Loop inlet HTF temperature (°C)

The temperature of HTF at the loop inlet under design conditions. The actual temperature during operation may differ from this value.

#### Loop outlet HTF temperature (°C)

The temperature of the HTF at the outlet of the loop under design conditions. During operation, the actual value may differ from this set point. This value represents the target temperature for control of the HTF flow through the solar field and will be maintained when possible.

### Heat Sink

The heat sink parameters describe the process heat application's thermal load.

#### Heat sink power (MWt)

Thermal input to the heat sink at design. Together with the target solar multiple, this value determines the receiver design conditions. For future versions of this model that may contain thermal energy storage, this parameter will guide the interaction between the heat sink and thermal energy storage.

#### Pumping power for HTF through heat sink (kW/kg/s)

The electricity consumption per unit of mass flow rate associated with pumping the HTF through the heat sink.

#### Choose Number of Loops

This macro allows the user to specify the number of loops in the simulation. The macro then calculates the corresponding heat sink power and gives the user the option to set it as the new input.

## Thermal Storage

### Hours of storage at design point, hours

The nominal thermal storage capacity expressed in hours at full load: The number of hours that the storage system can supply energy at the design point.

## System Availability

System availability losses are reductions in the system's output due to operational requirements such as maintenance down time or other situations that prevent the system from operating as designed.

**Note.** To model curtailment, or forced outages or reduction in power output required by the grid operator, use the inputs on the [Grid Limits](#) page.

To edit the system availability losses, click **Edit losses**.

The [Edit Losses](#) window allows you to define loss factors as follows:

- Constant loss is a single loss factor that applies to the system's entire output. You can use this to model an availability factor.
- Hourly losses apply to specific hours of the year.

SAM reduces the system's output in each hour by the loss percentage that you specify for that hour. For a given hour, a loss of zero would result in no adjustment. A loss of 5% would reduce the output by 5%, and a loss of -5% would increase the output value by 5%. For subhourly simulations, SAM applies the loss factor for a given hour to each time step in that hour

## System Summary

### Actual number of loops

The actual number of loops in the field, equal to the solar multiple times the required number of loops at a solar multiple of 1.0. The required number of loops is rounded to the nearest integer to represent a realistic field layout.

### Total aperture reflective area (m<sup>2</sup>)

The actual aperture area based on the actual number of loops in the field, equal to the single loop aperture times the actual number of loops.

### Actual solar multiple

For Option 1 (solar multiple mode), the calculated solar multiple based on the actual (rounded) number of loops in the field. For Option 2 (field aperture mode), the solar multiple value corresponding to the thermal output of the field based at design point: The total aperture reflective area divided by the field thermal output.

### Actual field thermal output (MWt)

The thermal energy delivered by the solar field under design conditions at the actual solar multiple.

## 22.3 Solar Field

### System Design Point Parameters

These values are from the [System Design page](#) are for reference.

### Solar Field Design Point

The design point variables show values at the Irradiation at Design Value that SAM uses to determine the system capacity in sizing calculations.

#### Single loop aperture (m<sup>2</sup>)

The aperture area of a single loop of collectors, equal to the product of aperture width, reflective area, times the structure length times the number of collector assemblies per loop according to the distribution of the up to four collector types in the field. This area does not include non-reflective surface on the collector or non-reflective space between collectors.

*Single Loop Aperture (m<sup>2</sup>) = Sum of the SCA Reflective Aperture Area (m<sup>2</sup>) values for each SCA in the loop*

The SCA reflective aperture area for each SCA type is specified on the [Collectors \(SCAs\)](#) page. The number of each type of SCA in a single loop is specified under **Single Loop Configuration** as described in [Specifying the Loop Configuration](#).

#### Loop optical efficiency

The optical efficiency when incident radiation is normal to the aperture plane, not including end losses or cosine losses. This value does not include thermal losses from piping and the receivers.

*Loop Optical Efficiency = SCA Optical Efficiency at Design × HCE Optical Derate*

The SCA and HCE optical efficiency values are from the [Collectors \(SCA\)](#) page and [Receivers \(HCEs\)](#) page, respectively.

#### Total loop conversion efficiency

The total conversion efficiency of the loop, including optical losses and estimated thermal losses. Used to calculate the required aperture area of the solar field.

#### Total required aperture, SM=1 (m<sup>2</sup>)

The exact mirror aperture area required to meet the design thermal output for a solar multiple of 1.0. SAM uses the required aperture to calculate the total aperture reflective area. The total aperture reflective area may be slightly more or less than the required aperture, depending on the collector dimensions you specify on the [Collectors page](#).

#### Required number of loops, SM=1

The exact number of loops required to produce the total required aperture at a solar multiple of 1.0. This number may be a non-integer value, SAM rounds this value to the nearest integer to calculate the value of the actual number of loops variable.

#### Actual number of loops

The actual number of loops in the field, equal to the solar multiple times the required number of loops at a solar multiple of 1.0. The required number of loops is rounded to the nearest integer to represent a realistic field layout.

**Total aperture reflective area (m<sup>2</sup>)**

The actual aperture area based on the actual number of loops in the field, equal to the single loop aperture times the actual number of loops.

**Actual solar multiple**

For Option 1 (solar multiple mode), the calculated solar multiple based on the actual (rounded) number of loops in the field. For Option 2 (field aperture mode), the solar multiple value corresponding to the thermal output of the field based at design point: The total aperture reflective area divided by the field thermal output.

**Actual field thermal output (MWt)**

The thermal energy delivered by the solar field under design conditions at the actual solar multiple.

**Solar Field Parameters****Row spacing (m)**

The centerline-to-centerline distance in meters between rows of collectors, assuming that rows are laid out uniformly throughout the solar field. Default is 15 meters.

**Stow angle (degrees)**

The collector angle during the hour of stow. A stow angle of zero for a northern latitude is vertical facing east, and 180 degrees is vertical facing west. Default is 170 degrees.

**Deploy angle (degrees)**

The collector angle during the hour of deployment. A deploy angle of zero for a northern latitude is vertical facing due east. Default is 10 degrees.

**Header pipe roughness (m)**

The header pipe roughness is a measure of the internal surface roughness of the header and runner piping. SAM uses this value in calculation of the shear force and piping pressure drop in the headers.

Surface roughness is important in determining the scale of the pressure drop throughout the system. As a general rule, the rougher the surface, the higher the pressure drop (and parasitic pumping power load). The surface roughness is a function of the material and manufacturing method used for the piping.

**HTF pump efficiency**

The electrical-to-mechanical energy conversion efficiency of the field heat transfer fluid pump. This value accounts for all mechanical, thermodynamic, and electrical efficiency losses.

**Piping thermal loss coefficient (W/m<sup>2</sup>-K)**

The thermal loss coefficient that is used to calculate thermal losses from piping between receivers, crossover piping, header piping, and runner piping. The coefficient specifies the number of thermal watts lost from the system as a function of the piping surface area, and the temperature difference between the fluid in the piping and the ambient air (dry bulb temperature). The length of crossover piping depends on the row spacing variable above, and the piping distance between assemblies on the [Collectors](#) page.

**Wind stow speed, m/s**

When the wind speed in the weather file exceeds this value, the collectors in field defocus and the field thermal power incident on the field goes to zero to model the effect of collectors moving to a safe position to avoid wind damage. When the wind speed falls below the wind stow speed, the field power returns to normal.

### Tracking power (W/sca)

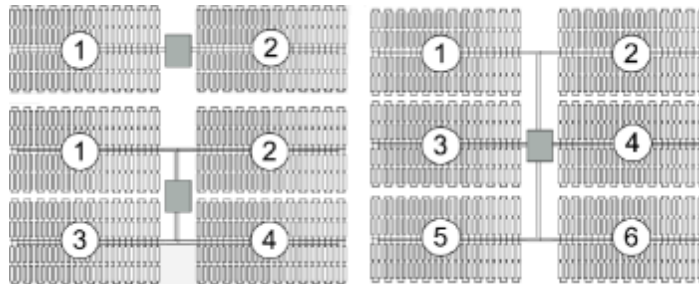
The amount of electrical power consumed by a single collector tracking mechanism. SAM only calculates tracking losses during hours when collectors are actively tracking the sun. The total field tracking power is calculated by multiplying this value by the number of loops in the field and number of assemblies per loop.

### Total tracking power

Calculated as the product of the tracking power and number of collectors from the [Collectors page](#).

### Number of field subsections

SAM assumes that the solar field is divided into between two and 12 subsections. Examples of solar field with 2, 4, and 6 subsections are shown below:



The number of field subsections determine the location and shape of header piping that delivers heat transfer fluid to the power block, which affects the heat loss calculation.

### Model piping through heat sink?

Choose this option to model heat losses for piping through a heat sink.

### Length of piping through heat sink

Length of field piping that passes through a heat sink.

## Heat Transfer Fluid

### Field HTF fluid

The heat transfer fluid (HTF) used in the heat collection elements and headers of the solar field. SAM includes the following options in the HTF library: Solar salt, Caloria, Hitec XL, Therminol VP-1, Hitec salt, Dowtherm Q, Dowtherm RP, Therminol 59, and Therminol 66. You can also define your own HTF using the user-defined HTF fluid option.

**Note.** During the simulation, SAM counts the number of instances that the HTF temperature falls outside of the operating temperature limits in the table below. If the number of instances exceeds 50, it displays a simulation [notice](#) with the HTF temperature and time step number for the 50th instance.

If you define a custom fluid, SAM disables the minimum and maximum operating temperature variables and displays zero because it does not have information about the operating limits for the fluid you defined. You can check the time series temperature data in the results to ensure that they do not exceed the limits for your custom fluid.

**Heat transfer fluids on the Field HTF Fluid list.**

Name	Type	Min Optimal Operating Temp °C	Max Optimal Operating Temp* °C	Freeze Point °C	Comments
Hitec Solar Salt	Nitrate Salt	238	593	238	
Hitec	Nitrate Salt	142	538	142	
Hitec XL	Nitrate Salt	120	500	120	
Caloria HT 43	Mineral Hydrocarbon	-12	315	-12 (pour point)	used in first Luz trough plant, SEGS I
Therminol VP-1	Mixture of Biphenyl and Diphenyl Oxide	12	400	12 (crystallization point)	Standard for current generation oil HTF systems
Therminol 59	Synthetic HTF	-45	315	-68 (pour point)	
Therminol 66	?	0	345	-25 (pour point)	
Dowtherm Q	Synthetic Oil	-35	330	n/a	
Dowtherm RP	Synthetic Oil	n/a	330	n/a	

\*The maximum optimal operating temperature is the value reported as "maximum bulk temperature" on the product data sheets.

**Data Sources for HTF Properties**

Hitec fluids: Raade J, Padowitz D, Vaughn J. [Low Melting Point Molten Salt Heat Transfer Fluid with Reduced Cost](#). Halotechnics. Presented at SolarPaces 2011 in Granada, Spain.

Caloria HT 43: [Product comparison tool](#) on Duratherm website.

Therminol Fluids: Solutia [Technical Bulletins](#) 7239115C, 7239271A, 7239146D.

Dowtherm Fluids: Dow [Data Sheet](#) for Q, no data sheet available for RP (high temp is from website): <http://www.dow.com/heattrans/products/synthetic/dowtherm.htm>.

**User-defined HTF fluid**

To define your own HTF, choose User-defined for the Field HTF fluid and specify a table of material properties for use in the solar field. You must specify at least two data points for each property: temperature, specific heat, density, viscosity, and conductivity. See [Custom HTF](#) for details.

**Field HTF min operating temp (°C)**

The minimum HTF operating temperature recommended by the HTF manufacturer.

In some cases the minimum operating temperature may be the same as the fluid's freeze point. However, at the freeze point the fluid is typically significantly more viscous than at design operation temperatures, so it is likely that the "optimal" minimum operating temperature is higher than the freeze point.

**Field HTF max operating temp (°C)**

The minimum HTF operating temperature recommended by the HTF manufacturer.

Operation at temperatures above this value may result in degradation of the HTF and be unsafe. To avoid this, you may want to include a safety margin and use a maximum operating temperature value slightly lower than the recommended value.

**Notes.**

SAM displays the operating temperature limits for your reference so you can compare them to the field temperatures reported in the results to ensure that they do not exceed the limits. SAM does not adjust the system's performance to avoid exceeding these operating limits.

SAM only displays these limits for fluids that are in SAM's library. If you use a custom HTF instead of one from the SAM library, SAM disables the HTF operating temperature limits. In this case, you should use data from the fluid manufacturer specifications.

**Freeze protection temp (°C)**

The minimum temperature that the heat transfer fluid is allowed to reach in the field. The temperature at which freeze protection equipment is activated.

SAM assumes that electric heat trace equipment maintains the fluid at the freeze protection temperature during hours that freeze protection is operating. **Design loop inlet temp (°C)**

The temperature of HTF at the loop inlet under design conditions. The actual temperature during operation may differ from this value.

**Min single loop flow rate (kg/s)**

The minimum allowable flow rate through a single loop in the field.

During time steps that produce a solar field flow rate that falls below the minimum value, the HTF temperature leaving the solar field will be reduced in temperature according to the heat added and minimum mass flow rate.

**Max single loop flow rate (kg/s)**

The maximum allowable flow rate through a single loop in the field.

During time steps that produce a solar field flow rate that exceeds the maximum value, the solar field will be defocused according to the strategy selected by the user on the Solar Field page until the absorbed energy and corresponding mass flow rate fall below the maximum value.

**Min field flow velocity (m/s)**

The minimum allowable HTF flow velocity through the field.

**Max field flow velocity (m/s)**

The maximum allowable HTF flow velocity through the field.

The minimum and maximum solar field HTF flow velocity depend on the minimum and maximum HTF mass flow rates, HTF density at the design loop inlet temperature, and the absorber tube inner diameter specified on the Receivers page. SAM calculates the field HTF flow velocity for the receiver type with the smallest diameter.

**Header design min flow velocity (m/s)**

The minimum allowable HTF flow velocity in the header piping under design conditions.



**Header design max flow velocity (m/s)**

The maximum allowable HTF flow velocity in the header piping under design conditions. The minimum/maximum header flow velocities are used to determine the diameter of the header piping as flow is diverted to each loop in the field. After flow is distributed (or collected) to/from the loops, System Advisor calculates the flow velocity and resizes the piping to correspond to the maximum velocity if the calculated value falls outside of the user-specified range.

**Collector Orientation****Collector tilt (degrees)**

The angle of all collectors in the field in degrees from horizontal, where zero degrees is horizontal. A positive value tilts up the end of the array closest to the equator (the array's south end in the northern hemisphere), a negative value tilts down the southern end. SAM assumes that the collectors are fixed at the tilt angle.

**Collector azimuth (degrees)**

The azimuth angle of all collectors in the field, where zero degrees is pointing toward the equator, equivalent to a north-south axis. West is 90 degrees, and east is -90 degrees. SAM assumes that the collectors are oriented 90 degrees east of the azimuth angle in the morning and track the daily movement of the sun from east to west.

**Mirror Washing**

SAM reports the water usage of the system in the results based on the mirror washing variables. The annual water usage is the product of the water usage per wash and 365 (days per year) divided by the washing frequency.

**Water usage per wash (L/m<sup>2</sup>,aper)**

The volume of water in liters per square meter of solar field aperture area required for periodic mirror washing.

**Washes per year**

The number of washes in a single year.

**Plant Heat Capacity**

The plant heat capacity values determine the thermal inertia due to the mass of hot and cold headers, and of SCA piping, joints, insulation, and other components whose temperatures rise and fall with the HTF temperature. SAM uses the thermal inertia values in the solar field energy balance calculations.

You can use the hot and cold piping thermal inertia inputs as empirical adjustment factors to help match SAM results with observed plant performance.

**Hot piping thermal inertia (kWht/K-MWt)**

The thermal inertia of the hot header to account for any thermal inertia not accounted for in the HTF volume calculations: Thermal energy in kilowatt-hours per gross electricity capacity in megawatts needed to raise the hot side temperature one degree Celsius. The default value is 0.2 kWht/K-MWt.

**Cold piping thermal inertia (kWh/K-MWt)**

The thermal inertia of the cold header to account for any thermal inertia not accounted for in the HTF volume calculations: Thermal energy in kilowatt-hours per gross electricity capacity in megawatts needed to raise the hot side temperature one degree Celsius. The default value is 0.2 kWh/K-MWt.

**Field loop piping thermal inertia (Wh/K-m)**

The thermal inertia of piping, joints, insulation, and other SCA components: The amount of thermal energy per meter of SCA length required to raise the temperature of piping, joints, insulation, and other SCA components one degree K. The default value is 4.5 Wh/K-m.

**Land Area**

The land area inputs determine the total land area in acres that you can use to estimate land-related costs in \$/acres on the [System Costs](#) page. The land area inputs are inputs to the financial model, not the performance model, so they do not affect the performance model energy calculations.

**Solar field area, acres**

The actual aperture area converted from square meters to acres:

$$\text{Solar Field Area (acres)} = \text{Actual Aperture (m}^2\text{)} \times \text{Row Spacing (m)} / \text{Maximum SCA Width (m)} \times 0.0002471 \text{ (acres/m}^2\text{)}$$

The maximum SCA width is the aperture width of SCA with the widest aperture in the field, as specified in the loop configuration and on the [Collectors \(SCA\)](#) page.

**Non-solar field land area multiplier**

Land area required for the system excluding the solar field land area, expressed as a fraction of the solar field aperture area. A value of one would result in a total land area equal to the total aperture area.

**Total land area, acres**

Land area required for the entire system including the solar field land area

$$\text{Total Land Area (acres)} = \text{Solar Field Area (acres)} \times (1 + \text{Non-Solar Field Land Area Multiplier})$$

The land area appears on the System Costs page, where you can specify land costs in dollars per acre.

**Single Loop Configuration**

The loop configuration and collector defocusing for the process heat trough model is the same as for the CSP physical trough model. For details about loop configuration. For details, see:

- [Specifying the Loop Configuration](#)
- [Defining Collector Defocusing](#)

**Number of SCA/HCE assemblies per loop**

The number of individual solar collector assemblies (SCAs) in a single loop of the field. Computationally, this corresponds to the number of simulation nodes in the loop. See [Specifying the Loop Configuration](#) for details.

**Edit SCAs**

Click **Edit SCAs** to assign an SCA type number (1-4) to each of the collectors in the loop. Use your mouse to select collectors, and type a number on your keyboard to assign a type number to the selected collectors. SAM indicates the SCA type by coloring the rectangle representing the collector in the diagram, and displaying the type number after the word "SCA."

### Edit HCEs

Click **Edit HCEs** to assign a receiver type number (1-4) to each of the collectors in the loop. Use your mouse to select collectors, and type a number on your keyboard to assign a type number. SAM indicates the HCE type by coloring the line representing the receiver, and displaying the type number after the word "HCE."

### Edit Defocus Order

Click **Edit Defocus Order** to manually define the defocus order of the collectors in the field. Click an assembly to assign the defocus order. You should assign each collector a unique defocus order number.

### Reset Defocus

Click to reset the defocus order to the default values, starting at the hot end of the loop and proceeding sequentially toward the cold end of the loop.

The collector defocusing inputs are the same as for the CSP physical trough model.

## 22.4 Collectors (SCAs)

A collector (SCA, solar collector assembly) is an individually tracking component of the solar field that includes mirrors, a supporting structure, and receivers.

**Note.** See the Troughnet website at [http://www.nrel.gov/csp/troughnet/solar\\_field.html](http://www.nrel.gov/csp/troughnet/solar_field.html) for more information about collectors.

On the Collectors page, you can define the characteristics of up to four collector types. On the Solar Field page [single loop configuration](#), you specify how the different collector types are distributed in each loop of the field, assuming that the field consists of identical loops. SAM only uses data for collector types that you have included in the single loop configuration on the Solar Field page

**Note.** For a detailed explanation of the physical trough model, see Wagner, M. J.; Gilman, P. (2011). *Technical Manual for the SAM Physical Trough Model*. 124 pp.; NREL Report No. TP-5500-51825. <http://www.nrel.gov/docs/fy11osti/51825.pdf> (3.7 MB)

### Collector Library

The physical trough model's collector [library](#) contains a set of collector parameters for several commercially available collectors. You can either use parameters from the library, or type your own parameter values.

#### To apply values from the library:

1. In the list of collectors at the top of the page, click a collector name. You can click a column heading to sort the list.
2. For the collector type to which you want to apply the parameters from the library, click **Apply Values from Library**. SAM will replace the collector geometry, and optical parameter values with values from the library.

You can modify the values after you apply the library values.

## Collector Type and Configuration Name

### Collector Type

Choose the active SCA type (1-4). SAM displays the properties of the active SCA type on the Collectors page. You can assign different properties to each of the up to four collector types. See [Specifying the Loop Configuration](#) for details on including different SCA types in the solar field.

### Configuration Name

The name of library entry for the receiver type.

## Collector Geometry

### Reflective aperture area (m<sup>2</sup>)

The total reflective area of a single collector, used to calculate the loop aperture area of a loop, and number of loops required for a solar field with the aperture area defined on the [Solar Field page](#).

### Aperture width, total structure (m)

The structural width of the collector, including reflective and non-reflective area. SAM uses this value to calculate row-to-row shadowing and blocking effects.

### Length of collector assembly (m)

The length of a single collector assembly.

### Number of modules per assembly

The number of individual collector-receiver sections in a single collector.

### Average surface-to-focus path length (m)

The average distance between the collector surface and the focus of the parabola. This value is not equal to the focal length of the collector. To calculate the value when you know the focal length and aperture width, use the following equation, where  $F_{avg}$  is the average surface-to-focus path length:

$$F_{avg} = w \cdot \sqrt{\frac{\left(4 \cdot a^2 + \left(\frac{w}{2}\right)^2\right)^2}{a^2}} \cdot \frac{12 \cdot a^2 + \left(\frac{w}{2}\right)^2}{12 \cdot w \cdot \left(4 \cdot a^2 + \left(\frac{w}{2}\right)^2\right)}$$

Where  $a$  is the focal length at the vertex, and  $w$  is the aperture width

### Piping distance between assemblies (m)

Length of pipes and hoses connecting collectors in a single row, not including the length of crossover pipes.

### Length of single module (m)

The length of a single collector-receiver module, equal to the collector assembly length divided by the number of modules per assembly.

## Optical Parameters

### Incidence angle modifier coefficients

Coefficients for a polynomial equation defining the incidence angle modifier equation.

Click **Edit data** and to specify coefficients for the equation. The default coefficients are for an equation with three terms, but you can use the table to specify more coefficients.

The equation captures the degradation of collector performance as the incidence angle (theta) of the solar radiation increases.

### Tracking error

Accounts for reduction in absorbed radiation error in collectors tracking caused by poor alignment of sun sensor, tracking algorithm error, errors caused by the tracker drive update rate, and twisting of the collector end at the sun sensor mounting location relative to the tracking unit end.

### Geometry effects

Accounts for errors in structure geometry caused by misaligned mirrors, mirror contour distortion caused by the support structure, mirror shape errors compared to an ideal parabola, and misaligned or distorted receiver.

### Mirror reflectance

The mirror reflectance input is the solar weighted specular reflectance. The solar-weighted specular reflectance is the fraction of incident solar radiation reflected into a given solid angle about the specular reflection direction. The appropriate choice for the solid angle is that subtended by the receiver as viewed from the point on the mirror surface from which the ray is being reflected. For parabolic troughs, typical values for solar mirrors are 0.923 (4-mm glass), 0.945 (1-mm or laminated glass), 0.906 (silvered polymer), 0.836 (enhanced anodized aluminum), and 0.957 (silvered front surface).

### Dirt on mirror

Accounts for reduction in absorbed radiation caused by soiling of the mirror surface. This value is not linked to the mirror washing variables on the [Solar Field page](#).

### General optical error

Accounts for reduction in absorbed radiation caused by general optical errors or other unaccounted error sources.

## Optical Calculations

The optical calculations are values that SAM calculates using the equations described below. You cannot directly edit these values.

Variable Name	Equation	Note
Length of single module	$= \text{Length of Collector Assembly} \div \text{Number of Modules per Assembly}$	$L_{col}$ used in End Loss at Design described below.
Incidence angle modifier at summer solstice	$= IAM_0 + \sum_{i=1}^N IAM_i \frac{\theta^i}{\cos \theta}$	Not used in actual efficiency calculation. Provided as reference only. Theta is in radians.

End loss at  
summer solstice

$$= 1 - L_{f,ave} * \tan(\theta) - \left(\frac{N_{SCA}}{2} - 1\right) * \frac{2 * EG}{N_{SCA} * L_{col}}$$

where:  
 $EG = L_{f,ave} * \tan(\theta) - L_{row\ spacing}$

Optical end loss at noon on the summer solstice due to reflected radiation spilling off of the end of the collector assembly. This value is provided as a reference and is not used in determining the design of the solar field.

Optical efficiency  
at design

$$= \text{Tracking Error} \times \text{Geometry Effects on Mirror} \times \text{Mirror Reflectance} \times \text{Dirt} \times \text{General Optical Error}$$

The collector's optical efficiency under design conditions.

## 22.5 Receivers (HCEs)

To view the Receivers page, click **Receivers (HCEs)** on the main window's navigation menu. Note that for the physical trough input pages to be available, the technology option in the [Technology and Market](#) window must be Concentrating Solar Power - Physical Trough System.

A receiver (HCE, heat collection element) is a metal pipe contained in a vacuum within glass tube that runs through the focal line of the trough-shaped parabolic collector. Seals and bellows ensure that a vacuum is maintained in each tube. Anti-reflective coatings on the glass tube maximize the amount of solar radiation that enters the tube. Solar-selective radiation absorbing coatings on the metal tube maximize the transfer of energy from the solar radiation to the pipe.

**Note.** See the Troughnet website at [http://www.nrel.gov/csp/troughnet/solar\\_field.html](http://www.nrel.gov/csp/troughnet/solar_field.html) for more information about receivers.

On the Receivers page, you define the characteristics of up to four receiver types. On the [Solar Field page](#), you specify how the different receiver types are distributed in each loop of the field, assuming that the field consists of identical loops. SAM only uses data for receiver types that you have included in the single loop specification on the Solar Field page.

For each receiver type, you also specify up to four variations. You can use the variations to describe different conditions of the receiver type. For example, you may use one variation to describe the receiver type in good condition, and another to describe the receiver type with a damaged glass envelope.

**Note.** For a detailed explanation of the physical trough model, see Wagner, M. J.; Gilman, P. (2011). *Technical Manual for the SAM Physical Trough Model*. 124 pp.; NREL Report No. TP-5500-51825. <http://www.nrel.gov/docs/fy11osti/51825.pdf> (3.7 MB)

### Input Variable Reference

## Receiver Type and Configuration Name

### Receiver Type

Choose the active receiver type (1-4). SAM displays the properties of the active receiver.

### Configuration Name

The name of library entry for the receiver type.

### Choose receiver from library

Allows you to choose a receiver from the library of available receivers.

## Receiver Geometry

### Absorber tube inner diameter (m)

Inner diameter of the receiver absorber tube, this surface in direct contact with the heat transfer fluid.

### Absorber tube outer diameter (m)

Outer diameter of the receiver absorber tube, the surface exposed to the annular vacuum.

### Glass envelope inner diameter (m)

Inner diameter of the receiver glass envelope tube, the surface exposed to the annular vacuum.

### Glass envelope outer diameter (m)

Outer diameter of the receiver glass envelope tube, the surface exposed to ambient air.

### Absorber flow plug diameter (m)

A non-zero value represents the diameter of an optional plug running axially and concentrically within the receiver absorber tube. A zero value represents a receiver with no plug. The plug allows for an increase in the receiver absorber diameter while maintaining the optimal heat transfer within the tube heat transfer fluid. For a non-zero value, be sure to use annular flow for the absorber flow pattern option.

### Internal surface roughness

The surface roughness of the inner receiver pipe surface exposed to the heat transfer fluid, used to determine flow shear force and the corresponding pressure drop across the receiver.

Surface roughness is important in determining the scale of the pressure drop throughout the system. As a general rule, the rougher the surface, the higher the pressure drop (and parasitic pumping power load). The surface roughness is a function of the material and manufacturing method used for the piping. A conservative roughness value for extruded steel pipe (the type often used for the absorber pipe) is about  $3\text{e-}6$  meters. The default value of  $4.5\text{e-}5$  m is based on this value and the absorber tube inner diameter value of 0.066 m:  $3\text{e-}6 \text{ m} / 6.6\text{e-}2 \text{ m} = 4.5\text{e-}5$ .

### Absorber flow pattern (m)

Use standard tube flow when the absorber flow plug diameter is zero. Use annular flow with a non-zero absorber flow plug diameter.

### Absorber material type

The material used for the absorber tube. Choose from stainless steel or copper.

## Parameters and Variations

### Variant weighting fraction

The fraction of the solar field that consists of the active receiver variation. For each receiver type, the sum of the four variations should equal one. See [Specifying Receiver Type Variations](#) for details.

### Absorber absorptance

The ratio of radiation absorbed by the absorber to the radiation incident on the absorber.

### Absorber emittance

The energy radiated by the absorber surface as a function of the absorber's temperature. You can either specify a table of emittance and temperature values, or specify a single value that applies at all temperatures.

### Envelope absorptance

The ratio of radiation absorbed by the envelope to the radiation incident on the envelope, or radiation that is neither transmitted through nor reflected from the envelope. Used to calculate the glass temperature. (Does not affect the amount of radiation that reaches the absorber tube.)

### Envelope emittance

The energy radiated by the envelope surface.

### Envelope transmittance

The ratio of the radiation transmitted through the glass envelope to the radiation incident on the envelope, or radiation that is neither reflected nor refracted away from the absorber tube.

### Broken glass

Option to specify that the envelope glass has been broken or removed, indicating that the absorber tube is directly exposed to the ambient air.

### Annulus gas type

Gas type present in the annulus vacuum. Choose from Hydrogen, air, or Argon.

### Annulus pressure (torr)

Absolute pressure of the gas in the annulus vacuum, in torr, where 1 torr = 133.32 Pa

### Estimated avg heat loss (W/m)

An estimated value representing the total heat loss from the receiver under design conditions. SAM uses the value to calculate the total loop conversion efficiency and required solar field aperture area for the design point values on the [Solar Field page](#). It does not use the value in simulation calculations.

### Bellows shadowing

An optical derate factor accounting for the fraction of radiation lost after striking the mechanical bellows at the ends of the receiver tubes.

### Dirt on receiver

An optical derate factor accounting for the fraction of radiation lost due to dirt and soiling on the receiver.



## Total Weighted Losses

The total weighted losses are used in the solar field sizing calculations as an estimate of the optical and thermal losses in the solar field at the design point. SAM does not use the weighted loss variables in hourly simulations.

### Heat loss at design

The total thermal loss expected from the active receiver type under design conditions accounting for the weighting fraction of the four receiver variations. SAM uses the value to calculate the design point total loop conversion efficiency and the solar field aperture area shown on the [Solar Field page](#).

### Optical derate

Represents the total optical losses expected from the active receiver type under design conditions accounting for the weighting fraction of the four receiver variations. SAM uses the value to calculate the design point total loop conversion efficiency and the solar field aperture area shown on the [Solar Field page](#).

Variable	Equation	Note
Heat loss at design	$= \sum_{i=1}^4 f_{weight,i} * \dot{q}_{h,i}$	$f_{weight,i}$ is the weighting fraction for each variation
Optical derate	$= \sum_{i=1}^4 f_{weight,i} * \eta_{bellows,i} * \eta_{rec,dirt,i} * \eta_{absorb,i} * \tau_{env,i}$	$\tau_{env,i}$ is the envelope transmittance

## Specifying Receiver Type Variations

You can use the receiver variations to model a solar field with receivers in different conditions. If you want all of the receivers in the field to be identical, then you can use a single variation and assign it a variant weighting fraction of 1.

When you use more than one receiver variation, be sure that the sum of the four variant weighting fractions is 1.

Here's an example of an application of the receiver variations for a field that consists of a two receiver types. The first type, Type 1, represents receivers originally installed in the field. Type 2 represents replacement receivers installed as a fraction of the original receivers are damaged over time.

Over the life of the project, on average, 5 percent of the Type 1 receivers have broken glass envelopes, and another 5 percent have lost vacuum in the annulus. We'll also assume that degraded receivers are randomly distributed throughout the field -- SAM does not have a mechanism for specifying specific locations of different variations of a given receiver type. To specify this situation, we would start with Type 1, and use Variation 1 to represent the 90 percent of intact receivers, assigning it a variant weighting fraction of 0.90. We'll use Variation 2 for the 5 percent of receivers with broken glass envelopes, giving it a weighting fraction of 0.05, and Variation 3 for the other 5 percent of lost-vacuum receivers with a weighting fraction of 0.05. We'll assign appropriate values to the parameters for each of the two damaged receiver variations.

Next, we'll specify Type 2 to represent intact replacement receivers. We will use a single variation for the intact Type 2 receivers.

On the Solar Field page, we'll specify the single loop configuration (assuming a loop with eight assemblies), using Type 2 for the first and second assembly in the loop, and Type 1 receivers (with the variant weighting we assigned on the Receivers page) for the remaining six assemblies in the loop.

## 22.6 Thermal Storage

### System Design Parameters

The system design parameters are from the [System Design](#) page, where you can define the design-point parameters of the entire power tower system.

**Heat sink power, MWt**

The thermal power required at the design point.

**Hours of storage at design point, hours**

The nominal thermal storage capacity expressed in hours at full load: The number of hours that the storage system can supply energy at the design point.

**HTF hot temperature, °C**

The temperature of the hot heat transfer fluid at the receiver outlet at the design point.

**HTF cold temperature, °C**

The temperature of the cold heat transfer fluid at the receiver inlet at the design point.

### Storage System

**TES thermal capacity**

The nominal thermal capacity of the storage system.

$$TES \text{ Thermal Capacity} = \text{Hours of Storage} \times \text{Cycle Thermal Power}$$

**Available HTF volume, m<sup>3</sup>**

The total volume of storage fluid in both storage tanks.

SAM calculates the total heat transfer fluid volume in storage based on the storage hours at full load and the heat sink power. The total heat transfer fluid volume is divided among the total number of tanks so that all hot tanks contain the same volume of fluid, and all cold tanks contain the same volume of fluid.

**Tank height, m**

The height of the cylinder-shaped heat transfer fluid volume in each tank.

**Tank fluid minimum height, m**

The minimum allowable height of fluid in the storage tank(s). The mechanical limits of the tank determine this value.

**Storage tank volume, m<sup>3</sup>**

The volume of a single storage tank.

**Parallel tank pairs**

The number of parallel hot-cold storage tank pairs. Increasing the number of tank-pairs also increases the volume of the heat transfer fluid exposed to the tank surface, which increases the total tank thermal losses. SAM divides the total heat transfer fluid volume among all of the tanks, and assumes that each hot tank contains an equal volume of fluid, and each cold tank contains an equal volume.

**Tank diameter, m**

The diameter of the cylinder-shaped heat transfer fluid volume in each storage tank.

**Wetted loss coefficient, W/m<sup>2</sup>/K**

The thermal loss coefficient that applies to the portion of the storage tank holding the storage heat transfer fluid.

**Estimated heat loss, MWt**

Heat loss from the storage system at the design-point.

**Initial Hot HTF Percent, %**

The fraction of the storage heat transfer fluid in the hot storage tank at the beginning of the simulation.

**Cold tank heater temperature set point, °C**

The minimum allowed cold tank temperature. Whenever the heat transfer fluid temperature in storage drops below the set-point value, the system adds sufficient thermal energy from an electric tank heater to storage to reach the set-point.

**Cold tank heater capacity, MWe**

The maximum electric load of the cold tank electric heater.

**Hot tank heater temperature set point, °C**

The minimum allowed hot tank temperature. Whenever the heat transfer fluid temperature in storage drops below the set-point value, the system adds sufficient thermal energy from an electric tank heater to storage to reach the set-point.

**Hot tank heater capacity, MWe**

The maximum electric load of the hot tank electric heater.

**Tank heater efficiency**

The electric-to-thermal conversion efficiency of the hot tank and cold tank heaters.

**HTF density**

The density of the storage fluid.

## 22.7 System Control

The System Control inputs determine the operating parameters of the system.

**Note.** The physical trough and molten salt power tower models in SAM use a new power cycle and system dispatch model that does not support thermocline storage or fossil backup because they were not incorporated into the new dispatch controller logic. If you want to use those features, you can use the legacy version SAM 2015.6.30, available on the SAM website [Download page](#).

### Plant Energy Consumption

**Fraction of gross power consumed at all times, MWe/MWcap**

A fixed electric load applied to all hours of the simulation, expressed as a fraction of rated gross power

at design from the [System Design](#) page.

### Balance of Plant Parasitic, MWe/MWcap

Losses as a fraction of the power block nameplate capacity that apply in hours when the power block operates.

### Aux heater boiler parasitic (MWe/MWcap)

A parasitic load that is applied as a function of the thermal output of the auxiliary fossil-fired heaters.

The BOP and auxiliary heater parasitic at design are calculated as follows:

$$\text{Parasitic Loss (MWe)} = P \text{ (MWe/MWcap)} \times F \times (C0 + C1 + C2) \times \text{Design Turbine Gross Output (MWe)}$$

## System Availability

System availability losses are reductions in the system's output due to operational requirements such as maintenance down time or other situations that prevent the system from operating as designed.

**Note.** To model curtailment, or forced outages or reduction in power output required by the grid operator, use the inputs on the [Grid Limits](#) page.

To edit the system availability losses, click **Edit losses**.

The [Edit Losses](#) window allows you to define loss factors as follows:

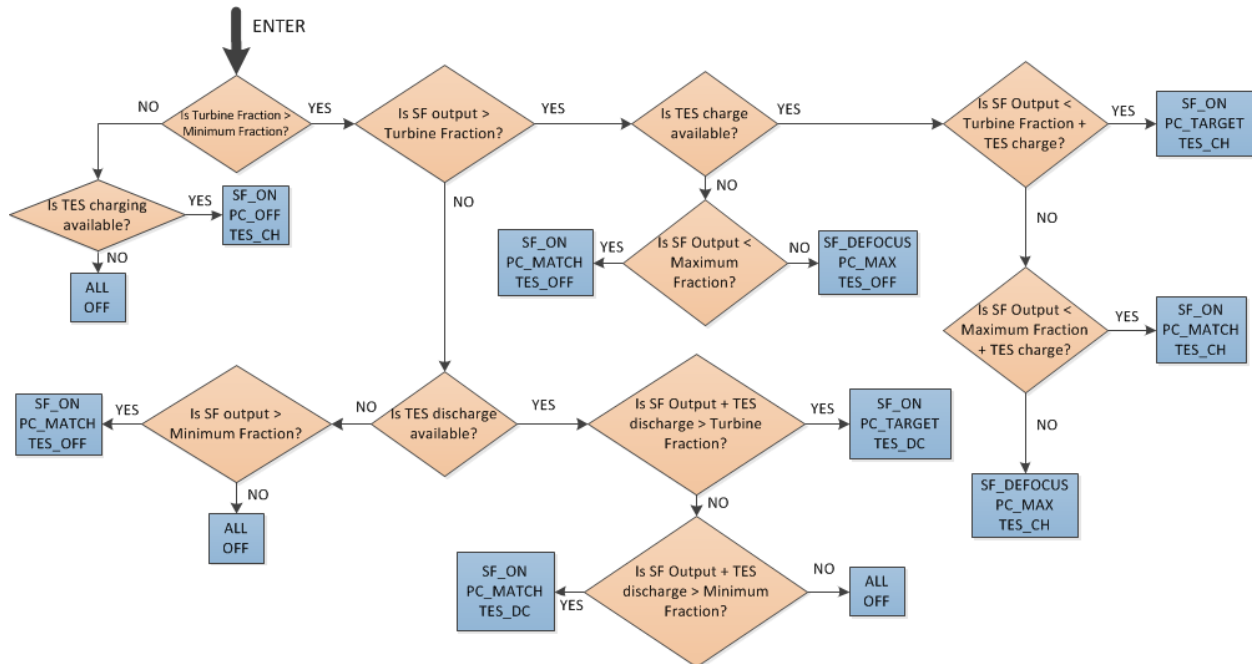
- Constant loss is a single loss factor that applies to the system's entire output. You can use this to model an availability factor.
- Hourly losses apply to specific hours of the year.

SAM reduces the system's output in each hour by the loss percentage that you specify for that hour. For a given hour, a loss of zero would result in no adjustment. A loss of 5% would reduce the output by 5%, and a loss of -5% would increase the output value by 5%. For subhourly simulations, SAM applies the loss factor for a given hour to each time step in that hour

## Dispatch Optimization

The dispatch algorithm determines the timing of energy delivery from the solar field and to and from the thermal energy storage system. When the field is producing more thermal power than required by the power cycle during times when storage is full, the algorithm defocuses heliostats in the field to reduce the field output power. SAM reports the field optical focus fraction, receiver incident thermal power, TES charge state, and other variables in the [Results](#) that you can use to see how the system operates.

When you enable dispatch optimization, SAM automatically determines when the system defocuses heliostats in the field, stores thermal energy from the solar field, or when it dispatches thermal energy from the thermal energy storage system to the power cycle.



When you run a simulation without enabling optimization, SAM attempts to operate the system so that the power cycle output matches the dispatch schedule you define. If the turbine dispatch fraction for a given time step is greater than the minimum turbine fraction and the storage system is full, it will dispatch energy to the power cycle up to the turbine output fraction for that time step, and defocus the field if the field thermal power output exceeds the amount required.

#### Enable dispatch optimization

Check the box to enable automatic optimization.

#### Time horizon for dispatch optimization

The time period that SAM uses as a basis for the optimization. Default value is 48 hours.

#### Frequency for dispatch reoptimization

The time period to determine how often SAM runs the optimization. Default value is 24 hours.

#### Cycle startup cost penalty, \$/start

The penalty in the dispatch optimization algorithm associated with starting up the power cycle. The cost is applied any time the power cycle goes from an “off” state to an “on” or “standby” state in the next time period. This penalty affects the optimal solution, which seeks to maximize revenue. This value *does not* affect actual O&M costs or the calculated SAM financial metrics.

#### Receiver startup cost penalty, \$/start

The penalty in the dispatch optimization algorithm associated with starting up the solar field and receiver. The cost is applied any time the solar field goes from an “off” state to an “on” state in the next time period. This penalty affects the optimal solution, which seeks to maximize revenue. This value *does not* affect actual O&M costs or the calculated SAM financial metrics.

#### Power generation ramping penalty

The penalty imposed for changing power cycle electrical production from one time step to the next. By penalizing changes, the resulting dispatch profile exhibits improved stability and is potentially more realizable in practice. Increasing this penalty may reduce achieved revenue for the project. This penalty

affects the optimal solution, which seeks to maximize revenue. This value does not affect actual O&M costs or the calculated SAM financial metrics.

#### **Objective function time weighting exponent**

The relative weight due to time in the dispatch optimization objective function. A weighting factor of 0.99 indicates that the objective function terms are multiplied by  $0.99^t$  for each timestep  $t$  in the optimization horizon (48 hours, by default). A value of 1.0 indicates no time weighting, a value less than one indicates that – all things equal – generation is preferred sooner than later, and a value greater than one indicates that generation is preferred later than sooner. As the value is displaced from unity, the optimization algorithm is typically able to solve the dispatch problem more quickly, but the resulting revenue may decrease. Note that a value of 0.99 corresponds to an objective discounting in the 24th time period (one day ahead) of  $0.99^{24} = 0.79$ , which is to say that the optimization routine values revenue generated in hour one 21% more than in hour 24, though revenue multipliers and efficiency terms may be identical.

#### **Maximum branch and bound iterations**

Limits the number of iterations in the optimization routine. If you are experiencing problems with the optimization, you can increase the number. The default value is 30,000.

#### **Solution optimality gap tolerance**

Determines the tolerance for the optimization solution. You can decrease the tolerance if you are experiencing problems with the optimization. Default value is 0.001.

#### **Optimization solver timeout limit, seconds**

Limits the amount of time the optimization will attempt to find a solution. You can increase the timeout limit if you are experiencing problems with the optimization. Default value is 5 seconds.

#### **Max. net power to the grid (MWe)**

The maximum allowable net power to the grid when running dispatch optimization. Use a value much greater than the power cycle nameplate capacity to remove the effect of this constraint.

SAM determines approximate parasitic loads and the approximate gross cycle generation at each time period in the forecast horizon, and limits the net output to be less than or equal to this value. If the net power production cannot reach the specified limit, either because insufficient energy is available for power generation or because the power cycle operation envelope does not allow for sufficiently high output, the constraint will not be applied.

#### **Max. net power to the grid (incl. availability), MWe**

A calculated value that indicates the max. net power to the grid after power cycle availability losses are accounted for. The calculated value is the product of the max.net power to the grid and the constant term in the [Edit Losses](#) window on the System Control page. Note that hourly or hourly-block availability options are not included in this calculation, and only the constant is considered. When running a simulation with dispatch optimization enabled and the maximum power constraint in effect, the net production in the hourly data viewer will most closely equal this calculated value.

## **Dispatch Control**

The dispatch control periods determine the timing of adjustments to the power cycle output.

**Note.** If your analysis involves PPA price multipliers defined on the [Time of Delivery \(TOD\) Factors](#) page, you should verify that the dispatch control schedules are consistent with the TOD factor schedules.

**Use output fraction as maximum cycle output**

Check this box if you want to limit the power cycle output to the turbine output fraction you specify for dispatch control instead of the **Maximum turbine over design operation** on the Power Cycle page. If you do not check the box and the turbine over design operation is greater than the highest turbine output fraction, the power cycle may operate at the higher value, exceeding the maximum dispatch limit under some conditions.

**Turbine output fraction**

For each of up to nine time-of-delivery periods, specify a multiple of the power cycle thermal input to scale the system's electrical output up or down as desired to match power pricing schedules or other time-dependent constraints.

**Hybrid cooling fraction**

For each of up to nine time-of-delivery periods, specify how much of the cooling load should be handled by the wet-cooling system. Each value in the table is a fraction of the design cooling load. For example, if you want 60% of heat rejection load to go to wet cooling in Period 1, type 0.6 for Period 1. Directing part of the heat rejection load to the wet cooling system reduces the total condenser temperature and improves performance, but increases the water requirement. SAM sizes the wet-cooling system to match the maximum fraction that you specify in the hybrid dispatch table, and sizes the air-cooling system to meet the full cooling load.

**Defining Dispatch Schedules**

The storage dispatch schedules determine when each of the nine periods apply during weekdays and weekends throughout the year.

If your analysis includes [PPA price multipliers](#) and you want to use the same schedule for the multipliers and for the power cycle dispatch control, click **Copy schedule from TOD Factors** page to apply the TOD Factors schedule matrices to the dispatch schedule matrices.

**To specify a weekday or weekend schedule:**

1. Assign values as appropriate to the **Turbine output fraction** and **Hybrid cooling fraction** for each of the up to nine periods.
2. Use your mouse to draw a rectangle in the matrix for the first block of time that applies to period 2.

	12am	1am	2am	3am	4am	5am	6am	7am	8am	9am	10am	11am	12pm	1pm	2pm	3pm	4pm	5pm	6pm	7pm	8pm	9pm	10pm	11pm
Jan	1	1	1	1	1	1	1	1	1	1	1	1	1	1	1	1	1	1	1	1	1	1	1	1
Feb	1	1	1	1	1	1	1	1	1	1	1	1	1	1	1	1	1	1	1	1	1	1	1	1
Mar	1	1	1	1	1	1	1	1	1	1	1	1	1	1	1	1	1	1	1	1	1	1	1	1
Apr	1	1	1	1	1	1	1	1	1	1	1	1	1	1	1	1	1	1	1	1	1	1	1	1
May	1	1	1	1	1	1	1	1	1	1	1	1	1	1	1	1	1	1	1	1	1	1	1	1
Jun	1	1	1	1	1	1	1	1	1	1	1	1	1	1	1	1	1	1	1	1	1	1	1	1
Jul	1	1	1	1	1	1	1	1	1	1	1	1	1	1	1	1	1	1	1	1	1	1	1	1
Aug	1	1	1	1	1	1	1	1	1	1	1	1	1	1	1	1	1	1	1	1	1	1	1	1
Sep	1	1	1	1	1	1	1	1	1	1	1	1	1	1	1	1	1	1	1	1	1	1	1	1
Oct	1	1	1	1	1	1	1	1	1	1	1	1	1	1	1	1	1	1	1	1	1	1	1	1
Nov	1	1	1	1	1	1	1	1	1	1	1	1	1	1	1	1	1	1	1	1	1	1	1	1
Dec	1	1	1	1	1	1	1	1	1	1	1	1	1	1	1	1	1	1	1	1	1	1	1	1

3. Type the number 2.

	12am	1am	2am	3am	4am	5am	6am	7am	8am	9am	10am	11am	12pm	1pm	2pm	3pm	4pm	5pm	6pm	7pm	8pm	9pm	10pm	11pm
Jan	1	1	1	1	1	1	1	1	1	1	1	1	1	1	1	1	1	1	1	1	1	1	1	1
Feb	1	1	1	1	1	1	1	1	1	1	1	1	1	1	1	1	1	1	1	1	1	1	1	1
Mar	1	1	1	1	1	1	1	1	1	1	1	1	1	1	1	1	1	1	1	1	1	1	1	1
Apr	1	1	1	1	1	1	1	1	1	1	1	1	1	1	1	1	1	1	1	1	1	1	1	1
May	1	1	1	1	1	1	1	1	1	1	2	2	2	2	2	2	1	1	1	1	1	1	1	1
Jun	1	1	1	1	1	1	1	1	1	1	2	2	2	2	2	2	1	1	1	1	1	1	1	1
Jul	1	1	1	1	1	1	1	1	1	1	2	2	2	2	2	2	1	1	1	1	1	1	1	1
Aug	1	1	1	1	1	1	1	1	1	1	2	2	2	2	2	2	1	1	1	1	1	1	1	1
Sep	1	1	1	1	1	1	1	1	1	1	1	1	1	1	1	1	1	1	1	1	1	1	1	1
Oct	1	1	1	1	1	1	1	1	1	1	1	1	1	1	1	1	1	1	1	1	1	1	1	1
Nov	1	1	1	1	1	1	1	1	1	1	1	1	1	1	1	1	1	1	1	1	1	1	1	1
Dec	1	1	1	1	1	1	1	1	1	1	1	1	1	1	1	1	1	1	1	1	1	1	1	1

- SAM shades displays the period number in the squares that make up the rectangle, and shades the rectangle to match the color of the period.

**Dispatch Control**

[Copy schedule from TOD Factors page](#)

Use the schedule matrices to specify the month and hour of day for each of the nine periods.

**Turbine output fraction**

Period 1:

Period 2:

Period 3:

Period 4:

Period 5:

Period 6:

Period 7:

Period 8:

Period 9:

The turbine output fraction scales the turbine thermal input relative to design for the corresponding time-of-use period.

**Weekday Schedule**

	12am	1am	2am	3am	4am	5am	6am	7am	8am	9am	10am	11am	12pm	1pm	2pm	3pm	4pm	5pm	6pm	7pm	8pm	9pm	10pm	11pm
Jan	1	1	1	1	1	1	1	1	1	1	1	1	1	1	1	1	1	1	1	1	1	1	1	1
Feb	1	1	1	1	1	1	1	1	1	1	1	1	1	1	1	1	1	1	1	1	1	1	1	1
Mar	1	1	1	1	1	1	1	1	1	1	1	1	1	1	1	1	1	1	1	1	1	1	1	1
Apr	1	1	1	1	1	1	1	1	1	1	1	1	1	1	1	1	1	1	1	1	1	1	1	1
May	1	1	1	1	1	1	1	1	1	1	2	2	2	2	2	2	1	1	1	1	1	1	1	1
Jun	1	1	1	1	1	1	1	1	1	1	2	2	2	2	2	2	1	1	1	1	1	1	1	1
Jul	1	1	1	1	1	1	1	1	1	1	2	2	2	2	2	2	1	1	1	1	1	1	1	1
Aug	1	1	1	1	1	1	1	1	1	1	2	2	2	2	2	2	1	1	1	1	1	1	1	1
Sep	1	1	1	1	1	1	1	1	1	1	1	1	1	1	1	1	1	1	1	1	1	1	1	1
Oct	1	1	1	1	1	1	1	1	1	1	1	1	1	1	1	1	1	1	1	1	1	1	1	1
Nov	1	1	1	1	1	1	1	1	1	1	1	1	1	1	1	1	1	1	1	1	1	1	1	1
Dec	1	1	1	1	1	1	1	1	1	1	1	1	1	1	1	1	1	1	1	1	1	1	1	1

- Repeat Steps 2-4 for each of the remaining periods that apply to the schedule.

## Operating Modes

The power tower model reports a set of operating mode outputs indicating how the system operates in each time step. The controller may divide a time step into different operating modes. For example the startup time step may involve three operating modes: Operating Mode 2 as the receiver warms up and the power cycle is off, followed by Operating Mode 32 when the receiver is on and hot HTF is delivered to both the power cycle for startup and TES, and then by Operating Mode 11 when the receiver is on and hot HTF is delivered to both the power cycle for power generation and TES for charging. The controller reports the first three operating modes and the number of modes for each time step. Most time steps will require three or fewer modes. In some rare cases, a time step may require more than three modes.

The operating modes output variables are:

### 1st operating mode

The operating mode at the beginning of the time step.

December 2020



**2nd op. mode, if applicable**

If the operating mode changes within the time step, the second operating mode follows the first operating mode.

**3rd op mode, if applicable**

If the operating mode changes three times within the time step, the third operating mode follows the second operating mode.

**Operating modes in reporting timestep**

The number of operating modes in a given time step.

In each time step, the power tower plant controller uses an iterative process to search for the operating mode that best achieves target plant output. The target plant output is either determined from the **Turbine output fraction** for the time step that you specify under **Dispatch Control**, or, if you check **Enable dispatch optimization** under **Dispatch Optimization**, it is automatically optimized. For example, for a time step when the receiver output power is very close to but slightly less than the thermal power required for the power cycle to generate power at the target level, the controller might try Operating Mode 11 where the receiver delivers hot HTF to both the power cycle and TES and determine that is not enough energy to meet the cycle target. The controller would then it try Operating Mode 12 that discharges a small amount of energy from TES to supplement the energy from the receiver and meet the cycle target. If the cycle target is met, the **First 3 operating modes tried** would be 1112 to represent the controller trying Operating Mode 11 followed by Operating Mode 12.

In most cases, the controller will only need to consider up to three attempts, and it reports up to nine attempts. The output variables indicating operating modes considered by the controller are listed below. Note that modes 1-9 are indicated as 10, 20, 30, ... 90.

**First 3 operating modes tried**

The numbers of the first of up to three operating modes tested in a given time step to find the best operating mode. For example, if operating modes 11 and 12 were tried, the value would be 1112.

**Next 3 operating modes tried**

If the controller tried more than three operating modes, the mode numbers up to three additional attempts.

**Final 3 operating modes tried**

If the controller tried more than six operating modes, the mode numbers for up to three additional attempts.

The 34 operating modes are described in the table below. Note that single digit operating modes 1-9 are shown as 10, 20, etc. in the "operating modes tried" variables.

Operating Mode	Description
1 (10)	CR_OFF, PC_OFF, TES_OFF, AUX_OFF
2 (20)	CR_SU, PC_OFF, TES_OFF, AUX_OFF
3 (30)	CR_ON, PC_SU, TES_OFF, AUX_OFF
4 (40)	CR_ON, PC_SB, TES_OFF, AUX_OFF
5 (50)	CR_ON, PC_RM_HI, TES_OFF, AUX_OFF
6 (60)	CR_ON, PC_RM_LO, TES_OFF, AUX_OFF
7 (70)	CR_DF, PC_MAX, TES_OFF, AUX_OFF
8 (80)	CR_OFF, PC_SU, TES_DC, AUX_OFF
9 (90)	CR_ON, PC_OFF, TES_CH, AUX_OFF
10	SKIP_10 (not used)
11	CR_ON, PC_TARGET, TES_CH, AUX_OFF
12	CR_ON, PC_TARGET, TES_DC, AUX_OFF
13	CR_ON, PC_RM_LO, TES_EMPTY, AUX_OFF
14	CR_DF, PC_OFF, TES_FULL, AUX_OFF
15	CR_OFF, PC_SB, TES_DC, AUX_OFF
16	CR_OFF, PC_MIN, TES_EMPTY, AUX_OFF
17	CR_OFF, PC_RM_LO, TES_EMPTY, AUX_OFF
18	CR_ON, PC_SB, TES_CH, AUX_OFF
19	CR_SU, PC_MIN, TES_EMPTY, AUX_OFF
20	SKIP_20 (not used)
21	CR_SU, PC_SB, TES_DC, AUX_OFF
22	CR_ON, PC_SB, TES_DC, AUX_OFF
23	CR_OFF, PC_TARGET, TES_DC, AUX_OFF
24	CR_SU, PC_TARGET, TES_DC, AUX_OFF
25	CR_ON, PC_RM_HI, TES_FULL, AUX_OFF
26	CR_ON, PC_MIN, TES_EMPTY, AUX_OFF
27	CR_SU, PC_RM_LO, TES_EMPTY, AUX_OFF
28	CR_DF, PC_MAX, TES_FULL, AUX_OFF
29	CR_ON, PC_SB, TES_FULL, AUX_OFF
30	SKIP_30 (not used)
31	CR_SU, PC_SU, TES_DC, AUX_OFF
32	CR_ON, PC_SU, TES_CH, AUX_OFF
33	CR_DF, PC_SU, TES_FULL, AUX_OFF
34	CR_DF, PC_SU, TES_OFF, AUX_OFF

## 23 IPH Linear Direct Steam

The industrial process heat parabolic trough model is similar to the [CSP linear Fresnel](#) model, but assumes that heat from the solar field is used for a thermal application rather than to drive a power cycle for electricity generation. It is for a solar field of parabolic linear Fresnel concentrating collectors.

### 23.1 Location and Resource

The Location and Resource page provides access to the solar resource library, which is a collection of weather files stored on your computer. When you first install SAM, it comes with a few default weather files in the library. As you use SAM for your own projects, you should add files to build your own library. Once files are in your library, you can use them for different projects and with different versions of SAM.

The screenshot shows the 'Solar Resource Library' window. At the top, it says 'The Solar Resource library is a list of weather files stored on your computer. You can search for a file, or use the tools below to add files to the library.' Below this is a search bar and a 'Name' field. A table lists three weather files with columns for Name, Latitude, Longitude, Time zone, Elevation, and Station ID. A green callout box points to the table with the text 'Choose a weather file from the library.' Below the table, it says 'SAM scans the following folders on your computer for valid weather files to add to the source library. To use weather files stored on your computer, add folders containing the files.' A list of folders is shown: 'C:\Users\<user>\SAM Downloaded Weather Files', 'F:\little\_rock\_ar', and 'F:\PVGIS 5'. A green callout box points to this list with the text 'List of solar resource folders.' To the right of the folder list are two buttons: 'Add/remove weather file folders...' and 'Refresh library'.

Name	Latitude	Longitude	Time zone	Elevation	Station ID
daggett_ca_34.865371_-116.783023_psmv3_60_tmy	34.85	-116.78	-8	561	91486
des_moines_ia_41.586835_-93.624959_psmv3_60_tmy	41.57	-93.62	-6	263	757516
faroo_nd_46.9_-96.8_mts1_60_tmy	46.9	-96.8	-6	274	14914

**Weather Data Information**  
The following information describes the weather file used in the Solar Resource library above. This is the file SAM will use when you click Simulate.

Weather file:  [View data](#)

**-Header Data from Weather File-**

City	-	Station ID	<input type="text" value="91486"/>	Latitude	<input type="text" value="34.85 *N"/>
State	-	Data Source	<input type="text" value="NSRDB"/>	Longitude	<input type="text" value="-116.78 *E"/>
Country	-	Elevation	<input type="text" value="561 m"/>	Time zone	<input type="text" value="GMT -8"/>

**-Annual Averages Calculated from Weather File Data-**

Global horizontal	<input type="text" value="NaN"/>	kWh/m <sup>2</sup> /day	Average temperature	<input type="text" value="17.3"/>	°C
Direct normal (beam)	<input type="text" value="7.65"/>	kWh/m <sup>2</sup> /day	Average wind speed	<input type="text" value="2.4"/>	m/s
Diffuse horizontal	<input type="text" value="1.27"/>	kWh/m <sup>2</sup> /day	*NaN indicates missing data.		

**Weather file for simulation.**

**Information from weather file header.**

**Summary data calculated from time series data.**

There are two ways to add files to your solar resource library:

### 1. Download files from the NREL National Solar Radiation Database (NSRDB)

Use the download weather file options and click **Download and add to library** to get the most up-to-date data from the NSRDB for long-term cash flow analysis, single-year analysis, and P50/P90 analysis.

### 2. Add weather file folders

If you have weather files from a source other than the NSRDB or that you've downloaded yourself directly from the NSRDB website, click **Add/remove weather file folders** to add the folder containing the files to the **Solar Data File Folders** list. SAM automatically adds any weather files it finds in these folders to the solar resource library so they will appear in the list.

When you install SAM, it creates the default download folder *<user>/SAM Downloaded Weather Files* folder where weather files you download from the NSRDB are stored. You can change that folder by clicking **Add/remove weather file folders** and changing the **Folder for Downloaded Solar Data Files**.

For locations not in the NSRDB, you can download weather files in the EPW format from the European Commission Photovoltaic Geographical Information System [PVGIS V5 website](#).

### See also

- [Weather File Formats](#)
- [Weather Data Elements](#)
- [Typical and Single Year](#)
- [Time and Sun Position](#)
- [Folders and Libraries](#)
- [Weather Data and LK](#)

**Notes.**

You may want to model your system using weather data from several different sources and locations around your project site to understand how sensitive your analysis results are to the weather assumptions, and how much variation there is in the data from the different weather files.

You can compare results for a system using more than one weather file in a single case by using SAM's [parametric simulation](#) option.

For more information about weather data, including where to find data for locations outside of the United States, see [Weather Data](#) on the SAM website.

For a helpful discussion of weather data and power system simulation, see Sengupta, M.; Habte, A.; Gueymard, C.; Wilbert, S.; Renne, D.; Stoffel, T. (2017). "Best Practices Handbook for the Collection and Use of Solar Resource Data for Solar Energy Applications: Second Edition." NREL Report No. TP-5D00-68886. ([PDF 8.1 MB](#))

## ▼ Solar Resource Library

SAM's solar resource library displays information from weather files in your solar resource data folders. The default solar resource library that comes with SAM contains weather files for a few locations around the United States for the default configurations. As you use SAM, use **Add/remove weather file folders** to build a library of files for locations you frequently use as described in [Folders and Libraries](#).

### To choose a file from the solar resource library:

- Click the location name in the list. You can type a few letters of the file name in the Search box to filter the list.

The full file name and information about the selected file appears under **Weather Data Information**. To see the data in the file, click **View data**.

The screenshot shows the 'Solar Resource Library' window. At the top, it says 'The Solar Resource library is a list of weather files on your computer, or use the tools below to add files to the library.' Below this is a search box. The main area is a table with the following data:

Name	Latitude	Longitude	Time zone	Elevation	Station ID
daggett_ca_34.865371_-116.783023_psmv3_60_tmy	34.85	-116.78	-8	561	91486
des_moines_ia_41.586835_-93.624959_psmv3_60_tmy	41.57	-93.62	-6	263	757516
faroo nd 46.9 -96.8 mts1 60 tmy	46.9	-96.8	-6	274	14914

Below the table, it says 'SAM scans the following folders on your computer for valid weather files to add to the solar resource library. To use weather files stored on your computer, add folders containing the files.' Below this is a list of folders:

- C:\Users\<user>\SAM Downloaded Weather Files
- F:\little\_rock\_ar
- F:\PVGIS 5

At the bottom right, there are two buttons: 'Add/remove weather file folders...' and 'Refresh library'.

### **Add/remove weather file folders**

Use the folder settings to tell SAM what folders on your computer it should scan for weather files to build the solar resource library. SAM adds any files it can identify as valid weather files in each folder you specify to the library.

Before adding a file to the library, SAM checks the data in the file displays a message if it finds any problems with the data in the file.

SAM will only add valid weather files to the library. If you add a folder that contains CSV files that are not in the SAM CSV format, it will not add those files to the library.

The list of solar resource folders are the folders that SAM scans for weather files to build the solar resource library.

### Refresh library

Refresh the library after adding files to the weather file folder. In most cases, SAM should automatically refresh the library as needed, but you may need to manually refresh it.

## Download Weather Files

SAM can download weather files from the latest National Solar Radiation Database (NSRDB) Physical Solar Model (PSM) datasets. For all NSRDB datasets, SAM can download single-year files or typical-year files.

**Download Weather Files**  
Download the latest weather files from the NSRDB to add to your solar resource library: Download a typical-year (TMY) file for most long-term cash flow analyses, or choose files to download for single-year or P50/P90 analyses. See Help for details.

One location     Multiple locations     60-minute     30-minute     Legacy data (advanced)

Type a street address or latitude, longitude (skip for advanced)    Default TMY file    Download and add to library...

[Go to SAM website Weather Page for information about NSRDB and PVGIS, and for links to other sources of solar resource data](#)

**Note.** For locations not in the NSRDB, you can download EPW files from the European Commission Photovoltaic Geographical Information System [PVGIS V5 website](#) to a folder on your computer, and then use the [folder settings window](#) to add the folder to the list of folders SAM scans to build the solar resource library.

### To download a typical-year weather file for a single location:

1. Replace the text "Type a location name, street address or latitude and longitude" with a street address, city and state or country name, zip code, or latitude longitude pair. For example:
  - Golden, Colorado
  - golden, co
  - 15013 Denver West Parkway, Golden CO 80401
  - 80401
  - thimpu, bhutan
2. Click **Download and add to library**.

For more instructions to download multiple files, see [Weather File Download Instructions](#) below.

SAM converts the address you type to a latitude and longitude pair for the location, and submits that information to the NSRDB along with your email address. If the location is in the region covered by the NSRDB, it returns a weather file in the SAM CSV format, and adds it to your weather file download folder. Otherwise, it displays a message telling you the location is not covered by the NSRDB.

When you first install SAM, it creates the *SAM Downloaded Weather Files* folder and assigns it as your weather file download folder. You can change the weather file download folder by clicking **Add/Remove**

**weather file folders.** See [Folders and Libraries](#) for details.

When the download finishes, SAM displays a prompt asking you if you want to open the weather file download log. This prompt is the indication that the download finished. During the download and before that prompt appears, SAM may become unresponsive. If it does, wait for the prompt to avoid interrupting the download.

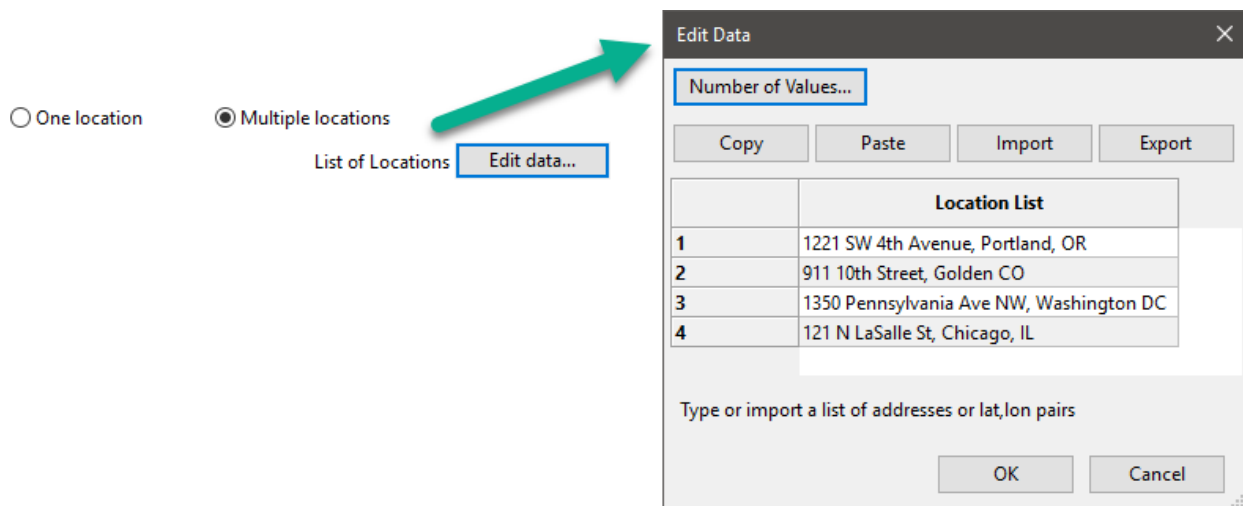
The weather file download log is a text file that SAM creates in your weather file download folder, and serves as a record of all of the files you download from the NSRDB. For each download, it lists the date and time of the request, the information you provided, the URL SAM generated, the name of the file returned by the NSRDB, or error messages it returns if the download fails. This information is useful for troubleshooting weather file download problems.

**Note.** Downloading multiple weather files from the NSRDB can take a long time. If you download files for multiple locations or years, be prepared to wait for the files to download. The download log file reports the time it takes for each file to download. Download times depend on your internet connection and computer. For a new computer with a fast connection, downloading and processing a single file takes about 10 seconds.

### One location, Multiple locations

Choose **One location** to download a weather file for a single location.

Choose **Multiple locations** to submit a list of locations and download a file or files for each location. For Multiple locations, click **Edit data** to open the Edit Data window where you can enter the list of locations and click **Number of Values** to enter the number of locations in the list.

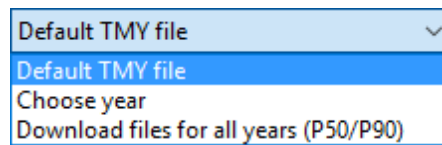


### 60-minute, 30-minute

Choose **60-minute** to download weather files with hourly time steps or 8,760 data records.

Choose **30-minute** to download files with 30-minute time steps or 17,520 data records. Thirty-minute data is not available for the NSRDB SUNY International dataset.

## Download options



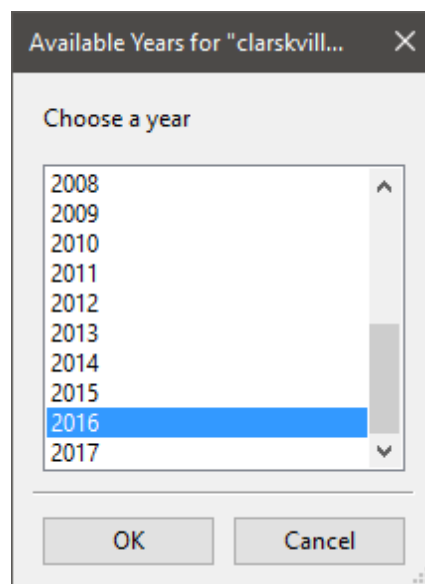
### Default TMY file

Download a typical meteorological year weather file for the location or locations you specified.

Typical year data is appropriate when you are using simulation results for a single year to make cash flow calculations over a multi-year period.

### Choose year

Choose a single year file to download. After you click the Download button, SAM prompts you with a list of available years for each location you requested to choose a year.



The single year option is appropriate when you want to see how the system would perform in a particular year. For example, for a residential or commercial system, if you have measured building load data for a given year, you could use weather data for the same year to see how the system's power output compares to the load.

If you use both **Choose year** and **Multiple locations**, SAM prompts you for a year for each location.

SAM queries the NSRDB to generate the list of available years. The list of available years varies between regions.

### Download files for all years (P50/P90)

Download a set of single-year files covering the range of historical data (nineteen files for 1998 through 2017 as of October 2018 for PSM data). When you click download, SAM creates a folder in your weather file download folder to store the single year files based on the location address or latitude-longitude pair you typed. It also downloads the typical meteorological year (TMY) file for the location and stores it in your weather file download folder.

SAM appends an underscore with the year to the file name so that the P50 P90 simulations work



correctly. See [P50/P90 Simulations](#) for details.

If you choose to download files for all years with **Multiple locations**, SAM downloads a set of files for each location, and puts the files for each location in a separate folder. Note that this may take a long time.

## Weather File Download Instructions

### Examples of valid street address or latitude-longitude pairs:

- golden colorado
- golden, co
- 15013 Denver West Parkway, Golden CO 80401
- 80401
- 39.75, -105.15
- Super Market, F-6 Markaz, Islamabad, Pakistan
- New Delhi, India

**Note.** When the download finishes, SAM displays a prompt asking you if you want to open the weather file download log. This prompt is the indication that the download finished. During the download and before that prompt appears, SAM may become unresponsive. If it does, wait for the prompt to avoid interrupting the download.

### To download an hourly typical-year (TMY) weather file from the NSRDB (use this option for most situations):

1. Click **One location**.
2. Type either a street address or latitude-longitude pair.
3. Click **60-minute**.
4. Choose **Default TMY File**.
5. Click **Download and add to library**.

### To download files for more than one location:

1. Click **Multiple locations**.
2. Click **Edit data**.
3. In the Edit Data window, click **Number of Values** and type the number of locations to create a table with a row for each location.
4. Type a street address or latitude-longitude pair in the table for each location.
5. Click **OK**.
6. Choose a time step, **60-minute** for hourly, or **30-minute** for 30-minute data.
7. Choose the type of file(s) you want to download as described below.
8. Click **Download and add to library**.

## Weather Data Information

**Weather Data Information**  
The following information describes the weather file in the Solar Resource library above. This is the file SAM will use when you click Simulate.

Weather file:  [View data](#)

**-Header Data from Weather File-**

City	<input type="text" value="-"/>	Station ID	<input type="text" value="91486"/>	Latitude	<input type="text" value="34.85 *N"/>
State	<input type="text" value="-"/>	Data Source	<input type="text" value="NSRDB"/>	Longitude	<input type="text" value="-116.78 *E"/>
Country	<input type="text" value="-"/>	Elevation	<input type="text" value="561 m"/>	Time zone	<input type="text" value="GMT -8"/>

**-Annual Averages Calculated from Weather File Data-**

Global horizontal	<input type="text" value="NaN"/>	kWh/m <sup>2</sup> /day	Average temperature	<input type="text" value="17.3"/>	°C
Direct normal (beam)	<input type="text" value="7.65"/>	kWh/m <sup>2</sup> /day	Average wind speed	<input type="text" value="2.4"/>	m/s
Diffuse horizontal	<input type="text" value="1.27"/>	kWh/m <sup>2</sup> /day	*NaN indicates missing data.		

### Weather File

The path and name of the active weather file SAM will use for simulation. Download a different file from the NSRDB, or click a different file name in the library to change the file.

### View data

Display weather file data in the [time series data viewer](#).

**Note.** You can also see the data after running a simulation on the Results page [data tables](#) and [time series graphs](#).

### Header Data from Weather File

Header data is information in the weather file that describes the location and type of data in the file. SAM uses the time zone, elevation, latitude and longitude to calculate the sun position during simulations. It does not use the city, state, country, and other descriptive information.

### Annual Values Calculated from Weather File

When you add a weather file to the solar resource library, SAM reads weather data from the file and calculates the annual values to display for your reference. It does not use annual values during simulations.

#### Global horizontal, Direct normal (beam), Diffuse horizontal

The sum of solar irradiance data (W/m<sup>2</sup>) in the weather file converted to kW and divided by 365 days/year.

#### Average temperature

The sum of temperature data (°C) in the weather file divided by the number of records in the file (8760 for hourly data).

#### Average wind speed

The sum of wind speed data (m/s) in the weather file divided by the number of records in the file (8760 for hourly data).

### Maximum snow depth

If the weather file contains snow depth data, the maximum value of snow depth data (cm) in the weather file. NaN indicates the file does not contain snow depth data. Snow depth data is required for to model snow losses for the Detailed Photovoltaic and PVWatts models.

**Note.** For information about where to find weather files with snow depth data, see the note on the [Weather Data](#) page of the SAM website.

### Annual albedo

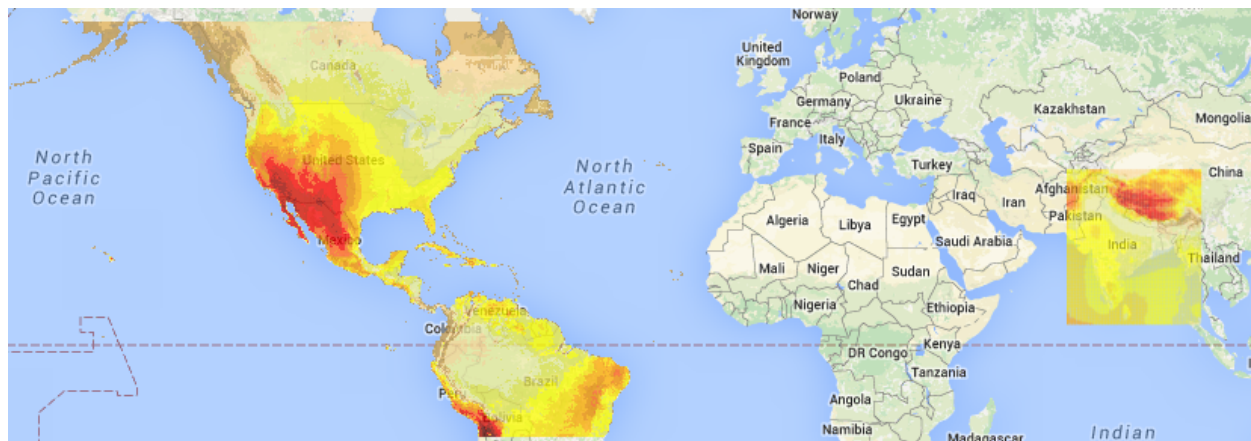
If the weather file contains albedo (ground reflectance) data, the average value of albedo values in the weather file. NaN indicates the file does not contain albedo data.

## ▼ About the NSRDB

The [NREL National Solar Radiation Database \(NSRDB\)](#) is an online database of weather files containing solar resource data in the [SAM CSV format](#). Files are available both as [typical-year](#) files and [single-year](#) files. The database covers the parts of the Americas and Asia shown in the map below. The current data is called PSM (Physical Solar Model) for the U.S., and SUNY for Asia. For details about the data see these pages on the NSRDB website:

- [U.S. data](#)
- [International data](#)

The NSRDB also contains legacy datasets for the U.S. from older versions of the NSRDB, including MTS3 (TMY3 1991-2010), MTS2 (TMY3 1991-2005), and MTS1 (TMY2 1961-1990). We recommend that you use the latest PSM data for your work in SAM, but the older data is available if you need it.



**Important Note for CSP Modelers!** SAM's CSP models assume that each DNI value in the weather file represents the average irradiance over the time step, and calculate sun angles for the midpoint of the time step. In weather files from the NSRDB, the irradiance data is measured instantaneously at either the beginning of the hour (TMY data), midpoint of the hour (single-year data), or beginning of the 30-minute time step (30-minute single-year data). As a result, if you use an NSRDB PSM weather file with a CSP model with either hourly TMY data or 30-minute single-year data, the sun angle for each time step will be for a different time than the time for the instantaneous irradiance values. See [Time Convention and Sun Position](#) for details.

**Notes.**

The NSRDB requires an email address to download weather file. When you download a weather file from SAM, SAM submits the email address that you used to [register SAM](#). NREL uses your email address to determine how many people are using the NSRDB. It does not share email addresses.

Different types of weather files in the NSRDB use different time conventions. See [Time Convention and Sun Position](#) for details.

When you download a file from the NSRDB website, SAM displays a "-" for the City, State, and Country fields because the NSRDB files do not contain that information. This will not affect simulation results. The location information SAM requires for simulations is latitude, longitude, elevation and time zone.

SAM uses the [Google Maps API Geocoding Service](#) service to identify the geographic coordinates (latitude and longitude) of a location when you type a street address or city and state name to identify the location.

For information about downloading weather files and data from other sources, see the [Weather Data](#) page on the SAM website.

SAM downloads weather files with the following hourly data from the NSRDB:

- Direct normal (beam) irradiance, DNI ( $W/m^2$ )
- Diffuse horizontal irradiance, DHI ( $W/m^2$ )
- Dry-bulb temperature ( $^{\circ}C$ )
- Dew-point temperature ( $^{\circ}C$ )
- Relative humidity (%), for single-year files only
- Atmospheric pressure (mbar)
- Wind speed at 2 meters above the ground (m/s)
- Wind direction ( $^{\circ}E$  of N)
- Albedo

**Note.** Weather files with snow depth data for the Detailed Photovoltaic model are not available from the NSRDB PSM dataset. They are available for 239 locations in the United States from the legacy [MTS1 \(TMY2\) files in the original format](#), which cover the period 1961 - 1990. See [Snow Losses](#) for details.

## 23.2 System Design

The System Design page shows inputs for design point parameters that determine the system's nameplate capacity. Use the System Design inputs to define the nominal ratings of the system, and then specify details for each part of the system on the appropriate input pages.

**Notes.** All of the system design inputs are nominal values, or values at the system's design point. SAM calculates actual values during simulation and reports them in the [results](#).

## Design Point Parameters

### Solar Field

#### Design-point DNI, $W/m^2$

The direct normal irradiance (DNI) available at the design point.

Increasing this value indicates that fewer heliostats are needed to achieve the reference condition power, while decreasing this value has the opposite effect. The design-point DNI value should represent the DNI at which your plant should achieve the specified thermal rating, including thermal and piping losses

For design-point calculations involving solar irradiance, SAM uses the design-point DNI value with the sun position at noon on the summer solstice (June 21 north of the equator, and December 21 south of the equator).

#### Target Solar multiple

The field aperture area expressed as a multiple of the aperture area required to meet the thermal load.

#### Target receiver thermal power, MWt

The thermal power required at the receiver outlet to meet the design thermal load.

$$\text{Receiver Thermal Power (MWt)} = \text{Solar Multiple} \times \text{Heat Sink Power (MWt)}$$

This set of inputs defines the design-point operating conditions of the steam in the solar field. The field inlet and outlet temperatures, the pressure constraints, and the boiler outlet quality (if applicable) are used to calculate the enthalpy of steam during the annual performance calculation at each collector module in the loop.

#### Field inlet temperature, °C

The estimated temperature of feedwater from the power cycle at the inlet of the solar field. This value is used to calculate estimated thermal losses from the solar field at design, and is not directly used in calculating the hourly performance for the annual simulation. The field inlet temperature is calculated during performance runs based on the power cycle conversion efficiency and the steam temperature at the inlet of the power cycle.

#### Field outlet temperature, °C

The estimated design-point steam outlet temperature from the solar field. The actual field outlet temperature is calculated in the performance runs based on the Loop flow configuration (once-through or recirculated boiler), the boiler outlet quality (for recirculated designs), collector performance, and flow rate constraints. The actual field outlet temperature during performance calculations is highly sensitive to the ratio of superheater to boiler aperture area, and consequently, the Field outlet temperature that you specify may differ substantially from the actual outlet temperature if care is not taken in selecting the correct number of superheater modules in the recirculated boiler design. Refer to the documentation on the number of boiler/superheater modules for more information.

#### Field outlet steam quality

The field outlet steam quality is used to calculate the mass flow rate of steam. This value represents the fraction of fluid exiting the solar field that is in vapor phase. The balance of the unevaporated fluid

recirculates to the inlet of the solar field and is mixed with the subcooled feedwater from the process heat application.

## Heat Sink

The heat sink parameters describe the process heat application's thermal load.

**Heat sink power (MWt)**

**Heat sink inlet pressure (bar)**

**Heat sink fractional pressure drop**

## System Availability

System availability losses are reductions in the system's output due to operational requirements such as maintenance down time or other situations that prevent the system from operating as designed.

**Note.** To model curtailment, or forced outages or reduction in power output required by the grid operator, use the inputs on the [Grid Limits](#) page.

To edit the system availability losses, click **Edit losses**.

The [Edit Losses](#) window allows you to define loss factors as follows:

- Constant loss is a single loss factor that applies to the system's entire output. You can use this to model an availability factor.
- Hourly losses apply to specific hours of the year.

SAM reduces the system's output in each hour by the loss percentage that you specify for that hour. For a given hour, a loss of zero would result in no adjustment. A loss of 5% would reduce the output by 5%, and a loss of -5% would increase the output value by 5%. For subhourly simulations, SAM applies the loss factor for a given hour to each time step in that hour

## 23.3 Solar Field

### System Design Point Parameters

These values are from the [System Design page](#) are for reference.

### Solar Field Design Point

#### Solar Field Parameters

##### Number of modules in boiler section

The number of boiler units in series in a single loop, each with geometry as defined on the Collector and Receiver page under the Linear Fresnel Boiler Geometry dropdown option.

**Solar elevation for collector nighttime stow, deg**

The solar elevation angle (above the horizon) that sets the operational limit of the collector field in the evening hours. When the solar elevation angle falls below this value, the collector field will cease operation.

**Solar elevation for collector morning deploy, deg**

The solar elevation angle (above the horizon) that sets the operational limit of the collector field in the morning hours. When the solar elevation angle rises above this value, the collector field will begin operation.

**Stow wind speed, m/s**

The maximum allowable wind velocity before the collectors defocus and enter safety stow position. The solar field cannot produce thermal energy during time steps in which the ambient wind velocity exceeds this limit.

**Collector azimuth angle (degrees)**

The azimuth angle of all collectors in the field, where zero degrees is pointing toward the equator, equivalent to a north-south axis. West is 90 degrees, and east is -90 degrees. SAM assumes that the collectors are oriented 90 degrees east of the azimuth angle in the morning and track the daily movement of the sun from east to west.

The collector azimuth angle variable is not active with the **Solar position table option** on the [Collector and Receiver page](#). The variable is only active with either the two incidence angle options for specifying the solar field.

**Design point ambient temperature, °C**

The reference ambient temperature for the solar field, used as a basis for calculating thermal losses from the receivers and piping. Note that this value is not used as a reference for receiver thermal losses if the evacuated tube receiver option is selected on the Collector and Receiver page.

**Tracking Power (W/m<sup>2</sup>)**

The electric power in Watts per area of collector aperture required by the tracking mechanism of each collector in the field during hours of operation.

**Piping thermal loss coefficient (W/K-m<sup>2</sup>-aper)**

Thermal loss per area of collector aperture.

**Steam Design Conditions****Cold header pressure drop fraction**

The fractional pressure drop across the cold header section of the solar field at design. The absolute pressure drop at design is equal to the fractional drop times the rated turbine inlet pressure.

**Boiler pressure drop fraction**

The fractional pressure drop across the boiler section of the solar field at design. The absolute pressure drop at design is equal to the fractional drop times the rated turbine inlet pressure.

**Average design point hot header pressure drop fraction**

The fractional pressure drop across the hot header section of the solar field at design. The absolute pressure drop at design is equal to the fractional drop times the rated turbine inlet pressure.

**Total solar field pressure drop**

The total calculated solar field pressure drop at design.

**Freeze protection temperature, °C**

The temperature below which auxiliary fossil backup heat is supplied to the solar field to prevent water from freezing in the equipment. You should set this value such that a reasonable margin exists between activation of the electric heat trace freeze protection equipment and the actual freezing point of water.

**Field pump efficiency**

The isentropic efficiency of the feedwater and recirculation pump (if applicable) in the solar field. The total work required to propel the feedwater is divided by this efficiency value to give the electrical parasitic pumping requirement.

**Mirror Washing**

SAM reports the water usage of the system in the results based on the mirror washing variables. The annual water usage is the product of the water usage per wash and 365 (days per year) divided by the washing frequency.

**Water usage per wash**

The volume of water in liters per square meter of solar field aperture area required for periodic mirror washing.

**Washing frequency**

The number of days between washing.

**Plant Heat Capacity****Thermal inertia per unit of solar field**

The amount of energy required to increase the working temperature of the solar field, per unit aperture area of the solar field. The thermal inertia term is used to model the startup and shutdown transient behavior of the solar field. During startup, the thermal energy produced by the solar field is reduced according to the energy that goes into heating the working fluid, receiver components, piping, fittings, and insulation. This input captures all of those aspects of transient startup in the solar field.

**Land Area**

The land area inputs determine the total land area in acres that you can use to estimate land-related costs in \$/acres on the [System Costs](#) page. The land area inputs are inputs to the financial model, not the performance model, so they do not affect the performance model energy calculations.

**Solar field area, acres**

The actual aperture area converted from square meters to acres:

$$\text{Solar Field Area (acres)} = \text{Actual Aperture (m}^2\text{)} \times \text{Row Spacing (m)} / \text{Maximum SCA Width (m)} \times 0.0002471 \text{ (acres/m}^2\text{)}$$

The maximum SCA width is the aperture width of SCA with the widest aperture in the field, as specified in the loop configuration and on the [Collectors \(SCA\)](#) page.

**Non-solar field land area multiplier**

Land area required for the system excluding the solar field land area, expressed as a fraction of the



solar field aperture area. A value of one would result in a total land area equal to the total aperture area.

**Total land area, acres**

Land area required for the entire system including the solar field land area

$$\text{Total Land Area (acres)} = \text{Solar Field Area (acres)} \times (1 + \text{Non-Solar Field Land Area Multiplier})$$

The land area appears on the System Costs page, where you can specify land costs in dollars per acre.

## 23.4 Collector and Receiver

### Collector Geometry and Optical Performance

**Reflective aperture area, m<sup>2</sup>**

The total reflective aperture area for the module. This value is multiplied by the collector optical efficiency and the solar irradiance value to determine the total thermal energy incident on the module's receiver.

**Length of collector module, m**

The length of a collector module along the receiver axis. This value is used to calculate thermal losses that are expressed in units of W/m.

**Tracking error**

A fixed optical loss representing collector tracking error. This value multiplies the other fixed optical losses and the time-varying collector optical efficiency to determine the total optical efficiency.

**Geometry effects**

A fixed optical loss representing collector geometry effects. This value multiplies the other fixed optical losses and the time-varying collector optical efficiency to determine the total optical efficiency.

**Mirror reflectivity**

The optical loss fraction associated with mirror reflectivity, excluding soiling. This value multiplies the other fixed optical losses and the time-varying collector optical efficiency to determine the total optical efficiency.

**Mirror soiling**

The optical loss fraction associated with soiling on the mirrors. This value multiplies the other fixed optical losses and the time-varying collector optical efficiency to determine the total optical efficiency.

**General optical error**

Other optical loss not captured in the time-varying collector optical efficiency table/polynomials and fixed derates. This value multiplies the other fixed optical losses and the time-varying collector optical efficiency to determine the total optical efficiency.

### Optical characterization method

You can select one of three options for characterizing the optical performance of the solar field in addition to the fixed optical losses specified in the Collector Geometry and Optical Performance section. The three methods determine how the optical efficiency varies with sun position.

The optical efficiency is defined as follows:

$$\text{Optical Efficiency} = \frac{\text{Total Thermal Energy Absorbed by Receiver}}{(\text{Direct Normal Irradiance} \times \text{Actual Aperture Area})}$$

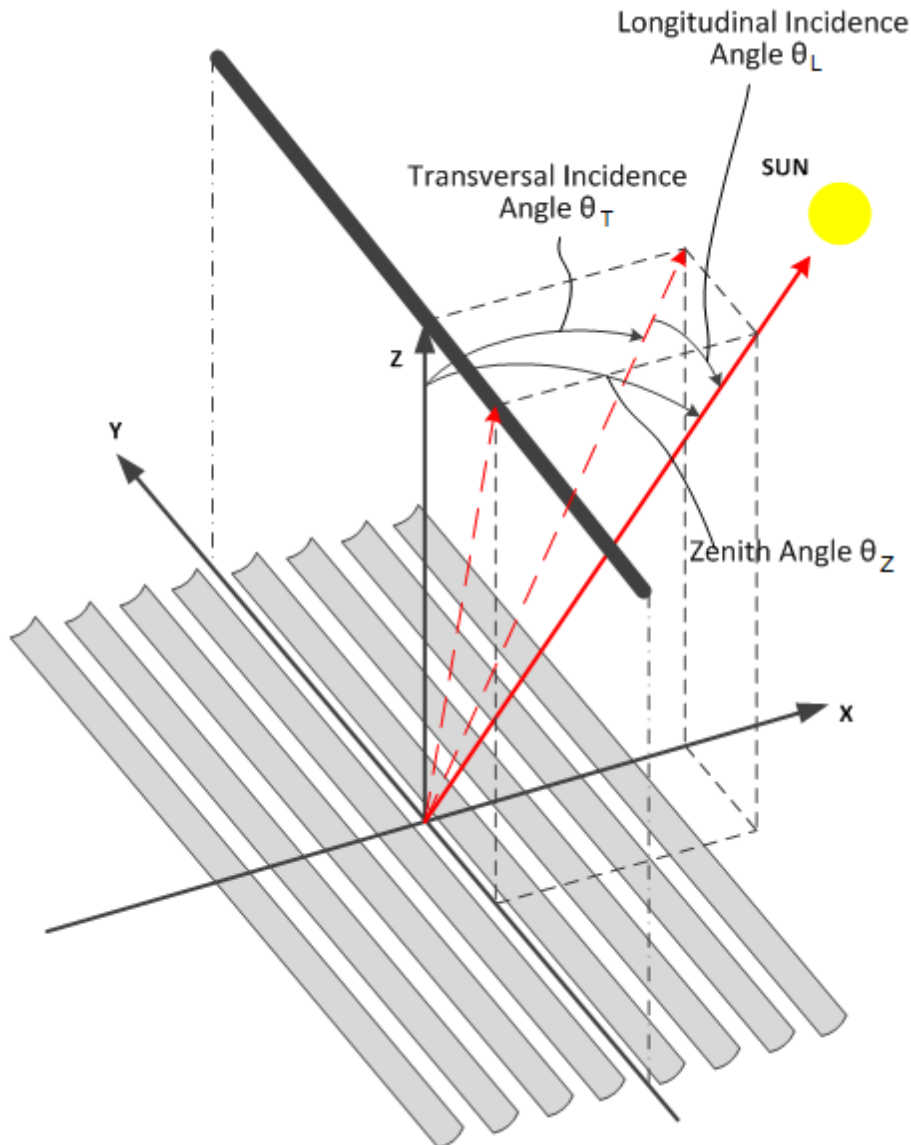
### Solar position table

The solar position table option allows you to specify optical efficiency of the solar field as a function of solar azimuth and zenith angles. SAM uses a solar azimuth angle convention where true North is equal to  $-180/+180^\circ$  and South equals  $0^\circ$ . The solar zenith angle is zero when the sun is directly overhead and  $90^\circ$  when the sun is at the horizon.

The solar position may contain any number of rows and columns, but should contain enough information to fully define the performance of the solar field at all sun positions for which the field will operate. The table must contain more than one row and column.

### Collector incidence angle table

The collector incidence angle table option allows you to specify solar field optical efficiency as a function of the longitudinal and transversal solar incidence angles. The collector incidence angles are defined as shown in the following figure, where the transversal incidence angle is given as  $\phi_T$  and the longitudinal incidence angle is  $\phi_L$ . The solar zenith angle is  $\theta_z$ .



### Incidence angle modifiers

The incidence angle modifier option allows you to specify optical performance of the solar field collectors using polynomial equations (up to fourth order) in both the transversal and longitudinal incidence angle directions. Refer to the Collector incidence angle table input documentation (above) for descriptions of the transversal ( $\phi_T$ ) and longitudinal ( $\phi_L$ ) collector angles.

### Solar Position/Collector Incidence Angle Table

#### Import

Import a table from a text or data file. The file can contain values separated by comma, space, or tab characters, but must be formatted according to the following rules:

- The first row in the file specifies the angles for the solar azimuth (for the Solar position table) or collector transversal incidence (for the Collector incidence angle table). The first entry of this row should be blank.
- Each additional row specifies optical efficiency for a specific zenith angle (for the Solar position table) or longitudinal incidence angle (for the Collector incidence angle table). The first entry of the row must be the zenith or longitudinal incidence angle corresponding to the optical efficiency entries in that row.
- The rows of the table should be sorted according to zenith/longitudinal incidence angle from lowest to highest.

An example tab-delimited table is as follows, where numbers in bold correspond to the solar zenith (row headers) and azimuth (column headers) angles:

	<b>-180</b>	<b>90</b>	<b>0</b>	<b>90</b>	<b>180</b>
<b>0</b>	1.0	1.0	1.0	1.0	1.0
<b>30</b>	0.95	0.98	0.99	0.98	0.95
<b>60</b>	0.60	0.70	0.75	0.70	0.60
<b>90</b>	0.0	0.0	0.0	0.0	0.0

Note that SAM automatically sizes the table on the Collector and Receiver page to match the size of the array that is being imported.

### Export

Export the optical efficiency table on the Collector and Receiver page to a text file.

### Copy

Copy the optical efficiency table on the Collector and Receiver page to the clipboard for transfer to an optical efficiency table in another case or to other text applications.

### Paste

Paste an optical efficiency table from another SAM case or from a text file into the active case.

### Rows

Specify the number of desired rows in the table.

### Cols

Specify the number of desired columns in the table.

## Incidence Angle Modifier Coefficients

This option allows you to specify the optical performance of the collector field as functions of the transversal and longitudinal incidence angles where the performance is expressed in polynomial form.

### Transverse incidence angle modifier

The incidence angle modifier polynomial for the transversal incidence angle, as defined in the documentation for the collector incidence angle table (above). The polynomial to calculate the optical efficiency reduction associated with deviation of the irradiation incidence angle in the transversal plane is as follows:

$$IAM_T = C_0 + C_1 \cdot \phi_T + C_2 \cdot \phi_T^2 + C_3 \cdot \phi_T^3 + C_4 \cdot \phi_T^4$$

where  $\phi_T$  is the transversal incidence angle.

**Longitudinal incidence angle modifier**

The incidence angle modifier polynomial for the longitudinal incidence angle, as defined in the documentation for the collector incidence angle table (above). The polynomial to calculate the optical efficiency reduction associated with deviation of the irradiation incidence angle in the longitudinal plane is as follows:

$$IAM_L = C_0 + C_1 \cdot \phi_L + C_2 \cdot \phi_L^2 + C_3 \cdot \phi_L^3 + C_4 \cdot \phi_L^4$$

where  $\phi_L$  is the longitudinal incidence angle.

**Receiver Geometry and Heat Loss****Polynomial heat loss model/Evacuated tube model**

You can specify the thermal losses from the solar field receiver components using one of two approaches: the first approach allows general specification of thermal losses using polynomial equations. The polynomials provide heat loss as a function of steam temperature with a correction based on wind velocity, and heat loss is evaluated at each collector module in the loop. The second option allows the use of a detailed evacuated tube receiver model. Select the model using the dropdown menu in this section.

**Polynomial fit heat loss model****Steam temperature adjustment**

This polynomial gives thermal losses in the solar field receiver component as a function of the difference between steam temperature and ambient dry-bulb temperature in degrees Celsius. Thermal losses are evaluated at each collector module in the loop using the following expression for the coefficient of heat loss [W/m]:

$$F_{hl}(T) = C_0 + C_1 \cdot \Delta T_{local} + C_2 \cdot \Delta T_{local}^2 + C_3 \cdot \Delta T_{local}^3 + C_4 \cdot \Delta T_{local}^4$$

where  $\Delta T_{local}$  is the local (to the module) difference between the steam temperature and ambient dry bulb temperature.

**Wind velocity adjustment**

SAM allows you to adjust the thermal loss coefficient calculated from the Steam temperature adjustment polynomial ( $F_{hl}(T)$ ). The resulting value from the wind velocity polynomial multiplies the steam temperature heat loss polynomial, as follows:

$$F_{hl}(V_{wind}) = C_0 + C_1 \cdot V_{wind} + C_2 \cdot V_{wind}^2 + C_3 \cdot V_{wind}^3 + C_4 \cdot V_{wind}^4$$

$$F_{hl,total} = F_{hl}(T) \cdot F_{hl}(V_{wind})$$

**Evacuated tube heat loss model****Absorber tube inner diameter (m)**

Inner diameter of the receiver absorber tube, this surface in direct contact with the heat transfer fluid.

**Absorber tube outer diameter (m)**

Outer diameter of the receiver absorber tube, the surface exposed to the annular vacuum.

**Glass envelope inner diameter (m)**

Inner diameter of the receiver glass envelope tube, the surface exposed to the annular vacuum.

**Glass envelope outer diameter (m)**

Outer diameter of the receiver glass envelope tube, the surface exposed to ambient air.

**Absorber flow plug diameter (m)**

A non-zero value represents the diameter of an optional plug running axially and concentrically within the receiver absorber tube. A zero value represents a receiver with no plug. The plug allows for an increase in the receiver absorber diameter while maintaining the optimal heat transfer within the tube heat transfer fluid. For a non-zero value, be sure to use annular flow for the absorber flow pattern option.

**Internal surface roughness**

The surface roughness of the inner receiver pipe surface exposed to the heat transfer fluid, used to determine flow shear force and the corresponding pressure drop across the receiver.

Surface roughness is important in determining the scale of the pressure drop throughout the system. As a general rule, the rougher the surface, the higher the pressure drop (and parasitic pumping power load). The surface roughness is a function of the material and manufacturing method used for the piping. A conservative roughness value for extruded steel pipe (the type often used for the absorber pipe) is about  $3\text{e-}6$  meters. The default value of  $4.5\text{e-}5$  m is based on this value and the absorber tube inner diameter value of 0.066 m:  $3\text{e-}6 \text{ m} / 6.6\text{e-}2 \text{ m} = 4.5\text{e-}5$ .

**Absorber flow pattern (m)**

Use standard tube flow when the absorber flow plug diameter is zero. Use annular flow with a non-zero absorber flow plug diameter.

**Absorber material type**

The material used for the absorber tube. Choose from stainless steel or copper.

**Variant weighting fraction**

The fraction of the solar field that consists of the active receiver variation. For each receiver type, the sum of the four variations should equal one. You can use the receiver variations to model a solar field with receivers in different conditions. If you want all of the receivers in the field to be identical, then you can use a single variation and assign it a variant weighting fraction of 1.

When you use more than one receiver variation, be sure that the sum of the four variant weighting fractions is 1.

Here's an example of an application of the receiver variations for a field that consists of a two receiver types. The first type, Type 1, represents receivers originally installed in the field. Type 2 represents replacement receivers installed as a fraction of the original receivers are damaged over time.

Over the life of the project, on average, 5 percent of the Type 1 receivers have broken glass envelopes, and another 5 percent have lost vacuum in the annulus. We'll also assume that degraded receivers are randomly distributed throughout the field -- SAM does not have a mechanism for specifying specific locations of different variations of a given receiver type. To specify this situation, we would start with Type 1, and use Variation 1 to represent the 90 percent of intact receivers, assigning it a variant weighting fraction of 0.90. We'll use Variation 2 for the 5 percent of receivers with broken glass envelopes, giving it a weighting fraction of 0.05, and Variation 3 for the other 5 percent of lost-vacuum receivers with a weighting fraction of 0.05. We'll assign appropriate values to the parameters for each of the two damaged receiver variations.

Next, we'll specify Type 2 to represent intact replacement receivers. We will use a single variation for the intact Type 2 receivers.

On the Solar Field page, we'll specify the single loop configuration (assuming a loop with eight assemblies), using Type 2 for the first and second assembly in the loop, and Type 1 receivers (with the variant weighting we assigned on the Receivers page) for the remaining six assemblies in the loop

**Absorber absorptance**

The ratio of radiation absorbed by the absorber to the radiation incident on the absorber.

**Absorber emittance**

The energy radiated by the absorber surface as a function of the absorber's temperature. You can either specify a table of emittance and temperature values, or specify a single value that applies at all temperatures.

**Envelope absorptance**

The ratio of radiation absorbed by the envelope to the radiation incident on the envelope, or radiation that is neither transmitted through nor reflected from the envelope. Used to calculate the glass temperature. (Does not affect the amount of radiation that reaches the absorber tube.)

**Envelope emittance**

The energy radiated by the envelope surface.

**Envelope transmittance**

The ratio of the radiation transmitted through the glass envelope to the radiation incident on the envelope, or radiation that is neither reflected nor refracted away from the absorber tube.

**Broken glass**

Option to specify that the envelope glass has been broken or removed, indicating that the absorber tube is directly exposed to the ambient air.

**Annulus gas type**

Gas type present in the annulus vacuum. Choose from Hydrogen, air, or Argon.

**Annulus pressure (torr)**

Absolute pressure of the gas in the annulus vacuum, in torr, where 1 torr = 133.32 Pa

**Estimated avg. heat loss (W/m)**

An estimated value representing the total heat loss from the receiver under design conditions. SAM uses the value to calculate the total loop conversion efficiency and required solar field aperture area for the design point values on the [Solar Field page](#). It does not use the value in simulation calculations.

**Bellows shadowing**

An optical derate factor accounting for the fraction of radiation lost after striking the mechanical bellows at the ends of the receiver tubes.

**Dirt on receiver**

An optical derate factor accounting for the fraction of radiation lost due to dirt and soiling on the receiver.

**Aggregate Weighted Losses****Average field temp difference at design**

The effective temperature for thermal loss estimates, equal to the average solar field temperature. This temperature is used to evaluate thermal losses from the solar field receivers (polynomial heat loss model only) and from piping as specified on the Parasitics page. This value is calculated as the average of the Field inlet temperature and Field outlet temperature on the Solar Field page.

**Heat loss at design**

Calculated estimate of thermal losses at the Average field temp difference at design. In the case of the polynomial heat loss model, the estimate is calculated based on the difference between the average temperature and the design-point ambient temperature from the Solar Field page. In the case of the evacuated tube receiver model, the estimate is based on the user-specified Estimated avg. heat loss values on the Collector and Receiver page.

**Receiver thermal derate**

Calculated value indicating the estimated thermal efficiency of the solar field receivers. This value is calculated based on the Heat loss at design calculated value, and is used only to size the solar field aperture area. Note that this value is not used in annual hourly performance calculations.

**Receiver optical derate**

The reduction in optical efficiency associated with envelope transmittance and receiver soiling. This derate is calculated as a weighted sum for the four receiver variants and only applies to the evacuated receiver model option.

**Collector optical loss at normal incidence**

The optical efficiency from the optical table or incident angle modifier polynomials at normal solar incidence.

## 24 Lifetime and Degradation

The Lifetime and Degradation inputs allow you to model a decline in the system's output over time due, for example, to aging of equipment.

SAM models annual degradation differently for the different performance models:

- AC degradation with single year simulation for all models except detailed photovoltaic, PV battery, generic battery, fuel cell, and geothermal models.
- DC degradation with simulation over analysis period for the detailed photovoltaic, PV battery, and fuel cell model, where degradation applies to the DC output of the array. Lifetime simulations allow for modeling the effect of PV module degradation on inverter power limiting losses over time, and for battery replacements where applicable.
- AC degradation with simulation over analysis period for the generic battery model, where the system generates AC power. Lifetime simulations allow for modeling battery replacements.
- The geothermal model calculates the electricity generated by the system in each month over its lifetime rather than hourly or subhourly over a single year. The degradation rate is not available for geothermal systems because the model calculates the system's electrical output from year to year.

**Note.** The multi-year simulation uses the same weather file for each year, so it does not accurately represent the effect of changes in the solar resource and weather from year to year over the analysis period.



The Detailed Photovoltaic and PV Battery models have an additional set of inputs for [lifetime daily losses](#) that can be used to model losses in the system that vary over the analysis period and are not covered by annual degradation.

## Annual Degradation

### AC Degradation for Single-year Simulation

SAM runs a simulation over one year, and applies the degradation rate to the system's total annual AC output in Years 2 and later. A degradation rate of 0 means that the system's annual output is constant over the project life, a degradation rate of 0.5% would mean that the system's annual output in each year decreases by 0.5% from the previous year's output. A degradation rate of -0.5% would mean that the system's output increases each year. This is the degradation option for the following configurations:

- PVWatts
- PVWatts Battery
- Concentrating Solar Power (CSP)
- Wind
- Solar Water Heating
- Biomass Combustion
- Generic System

#### Annual AC degradation rate

The annual reduction in the system's AC output as a percentage of the system's total annual AC output.

For the solar water heating model, the system output is the

### DC Degradation for Multi-year Simulation

The DC degradation rate applies to the photovoltaic array's DC output in each time step over the analysis period defined on the Financial Parameters page. This is the degradation option for:

- Detailed Photovoltaic
- PV Battery
- Fuel Cell PV Battery

#### Annual DC degradation rate

The reduction in system DC output in each time step as a percentage of the system's DC output in each time step by year.

### AC Degradation with Simulation over Analysis Period

The AC degradation rate applies to the system's AC output in each time step over the analysis period defined on the Financial Parameters page. This is the degradation option for:

- Generic Battery

#### Annual AC Degradation rate

The reduction in system AC output in each time step as a percentage of the system's AC output in each time step by year.

## Lifetime Daily Losses

For the Detailed Photovoltaic and PV Battery models, in addition to the annual DC degradation, you can define tables of daily AC and DC losses over the analysis period. This requires that you have a set of losses for each day over the analysis period (defined on the Financial Parameters page). For example, for an analysis period of 25 years, you would need a table of  $1 \text{ value/day} \times 365 \text{ days/year} \times 25 \text{ years} = 9,125 \text{ values}$ .

**Note.** Inputs on the [Grid Limits](#) and [Losses](#) page can be used to model curtailment and system availability losses.

### Enable lifetime daily DC losses

Check the box, and then click **Edit time series data** to [enter a table of DC loss percentages](#) as a percentage of the system's DC output in each day for each year in the analysis period. The table requires a set of 365 values for each year in the analysis period.

### Enable lifetime daily AC losses

Check the box, and then click **Edit time series data** to [enter a table of AC loss percentages](#) as a percentage of the system's AC output in each day for each year in the analysis period. The table requires a set of 365 values for each year in the analysis period.

## Value and Schedule Mode

### Value Mode: Fixed Degradation Rate

For most situations where you want to model an annual reduction in the system's output, you can use a single annual degradation rate that applies to all years of the project cash flow. SAM applies the percentage to the system's total annual electrical output value in years 2 and later.

For example, a degradation rate of 1% for a system with a net annual output of 100,000 kWh in Year one results in annual output values of 100,000 kWh in year 1, 99,000 kWh in year 2, 98,010 kWh in year 3, 97,029.9 kWh in year 4, etc.

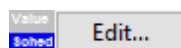
### Schedule Mode: Annual Degradation Rates

In some situations, you may want to assign a different degradation rate to different years of the project cash flow. To do that, you use the annual schedule option to specify a table of degradation rate values. In Schedule mode, SAM applies the degradation rate for a given year to the annual output in Year one to calculate the annual output for that year.

For example, for a system with a Year 1 output of 10,000 kWh, if you specify a degradation rate of 0.5% for Year 5, SAM would calculate the annual output in Year 5 as follows:  $10,000 \text{ kWh} \times (1 - 0.005) = 9,950 \text{ kWh}$ .

### To enter an annual schedule of degradation rates:

1. Click the grey and blue Value/Sched button so **Sched** is highlighted in blue. SAM replaces the variable's value with an Edit button.



2. Click **Edit**.
3. Change **Number of values** to the the analysis period from the Financial Parameters page. The

number of rows in the table should be the number of years in the analysis period.

4. In the table of values, either type a value in each row, or click Paste to paste values from your computer's clipboard. Row 1 is for Year 1.

To delete a value, select it and press the Delete key on your keyboard.

You must type a value for each year. If you delete a value, SAM will clear the cell, and you must type a number in the cell or SAM will consider the schedule to be invalid. Type a zero for years with no value.

## Memory Saving Option for Subhourly Simulations

For the Detailed Photovoltaic and PV Battery performance models, if you are running subhourly simulations over the analysis period, the number of values for each output variable can be very large. For, example, one-minute simulations over a 25-year analysis period would result in  $1 \text{ time step/min} \times 60 \text{ min/hr} \times 8,760 \text{ hr/yr} \times 25 \text{ yr} = 13,140,000$  time steps, so each output variable would store over 13 million values.

If your computer is experiencing memory problems, or if the tables and graphs on the Results page are not working properly, you can clear **Save all output variables over analysis period** to reduce the amount of memory required to display simulation results. That will cause SAM to save only a selection of variables in "lifetime mode" with values over the entire analysis period. The remaining variables will only store one year's worth of data so you can still examine hourly data to see how the system performs.

# 25 Grid Limits

The Grid Limits page provides inputs for setting a grid power export limit, and for curtailing the system's exports to the grid.

SAM uses the interconnection limit and curtailment inputs to adjust the value calculated for the system AC power output in each hourly or subhourly time step by applying an adjustment factor to the AC power output value. This assumes that the actual system has a mechanism for adjusting the power output to meet these grid limits. For example a photovoltaic system might adjust its power output using power electronics to adjust DC operating voltages, or a wind system might feather the turbine blades. You should be sure to account for any costs associated with designing the system to adjust its power output on the System Costs page.

## Grid Interconnection Limit

The grid interconnection limit is the maximum AC power that the system can deliver to the grid. SAM considers any power above the limit to be curtailed power.

### Enable interconnection limit

Check this box if there is a limit to the amount of power the system is allowed to deliver to the grid.

### Grid interconnection limit, kWac

The maximum power the system is allowed to deliver to the grid in AC kilowatts. For time steps that the system AC power output exceeds the limit, the

## Grid Curtailment

Grid curtailment is a reduction in the amount of power the system is allowed to deliver to the grid. SAM models curtailment as a maximum system AC power output in each time step.

For the Single Owner and Merchant Plant financial models, curtailed power is compensated at the curtailment compensation rate on the [Revenue](#) page.

### Curtailment

A table of system AC power output values values for each simulation time step over one year.

Click **Edit array** to provide a table of power values. The number of rows in the table should match the number of records in the weather file.

For a weather file with hourly data, the time step is 60 minutes and the table should have 8,760 values. If you are using subhourly weather data, click **Change time step**, and enter the weather file time step in minutes.

- To paste data from a spreadsheet or other program, select the data in the spreadsheet with no header and copy it to your computer's clipboard. Then, in SAM click **Paste** in the Edit Array window.
- To import data from a text file, prepare a file with one column of data and one header row. SAM ignores the first row in the file and imports data in the remaining rows. Click **Import** in the Edit Array window and navigate to the file.

## 26 Financial Parameters

The Financial Parameters page is where you specify assumptions describing the project's financial and debt structure, tax rates, and other analysis parameters. SAM displays a different set of inputs depending on the financial model.

The screenshot shows the SAM 2015.6.30 interface. The top navigation bar includes a menu icon, a '+ New' button, and dropdown menus for 'residential' and 'third party ownership'. The left sidebar lists several categories: 'PVWatts, Third Party', 'Location and Resource', 'System Design', 'Lifetime', 'Financial Parameters' (which is highlighted with a mouse cursor), 'Electricity Rates', and 'Electric Load'. The main content area is divided into two sections: 'Terms of Agreement' and 'Analysis Parameters'. The 'Terms of Agreement' section has a radio button selected for 'Lease agreement', followed by input fields for 'First year monthly lease price' and 'Lease price escalation rate'. The 'Analysis Parameters' section has input fields for 'Agreement period' and 'Inflation rate'.

The inputs on the Financial Parameters page are different for the different financial models:

- [Residential](#)
- [Commercial](#)
- [Third Party Ownership - Host](#)
- [Third Party Ownership - Host / Developer](#)
- [Single Owner](#)
- [Merchant Plant](#)
- [Leveraged Partnership Flip](#)
- [All Equity Partnership Flip](#)
- [Sale Leaseback](#)
- [LCOE Calculator](#)

## 26.1 Residential

This topic describes the inputs on the Financial Parameters page for the Residential financial model. For a general description of financial structures SAM can model, see [Financial Models](#).

SAM displays results of the financial model in the [cash flow](#). See [Cash Flow Variables](#) for details.

### Loan Type

#### Standard Loan

For the standard loan option, loan interest payments are not tax deductible.

#### Mortgage

For the mortgage option, loan interest payments are tax deductible.

## Residential Loan Parameters

**Note.** For the residential mortgage and commercial financial models, SAM deducts loan interest payments from state and federal income taxes. For the residential loan option, SAM does not deduct loan interest payments. For details see, the project [cash flow](#) on the [Results](#) page.

### Debt Fraction

Percentage of the [net capital cost](#) to be borrowed.

For residential and commercial systems, the capital cost is the total installed cost from the System Costs page less any direct cash incentives on the [Incentives](#) page.

### Loan Term

Number of years required to repay a loan. Note that this value is different than the analysis period.

### Loan Rate

The annual nominal interest rate for the loan.

### Principal Amount

The loan principal amount, or amount borrowed.

This is a calculated value that you cannot directly edit. To change the value, change either the value of the debt fraction or a cost on the System Costs page.

$$\text{Principal Amount (\$)} = \text{Total Installed Cost (\$)} \times \text{Debt Fraction (\%)}$$

Where *Total Installed Cost* is from the [System Costs](#) page.

### WACC

SAM displays the WACC for projects with debt when you specify the debt size as a debt percent. It is shown for reference and not used in any calculations.

This is a calculated value that you cannot directly edit. To change its value, change one of the parameters in the following equations:

$$\text{WACC} = [ \text{Nominal Discount Rate} \div 100 \times (1 - \text{Debt Percent} \div 100) + \text{Debt Percent} \div 100 \times \text{Loan Rate} \div 100 \times (1 - \text{Effective Tax Rate} \div 100) ] \times 100$$

See the **Nominal discount rate** variable description for its equation. The effective tax rate is a single number that includes both the federal income tax rate and state income tax rate. SAM uses the effective tax rate for several calculations requiring a total income tax value:

$$\text{Effective Tax Rate} = [ \text{Federal Tax Rate} \div 100 \times (1 - \text{State Tax Rate} \div 100) + \text{State Tax Rate} \div 100 ] \times 100$$

## Analysis Parameters

The analysis parameters specify the analysis period, inflation rate and discount rate.

### Analysis Period

Number of years covered by the analysis. Typically equivalent to the project or investment life. The analysis period determines the number of years in the project [cash flow](#).

### Inflation Rate

Annual rate of change of costs, typically based on a price index, expressed as a percentage. SAM

uses the inflation rate to calculate the value of costs in years two and later of the project cash flow based on Year One dollar values that you specify on the [System Costs](#) page, Financial Parameters page, [Electricity Rates](#) page, and [Incentives](#) page.

The default value of 2.5% is based on [consumer price index data from the U.S. Department of Labor Bureau of Labor Statistics](#), and is the average of the annual average consumer price index between 1991 and 2012.

The inflation rate may be either a positive or negative value.

### Real Discount Rate

A measure of the time value of money expressed as an annual percentage. SAM uses the real discount rate to calculate the present value (value in year one) of dollar amounts in the project cash flow over the analysis period and to calculate annualized costs.

SAM's financial model results are very sensitive to the real discount rate input. If you plan to use metrics like the net present value (NPV), levelized cost and PPA price, and internal rate of return, you should carefully consider the discount rate to use for your analysis. The default value is based on a reasonable guess for renewable energy projects in the United States. Because discount rates are very subjective and project developers are typically reluctant to share information about discount rates, published documents on renewable energy finance typically do not include detailed information about discount rates.

**Note.** For projects with one of the PPA financial models, SAM includes both a discount rate and internal rate of return (IRR) in the analysis. For these projects, the discount rate represents the value of an alternative investment, and the IRR can represent a profit requirement or the risk associated with the project. For example, the IRR may be higher than the discount rate for a renewable energy project with higher risk than an alternative investment.

### Nominal Discount Rate

SAM calculates the nominal discount based on the values of the real discount rate and the inflation rate:

$$\text{Nominal Discount Rate} = [ ( 1 + \text{Real Discount Rate} \div 100 ) \times ( 1 + \text{Inflation Rate} \div 100 ) - 1 ] \times 100$$

## Tax and Insurance Rates

### Federal and State Income Tax Rates

The annual federal and state income tax rate applies to taxable income and is used to calculate the project's tax benefits and liabilities.

You can specify either a single annual tax rate, or use the [Edit Schedule](#) window to specify a tax rate for each year. The latter option is useful for modeling a tax holiday where the tax rate for the first few years is zero.

For all projects, taxable income includes income from any incentives marked on the [Incentives](#) page as taxable.

For residential and commercial projects, SAM does not consider the value of electricity saved by the system to be taxable income. For commercial projects, because those savings represent the value of electricity purchases that would have been a tax-deductible operating expense to the commercial entity, SAM does reduce the project cash flow by the amount of federal and state income tax on the value of the electricity. In other words, with the renewable energy system in place, the commercial entity must pay tax on that portion of its income that it would have deducted as an operating expense.

For PPA projects, taxable income includes earnings before interest, taxes, depreciation and amortization (EBIDTA) and interest earned on reserve accounts. EBIDTA is revenue from electricity sales revenue (PPA revenue) less annual operation and maintenance, property tax, and insurance expenses.

### Sales Tax

The sales tax is a one-time tax that SAM includes in the project's total installed cost. SAM calculates the sales tax amount by multiplying the sales tax rate on the Financial Parameters page by the rate you specify under Indirect Capital Costs and the Total Direct Cost on the [System Costs](#) page.

For tax purposes, because SAM includes the sales tax amount in the total installed cost, it treats sales tax as part of the cost of property. For projects with depreciation (Commercial and PPA financial models only), SAM includes the sales tax amount in the depreciable basis. See IRS Publication 551, Basis of Assets, for more details.

Some states and other jurisdictions offer a sales tax exemption for renewable energy projects. To model a sales tax exemption in SAM, reduce the sales tax percentage as appropriate. For example, for a 100% sales tax exemption, enter a sales tax rate of zero.

For projects with debt, because SAM includes the sales tax amount in the total installed cost, the sales tax influences the debt amount and debt interest payment. For projects where debt interest payments are deductible from federal and state income tax (all financial models except Residential with standard loan), SAM includes sales tax in the calculation of the deductions.

### Insurance Rate (Annual)

SAM treats annual insurance payments as part of the annual operating costs. The insurance cost in year one of the project cash flow is the insurance rate multiplied by the total installed cost from the [System Costs](#) page. The first year cost is then increased by inflation in each subsequent year. For commercial and PPA projects, the insurance cost is a tax-deductible operating expense.

### Property Tax

Property tax is an annual project expense that SAM includes under Operating Expenses in the [cash flow](#).

SAM treats property tax as a tax-deductible operating expense for each year. In each year of the project cash flow, the property tax cost is the property tax rate multiplied by the assessed value for that year.

SAM determines the annual property tax payment by calculating an assessed value for each year in the cash flow, and applying the assessed percent to that value. The assessed value may decline from year to year at the rate you specify. The assessed percent and tax rate both remain constant from year to year.

For residential projects, the property tax amount is the only operating cost that can be deducted from state and federal income tax.

#### Assessed Percent

The assessed value of property subject to property taxes as a percentage of the system total installed cost specified on the [System Costs](#) page. SAM uses this value to calculate the assessed property value in year one of the project cash flow.

#### Assessed Value

The assessed property value in Year One of the project cash flow:

$$\text{Assessed Value (\$)} = \text{Assessed Percent (\%)} \times \text{Total Installed Cost (\$)}$$

Where Total Installed Cost is from the [System Costs](#) page.



### Assessed Value Decline

The annual decline in the assessed property value. SAM uses this value to calculate the property assessed value in years two and later of the project cash flow. For an assessed value that does not decrease annually, specify a value of zero percent per year.

### Property Tax

The annual property tax rate applies to the assessed value of the project in each year of the project cash flow.

## Salvage Value

SAM considers the salvage value to be project income in the final year of the project cash flow, and calculates the value as a percentage of the total installed cost from the [System Costs](#) page.

For example, if you specify a 10% salvage value for a project with a 30-year analysis period, and total installed cost of \$1 million, SAM includes income in Year 30 of  $\$100,000 = \$1,000,000 \times 0.10$ .

For residential projects, the salvage value has no effect on federal and state income tax.

For commercial and PPA projects, the salvage value is treated as a source of pre-tax revenue in the final year of the analysis period, increasing the federal and state taxable income.

### Net Salvage Value

The salvage value as a percentage of the project's total installed cost from the [System Costs](#) page.

### End of Analysis Period Salvage Value

The salvage value dollar amount that will appear in final year of the project [cash flow](#).

$$\text{End of Analysis Period Salvage Value (\$)} = \text{Net Salvage Value (\%)} \times \text{Total Installed Cost (\$)}$$

Where *Total Installed Cost* is from the [System Costs](#) page.

## 26.2 Commercial

This topic describes the inputs on the Financial Parameters page for the Commercial financial model. For a general description of financial structures SAM can model, see [Financial Models](#).

SAM displays results of the financial model in the [cash flow](#). See [Cash Flow Variables](#) for details.

### Commercial Loan Parameters

**Note.** For the residential mortgage and commercial financial models, SAM deducts loan interest payments from state and federal income taxes. For the residential loan option, SAM does not deduct loan interest payments. For details see, the project [cash flow](#) on the [Results](#) page.

### Debt Fraction

Percentage of the [net capital cost](#) to be borrowed.

For residential and commercial systems, the capital cost is the total installed cost from the System Costs page less any direct cash incentives on the [Incentives](#) page.

### Loan Term

Number of years required to repay a loan. Note that this value is different than the analysis period.

### Loan Rate

The annual nominal interest rate for the loan.

### Principal Amount

The loan principal amount, or amount borrowed.

This is a calculated value that you cannot directly edit. To change the value, change either the value of the debt fraction or a cost on the System Costs page.

$$\text{Principal Amount (\$)} = \text{Total Installed Cost (\$)} \times \text{Debt Fraction (\%)}$$

Where *Total Installed Cost* is from the [System Costs](#) page.

### WACC

SAM displays the WACC for projects with debt when you specify the debt size as a debt percent. It is shown for reference and not used in any calculations.

This is a calculated value that you cannot directly edit. To change its value, change one of the parameters in the following equations:

$$\text{WACC} = [ \text{Nominal Discount Rate} \div 100 \times (1 - \text{Debt Percent} \div 100) + \text{Debt Percent} \div 100 \times \text{Loan Rate} \div 100 \times (1 - \text{Effective Tax Rate} \div 100) ] \times 100$$

See the **Nominal discount rate** variable description for its equation. The effective tax rate is a single number that includes both the federal income tax rate and state income tax rate. SAM uses the effective tax rate for several calculations requiring a total income tax value:

$$\text{Effective Tax Rate} = [ \text{Federal Tax Rate} \div 100 \times (1 - \text{State Tax Rate} \div 100) + \text{State Tax Rate} \div 100 ] \times 100$$

## Analysis Parameters

The analysis parameters specify the analysis period, inflation rate and discount rate.

### Analysis Period

Number of years covered by the analysis. Typically equivalent to the project or investment life. The analysis period determines the number of years in the project [cash flow](#).

### Inflation Rate

Annual rate of change of costs, typically based on a price index, expressed as a percentage. SAM uses the inflation rate to calculate the value of costs in years two and later of the project cash flow based on Year One dollar values that you specify on the [System Costs](#) page, Financial Parameters page, [Electricity Rates](#) page, and [Incentives](#) page.

The default value of 2.5% is based on [consumer price index data from the U.S. Department of Labor Bureau of Labor Statistics](#), and is the average of the annual average consumer price index between 1991 and 2012.

The inflation rate may be either a positive or negative value.

### Real Discount Rate

A measure of the time value of money expressed as an annual percentage. SAM uses the real discount rate to calculate the present value (value in year one) of dollar amounts in the project cash flow over the analysis period and to calculate annualized costs.

SAM's financial model results are very sensitive to the real discount rate input. If you plan to use metrics like the net present value (NPV), levelized cost and PPA price, and internal rate of return, you should carefully consider the discount rate to use for your analysis. The default value is based on a reasonable guess for renewable energy projects in the United States. Because discount rates are very subjective and project developers are typically reluctant to share information about discount rates, published documents on renewable energy finance typically do not include detailed information about discount rates.

**Note.** For projects with one of the PPA financial models, SAM includes both a discount rate and internal rate of return (IRR) in the analysis. For these projects, the discount rate represents the value of an alternative investment, and the IRR can represent a profit requirement or the risk associated with the project. For example, the IRR may be higher than the discount rate for a renewable energy project with higher risk than an alternative investment.

### Nominal Discount Rate

SAM calculates the nominal discount based on the values of the real discount rate and the inflation rate:

$$\text{Nominal Discount Rate} = [ ( 1 + \text{Real Discount Rate} \div 100 ) \times ( 1 + \text{Inflation Rate} \div 100 ) - 1 ] \times 100$$

## Tax and Insurance Rates

### Federal and State Income Tax Rates

The annual federal and state income tax rate applies to taxable income and is used to calculate the project's tax benefits and liabilities.

You can specify either a single annual tax rate, or use the [Edit Schedule](#) window to specify a tax rate for each year. The latter option is useful for modeling a tax holiday where the tax rate for the first few years is zero.

For all projects, taxable income includes income from any incentives marked on the [Incentives](#) page as taxable.

For residential and commercial projects, SAM does not consider the value of electricity saved by the system to be taxable income. For commercial projects, because those savings represent the value of electricity purchases that would have been a tax-deductible operating expense to the commercial entity, SAM does reduce the project cash flow by the amount of federal and state income tax on the value of the electricity. In other words, with the renewable energy system in place, the commercial entity must pay tax on that portion of its income that it would have deducted as an operating expense.

For PPA projects, taxable income includes earnings before interest, taxes, depreciation and amortization (EBIDTA) and interest earned on reserve accounts. EBIDTA is revenue from electricity sales revenue (PPA revenue) less annual operation and maintenance, property tax, and insurance expenses.

### Sales Tax

The sales tax is a one-time tax that SAM includes in the project's total installed cost. SAM calculates the sales tax amount by multiplying the sales tax rate on the Financial Parameters page by the rate you specify under Indirect Capital Costs and the Total Direct Cost on the [System Costs](#) page.

For tax purposes, because SAM includes the sales tax amount in the total installed cost, it treats sales tax as part of the cost of property. For projects with depreciation (Commercial and PPA financial models only), SAM includes the sales tax amount in the depreciable basis. See IRS Publication 551, Basis of

Assets, for more details.

Some states and other jurisdictions offer a sales tax exemption for renewable energy projects. To model a sales tax exemption in SAM, reduce the sales tax percentage as appropriate. For example, for a 100% sales tax exemption, enter a sales tax rate of zero.

For projects with debt, because SAM includes the sales tax amount in the total installed cost, the sales tax influences the debt amount and debt interest payment. For projects where debt interest payments are deductible from federal and state income tax (all financial models except Residential with standard loan), SAM includes sales tax in the calculation of the deductions.

### Insurance Rate (Annual)

SAM treats annual insurance payments as part of the annual operating costs. The insurance cost in year one of the project cash flow is the insurance rate multiplied by the total installed cost from the [System Costs](#) page. The first year cost is then increased by inflation in each subsequent year. For commercial and PPA projects, the insurance cost is a tax-deductible operating expense.

## Property Tax

Property tax is an annual project expense that SAM includes under Operating Expenses in the [cash flow](#).

SAM treats property tax as a tax-deductible operating expense for each year. In each year of the project cash flow, the property tax cost is the property tax rate multiplied by the assessed value for that year.

SAM determines the annual property tax payment by calculating an assessed value for each year in the cash flow, and applying the assessed percent to that value. The assessed value may decline from year to year at the rate you specify. The assessed percent and tax rate both remain constant from year to year.

For residential projects, the property tax amount is the only operating cost that can be deducted from state and federal income tax.

### Assessed Percent

The assessed value of property subject to property taxes as a percentage of the system total installed cost specified on the [System Costs](#) page. SAM uses this value to calculate the assessed property value in year one of the project cash flow.

### Assessed Value

The assessed property value in Year One of the project cash flow:

$$\text{Assessed Value (\$)} = \text{Assessed Percent (\%)} \times \text{Total Installed Cost (\$)}$$

Where Total Installed Cost is from the [System Costs](#) page.

### Assessed Value Decline

The annual decline in the assessed property value. SAM uses this value to calculate the property assessed value in years two and later of the project cash flow. For an assessed value that does not decrease annually, specify a value of zero percent per year.

### Property Tax

The annual property tax rate applies to the assessed value of the project in each year of the project cash flow.

## Salvage Value

SAM considers the salvage value to be project income in the final year of the project cash flow, and calculates the value as a percentage of the total installed cost from the [System Costs](#) page.

For example, if you specify a 10% salvage value for a project with a 30-year analysis period, and total installed cost of \$1 million, SAM includes income in Year 30 of  $\$100,000 = \$1,000,000 \times 0.10$ .

For residential projects, the salvage value has no effect on federal and state income tax.

For commercial and PPA projects, the salvage value is treated as a source of pre-tax revenue in the final year of the analysis period, increasing the federal and state taxable income.

### Net Salvage Value

The salvage value as a percentage of the project's total installed cost from the [System Costs](#) page.

### End of Analysis Period Salvage Value

The salvage value dollar amount that will appear in final year of the project [cash flow](#).

$$\text{End of Analysis Period Salvage Value (\$)} = \text{Net Salvage Value (\%)} \times \text{Total Installed Cost (\$)}$$

Where *Total Installed Cost* is from the [System Costs](#) page.

## 26.3 Third Party - Host

The Third Party Ownership - Host model calculates the net present value (NPV) of a renewable energy system installed on a residential or commercial property. The property owner, or host, makes an agreement with a third party who installs, operates, and owns the system. The system reduces the host's electricity bill, and the host makes payments to the owner.

In a **power purchase agreement (PPA)**, the customer pays for the power generated by the system at a fixed rate called the PPA price. In a **lease agreement**, the host makes monthly lease payments on the system.

You can use the Third Party Ownership - Host model to:

- Compare the benefit of a lease agreement to a PPA from the host's perspective.
- Compare the Third Party Ownership - Host model to the Residential or Commercial model to compare third party ownership with direct ownership.
- Investigate the value of different electricity rate structures and load profiles under a third party ownership agreement.

For an overview of third party ownership financing, see the [Solar Energy Industries Association Issues and Policies page](#) on the topic.

SAM's Third Party Ownership - Host model makes the following assumptions:

- Project costs and benefits are from the host (residential or commercial property owner) perspective.
- For a lease agreement, the host makes monthly lease payments with an optional annual escalation rate. Inflation does not apply to lease payments.
- For a PPA, the host makes monthly payments for electricity generated by the system at the rate defined in the PPA with an optional annual escalation rate.
- Inflation does not apply to monthly payments for either the lease agreement or PPA.

**Note.** To explore a third party ownership power purchase agreement from the owner's perspective, use the [Third Party - Host / Developer model](#).

## Inputs

### Terms of Agreement

The terms of agreement determine how the host pays for the renewable energy system.

#### Lease agreement

The host makes fixed monthly lease payments for the system.

#### Power purchase agreement (PPA)

The host makes monthly payments for the electricity generated by the system.

#### First year monthly lease price

For a lease agreement, the amount of the host's fixed monthly payments in the first year of the agreement period.

#### Lease price escalation rate

For a lease agreement, the annual increase in the monthly lease payments. If the lease price is constant over the agreement period, enter an escalation rate of zero.

#### First year PPA price

For a PPA, the price of electricity generated by the system paid by the host in the first year of the agreement period.

#### PPA price escalation rate

For a PPA, the annual increase in the PPA price. If the PPA price is constant over the lease agreement period, enter an escalation rate of zero.

### Analysis Parameters

#### Agreement period

The number of years in the lease agreement or PPA. This is the period over which the system operates and the host makes payments to the third party owner.

#### Inflation rate

The annual rate of inflation. Inflation applies to the electricity rates paid by the host as defined on the [Electricity Rates](#) page. It does not apply to the lease payments.

#### Real discount rate

A measure of the time value of money expressed as an annual rate.

#### Nominal discount rate

SAM calculates the nominal discount based on the values of the real discount rate and the inflation rate, and uses this value to calculate the project's net present value (NPV):

$$\text{Nominal Discount Rate} = (1 + \text{Real Discount Rate}) \times (1 + \text{Inflation Rate}) - 1$$

## Results

### Metrics

The metrics appear in the [Metrics table](#) and in the [Data table](#) under **Single Value**.

### Net present value

The net present value (NPV) is the present value of the annual cash flow, and represents the net savings over the agreement term. In general, a positive NPV represents a project that generates enough savings to justify the agreement cost. A negative NPV indicates a project whose cost is greater than the savings.

## Annual Results

The annual results appear in the [Data table](#) under **Annual Data**.

### Annual cost

The annual cost of the agreement. For a lease agreement, it is the sum of monthly lease payments for each year in the agreement period. For a PPA, it is the sum of electricity payments for each year.

The annual cost is constant over the agreement period unless you specify an escalation rate for either the lease price or PPA price.

### Energy value in each year

The value of the electricity purchases offset by the renewable energy system, or the annual reduction in the host's electricity bill.

### Cash flow

The net cost of the agreement, equal to the annual savings minus lease payments.

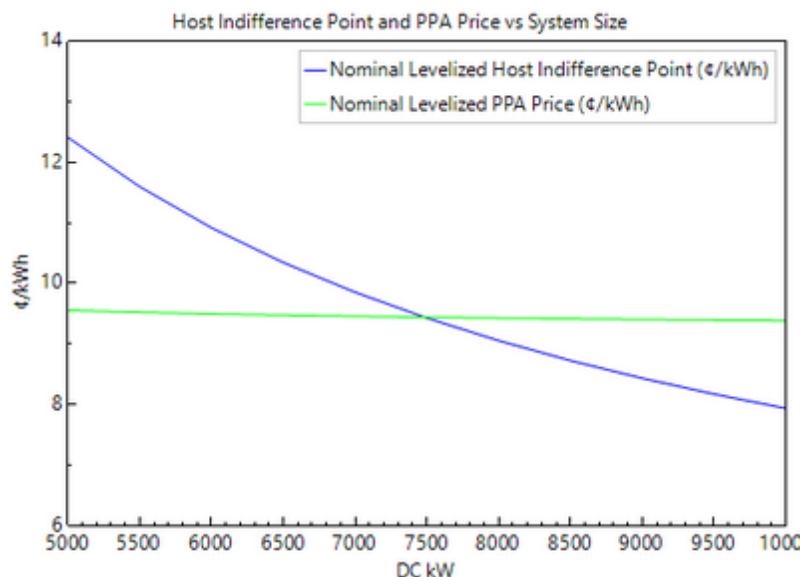
## 26.4 Third Party - Host / Developer

The Third Party Ownership - Host / Developer model calculates financial metrics a renewable energy system installed on a residential or commercial property. The property owner, or host, makes an agreement with a third party, or developer, who installs, operates, and owns the system. The system reduces the host's electricity bill, and the host makes payments to the developer for the power generated by the system at a fixed rate negotiated through a power purchase agreement or PPA.

You can use the Third Party Ownership - Host model to:

- Determine the PPA price that covers the developer's costs.
- Investigate the value of different electricity rate structures and load profiles under a third party ownership agreement.
- Compare the host's "indifference point" to the PPA price to compare the host cost and savings.

You can use the **Indifference vs PPA macro** to generate a graph of the [host indifference point](#) and [PPA price](#) over a range of system sizes to help determine how large the system would need to be to be economically feasible from the host's perspective:



For an overview of third party ownership financing, see the [Solar Energy Industries Association Issues and Policies page](#) on the topic.

**Note.** To explore a third party ownership power purchase from the host's perspective to compare a power purchase agreement to a lease agreement, use the [Third Party - Host](#) model.

## Solution Mode

The internal rate of return is the developer's rate of return. The PPA price is the price paid to the developer by the host for power generated by the system.

The Solution Mode inputs are where you determine how SAM calculates the PPA price, IRR, and other results that appear in the Metrics table on the [Summary](#) page.

The PPA price is the bid price in a power purchase agreement (PPA), and is the price that the project receives for each unit of electricity that the system generates. The internal rate of return (IRR) is a measure of the project's profitability, and is defined as the nominal discount rate that corresponds to a net present value (NPV) of zero.

The solution mode determines whether SAM calculates a PPA price based on an IRR target that you specify, or an IRR based on a PPA price that you specify:

- **Specify IRR Target** allows you to specify the IRR as an input, and SAM uses a search algorithm to find the PPA price required to meet the target IRR.
- **Specify PPA Price** allows you to specify the [PPA price](#) as an input, and SAM calculates the resulting [IRR](#).

### Solution Mode 1: Specify IRR Target

The Specify IRR Target option allows you to specify an IRR target value and the year that you would like the IRR to be achieved. SAM finds the [PPA price](#) required to meet the target given your assumptions including financial parameters, [incentives](#) and [depreciation](#), and the project's [system costs](#).

SAM uses an iterative algorithm to search for the PPA price that meets the IRR target in the year you specify. If it cannot find a solution, it finds the PPA price that results in an IRR and year as close as



possible to the target values.

### IRR target

The desired IRR target as a percentage:

- For the Single Owner model the required IRR is the project IRR.
- For the All Equity and Leveraged Partnership Flip and Sale Leaseback models, the target IRR is the tax investor IRR. SAM calculates the developer IRR as a function of the value in excess of the tax investor IRR.

### IRR target year

The year in which you want the target IRR to be achieved. For the partnership flip options, this is the flip year when project returns switch from the tax investor (pre-flip) to the developer (post-flip).

## Solution Mode 2: Specify PPA Price

The Specify PPA Price option allows you to specify the PPA price. SAM calculates the resulting [IRR](#):

- For the Single Owner model, SAM calculates the project IRR.
- For All Equity and Leveraged Partnership Flip, and Sale Leaseback models that involve two parties, SAM calculates two IRR values: One from the tax investor perspective, and one from the developer perspective. For the partnership flip options, SAM also calculates the flip year when project returns switch from the tax investor to the developer.

### PPA Price

The power price in dollars per kWh. This is the price that would be negotiated as part of a power purchase agreement.

**Note.** Regardless of the solution mode you choose, the PPA price is associated with the annual PPA price escalation rate if it increases from year to year, and the set of multipliers defined on the [Revenue](#) page. Be sure to use the "Uniform Dispatch" option for projects that do not involve time-of-delivery adjustments to the PPA price.

### IRR target year

The year you want to achieve the project IRR that SAM calculates.

## Escalation Rate

An escalation rate applied to the PPA price in Year One to calculate the power purchase price in years two and later in the project cash flow.

SAM does not apply the inflation rate to the PPA price. If you do not specify a PPA price escalation rate, SAM assumes that the same price applies in all years of the analysis period.

## Analysis Parameters

The analysis parameters specify the analysis period, inflation rate and discount rate.

### Analysis Period

Number of years covered by the analysis. Typically equivalent to the project or investment life. The analysis period determines the number of years in the project [cash flow](#).

### Inflation Rate

Annual rate of change of costs, typically based on a price index, expressed as a percentage. SAM uses the inflation rate to calculate the value of costs in years two and later of the project cash flow based on Year One dollar values that you specify on the [System Costs](#) page, Financial Parameters page, [Electricity Rates](#) page, and [Incentives](#) page.

The default value of 2.5% is based on [consumer price index data from the U.S. Department of Labor Bureau of Labor Statistics](#), and is the average of the annual average consumer price index between 1991 and 2012.

The inflation rate may be either a positive or negative value.

### Real Discount Rate

Specify the real discount rate for both the host and developer.

A measure of the time value of money expressed as an annual percentage. SAM uses the real discount rate to calculate the present value (value in year one) of dollar amounts in the project cash flow over the analysis period and to calculate annualized costs.

SAM's financial model results are very sensitive to the real discount rate input. If you plan to use metrics like the net present value (NPV), levelized cost of energy (LCOE) and PPA price, and internal rate of return, you should carefully consider the discount rate to use for your analysis. The default value is based on a reasonable guess for renewable energy projects in the United States. Because discount rates are very subjective and project developers are typically reluctant to share information about discount rates, published documents on renewable energy finance typically do not include detailed information about discount rates.

**Note.** For projects with one of the PPA financial models, SAM includes both a discount rate and internal rate of return (IRR) in the analysis. For these projects, the discount rate represents the value of an alternative investment, and the IRR can represent a profit requirement or the risk associated with the project. For example, the IRR may be higher than the discount rate for a renewable energy project with higher risk than an alternative investment.

### Nominal Discount Rate

SAM calculates the nominal discount based on the values of the real discount rate and the inflation rate:

$$\text{Nominal Discount Rate} = [ ( 1 + \text{Real Discount Rate} \div 100 ) \times ( 1 + \text{Inflation Rate} \div 100 ) - 1 ] \times 100$$

Project Tax and Insurance Rates

Salvage Value

Project Term Debt

## Taxes and Insurance Rates

### Federal and State Income Tax Rates

The annual federal and state income tax rate applies to taxable income and is used to calculate the project's tax benefits and liabilities.

You can specify either a single annual tax rate, or use the [Edit Schedule](#) window to specify a tax rate for each year. The latter option is useful for modeling a tax holiday where the tax rate for the first few years is zero.

For all projects, taxable income includes income from any incentives marked on the [Incentives](#) page as

taxable.

For residential and commercial projects, SAM does not consider the value of electricity saved by the system to be taxable income. For commercial projects, because those savings represent the value of electricity purchases that would have been a tax-deductible operating expense to the commercial entity, SAM does reduce the project cash flow by the amount of federal and state income tax on the value of the electricity. In other words, with the renewable energy system in place, the commercial entity must pay tax on that portion of its income that it would have deducted as an operating expense.

For PPA projects, taxable income includes earnings before interest, taxes, depreciation and amortization (EBIDTA) and interest earned on reserve accounts. EBIDTA is revenue from electricity sales revenue (PPA revenue) less annual operation and maintenance, property tax, and insurance expenses.

### **Sales Tax**

The sales tax is a one-time tax that SAM includes in the project's total installed cost. SAM calculates the sales tax amount by multiplying the sales tax rate on the Financial Parameters page by the rate you specify under Indirect Capital Costs and the Total Direct Cost on the [System Costs](#) page.

For tax purposes, because SAM includes the sales tax amount in the total installed cost, it treats sales tax as part of the cost of property. For projects with depreciation (Commercial and PPA financial models only), SAM includes the sales tax amount in the depreciable basis. See IRS Publication 551, Basis of Assets, for more details.

Some states and other jurisdictions offer a sales tax exemption for renewable energy projects. To model a sales tax exemption in SAM, reduce the sales tax percentage as appropriate. For example, for a 100% sales tax exemption, enter a sales tax rate of zero.

For projects with debt, because SAM includes the sales tax amount in the total installed cost, the sales tax influences the debt amount and debt interest payment. For projects where debt interest payments are deductible from federal and state income tax (all financial models except Residential with standard loan), SAM includes sales tax in the calculation of the deductions.

### **Insurance Rate (Annual)**

SAM treats annual insurance payments as part of the annual operating costs. The insurance cost in year one of the project cash flow is the insurance rate multiplied by the total installed cost from the [System Costs](#) page. The first year cost is then increased by inflation in each subsequent year. For commercial and PPA projects, the insurance cost is a tax-deductible operating expense.

## **Property Tax**

Property tax is an annual project expense that SAM includes under Operating Expenses in the [cash flow](#).

SAM treats property tax as a tax-deductible operating expense for each year. In each year of the project cash flow, the property tax cost is the property tax rate multiplied by the assessed value for that year.

SAM determines the annual property tax payment by calculating an assessed value for each year in the cash flow, and applying the assessed percent to that value. The assessed value may decline from year to year at the rate you specify. The assessed percent and tax rate both remain constant from year to year.

For residential projects, the property tax amount is the only operating cost that can be deducted from state and federal income tax.

### **Assessed Percent**

The assessed value of property subject to property taxes as a percentage of the system total installed cost specified on the [System Costs](#) page. SAM uses this value to calculate the assessed property value in year one of the project cash flow.

### Assessed Value

The assessed property value in Year One of the project cash flow:

$$\text{Assessed Value (\$)} = \text{Assessed Percent (\%)} \times \text{Total Installed Cost (\$)}$$

Where Total Installed Cost is from the [System Costs](#) page.

### Assessed Value Decline

The annual decline in the assessed property value. SAM uses this value to calculate the property assessed value in years two and later of the project cash flow. For an assessed value that does not decrease annually, specify a value of zero percent per year.

### Property Tax

The annual property tax rate applies to the assessed value of the project in each year of the project cash flow.

## Salvage Value

SAM considers the salvage value to be project income in the final year of the project cash flow, and calculates the value as a percentage of the total installed cost from the [System Costs](#) page.

For example, if you specify a 10% salvage value for a project with a 30-year analysis period, and total installed cost of \$1 million, SAM includes income in Year 30 of  $\$100,000 = \$1,000,000 \times 0.10$ .

For residential projects, the salvage value has no effect on federal and state income tax.

For commercial and PPA projects, the salvage value is treated as a source of pre-tax revenue in the final year of the analysis period, increasing the federal and state taxable income.

### Net Salvage Value

The salvage value as a percentage of the project's total installed cost from the [System Costs](#) page.

### End of Analysis Period Salvage Value

The salvage value dollar amount that will appear in final year of the project [cash flow](#).

$$\text{End of Analysis Period Salvage Value (\$)} = \text{Net Salvage Value (\%)} \times \text{Total Installed Cost (\$)}$$

Where *Total Installed Cost* is from the [System Costs](#) page.

## Construction Financing

SAM allows you to specify parameters for up to five construction loans to approximate interest during construction (IDC) that SAM considers to be a cost to the project.

SAM assumes that 100% of the construction balance is outstanding for half of the construction period, which is equivalent to an even monthly draw schedule with an average loan life of half of the construction period. To approximate a different draw schedule, you could adjust the loan's interest rate accordingly.

**Note.** To model a project with no construction period loans, set the **Percent of Installed Costs** value for each of the five loans to zero.

The construction financing cost is part of the project's [net capital cost](#). SAM includes the construction financing cost in the basis for calculating the basis for depreciation and the investment tax credit (ITC).

### Construction Loans

SAM allows you to specify up to five construction loans. You can type a name describing each loan or

use the default names.

### Percent of Installed Costs

The amount borrowed for the construction loan as a percentage of the total installed cost, assuming that all construction costs are included in the installation costs you specify on the System Costs page. Specify a non-zero percentage for each construction period loan you want to include in the analysis.

The sum of the up to five percentage values you specify for each construction loan must be 100%.

### Up-front Fee

A percentage of the principal amount, typically between 1% and 3% that SAM adds to the interest amount for each construction loan to calculate the total construction financing cost. Note that no interest applies to the up-front fee.

$$\text{Up-front Fee Amount (\$)} = \text{Principal Amount (\$)} \times \text{Up-front Fee Percentage (\%)}$$

### Months Prior to Operation

The loan period for the construction loan in months.

### Annual Interest Rate

The construction loan interest rate as an annual percentage.

### Principal

The amount borrowed for each construction period loan:

$$\text{Principal Amount (\$)} = \text{Total Installed Cost (\$)} \times \text{Percent of Installed Costs (\%)}$$

### Interest

The total interest payment due for each construction period loan, assuming that 100% of the construction balance is outstanding for half of the construction period.

$$\text{Interest (\$)} = \text{Principal Amount (\$)} \times \text{Loan Rate (\%/yr)} \div 12 \text{ (mos/yr)} \times \text{Months prior to operation} \div 2$$

### Total Construction Financing Cost

The total construction financing cost is part of the project's capital costs included in the [net capital cost](#) value in the Metrics table.

$$\text{Total Construction Financing Cost} = \text{Interest} + \text{Up-front Fee Amount}$$

## Project Term Debt

The Project Term Debt input variables determine the [size of debt](#) or amount borrowed, and debt-related costs. You can see the annual debt interest, principal and total payments on the [Cash Flow](#) tab of the [Results](#) page.

You can size the debt in one of two ways:

- **Debt percent:** Manually specify the size of debt as a fraction of the installed cost, adjusted to account for project costs and fees and for incentives. This option is appropriate for projects with mortgage-style debt, where annual total principal and interest payments are constant, and the annual debt-service coverage ratio (DSCR) varies from year to year.
- **DSCR:** Specify the debt service coverage ratio (DSCR), and allow SAM to size the debt based on cash available for debt service. This option is for projects with sculpted debt payments, where the total annual debt payment varies from year to year, and the annual DSCR is constant throughout the debt period.

**Debt percent**

The debt percent option allows you to specify the size of debt as a fraction of the installed cost.

$$\text{size of debt} = \text{debt percent} / 100 \times ( \text{total installed cost} \\ + \text{total construction financing cost} \\ - \text{total IBI amount} \\ - \text{total CBI amount} )$$

For this option, SAM assumes that the project makes constant annual debt payments given the size of debt (amount borrowed), tenor (payment period), and debt interest rate so that the debt service coverage ratio varies from year to year.

SAM displays the weighted average cost of capital (WACC) for reference (see below).

SAM reports the size of [debt](#) and minimum debt service coverage ratio in the Metrics table on the [Summary](#) page after you run simulations.

For the debt percent option, you can choose the amortization schedule:

**Equal payments (standard amortization)**

The size of annual debt payments remains constant over the debt payment period, the annual interest payment decreases each year with the unpaid balance, and the annual principal payment increases.

**Fixed principal declining interest**

The size of annual principal payments remains constant over the debt payment period, and the size of annual interest payments decreases with the unpaid balance so that the total annual payment decreases over the payment period.

For the debt percent option, you can also specify moratorium on debt principal payments:

**Moratorium**

The number of years starting at the beginning of the debt payment period (Year 1 of the project cash flow) before debt principal payments begin. For example, for a moratorium of 5 years and a 20-year debt period, principal payments would begin in Year 6 and end in Year 20.

**DSCR (Debt Service Coverage Ratio)**

The DSCR option allows you to specify the size of debt using the DSCR. The DSCR is the ratio of annual cash available for debt service (CAFDS) to the sum of the annual principal and interest payment. For a given year, the total annual debt payment (principal and interest) is:

$$\text{annual debt payment} = \text{CAFDS} \div \text{DSCR}$$

Annual cash available for debt service is equal to the earnings before interest, taxes, depreciation, and amortization (EBITDA) less cash used to fund the major equipment replacement reserves.

For this option, the size of debt (amount borrowed) is the present value of the annual CAFDS discounted at the debt interest rate.

SAM assumes that the debt service coverage ratio remains constant over the analysis period.

SAM reports the size of [debt](#) in the Metrics table on the Summary page after you run simulations.

**Tip.** The DSCR generally ranges between 1.40 and 1.50 for proven wind technology. For solar, the ratios are slightly lower: In the 1.30 to 1.40 range for PV, and perhaps slightly lower for CSP and CPV technologies.

**Tenor**

The debt period in years.

**Annual All-In Interest Rate**

Annual nominal debt interest rate.

**Debt Closing Costs**

A dollar amount representing debt closing costs. The debt closing costs are part of the project's capital costs included in the [net capital cost](#) value in the Metrics table.

**Up-Front Fee**

A percentage of the total debt representing debt closing costs. The up-front fee is part of the project's capital costs included in the [net capital cost](#) value in the Metrics table.

**WACC**

SAM displays the WACC for projects with debt when you specify the debt size as a debt percent. It is shown for reference and not used in any calculations.

This is a calculated value that you cannot directly edit. To change its value, change one of the parameters in the following equations:

$$WACC = [ \text{Nominal Discount Rate} \div 100 \times (1 - \text{Debt Percent} \div 100) + \text{Debt Percent} \div 100 \times \text{Loan Rate} \div 100 \times (1 - \text{Effective Tax Rate} \div 100) ] \times 100$$

See the **Nominal discount rate** variable description for its equation. The effective tax rate is a single number that includes both the federal income tax rate and state income tax rate. SAM uses the effective tax rate for several calculations requiring a total income tax value:

$$\text{Effective Tax Rate} = [ \text{Federal Tax Rate} \div 100 \times (1 - \text{State Tax Rate} \div 100) + \text{State Tax Rate} \div 100 ] \times 100$$

**Cost of Acquiring Financing**

The Cost of Acquiring Financing input values represent the cost of securing debt or the participation of tax investors. SAM includes the financing cost and development fees in the project's capital cost.

**Financing Cost (Single Owner only)**

The dollar amount associated with acquiring financing.

**Development Fee (All options except Single Owner)**

A fee paid to the developer in Year 0, specified as a percentage of the total installed cost on the [System Costs](#) page.

$$\text{Development Fee (\$)} = \text{Development Fee (\%)} \times \text{Total Installed Cost (\$)}$$

**Equity Closing Cost (All options except Single Owner)**

A dollar amount representing costs associated with securing participation of a tax investor, such as consultants and legal fees.

**Other Financing Costs (All options except Single Owner)**

A dollar amount for financing costs not included in the equity closing cost or development fee.

**Reserve Accounts**

Reserve accounts are funds set aside to cover unexpected costs. Project financial partners may require that the project owner(s) establish and fund reserve accounts. Reserve account funding is a project cost. Interest on reserves contribute to the project's cash flow.

### Interest on Reserves

Annual interest rate earned on funds in reserve accounts. The different financial models have different reserve accounts, and the interest on reserves rate applies to all of the accounts available for a given option:

- Working capital reserve account, specified under Cost of Acquiring Financing.
- Major equipment reserve account, specified under Major Equipment Replacement Reserves.
- Debt service reserve account (Leveraged Partnership Flip, Single Owner), specified under Debt Service.
- Lessee reserve account (Sale Leaseback), specified under Sale Leaseback.

### Working Capital Reserve Account

The working capital reserve account covers cash flow delays, and is sized in months of operating costs. The account is funded in Year zero, earns interest in Years 1 through the end of the analysis period. Funds are released at the end of the analysis period.

The size of the working capital reserve in months of operation.

$$\text{Working Capital Reserve Amount} = \text{Months of Operating Costs (months)} / 12 \text{ months/yr} \times \text{Year One Total Expenses (\$/yr)}$$

### Debt Service Reserve Account

A debt service reserve account is a fund that may be required by the project debt provider. The account is funded in Year 0 and earns interest in Years 1 and later at the reserve interest rate specified under Reserves. The funds in the account are released at the end of the debt period.

The number of months of principal and interest payments in Year One whose value is equivalent to the size of the debt reserve account in Year 0.

SAM calculates the reserve account size in Year 0 based on the principal and interest amounts in Year One:

$$\text{Year 0 Debt Service Reserve Amount} = (\text{Year One Principal (\$/yr)} + \text{Year One Interest (\$/yr)}) \times \text{Debt Service Reserve Account (months)} / 12 \text{ (months/yr)}$$

**Tip.** Debt Service Reserve Accounts for utility-scale projects are typically sized to cover 6 to 12 months of principal and interest payments.

### Major Equipment Replacement Reserve Accounts

Major equipment replacement reserves are funds that the project sets aside to cover the cost of replacing equipment during the analysis period. You can specify up to three replacement reserve accounts.

SAM assumes that the cost of each major equipment replacement is capitalized rather than expensed. You can specify a depreciation schedule for each the major equipment replacement cost.

SAM calculates the inflation-adjusted cost of each major equipment replacement and funds a reserve account in each of the replacement cycle. At the time of each major equipment replacement, funds are released from the reserve account in an amount sufficient to cover the expense.

**Note.** In SAM, equipment replacement reserve funding is separate from operation and maintenance costs that you specify on the [System Costs](#) page.



**Account Name**

The name of the reserve account for your reference. SAM reports value associated with each account in the cash flow and other graphs and tables using the name Reserve Account 1, 2, and 3, regardless of the name you enter.

**Replacement Cost**

The cost in Year One dollars per kW of nameplate capacity.

$$\text{Replacement Cost (\$)} = \text{Replacement Cost (Year One \$/kW)} \times \text{Nameplate Capacity (kW)}$$

**Replacement Frequency**

The frequency in years that the replacement cost occurs.

For example, a replacement cost of \$10,000 and frequency of 5 years results in an inflation-adjusted major equipment capital spending amount of \$10,000 occurring in Years 5, 10, 15, 20, etc.

**Depreciation Treatment For All Capital Expenditure**

Specify a federal and state depreciation method for the major equipment replacement cost.

SAM includes major equipment replacement reserves in the annual total depreciation amount in the cash flow.

**Return on Equity**

The Return on Equity input allows you to use SAM to calculate a percentage of the project equity in the results. The return on equity input does not affect the value of the net present value (NPV), levelized cost of energy (LCOE), PPA price, internal rate of return or other financial metrics.

For example, if you specify a return on equity of 15.5% for a project with \$100M of equity, the annual return on equity reported in the [Data tables](#) on the [Results](#) page is \$15.5M.

**Return on equity, %**

An annual percentage of the project equity representing. You can specify a single value or use the [Edit Schedule](#) window to specify values for each year of the project cash flow.

## 26.5 Single Owner

This topic describes the inputs on the Financial Parameters page for the Single Owner financial model. For a general description of the model, see [Financial Models](#).

**Analysis Parameters**

The analysis parameters specify the analysis period, inflation rate and discount rate.

**Analysis Period**

Number of years covered by the analysis. Typically equivalent to the project or investment life. The analysis period determines the number of years in the project [cash flow](#).

**Inflation Rate**

Annual rate of change of costs, typically based on a price index, expressed as a percentage. SAM uses the inflation rate to calculate the value of costs in years two and later of the project cash flow

based on Year One dollar values that you specify on the [System Costs](#) page, Financial Parameters page, [Electricity Rates](#) page, and [Incentives](#) page.

The default value of 2.5% is based on [consumer price index data from the U.S. Department of Labor Bureau of Labor Statistics](#), and is the average of the annual average consumer price index between 1991 and 2012.

The inflation rate may be either a positive or negative value.

### Real Discount Rate

A measure of the time value of money expressed as an annual percentage. SAM uses the real discount rate to calculate the present value (value in year one) of dollar amounts in the project cash flow over the analysis period and to calculate annualized costs.

SAM's financial model results are very sensitive to the real discount rate input. If you plan to use metrics like the net present value (NPV), levelized cost and PPA price, and internal rate of return, you should carefully consider the discount rate to use for your analysis. The default value is based on a reasonable guess for renewable energy projects in the United States. Because discount rates are very subjective and project developers are typically reluctant to share information about discount rates, published documents on renewable energy finance typically do not include detailed information about discount rates.

**Note.** For projects with one of the PPA financial models, SAM includes both a discount rate and internal rate of return (IRR) in the analysis. For these projects, the discount rate represents the value of an alternative investment, and the IRR can represent a profit requirement or the risk associated with the project. For example, the IRR may be higher than the discount rate for a renewable energy project with higher risk than an alternative investment.

### Nominal Discount Rate

SAM calculates the nominal discount based on the values of the real discount rate and the inflation rate:

$$\text{Nominal Discount Rate} = [ ( 1 + \text{Real Discount Rate} \div 100 ) \times ( 1 + \text{Inflation Rate} \div 100 ) - 1 ] \times 100$$

## Taxes and Insurance Rates

### Federal and State Income Tax Rates

The annual federal and state income tax rate applies to taxable income and is used to calculate the project's tax benefits and liabilities.

You can specify either a single annual tax rate, or use the [Edit Schedule](#) window to specify a tax rate for each year. The latter option is useful for modeling a tax holiday where the tax rate for the first few years is zero.

For all projects, taxable income includes income from any incentives marked on the [Incentives](#) page as taxable.

For residential and commercial projects, SAM does not consider the value of electricity saved by the system to be taxable income. For commercial projects, because those savings represent the value of electricity purchases that would have been a tax-deductible operating expense to the commercial entity, SAM does reduce the project cash flow by the amount of federal and state income tax on the value of the electricity. In other words, with the renewable energy system in place, the commercial entity must pay tax on that portion of its income that it would have deducted as an operating expense.

For PPA projects, taxable income includes earnings before interest, taxes, depreciation and

amortization (EBIDTA) and interest earned on reserve accounts. EBIDTA is revenue from electricity sales revenue (PPA revenue) less annual operation and maintenance, property tax, and insurance expenses.

### Sales Tax

The sales tax is a one-time tax that SAM includes in the project's total installed cost. SAM calculates the sales tax amount by multiplying the sales tax rate on the Financial Parameters page by the rate you specify under Indirect Capital Costs and the Total Direct Cost on the [System Costs](#) page.

For tax purposes, because SAM includes the sales tax amount in the total installed cost, it treats sales tax as part of the cost of property. For projects with depreciation (Commercial and PPA financial models only), SAM includes the sales tax amount in the depreciable basis. See IRS Publication 551, Basis of Assets, for more details.

Some states and other jurisdictions offer a sales tax exemption for renewable energy projects. To model a sales tax exemption in SAM, reduce the sales tax percentage as appropriate. For example, for a 100% sales tax exemption, enter a sales tax rate of zero.

For projects with debt, because SAM includes the sales tax amount in the total installed cost, the sales tax influences the debt amount and debt interest payment. For projects where debt interest payments are deductible from federal and state income tax (all financial models except Residential with standard loan), SAM includes sales tax in the calculation of the deductions.

### Insurance Rate (Annual)

SAM treats annual insurance payments as part of the annual operating costs. The insurance cost in year one of the project cash flow is the insurance rate multiplied by the total installed cost from the [System Costs](#) page. The first year cost is then increased by inflation in each subsequent year. For commercial and PPA projects, the insurance cost is a tax-deductible operating expense.

## Property Tax

Property tax is an annual project expense that SAM includes under Operating Expenses in the [cash flow](#).

SAM treats property tax as a tax-deductible operating expense for each year. In each year of the project cash flow, the property tax cost is the property tax rate multiplied by the assessed value for that year.

SAM determines the annual property tax payment by calculating an assessed value for each year in the cash flow, and applying the assessed percent to that value. The assessed value may decline from year to year at the rate you specify. The assessed percent and tax rate both remain constant from year to year.

For residential projects, the property tax amount is the only operating cost that can be deducted from state and federal income tax.

### Assessed Percent

The assessed value of property subject to property taxes as a percentage of the system total installed cost specified on the [System Costs](#) page. SAM uses this value to calculate the assessed property value in year one of the project cash flow.

### Assessed Value

The assessed property value in Year One of the project cash flow:

$$\text{Assessed Value (\$)} = \text{Assessed Percent (\%)} \times \text{Total Installed Cost (\$)}$$

Where Total Installed Cost is from the [System Costs](#) page.

### Assessed Value Decline

The annual decline in the assessed property value. SAM uses this value to calculate the property

assessed value in years two and later of the project cash flow. For an assessed value that does not decrease annually, specify a value of zero percent per year.

### Property Tax

The annual property tax rate applies to the assessed value of the project in each year of the project cash flow.

## Salvage Value

SAM considers the salvage value to be project income in the final year of the project cash flow, and calculates the value as a percentage of the total installed cost from the [System Costs](#) page.

For example, if you specify a 10% salvage value for a project with a 30-year analysis period, and total installed cost of \$1 million, SAM includes income in Year 30 of  $\$100,000 = \$1,000,000 \times 0.10$ .

For residential projects, the salvage value has no effect on federal and state income tax.

For commercial and PPA projects, the salvage value is treated as a source of pre-tax revenue in the final year of the analysis period, increasing the federal and state taxable income.

### Net Salvage Value

The salvage value as a percentage of the project's total installed cost from the [System Costs](#) page.

### End of Analysis Period Salvage Value

The salvage value dollar amount that will appear in final year of the project [cash flow](#).

$$\text{End of Analysis Period Salvage Value (\$)} = \text{Net Salvage Value (\%)} \times \text{Total Installed Cost (\$)}$$

Where *Total Installed Cost* is from the [System Costs](#) page.

## Construction Financing

SAM allows you to specify parameters for up to five construction loans to approximate interest during construction (IDC) that SAM considers to be a cost to the project.

SAM assumes that 100% of the construction balance is outstanding for half of the construction period, which is equivalent to an even monthly draw schedule with an average loan life of half of the construction period. To approximate a different draw schedule, you could adjust the loan's interest rate accordingly.

**Note.** To model a project with no construction period loans, set the **Percent of Installed Costs** value for each of the five loans to zero.

The construction financing cost is part of the project's [net capital cost](#). SAM includes the construction financing cost in the basis for calculating the basis for depreciation and the investment tax credit (ITC).

### Construction Loans

SAM allows you to specify up to five construction loans. You can type a name describing each loan or use the default names.

### Percent of Installed Costs

The amount borrowed for the construction loan as a percentage of the total installed cost, assuming that all construction costs are included in the installation costs you specify on the [System Costs](#) page. Specify a non-zero percentage for each construction period loan you want to include in the analysis.

The sum of the up to five percentage values you specify for each construction loan must be 100%.

**Up-front Fee**

A percentage of the principal amount, typically between 1% and 3% that SAM adds to the interest amount for each construction loan to calculate the total construction financing cost. Note that no interest applies to the up-front fee.

$$\text{Up-front Fee Amount (\$)} = \text{Principal Amount (\$)} \times \text{Up-front Fee Percentage (\%)}$$

**Months Prior to Operation**

The loan period for the construction loan in months.

**Annual Interest Rate**

The construction loan interest rate as an annual percentage.

**Principal**

The amount borrowed for each construction period loan:

$$\text{Principal Amount (\$)} = \text{Total Installed Cost (\$)} \times \text{Percent of Installed Costs (\%)}$$

**Interest**

The total interest payment due for each construction period loan, assuming that 100% of the construction balance is outstanding for half of the construction period.

$$\text{Interest (\$)} = \text{Principal Amount (\$)} \times \text{Loan Rate (\%/yr)} \div 12 \text{ (mos/yr)} \times \text{Months prior to operation} \div 2$$

**Total Construction Financing Cost**

The total construction financing cost is part of the project's capital costs included in the [net capital cost](#) value in the Metrics table.

$$\text{Total Construction Financing Cost} = \text{Interest} + \text{Up-front Fee Amount}$$

**Project Term Debt**

The Project Term Debt input variables determine the [size of debt](#) or amount borrowed, and debt-related costs. You can see the annual debt interest, principal and total payments on the [Cash Flow](#) tab of the [Results](#) page.

You can size the debt in one of two ways:

- **Debt percent:** Manually specify the size of debt as a fraction of the installed cost, adjusted to account for project costs and fees and for incentives. This option is appropriate for projects with mortgage-style debt, where annual total principal and interest payments are constant, and the annual debt-service coverage ratio (DSCR) varies from year to year.
- **DSCR:** Specify the debt service coverage ratio (DSCR), and allow SAM to size the debt based on cash available for debt service. This option is for projects with sculpted debt payments, where the total annual debt payment varies from year to year, and the annual DSCR is constant throughout the debt period.

**Debt percent**

The debt percent option allows you to specify the size of debt as a fraction of the installed cost.

$$\text{size of debt} = \text{debt percent} / 100 \times ( \text{total installed cost} \\ + \text{total construction financing cost} \\ - \text{total IBI amount} \\ - \text{total CBI amount} )$$

For this option, SAM assumes that the project makes constant annual debt payments given the size of

debt (amount borrowed), tenor (payment period), and debt interest rate so that the debt service coverage ratio varies from year to year.

SAM displays the weighted average cost of capital (WACC) for reference (see below).

SAM reports the size of [debt](#) and minimum debt service coverage ratio in the Metrics table on the [Summary](#) page after you run simulations.

For the debt percent option, you can choose the amortization schedule:

#### **Equal payments (standard amortization)**

The size of annual debt payments remains constant over the debt payment period, the annual interest payment decreases each year with the unpaid balance, and the annual principal payment increases.

#### **Fixed principal declining interest**

The size of annual principal payments remains constant over the debt payment period, and the size of annual interest payments decreases with the unpaid balance so that the total annual payment decreases over the payment period.

For the debt percent option, you can also specify moratorium on debt principal payments:

#### **Moratorium**

The number of years starting at the beginning of the debt payment period (Year 1 of the project cash flow) before debt principal payments begin. For example, for a moratorium of 5 years and a 20-year debt period, principal payments would begin in Year 6 and end in Year 20.

#### **DSCR (Debt Service Coverage Ratio)**

The DSCR option allows you to specify the size of debt using the DSCR. The DSCR is the ratio of annual cash available for debt service (CAFDS) to the sum of the annual principal and interest payment. For a given year, the total annual debt payment (principal and interest) is:

$$\text{annual debt payment} = \text{CAFDS} \div \text{DSCR}$$

Annual cash available for debt service is equal to the earnings before interest, taxes, depreciation, and amortization (EBITDA) less cash used to fund the major equipment replacement reserves.

For this option, the size of debt (amount borrowed) is the present value of the annual CAFDS discounted at the debt interest rate.

SAM assumes that the debt service coverage ratio remains constant over the analysis period.

SAM reports the size of [debt](#) in the Metrics table on the Summary page after you run simulations.

**Tip.** The DSCR generally ranges between 1.40 and 1.50 for proven wind technology. For solar, the ratios are slightly lower: In the 1.30 to 1.40 range for PV, and perhaps slightly lower for CSP and CPV technologies.

#### **Tenor**

The debt period in years.

#### **Annual All-In Interest Rate**

Annual nominal debt interest rate.

#### **Debt Closing Costs**

A dollar amount representing debt closing costs. The debt closing costs are part of the project's capital costs included in the [net capital cost](#) value in the Metrics table.

**Up-Front Fee**

A percentage of the total debt representing debt closing costs. The up-front fee is part of the project's capital costs included in the [net capital cost](#) value in the Metrics table.

**WACC**

SAM displays the WACC for projects with debt when you specify the debt size as a debt percent. It is shown for reference and not used in any calculations.

This is a calculated value that you cannot directly edit. To change its value, change one of the parameters in the following equations:

$$WACC = [ \text{Nominal Discount Rate} \div 100 \times (1 - \text{Debt Percent} \div 100) + \text{Debt Percent} \div 100 \times \text{Loan Rate} \div 100 \times (1 - \text{Effective Tax Rate} \div 100) ] \times 100$$

See the **Nominal discount rate** variable description for its equation. The effective tax rate is a single number that includes both the federal income tax rate and state income tax rate. SAM uses the effective tax rate for several calculations requiring a total income tax value:

$$\text{Effective Tax Rate} = [ \text{Federal Tax Rate} \div 100 \times (1 - \text{State Tax Rate} \div 100) + \text{State Tax Rate} \div 100 ] \times 100$$

**Cost of Acquiring Financing**

The Cost of Acquiring Financing input values represent the cost of securing debt or the participation of tax investors. SAM includes the financing cost and development fees in the project's capital cost.

**Financing Cost (Single Owner only)**

The dollar amount associated with acquiring financing.

**Development Fee (All options except Single Owner)**

A fee paid to the developer in Year 0, specified as a percentage of the total installed cost on the [System Costs](#) page.

$$\text{Development Fee (\$)} = \text{Development Fee (\%)} \times \text{Total Installed Cost (\$)}$$

**Equity Closing Cost (All options except Single Owner)**

A dollar amount representing costs associated with securing participation of a tax investor, such as consultants and legal fees.

**Other Financing Costs (All options except Single Owner)**

A dollar amount for financing costs not included in the equity closing cost or development fee.

**Reserve Accounts**

Reserve accounts are funds set aside to cover unexpected costs. Project financial partners may require that the project owner(s) establish and fund reserve accounts. Reserve account funding is a project cost. Interest on reserves contribute to the project's cash flow.

**Interest on Reserves**

Annual interest rate earned on funds in reserve accounts. The different financial models have different reserve accounts, and the interest on reserves rate applies to all of the accounts available for a given option:

- Working capital reserve account, specified under Cost of Acquiring Financing.
- Major equipment reserve account, specified under Major Equipment Replacement Reserves.

- Debt service reserve account (Leveraged Partnership Flip, Single Owner), specified under Debt Service.
- Lessee reserve account (Sale Leaseback), specified under Sale Leaseback.

### Working Capital Reserve Account

The working capital reserve account covers cash flow delays, and is sized in months of operating costs. The account is funded in Year zero, earns interest in Years 1 through the end of the analysis period. Funds are released at the end of the analysis period.

The size of the working capital reserve in months of operation.

$$\text{Working Capital Reserve Amount} = \text{Months of Operating Costs (months)} / 12 \text{ months/yr} \times \text{Year One Total Expenses (\$/yr)}$$

### Debt Service Reserve Account

A debt service reserve account is a fund that may be required by the project debt provider. The account is funded in Year 0 and earns interest in Years 1 and later at the reserve interest rate specified under Reserves. The funds in the account are released at the end of the debt period.

The number of months of principal and interest payments in Year One whose value is equivalent to the size of the debt reserve account in Year 0.

SAM calculates the reserve account size in Year 0 based on the principal and interest amounts in Year One:

$$\text{Year 0 Debt Service Reserve Amount} = (\text{Year One Principal (\$/yr)} + \text{Year One Interest (\$/yr)}) \times \text{Debt Service Reserve Account (months)} / 12 \text{ (months/yr)}$$

**Tip.** Debt Service Reserve Accounts for utility-scale projects are typically sized to cover 6 to 12 months of principal and interest payments.

## Major Equipment Replacement Reserve Accounts

Major equipment replacement reserves are funds that the project sets aside to cover the cost of replacing equipment during the analysis period. You can specify up to three replacement reserve accounts.

SAM assumes that the cost of each major equipment replacement is capitalized rather than expensed. You can specify a depreciation schedule for each the major equipment replacement cost.

SAM calculates the inflation-adjusted cost of each major equipment replacement and funds a reserve account in each of the replacement cycle. At the time of each major equipment replacement, funds are released from the reserve account in an amount sufficient to cover the expense.

**Note.** In SAM, equipment replacement reserve funding is separate from operation and maintenance costs that you specify on the [System Costs](#) page.

### Account Name

The name of the reserve account for your reference. SAM reports value associated with each account in the cash flow and other graphs and tables using the name Reserve Account 1, 2, and 3, regardless of the name you enter.

### Replacement Cost

The cost in Year One dollars per kW of nameplate capacity.

$$\text{Replacement Cost (\$)} = \text{Replacement Cost (Year One \$/kW)} \times \text{Nameplate Capacity (kW)}$$



### Replacement Frequency

The frequency in years that the replacement cost occurs.

For example, a replacement cost of \$10,000 and frequency of 5 years results in an inflation-adjusted major equipment capital spending amount of \$10,000 occurring in Years 5, 10, 15, 20, etc.

### Depreciation Treatment For All Capital Expenditure

Specify a federal and state depreciation method for the major equipment replacement cost.

SAM includes major equipment replacement reserves in the annual total depreciation amount in the cash flow.

## Return on Equity

The Return on Equity input allows you to use SAM to calculate a percentage of the project equity in the results. The return on equity input does not affect the value of the net present value (NPV), levelized cost of energy (LCOE), PPA price, internal rate of return or other financial metrics.

For example, if you specify a return on equity of 15.5% for a project with \$100M of equity, the annual return on equity reported in the [Data tables](#) on the [Results](#) page is \$15.5M.

### Return on equity, %

An annual percentage of the project equity representing. You can specify a single value or use the [Edit Schedule](#) window to specify values for each year of the project cash flow.

## 26.6 Merchant Plant

This topic describes the inputs on the Financial Parameters page for the Merchant Plant financial model. For a general description of the model, see [Financial Models](#).

### Analysis Parameters

The analysis parameters specify the analysis period, inflation rate and discount rate.

#### Analysis Period

Number of years covered by the analysis. Typically equivalent to the project or investment life. The analysis period determines the number of years in the project [cash flow](#).

#### Inflation Rate

Annual rate of change of costs, typically based on a price index, expressed as a percentage. SAM uses the inflation rate to calculate the value of costs in years two and later of the project cash flow based on Year One dollar values that you specify on the [System Costs](#) page, Financial Parameters page, [Electricity Rates](#) page, and [Incentives](#) page.

The default value of 2.5% is based on [consumer price index data from the U.S. Department of Labor Bureau of Labor Statistics](#), and is the average of the annual average consumer price index between 1991 and 2012.

The inflation rate may be either a positive or negative value.

### Real Discount Rate

A measure of the time value of money expressed as an annual percentage. SAM uses the real discount rate to calculate the present value (value in year one) of dollar amounts in the project cash flow over the analysis period and to calculate annualized costs.

SAM's financial model results are very sensitive to the real discount rate input. If you plan to use metrics like the net present value (NPV), levelized cost and PPA price, and internal rate of return, you should carefully consider the discount rate to use for your analysis. The default value is based on a reasonable guess for renewable energy projects in the United States. Because discount rates are very subjective and project developers are typically reluctant to share information about discount rates, published documents on renewable energy finance typically do not include detailed information about discount rates.

**Note.** For projects with one of the PPA financial models, SAM includes both a discount rate and internal rate of return (IRR) in the analysis. For these projects, the discount rate represents the value of an alternative investment, and the IRR can represent a profit requirement or the risk associated with the project. For example, the IRR may be higher than the discount rate for a renewable energy project with higher risk than an alternative investment.

### Nominal Discount Rate

SAM calculates the nominal discount based on the values of the real discount rate and the inflation rate:

$$\text{Nominal Discount Rate} = [ ( 1 + \text{Real Discount Rate} \div 100 ) \times ( 1 + \text{Inflation Rate} \div 100 ) - 1 ] \times 100$$

## Taxes and Insurance Rates

### Federal and State Income Tax Rates

The annual federal and state income tax rate applies to taxable income and is used to calculate the project's tax benefits and liabilities.

You can specify either a single annual tax rate, or use the [Edit Schedule](#) window to specify a tax rate for each year. The latter option is useful for modeling a tax holiday where the tax rate for the first few years is zero.

For all projects, taxable income includes income from any incentives marked on the [Incentives](#) page as taxable.

For residential and commercial projects, SAM does not consider the value of electricity saved by the system to be taxable income. For commercial projects, because those savings represent the value of electricity purchases that would have been a tax-deductible operating expense to the commercial entity, SAM does reduce the project cash flow by the amount of federal and state income tax on the value of the electricity. In other words, with the renewable energy system in place, the commercial entity must pay tax on that portion of its income that it would have deducted as an operating expense.

For PPA projects, taxable income includes earnings before interest, taxes, depreciation and amortization (EBIDTA) and interest earned on reserve accounts. EBIDTA is revenue from electricity sales revenue (PPA revenue) less annual operation and maintenance, property tax, and insurance expenses.

### Sales Tax

The sales tax is a one-time tax that SAM includes in the project's total installed cost. SAM calculates the sales tax amount by multiplying the sales tax rate on the Financial Parameters page by the rate

you specify under Indirect Capital Costs and the Total Direct Cost on the [System Costs](#) page.

For tax purposes, because SAM includes the sales tax amount in the total installed cost, it treats sales tax as part of the cost of property. For projects with depreciation (Commercial and PPA financial models only), SAM includes the sales tax amount in the depreciable basis. See IRS Publication 551, Basis of Assets, for more details.

Some states and other jurisdictions offer a sales tax exemption for renewable energy projects. To model a sales tax exemption in SAM, reduce the sales tax percentage as appropriate. For example, for a 100% sales tax exemption, enter a sales tax rate of zero.

For projects with debt, because SAM includes the sales tax amount in the total installed cost, the sales tax influences the debt amount and debt interest payment. For projects where debt interest payments are deductible from federal and state income tax (all financial models except Residential with standard loan), SAM includes sales tax in the calculation of the deductions.

### Insurance Rate (Annual)

SAM treats annual insurance payments as part of the annual operating costs. The insurance cost in year one of the project cash flow is the insurance rate multiplied by the total installed cost from the [System Costs](#) page. The first year cost is then increased by inflation in each subsequent year. For commercial and PPA projects, the insurance cost is a tax-deductible operating expense.

## Property Tax

Property tax is an annual project expense that SAM includes under Operating Expenses in the [cash flow](#).

SAM treats property tax as a tax-deductible operating expense for each year. In each year of the project cash flow, the property tax cost is the property tax rate multiplied by the assessed value for that year.

SAM determines the annual property tax payment by calculating an assessed value for each year in the cash flow, and applying the assessed percent to that value. The assessed value may decline from year to year at the rate you specify. The assessed percent and tax rate both remain constant from year to year.

For residential projects, the property tax amount is the only operating cost that can be deducted from state and federal income tax.

### Assessed Percent

The assessed value of property subject to property taxes as a percentage of the system total installed cost specified on the [System Costs](#) page. SAM uses this value to calculate the assessed property value in year one of the project cash flow.

### Assessed Value

The assessed property value in Year One of the project cash flow:

$$\text{Assessed Value (\$)} = \text{Assessed Percent (\%)} \times \text{Total Installed Cost (\$)}$$

Where Total Installed Cost is from the [System Costs](#) page.

### Assessed Value Decline

The annual decline in the assessed property value. SAM uses this value to calculate the property assessed value in years two and later of the project cash flow. For an assessed value that does not decrease annually, specify a value of zero percent per year.

### Property Tax

The annual property tax rate applies to the assessed value of the project in each year of the project cash flow.

## Salvage Value

SAM considers the salvage value to be project income in the final year of the project cash flow, and calculates the value as a percentage of the total installed cost from the [System Costs](#) page.

For example, if you specify a 10% salvage value for a project with a 30-year analysis period, and total installed cost of \$1 million, SAM includes income in Year 30 of  $\$100,000 = \$1,000,000 \times 0.10$ .

For residential projects, the salvage value has no effect on federal and state income tax.

For commercial and PPA projects, the salvage value is treated as a source of pre-tax revenue in the final year of the analysis period, increasing the federal and state taxable income.

### Net Salvage Value

The salvage value as a percentage of the project's total installed cost from the [System Costs](#) page.

### End of Analysis Period Salvage Value

The salvage value dollar amount that will appear in final year of the project [cash flow](#).

$$\text{End of Analysis Period Salvage Value (\$)} = \text{Net Salvage Value (\%)} \times \text{Total Installed Cost (\$)}$$

Where *Total Installed Cost* is from the [System Costs](#) page.

## Construction Financing

SAM allows you to specify parameters for up to five construction loans to approximate interest during construction (IDC) that SAM considers to be a cost to the project.

SAM assumes that 100% of the construction balance is outstanding for half of the construction period, which is equivalent to an even monthly draw schedule with an average loan life of half of the construction period. To approximate a different draw schedule, you could adjust the loan's interest rate accordingly.

**Note.** To model a project with no construction period loans, set the **Percent of Installed Costs** value for each of the five loans to zero.

The construction financing cost is part of the project's [net capital cost](#). SAM includes the construction financing cost in the basis for calculating the basis for depreciation and the investment tax credit (ITC).

### Construction Loans

SAM allows you to specify up to five construction loans. You can type a name describing each loan or use the default names.

### Percent of Installed Costs

The amount borrowed for the construction loan as a percentage of the total installed cost, assuming that all construction costs are included in the installation costs you specify on the System Costs page. Specify a non-zero percentage for each construction period loan you want to include in the analysis.

The sum of the up to five percentage values you specify for each construction loan must be 100%.

### Up-front Fee

A percentage of the principal amount, typically between 1% and 3% that SAM adds to the interest amount for each construction loan to calculate the total construction financing cost. Note that no interest applies to the up-front fee.

$$\text{Up-front Fee Amount (\$)} = \text{Principal Amount (\$)} \times \text{Up-front Fee Percentage (\%)}$$

**Months Prior to Operation**

The loan period for the construction loan in months.

**Annual Interest Rate**

The construction loan interest rate as an annual percentage.

**Principal**

The amount borrowed for each construction period loan:

$$\text{Principal Amount (\$)} = \text{Total Installed Cost (\$)} \times \text{Percent of Installed Costs (\%)}$$

**Interest**

The total interest payment due for each construction period loan, assuming that 100% of the construction balance is outstanding for half of the construction period.

$$\text{Interest (\$)} = \text{Principal Amount (\$)} \times \text{Loan Rate (\%/yr)} \div 12 \text{ (mos/yr)} \times \text{Months prior to operation} \div 2$$

**Total Construction Financing Cost**

The total construction financing cost is part of the project's capital costs included in the [net capital cost](#) value in the Metrics table.

$$\text{Total Construction Financing Cost} = \text{Interest} + \text{Up-front Fee Amount}$$

**Project Term Debt**

The Project Term Debt input variables determine the [size of debt](#) or amount borrowed, and debt-related costs. You can see the annual debt interest, principal and total payments on the [Cash Flow](#) tab of the [Results](#) page.

You can size the debt in one of two ways:

- **Debt percent:** Manually specify the size of debt as a fraction of the installed cost, adjusted to account for project costs and fees and for incentives. This option is appropriate for projects with mortgage-style debt, where annual total principal and interest payments are constant, and the annual debt-service coverage ratio (DSCR) varies from year to year.
- **DSCR:** Specify the debt service coverage ratio (DSCR), and allow SAM to size the debt based on cash available for debt service. This option is for projects with sculpted debt payments, where the total annual debt payment varies from year to year, and the annual DSCR is constant throughout the debt period.

**Debt percent**

The debt percent option allows you to specify the size of debt as a fraction of the installed cost.

$$\text{size of debt} = \text{debt percent} / 100 \times ( \text{total installed cost} \\ + \text{total construction financing cost} \\ - \text{total IBI amount} \\ - \text{total CBI amount} )$$

For this option, SAM assumes that the project makes constant annual debt payments given the size of debt (amount borrowed), tenor (payment period), and debt interest rate so that the debt service coverage ratio varies from year to year.

SAM displays the weighted average cost of capital (WACC) for reference (see below).

SAM reports the size of [debt](#) and minimum debt service coverage ratio in the Metrics table on the [Summary](#) page after you run simulations.

For the debt percent option, you can choose the amortization schedule:

**Equal payments (standard amortization)**

The size of annual debt payments remains constant over the debt payment period, the annual interest payment decreases each year with the unpaid balance, and the annual principal payment increases.

**Fixed principal declining interest**

The size of annual principal payments remains constant over the debt payment period, and the size of annual interest payments decreases with the unpaid balance so that the total annual payment decreases over the payment period.

For the debt percent option, you can also specify moratorium on debt principal payments:

**Moratorium**

The number of years starting at the beginning of the debt payment period (Year 1 of the project cash flow) before debt principal payments begin. For example, for a moratorium of 5 years and a 20-year debt period, principal payments would begin in Year 6 and end in Year 20.

**DSCR (Debt Service Coverage Ratio)**

The DSCR option allows you to specify the size of debt using the DSCR. The DSCR is the ratio of annual cash available for debt service (CAFDS) to the sum of the annual principal and interest payment. For a given year, the total annual debt payment (principal and interest) is:

$$\text{annual debt payment} = \text{CAFDS} \div \text{DSCR}$$

Annual cash available for debt service is equal to the earnings before interest, taxes, depreciation, and amortization (EBITDA) less cash used to fund the major equipment replacement reserves.

For this option, the size of debt (amount borrowed) is the present value of the annual CAFDS discounted at the debt interest rate.

SAM assumes that the debt service coverage ratio remains constant over the analysis period.

SAM reports the size of [debt](#) in the Metrics table on the Summary page after you run simulations.

**Tip.** The DSCR generally ranges between 1.40 and 1.50 for proven wind technology. For solar, the ratios are slightly lower: In the 1.30 to 1.40 range for PV, and perhaps slightly lower for CSP and CPV technologies.

**Tenor**

The debt period in years.

**Annual All-In Interest Rate**

Annual nominal debt interest rate.

**Debt Closing Costs**

A dollar amount representing debt closing costs. The debt closing costs are part of the project's capital costs included in the [net capital cost](#) value in the Metrics table.

**Up-Front Fee**

A percentage of the total debt representing debt closing costs. The up-front fee is part of the project's capital costs included in the [net capital cost](#) value in the Metrics table.

**WACC**

SAM displays the WACC for projects with debt when you specify the debt size as a debt percent. It is shown for reference and not used in any calculations.

This is a calculated value that you cannot directly edit. To change its value, change one of the parameters in the following equations:

$$WACC = [ \text{Nominal Discount Rate} \div 100 \times (1 - \text{Debt Percent} \div 100) + \text{Debt Percent} \div 100 \times \text{Loan Rate} \div 100 \times (1 - \text{Effective Tax Rate} \div 100) ] \times 100$$

See the **Nominal discount rate** variable description for its equation. The effective tax rate is a single number that includes both the federal income tax rate and state income tax rate. SAM uses the effective tax rate for several calculations requiring a total income tax value:

$$\text{Effective Tax Rate} = [ \text{Federal Tax Rate} \div 100 \times (1 - \text{State Tax Rate} \div 100) + \text{State Tax Rate} \div 100 ] \times 100$$

## Cost of Acquiring Financing

The Cost of Acquiring Financing input values represent the cost of securing debt or the participation of tax investors. SAM includes the financing cost and development fees in the project's capital cost.

### Financing Cost (Single Owner only)

The dollar amount associated with acquiring financing.

### Development Fee (All options except Single Owner)

A fee paid to the developer in Year 0, specified as a percentage of the total installed cost on the [System Costs](#) page.

$$\text{Development Fee (\$)} = \text{Development Fee (\%)} \times \text{Total Installed Cost (\$)}$$

### Equity Closing Cost (All options except Single Owner)

A dollar amount representing costs associated with securing participation of a tax investor, such as consultants and legal fees.

### Other Financing Costs (All options except Single Owner)

A dollar amount for financing costs not included in the equity closing cost or development fee.

## Reserve Accounts

Reserve accounts are funds set aside to cover unexpected costs. Project financial partners may require that the project owner(s) establish and fund reserve accounts. Reserve account funding is a project cost. Interest on reserves contribute to the project's cash flow.

### Interest on Reserves

Annual interest rate earned on funds in reserve accounts. The different financial models have different reserve accounts, and the interest on reserves rate applies to all of the accounts available for a given option:

- Working capital reserve account, specified under Cost of Acquiring Financing.
- Major equipment reserve account, specified under Major Equipment Replacement Reserves.
- Debt service reserve account (Leveraged Partnership Flip, Single Owner), specified under Debt Service.
- Lessee reserve account (Sale Leaseback), specified under Sale Leaseback.

### Working Capital Reserve Account

The working capital reserve account covers cash flow delays, and is sized in months of operating costs. The account is funded in Year zero, earns interest in Years 1 through the end of the analysis period.

Funds are released at the end of the analysis period.

The size of the working capital reserve in months of operation.

$$\text{Working Capital Reserve Amount} = \text{Months of Operating Costs (months)} / 12 \text{ months/yr} \times \text{Year One Total Expenses (\$/yr)}$$

### Debt Service Reserve Account

A debt service reserve account is a fund that may be required by the project debt provider. The account is funded in Year 0 and earns interest in Years 1 and later at the reserve interest rate specified under Reserves. The funds in the account are released at the end of the debt period.

The number of months of principal and interest payments in Year One whose value is equivalent to the size of the debt reserve account in Year 0.

SAM calculates the reserve account size in Year 0 based on the principal and interest amounts in Year One:

$$\text{Year 0 Debt Service Reserve Amount} = ( \text{Year One Principal (\$/yr)} + \text{Year One Interest (\$/yr)} ) \times \text{Debt Service Reserve Account (months)} / 12 \text{ (months/yr)}$$

**Tip.** Debt Service Reserve Accounts for utility-scale projects are typically sized to cover 6 to 12 months of principal and interest payments.

## Major Equipment Replacement Reserve Accounts

Major equipment replacement reserves are funds that the project sets aside to cover the cost of replacing equipment during the analysis period. You can specify up to three replacement reserve accounts.

SAM assumes that the cost of each major equipment replacement is capitalized rather than expensed. You can specify a depreciation schedule for each the major equipment replacement cost.

SAM calculates the inflation-adjusted cost of each major equipment replacement and funds a reserve account in each of the replacement cycle. At the time of each major equipment replacement, funds are released from the reserve account in an amount sufficient to cover the expense.

**Note.** In SAM, equipment replacement reserve funding is separate from operation and maintenance costs that you specify on the [System Costs](#) page.

### Account Name

The name of the reserve account for your reference. SAM reports value associated with each account in the cash flow and other graphs and tables using the name Reserve Account 1, 2, and 3, regardless of the name you enter.

### Replacement Cost

The cost in Year One dollars per kW of nameplate capacity.

$$\text{Replacement Cost (\$)} = \text{Replacement Cost (Year One \$/kW)} \times \text{Nameplate Capacity (kW)}$$

### Replacement Frequency

The frequency in years that the replacement cost occurs.

For example, a replacement cost of \$10,000 and frequency of 5 years results in an inflation-adjusted major equipment capital spending amount of \$10,000 occurring in Years 5, 10, 15, 20, etc.

### Depreciation Treatment For All Capital Expenditure

Specify a federal and state depreciation method for the major equipment replacement cost.



SAM includes major equipment replacement reserves in the annual total depreciation amount in the cash flow.

## Return on Equity

The Return on Equity input allows you to use SAM to calculate a percentage of the project equity in the results. The return on equity input does not affect the value of the net present value (NPV), levelized cost of energy (LCOE), PPA price, internal rate of return or other financial metrics.

For example, if you specify a return on equity of 15.5% for a project with \$100M of equity, the annual return on equity reported in the [Data tables](#) on the [Results](#) page is \$15.5M.

### Return on equity, %

An annual percentage of the project equity representing. You can specify a single value or use the [Edit Schedule](#) window to specify values for each year of the project cash flow.

## 26.7 Leveraged Partnership Flip

This topic describes the inputs on the Financial Parameters page for the Leveraged Partnership Flip financial model. For a general description of financial structures SAM can model, see [Financial Models](#).

SAM displays results of the financial model in the [cash flow](#). See [Cash Flow Variables](#) for details.

### Solution Mode

The Solution Mode inputs are where you determine how SAM calculates the PPA price, IRR, and other results that appear in the Metrics table on the [Summary](#) page.

The PPA price is the bid price in a power purchase agreement (PPA), and is the price that the project receives for each unit of electricity that the system generates. The internal rate of return (IRR) is a measure of the project's profitability, and is defined as the nominal discount rate that corresponds to a net present value (NPV) of zero.

The solution mode determines whether SAM calculates a PPA price based on an IRR target that you specify, or an IRR based on a PPA price that you specify:

- **Specify IRR Target** allows you to specify the IRR as an input, and SAM uses a search algorithm to find the PPA price required to meet the target IRR.
- **Specify PPA Price** allows you to specify the [PPA price](#) as an input, and SAM calculates the resulting [IRR](#).

### Solution Mode 1: Specify IRR Target

The Specify IRR Target option allows you to specify an IRR target value and the year that you would like the IRR to be achieved. SAM finds the [PPA price](#) required to meet the target given your assumptions including financial parameters, [incentives](#) and [depreciation](#), and the project's [system costs](#).

SAM uses an iterative algorithm to search for the PPA price that meets the IRR target in the year you specify. If it cannot find a solution, it finds the PPA price that results in an IRR and year as close as possible to the target values.

### IRR target

The desired IRR target as a percentage:

- For the Single Owner model the required IRR is the project IRR.
- For the All Equity and Leveraged Partnership Flip and Sale Leaseback models, the target IRR is the tax investor IRR. SAM calculates the developer IRR as a function of the value in excess of the tax investor IRR.

### IRR target year

The year in which you want the target IRR to be achieved. For the partnership flip options, this is the flip year when project returns switch from the tax investor (pre-flip) to the developer (post-flip).

## Solution Mode 2: Specify PPA Price

The Specify PPA Price option allows you to specify the PPA price. SAM calculates the resulting [IRR](#):

- For the Single Owner model, SAM calculates the project IRR.
- For All Equity and Leveraged Partnership Flip, and Sale Leaseback models that involve two parties, SAM calculates two IRR values: One from the tax investor perspective, and one from the developer perspective. For the partnership flip options, SAM also calculates the flip year when project returns switch from the tax investor to the developer.

### PPA Price

The power price in dollars per kWh. This is the price that would be negotiated as part of a power purchase agreement.

**Note.** Regardless of the solution mode you choose, the PPA price is associated with the annual PPA price escalation rate if it increases from year to year, and the set of multipliers defined on the [Revenue](#) page. Be sure to use the "Uniform Dispatch" option for projects that do not involve time-of-delivery adjustments to the PPA price.

### IRR target year

The year you want to achieve the project IRR that SAM calculates.

## Escalation Rate

An escalation rate applied to the PPA price in Year One to calculate the power purchase price in years two and later in the project cash flow.

SAM does not apply the inflation rate to the PPA price. If you do not specify a PPA price escalation rate, SAM assumes that the same price applies in all years of the analysis period.

## Equity Structure

The Equity Flip Structure variables determine how project income is divided between the tax investor and developer before and after the flip year.

The flip year is the year in the project cash flow that the tax investor IRR target is met. Typically, the majority of project cash and tax benefits is allocated to the tax investor before the flip year, and to the developer after the flip year. For example, the pre-flip tax investor share might be 98% (2% developer share), and the post-flip tax investor share might be 10% (90% developer share).

## Tax Investor

The tax investor's share of the project investment, revenue, and tax benefits before and after the flip year.

**Share of equity**

The tax investor's share of the project equity requirement as a percentage of:

- For Leveraged Partnership Flip, the total installed cost less the debt amount.
- For All Equity Partnership Flip, the total installed cost.

**Share of project cash, Pre-flip**

The percentage of annual project cash returns allocated to the tax investor in years before the flip target is reached.

**Share of project cash, Post-flip**

The percentage of annual project cash returns allocated to the tax investor in years after the flip target is reached.

**Share of tax benefits, Pre-flip**

The percentage of taxable income and any tax benefits, including depreciation-related tax losses and ITC-related tax credits, allocated to the tax investor before the flip target is reached.

**Share of tax benefits, Post-flip**

The percentage of taxable income and any tax benefits, including depreciation-related tax losses and ITC-related tax credits, allocated to the tax investor after the flip target is reached.

**Developer**

The developer's initial capital contribution and share of cash and tax flows are based on the tax investor quantities.

SAM calculates these values by subtracting the tax investor quantities from 100%. You cannot directly edit these values. To change the values, edit values under **Tax Investor**.

**Analysis Parameters**

The analysis parameters specify the analysis period, inflation rate and discount rate.

**Analysis Period**

Number of years covered by the analysis. Typically equivalent to the project or investment life. The analysis period determines the number of years in the project [cash flow](#).

**Inflation Rate**

Annual rate of change of costs, typically based on a price index, expressed as a percentage. SAM uses the inflation rate to calculate the value of costs in years two and later of the project cash flow based on Year One dollar values that you specify on the [System Costs](#) page, Financial Parameters page, [Electricity Rates](#) page, and [Incentives](#) page.

The default value of 2.5% is based on [consumer price index data from the U.S. Department of Labor Bureau of Labor Statistics](#), and is the average of the annual average consumer price index between 1991 and 2012.

The inflation rate may be either a positive or negative value.

**Real Discount Rate**

A measure of the time value of money expressed as an annual percentage. SAM uses the real discount rate to calculate the present value (value in year one) of dollar amounts in the project cash flow over the

analysis period and to calculate annualized costs.

SAM's financial model results are very sensitive to the real discount rate input. If you plan to use metrics like the net present value (NPV), levelized cost and PPA price, and internal rate of return, you should carefully consider the discount rate to use for your analysis. The default value is based on a reasonable guess for renewable energy projects in the United States. Because discount rates are very subjective and project developers are typically reluctant to share information about discount rates, published documents on renewable energy finance typically do not include detailed information about discount rates.

**Note.** For projects with one of the PPA financial models, SAM includes both a discount rate and internal rate of return (IRR) in the analysis. For these projects, the discount rate represents the value of an alternative investment, and the IRR can represent a profit requirement or the risk associated with the project. For example, the IRR may be higher than the discount rate for a renewable energy project with higher risk than an alternative investment.

### Nominal Discount Rate

SAM calculates the nominal discount based on the values of the real discount rate and the inflation rate:

$$\text{Nominal Discount Rate} = [ ( 1 + \text{Real Discount Rate} \div 100 ) \times ( 1 + \text{Inflation Rate} \div 100 ) - 1 ] \times 100$$

## Tax and Insurance Rates

### Federal and State Income Tax Rates

The annual federal and state income tax rate applies to taxable income and is used to calculate the project's tax benefits and liabilities.

You can specify either a single annual tax rate, or use the [Edit Schedule](#) window to specify a tax rate for each year. The latter option is useful for modeling a tax holiday where the tax rate for the first few years is zero.

For all projects, taxable income includes income from any incentives marked on the [Incentives](#) page as taxable.

For residential and commercial projects, SAM does not consider the value of electricity saved by the system to be taxable income. For commercial projects, because those savings represent the value of electricity purchases that would have been a tax-deductible operating expense to the commercial entity, SAM does reduce the project cash flow by the amount of federal and state income tax on the value of the electricity. In other words, with the renewable energy system in place, the commercial entity must pay tax on that portion of its income that it would have deducted as an operating expense.

For PPA projects, taxable income includes earnings before interest, taxes, depreciation and amortization (EBIDTA) and interest earned on reserve accounts. EBIDTA is revenue from electricity sales revenue (PPA revenue) less annual operation and maintenance, property tax, and insurance expenses.

### Sales Tax

The sales tax is a one-time tax that SAM includes in the project's total installed cost. SAM calculates the sales tax amount by multiplying the sales tax rate on the Financial Parameters page by the rate you specify under Indirect Capital Costs and the Total Direct Cost on the [System Costs](#) page.

For tax purposes, because SAM includes the sales tax amount in the total installed cost, it treats sales tax as part of the cost of property. For projects with depreciation (Commercial and PPA financial models

only), SAM includes the sales tax amount in the depreciable basis. See IRS Publication 551, Basis of Assets, for more details.

Some states and other jurisdictions offer a sales tax exemption for renewable energy projects. To model a sales tax exemption in SAM, reduce the sales tax percentage as appropriate. For example, for a 100% sales tax exemption, enter a sales tax rate of zero.

For projects with debt, because SAM includes the sales tax amount in the total installed cost, the sales tax influences the debt amount and debt interest payment. For projects where debt interest payments are deductible from federal and state income tax (all financial models except Residential with standard loan), SAM includes sales tax in the calculation of the deductions.

### Insurance Rate (Annual)

SAM treats annual insurance payments as part of the annual operating costs. The insurance cost in year one of the project cash flow is the insurance rate multiplied by the total installed cost from the [System Costs](#) page. The first year cost is then increased by inflation in each subsequent year. For commercial and PPA projects, the insurance cost is a tax-deductible operating expense.

## Property Tax

Property tax is an annual project expense that SAM includes under Operating Expenses in the [cash flow](#).

SAM treats property tax as a tax-deductible operating expense for each year. In each year of the project cash flow, the property tax cost is the property tax rate multiplied by the assessed value for that year.

SAM determines the annual property tax payment by calculating an assessed value for each year in the cash flow, and applying the assessed percent to that value. The assessed value may decline from year to year at the rate you specify. The assessed percent and tax rate both remain constant from year to year.

For residential projects, the property tax amount is the only operating cost that can be deducted from state and federal income tax.

### Assessed Percent

The assessed value of property subject to property taxes as a percentage of the system total installed cost specified on the [System Costs](#) page. SAM uses this value to calculate the assessed property value in year one of the project cash flow.

### Assessed Value

The assessed property value in Year One of the project cash flow:

$$\text{Assessed Value (\$)} = \text{Assessed Percent (\%)} \times \text{Total Installed Cost (\$)}$$

Where Total Installed Cost is from the [System Costs](#) page.

### Assessed Value Decline

The annual decline in the assessed property value. SAM uses this value to calculate the property assessed value in years two and later of the project cash flow. For an assessed value that does not decrease annually, specify a value of zero percent per year.

### Property Tax

The annual property tax rate applies to the assessed value of the project in each year of the project cash flow.

## Salvage Value

SAM considers the salvage value to be project income in the final year of the project cash flow, and

calculates the value as a percentage of the total installed cost from the [System Costs](#) page.

For example, if you specify a 10% salvage value for a project with a 30-year analysis period, and total installed cost of \$1 million, SAM includes income in Year 30 of  $\$100,000 = \$1,000,000 \times 0.10$ .

For residential projects, the salvage value has no effect on federal and state income tax.

For commercial and PPA projects, the salvage value is treated as a source of pre-tax revenue in the final year of the analysis period, increasing the federal and state taxable income.

### Net Salvage Value

The salvage value as a percentage of the project's total installed cost from the [System Costs](#) page.

### End of Analysis Period Salvage Value

The salvage value dollar amount that will appear in final year of the project [cash flow](#).

$$\text{End of Analysis Period Salvage Value (\$)} = \text{Net Salvage Value (\%)} \times \text{Total Installed Cost (\$)}$$

Where *Total Installed Cost* is from the [System Costs](#) page.

## Construction Financing

SAM allows you to specify parameters for up to five construction loans to approximate interest during construction (IDC) that SAM considers to be a cost to the project.

SAM assumes that 100% of the construction balance is outstanding for half of the construction period, which is equivalent to an even monthly draw schedule with an average loan life of half of the construction period. To approximate a different draw schedule, you could adjust the loan's interest rate accordingly.

**Note.** To model a project with no construction period loans, set the **Percent of Installed Costs** value for each of the five loans to zero.

The construction financing cost is part of the project's [net capital cost](#). SAM includes the construction financing cost in the basis for calculating the basis for depreciation and the investment tax credit (ITC).

### Construction Loans

SAM allows you to specify up to five construction loans. You can type a name describing each loan or use the default names.

### Percent of Installed Costs

The amount borrowed for the construction loan as a percentage of the total installed cost, assuming that all construction costs are included in the installation costs you specify on the [System Costs](#) page. Specify a non-zero percentage for each construction period loan you want to include in the analysis.

The sum of the up to five percentage values you specify for each construction loan must be 100%.

### Up-front Fee

A percentage of the principal amount, typically between 1% and 3% that SAM adds to the interest amount for each construction loan to calculate the total construction financing cost. Note that no interest applies to the up-front fee.

$$\text{Up-front Fee Amount (\$)} = \text{Principal Amount (\$)} \times \text{Up-front Fee Percentage (\%)}$$

### Months Prior to Operation

The loan period for the construction loan in months.

**Annual Interest Rate**

The construction loan interest rate as an annual percentage.

**Principal**

The amount borrowed for each construction period loan:

$$\text{Principal Amount (\$)} = \text{Total Installed Cost (\$)} \times \text{Percent of Installed Costs (\%)}$$

**Interest**

The total interest payment due for each construction period loan, assuming that 100% of the construction balance is outstanding for half of the construction period.

$$\text{Interest (\$)} = \text{Principal Amount (\$)} \times \text{Loan Rate (\%/yr)} \div 12 (\text{mos/yr}) \times \text{Months prior to operation} \div 2$$

**Total Construction Financing Cost**

The total construction financing cost is part of the project's capital costs included in the [net capital cost](#) value in the Metrics table.

$$\text{Total Construction Financing Cost} = \text{Interest} + \text{Up-front Fee Amount}$$

**Project Term Debt**

The Project Term Debt input variables determine the [size of debt](#) or amount borrowed, and debt-related costs. You can see the annual debt interest, principal and total payments on the [Cash Flow](#) tab of the [Results](#) page.

You can size the debt in one of two ways:

- **Debt percent:** Manually specify the size of debt as a fraction of the installed cost, adjusted to account for project costs and fees and for incentives. This option is appropriate for projects with mortgage-style debt, where annual total principal and interest payments are constant, and the annual debt-service coverage ratio (DSCR) varies from year to year.
- **DSCR:** Specify the debt service coverage ratio (DSCR), and allow SAM to size the debt based on cash available for debt service. This option is for projects with sculpted debt payments, where the total annual debt payment varies from year to year, and the annual DSCR is constant throughout the debt period.

**Debt percent**

The debt percent option allows you to specify the size of debt as a fraction of the installed cost.

$$\text{size of debt} = \text{debt percent} / 100 \times ( \text{total installed cost} \\ + \text{total construction financing cost} \\ - \text{total IBI amount} \\ - \text{total CBI amount} )$$

For this option, SAM assumes that the project makes constant annual debt payments given the size of debt (amount borrowed), tenor (payment period), and debt interest rate so that the debt service coverage ratio varies from year to year.

SAM displays the weighted average cost of capital (WACC) for reference (see below).

SAM reports the size of [debt](#) and minimum debt service coverage ratio in the Metrics table on the [Summary](#) page after you run simulations.

For the debt percent option, you can choose the amortization schedule:

**Equal payments (standard amortization)**

The size of annual debt payments remains constant over the debt payment period, the annual interest

payment decreases each year with the unpaid balance, and the annual principal payment increases.

**Fixed principal declining interest**

The size of annual principal payments remains constant over the debt payment period, and the size of annual interest payments decreases with the unpaid balance so that the total annual payment decreases over the payment period.

For the debt percent option, you can also specify moratorium on debt principal payments:

**Moratorium**

The number of years starting at the beginning of the debt payment period (Year 1 of the project cash flow) before debt principal payments begin. For example, for a moratorium of 5 years and a 20-year debt period, principal payments would begin in Year 6 and end in Year 20.

**DSCR (Debt Service Coverage Ratio)**

The DSCR option allows you to specify the size of debt using the DSCR. The DSCR is the ratio of annual cash available for debt service (CAFDS) to the sum of the annual principal and interest payment. For a given year, the total annual debt payment (principal and interest) is:

$$\text{annual debt payment} = \text{CAFDS} \div \text{DSCR}$$

Annual cash available for debt service is equal to the earnings before interest, taxes, depreciation, and amortization (EBITDA) less cash used to fund the major equipment replacement reserves.

For this option, the size of debt (amount borrowed) is the present value of the annual CAFDS discounted at the debt interest rate.

SAM assumes that the debt service coverage ratio remains constant over the analysis period.

SAM reports the size of [debt](#) in the Metrics table on the Summary page after you run simulations.

**Tip.** The DSCR generally ranges between 1.40 and 1.50 for proven wind technology. For solar, the ratios are slightly lower: In the 1.30 to 1.40 range for PV, and perhaps slightly lower for CSP and CPV technologies.

**Tenor**

The debt period in years.

**Annual All-In Interest Rate**

Annual nominal debt interest rate.

**Debt Closing Costs**

A dollar amount representing debt closing costs. The debt closing costs are part of the project's capital costs included in the [net capital cost](#) value in the Metrics table.

**Up-Front Fee**

A percentage of the total debt representing debt closing costs. The up-front fee is part of the project's capital costs included in the [net capital cost](#) value in the Metrics table.

**WACC**

SAM displays the WACC for projects with debt when you specify the debt size as a debt percent. It is shown for reference and not used in any calculations.

This is a calculated value that you cannot directly edit. To change its value, change one of the parameters in the following equations:

$$\text{WACC} = [ \text{Nominal Discount Rate} \div 100 \times (1 - \text{Debt Percent} \div 100) ]$$



$$+ \text{Debt Percent} \div 100 \times \text{Loan Rate} \div 100 \times (1 - \text{Effective Tax Rate} \div 100) ] \times 100$$

See the **Nominal discount rate** variable description for its equation. The effective tax rate is a single number that includes both the federal income tax rate and state income tax rate. SAM uses the effective tax rate for several calculations requiring a total income tax value:

$$\text{Effective Tax Rate} = [ \text{Federal Tax Rate} \div 100 \times (1 - \text{State Tax Rate} \div 100) + \text{State Tax Rate} \div 100 ] \times 100$$

## Cost of Acquiring Financing

The Cost of Acquiring Financing input values represent the cost of securing debt or the participation of tax investors. SAM includes the financing cost and development fees in the project's capital cost.

### Financing Cost (Single Owner only)

The dollar amount associated with acquiring financing.

### Development Fee (All options except Single Owner)

A fee paid to the developer in Year 0, specified as a percentage of the total installed cost on the [System Costs](#) page.

$$\text{Development Fee (\$)} = \text{Development Fee (\%)} \times \text{Total Installed Cost (\$)}$$

### Equity Closing Cost (All options except Single Owner)

A dollar amount representing costs associated with securing participation of a tax investor, such as consultants and legal fees.

### Other Financing Costs (All options except Single Owner)

A dollar amount for financing costs not included in the equity closing cost or development fee.

## Reserve Accounts

Reserve accounts are funds set aside to cover unexpected costs. Project financial partners may require that the project owner(s) establish and fund reserve accounts. Reserve account funding is a project cost. Interest on reserves contribute to the project's cash flow.

### Interest on Reserves

Annual interest rate earned on funds in reserve accounts. The different financial models have different reserve accounts, and the interest on reserves rate applies to all of the accounts available for a given option:

- Working capital reserve account, specified under Cost of Acquiring Financing.
- Major equipment reserve account, specified under Major Equipment Replacement Reserves.
- Debt service reserve account (Leveraged Partnership Flip, Single Owner), specified under Debt Service.
- Lessee reserve account (Sale Leaseback), specified under Sale Leaseback.

### Working Capital Reserve Account

The working capital reserve account covers cash flow delays, and is sized in months of operating costs. The account is funded in Year zero, earns interest in Years 1 through the end of the analysis period. Funds are released at the end of the analysis period.

The size of the working capital reserve in months of operation.

$$\text{Working Capital Reserve Amount} = \text{Months of Operating Costs (months)} / 12 \text{ months/yr} \times \text{Year One Total Expenses (\$/yr)}$$

### Debt Service Reserve Account

A debt service reserve account is a fund that may be required by the project debt provider. The account is funded in Year 0 and earns interest in Years 1 and later at the reserve interest rate specified under Reserves. The funds in the account are released at the end of the debt period.

The number of months of principal and interest payments in Year One whose value is equivalent to the size of the debt reserve account in Year 0.

SAM calculates the reserve account size in Year 0 based on the principal and interest amounts in Year One:

$$\text{Year 0 Debt Service Reserve Amount} = ( \text{Year One Principal (\$/yr)} + \text{Year One Interest (\$/yr)} ) \times \text{Debt Service Reserve Account (months)} / 12 \text{ (months/yr)}$$

**Tip.** Debt Service Reserve Accounts for utility-scale projects are typically sized to cover 6 to 12 months of principal and interest payments.

## Major Equipment Replacement Reserve Accounts

Major equipment replacement reserves are funds that the project sets aside to cover the cost of replacing equipment during the analysis period. You can specify up to three replacement reserve accounts.

SAM assumes that the cost of each major equipment replacement is capitalized rather than expensed. You can specify a depreciation schedule for each the major equipment replacement cost.

SAM calculates the inflation-adjusted cost of each major equipment replacement and funds a reserve account in each of the replacement cycle. At the time of each major equipment replacement, funds are released from the reserve account in an amount sufficient to cover the expense.

**Note.** In SAM, equipment replacement reserve funding is separate from operation and maintenance costs that you specify on the [System Costs](#) page.

### Account Name

The name of the reserve account for your reference. SAM reports value associated with each account in the cash flow and other graphs and tables using the name Reserve Account 1, 2, and 3, regardless of the name you enter.

### Replacement Cost

The cost in Year One dollars per kW of nameplate capacity.

$$\text{Replacement Cost (\$)} = \text{Replacement Cost (Year One \$/kW)} \times \text{Nameplate Capacity (kW)}$$

### Replacement Frequency

The frequency in years that the replacement cost occurs.

For example, a replacement cost of \$10,000 and frequency of 5 years results in an inflation-adjusted major equipment capital spending amount of \$10,000 occurring in Years 5, 10, 15, 20, etc.

### Depreciation Treatment For All Capital Expenditure

Specify a federal and state depreciation method for the major equipment replacement cost.

SAM includes major equipment replacement reserves in the annual total depreciation amount in the cash flow.

## 26.8 All Equity Partnership Flip

This topic describes the inputs on the Financial Parameters page for the All Equity Partnership Flip financial model. For a general description of financial structures SAM can model, see [Financial Models](#).

SAM displays results of the financial model in the [cash flow](#). See [Cash Flow Variables](#) for details.

### Solution Mode

The Solution Mode inputs are where you determine how SAM calculates the PPA price, IRR, and other results that appear in the Metrics table on the [Summary](#) page.

The PPA price is the bid price in a power purchase agreement (PPA), and is the price that the project receives for each unit of electricity that the system generates. The internal rate of return (IRR) is a measure of the project's profitability, and is defined as the nominal discount rate that corresponds to a net present value (NPV) of zero.

The solution mode determines whether SAM calculates a PPA price based on an IRR target that you specify, or an IRR based on a PPA price that you specify:

- **Specify IRR Target** allows you to specify the IRR as an input, and SAM uses a search algorithm to find the PPA price required to meet the target IRR.
- **Specify PPA Price** allows you to specify the [PPA price](#) as an input, and SAM calculates the resulting [IRR](#).

### Solution Mode 1: Specify IRR Target

The Specify IRR Target option allows you to specify an IRR target value and the year that you would like the IRR to be achieved. SAM finds the [PPA price](#) required to meet the target given your assumptions including financial parameters, [incentives](#) and [depreciation](#), and the project's [system costs](#).

SAM uses an iterative algorithm to search for the PPA price that meets the IRR target in the year you specify. If it cannot find a solution, it finds the PPA price that results in an IRR and year as close as possible to the target values.

#### IRR target

The desired IRR target as a percentage:

- For the Single Owner model the required IRR is the project IRR.
- For the All Equity and Leveraged Partnership Flip and Sale Leaseback models, the target IRR is the tax investor IRR. SAM calculates the developer IRR as a function of the value in excess of the tax investor IRR.

#### IRR target year

The year in which you want the target IRR to be achieved. For the partnership flip options, this is the flip year when project returns switch from the tax investor (pre-flip) to the developer (post-flip).

### Solution Mode 2: Specify PPA Price

The Specify PPA Price option allows you to specify the PPA price. SAM calculates the resulting [IRR](#):

- For the Single Owner model, SAM calculates the project IRR.

- For All Equity and Leveraged Partnership Flip, and Sale Leaseback models that involve two parties, SAM calculates two IRR values: One from the tax investor perspective, and one from the developer perspective. For the partnership flip options, SAM also calculates the flip year when project returns switch from the tax investor to the developer.

### PPA Price

The power price in dollars per kWh. This is the price that would be negotiated as part of a power purchase agreement.

**Note.** Regardless of the solution mode you choose, the PPA price is associated with the annual PPA price escalation rate if it increases from year to year, and the set of multipliers defined on the [Revenue](#) page. Be sure to use the "Uniform Dispatch" option for projects that do not involve time-of-delivery adjustments to the PPA price.

### IRR target year

The year you want to achieve the project IRR that SAM calculates.

### Escalation Rate

An escalation rate applied to the PPA price in Year One to calculate the power purchase price in years two and later in the project cash flow.

SAM does not apply the inflation rate to the PPA price. If you do not specify a PPA price escalation rate, SAM assumes that the same price applies in all years of the analysis period.

### Equity Structure

The Equity Flip Structure variables determine how project income is divided between the tax investor and developer before and after the flip year.

The flip year is the year in the project cash flow that the tax investor IRR target is met. Typically, the majority of project cash and tax benefits is allocated to the tax investor before the flip year, and to the developer after the flip year. For example, the pre-flip tax investor share might be 98% (2% developer share), and the post-flip tax investor share might be 10% (90% developer share).

### Tax Investor

The tax investor's share of the project investment, revenue, and tax benefits before and after the flip year.

#### Share of equity

The tax investor's share of the project equity requirement as a percentage of:

- For Leveraged Partnership Flip, the total installed cost less the debt amount.
- For All Equity Partnership Flip, the total installed cost.

#### Share of project cash, Pre-flip

The percentage of annual project cash returns allocated to the tax investor in years before the flip target is reached.

#### Share of project cash, Post-flip

The percentage of annual project cash returns allocated to the tax investor in years after the flip target is reached.

**Share of tax benefits, Pre-flip**

The percentage of taxable income and any tax benefits, including depreciation-related tax losses and ITC-related tax credits, allocated to the tax investor before the flip target is reached.

**Share of tax benefits, Post-flip**

The percentage of taxable income and any tax benefits, including depreciation-related tax losses and ITC-related tax credits, allocated to the tax investor after the flip target is reached.

**Developer**

The developer's initial capital contribution and share of cash and tax flows are based on the tax investor quantities.

SAM calculates these values by subtracting the tax investor quantities from 100%. You cannot directly edit these values. To change the values, edit values under **Tax Investor**.

**Developer Capital Recovery**

The Developer Capital Recovery options determine the timing of cash flows to the developer.

During the capital recovery period, the developer cannot receive an amount of cash greater than its initial investment.

**Time**

Choose this option to specify the duration of the developer's capital recovery period.

**Full Capital Recovery**

Choose this option to allocate 100% of the project cash flow to the developer until the developer recovers its investment. Note that there is no return on investment, just a return of investment.

**Duration**

The number of years during which the developer receives 100% of the project cash flow. If the number of years exceeds the time required for full capital recovery the developer only receives 100% of the project cash for years up to the year the developer recovers its investment.

**Analysis Parameters**

The analysis parameters specify the analysis period, inflation rate and discount rate.

**Analysis Period**

Number of years covered by the analysis. Typically equivalent to the project or investment life. The analysis period determines the number of years in the project [cash flow](#).

**Inflation Rate**

Annual rate of change of costs, typically based on a price index, expressed as a percentage. SAM uses the inflation rate to calculate the value of costs in years two and later of the project cash flow based on Year One dollar values that you specify on the [System Costs](#) page, Financial Parameters page, [Electricity Rates](#) page, and [Incentives](#) page.

The default value of 2.5% is based on [consumer price index data from the U.S. Department of Labor Bureau of Labor Statistics](#), and is the average of the annual average consumer price index between 1991 and 2012.

The inflation rate may be either a positive or negative value.

### Real Discount Rate

A measure of the time value of money expressed as an annual percentage. SAM uses the real discount rate to calculate the present value (value in year one) of dollar amounts in the project cash flow over the analysis period and to calculate annualized costs.

SAM's financial model results are very sensitive to the real discount rate input. If you plan to use metrics like the net present value (NPV), levelized cost and PPA price, and internal rate of return, you should carefully consider the discount rate to use for your analysis. The default value is based on a reasonable guess for renewable energy projects in the United States. Because discount rates are very subjective and project developers are typically reluctant to share information about discount rates, published documents on renewable energy finance typically do not include detailed information about discount rates.

**Note.** For projects with one of the PPA financial models, SAM includes both a discount rate and internal rate of return (IRR) in the analysis. For these projects, the discount rate represents the value of an alternative investment, and the IRR can represent a profit requirement or the risk associated with the project. For example, the IRR may be higher than the discount rate for a renewable energy project with higher risk than an alternative investment.

### Nominal Discount Rate

SAM calculates the nominal discount based on the values of the real discount rate and the inflation rate:

$$\text{Nominal Discount Rate} = [ ( 1 + \text{Real Discount Rate} \div 100 ) \times ( 1 + \text{Inflation Rate} \div 100 ) - 1 ] \times 100$$

## Tax and Insurance Rates

### Federal and State Income Tax Rates

The annual federal and state income tax rate applies to taxable income and is used to calculate the project's tax benefits and liabilities.

You can specify either a single annual tax rate, or use the [Edit Schedule](#) window to specify a tax rate for each year. The latter option is useful for modeling a tax holiday where the tax rate for the first few years is zero.

For all projects, taxable income includes income from any incentives marked on the [Incentives](#) page as taxable.

For residential and commercial projects, SAM does not consider the value of electricity saved by the system to be taxable income. For commercial projects, because those savings represent the value of electricity purchases that would have been a tax-deductible operating expense to the commercial entity, SAM does reduce the project cash flow by the amount of federal and state income tax on the value of the electricity. In other words, with the renewable energy system in place, the commercial entity must pay tax on that portion of its income that it would have deducted as an operating expense.

For PPA projects, taxable income includes earnings before interest, taxes, depreciation and amortization (EBIDTA) and interest earned on reserve accounts. EBIDTA is revenue from electricity sales revenue (PPA revenue) less annual operation and maintenance, property tax, and insurance expenses.

### Sales Tax

The sales tax is a one-time tax that SAM includes in the project's total installed cost. SAM calculates the sales tax amount by multiplying the sales tax rate on the Financial Parameters page by the rate

you specify under Indirect Capital Costs and the Total Direct Cost on the [System Costs](#) page.

For tax purposes, because SAM includes the sales tax amount in the total installed cost, it treats sales tax as part of the cost of property. For projects with depreciation (Commercial and PPA financial models only), SAM includes the sales tax amount in the depreciable basis. See IRS Publication 551, Basis of Assets, for more details.

Some states and other jurisdictions offer a sales tax exemption for renewable energy projects. To model a sales tax exemption in SAM, reduce the sales tax percentage as appropriate. For example, for a 100% sales tax exemption, enter a sales tax rate of zero.

For projects with debt, because SAM includes the sales tax amount in the total installed cost, the sales tax influences the debt amount and debt interest payment. For projects where debt interest payments are deductible from federal and state income tax (all financial models except Residential with standard loan), SAM includes sales tax in the calculation of the deductions.

### Insurance Rate (Annual)

SAM treats annual insurance payments as part of the annual operating costs. The insurance cost in year one of the project cash flow is the insurance rate multiplied by the total installed cost from the [System Costs](#) page. The first year cost is then increased by inflation in each subsequent year. For commercial and PPA projects, the insurance cost is a tax-deductible operating expense.

## Property Tax

Property tax is an annual project expense that SAM includes under Operating Expenses in the [cash flow](#).

SAM treats property tax as a tax-deductible operating expense for each year. In each year of the project cash flow, the property tax cost is the property tax rate multiplied by the assessed value for that year.

SAM determines the annual property tax payment by calculating an assessed value for each year in the cash flow, and applying the assessed percent to that value. The assessed value may decline from year to year at the rate you specify. The assessed percent and tax rate both remain constant from year to year.

For residential projects, the property tax amount is the only operating cost that can be deducted from state and federal income tax.

### Assessed Percent

The assessed value of property subject to property taxes as a percentage of the system total installed cost specified on the [System Costs](#) page. SAM uses this value to calculate the assessed property value in year one of the project cash flow.

### Assessed Value

The assessed property value in Year One of the project cash flow:

$$\text{Assessed Value (\$)} = \text{Assessed Percent (\%)} \times \text{Total Installed Cost (\$)}$$

Where Total Installed Cost is from the [System Costs](#) page.

### Assessed Value Decline

The annual decline in the assessed property value. SAM uses this value to calculate the property assessed value in years two and later of the project cash flow. For an assessed value that does not decrease annually, specify a value of zero percent per year.

### Property Tax

The annual property tax rate applies to the assessed value of the project in each year of the project cash flow.

## Salvage Value

SAM considers the salvage value to be project income in the final year of the project cash flow, and calculates the value as a percentage of the total installed cost from the [System Costs](#) page.

For example, if you specify a 10% salvage value for a project with a 30-year analysis period, and total installed cost of \$1 million, SAM includes income in Year 30 of  $\$100,000 = \$1,000,000 \times 0.10$ .

For residential projects, the salvage value has no effect on federal and state income tax.

For commercial and PPA projects, the salvage value is treated as a source of pre-tax revenue in the final year of the analysis period, increasing the federal and state taxable income.

### Net Salvage Value

The salvage value as a percentage of the project's total installed cost from the [System Costs](#) page.

### End of Analysis Period Salvage Value

The salvage value dollar amount that will appear in final year of the project [cash flow](#).

$$\text{End of Analysis Period Salvage Value (\$)} = \text{Net Salvage Value (\%)} \times \text{Total Installed Cost (\$)}$$

Where *Total Installed Cost* is from the [System Costs](#) page.

## Construction Financing

SAM allows you to specify parameters for up to five construction loans to approximate interest during construction (IDC) that SAM considers to be a cost to the project.

SAM assumes that 100% of the construction balance is outstanding for half of the construction period, which is equivalent to an even monthly draw schedule with an average loan life of half of the construction period. To approximate a different draw schedule, you could adjust the loan's interest rate accordingly.

**Note.** To model a project with no construction period loans, set the **Percent of Installed Costs** value for each of the five loans to zero.

The construction financing cost is part of the project's [net capital cost](#). SAM includes the construction financing cost in the basis for calculating the basis for depreciation and the investment tax credit (ITC).

### Construction Loans

SAM allows you to specify up to five construction loans. You can type a name describing each loan or use the default names.

### Percent of Installed Costs

The amount borrowed for the construction loan as a percentage of the total installed cost, assuming that all construction costs are included in the installation costs you specify on the System Costs page. Specify a non-zero percentage for each construction period loan you want to include in the analysis.

The sum of the up to five percentage values you specify for each construction loan must be 100%.

### Up-front Fee

A percentage of the principal amount, typically between 1% and 3% that SAM adds to the interest amount for each construction loan to calculate the total construction financing cost. Note that no interest applies to the up-front fee.

$$\text{Up-front Fee Amount (\$)} = \text{Principal Amount (\$)} \times \text{Up-front Fee Percentage (\%)}$$



**Months Prior to Operation**

The loan period for the construction loan in months.

**Annual Interest Rate**

The construction loan interest rate as an annual percentage.

**Principal**

The amount borrowed for each construction period loan:

$$\text{Principal Amount (\$)} = \text{Total Installed Cost (\$)} \times \text{Percent of Installed Costs (\%)}$$

**Interest**

The total interest payment due for each construction period loan, assuming that 100% of the construction balance is outstanding for half of the construction period.

$$\text{Interest (\$)} = \text{Principal Amount (\$)} \times \text{Loan Rate (\%/yr)} \div 12 \text{ (mos/yr)} \times \text{Months prior to operation} \div 2$$

**Total Construction Financing Cost**

The total construction financing cost is part of the project's capital costs included in the [net capital cost](#) value in the Metrics table.

$$\text{Total Construction Financing Cost} = \text{Interest} + \text{Up-front Fee Amount}$$

**Cost of Acquiring Financing**

The Cost of Acquiring Financing input values represent the cost of securing debt or the participation of tax investors. SAM includes the financing cost and development fees in the project's capital cost.

**Financing Cost (Single Owner only)**

The dollar amount associated with acquiring financing.

**Development Fee (All options except Single Owner)**

A fee paid to the developer in Year 0, specified as a percentage of the total installed cost on the [System Costs](#) page.

$$\text{Development Fee (\$)} = \text{Development Fee (\%)} \times \text{Total Installed Cost (\$)}$$

**Equity Closing Cost (All options except Single Owner)**

A dollar amount representing costs associated with securing participation of a tax investor, such as consultants and legal fees.

**Other Financing Costs (All options except Single Owner)**

A dollar amount for financing costs not included in the equity closing cost or development fee.

**Reserve Accounts**

Reserve accounts are funds set aside to cover unexpected costs. Project financial partners may require that the project owner(s) establish and fund reserve accounts. Reserve account funding is a project cost. Interest on reserves contribute to the project's cash flow.

**Interest on Reserves**

Annual interest rate earned on funds in reserve accounts. The different financial models have different reserve accounts, and the interest on reserves rate applies to all of the accounts available for a given option:

- Working capital reserve account, specified under Cost of Acquiring Financing.
- Major equipment reserve account, specified under Major Equipment Replacement Reserves.
- Debt service reserve account (Leveraged Partnership Flip, Single Owner), specified under Debt Service.
- Lessee reserve account (Sale Leaseback), specified under Sale Leaseback.

### Working Capital Reserve Account

The working capital reserve account covers cash flow delays, and is sized in months of operating costs. The account is funded in Year zero, earns interest in Years 1 through the end of the analysis period. Funds are released at the end of the analysis period.

The size of the working capital reserve in months of operation.

$$\text{Working Capital Reserve Amount} = \text{Months of Operating Costs (months)} / 12 \text{ months/yr} \times \text{Year One Total Expenses (\$/yr)}$$

### Debt Service Reserve Account

A debt service reserve account is a fund that may be required by the project debt provider. The account is funded in Year 0 and earns interest in Years 1 and later at the reserve interest rate specified under Reserves. The funds in the account are released at the end of the debt period.

The number of months of principal and interest payments in Year One whose value is equivalent to the size of the debt reserve account in Year 0.

SAM calculates the reserve account size in Year 0 based on the principal and interest amounts in Year One:

$$\text{Year 0 Debt Service Reserve Amount} = ( \text{Year One Principal (\$/yr)} + \text{Year One Interest (\$/yr)} ) \times \text{Debt Service Reserve Account (months)} / 12 \text{ (months/yr)}$$

**Tip.** Debt Service Reserve Accounts for utility-scale projects are typically sized to cover 6 to 12 months of principal and interest payments.

## Major Equipment Replacement Reserve Accounts

Major equipment replacement reserves are funds that the project sets aside to cover the cost of replacing equipment during the analysis period. You can specify up to three replacement reserve accounts.

SAM assumes that the cost of each major equipment replacement is capitalized rather than expensed. You can specify a depreciation schedule for each the major equipment replacement cost.

SAM calculates the inflation-adjusted cost of each major equipment replacement and funds a reserve account in each of the replacement cycle. At the time of each major equipment replacement, funds are released from the reserve account in an amount sufficient to cover the expense.

**Note.** In SAM, equipment replacement reserve funding is separate from operation and maintenance costs that you specify on the [System Costs](#) page.

### Account Name

The name of the reserve account for your reference. SAM reports value associated with each account in the cash flow and other graphs and tables using the name Reserve Account 1, 2, and 3, regardless of the name you enter.

### Replacement Cost

The cost in Year One dollars per kW of nameplate capacity.

$$\text{Replacement Cost (\$)} = \text{Replacement Cost (Year One \$/kW)} \times \text{Nameplate Capacity (kW)}$$

### Replacement Frequency

The frequency in years that the replacement cost occurs.

For example, a replacement cost of \$10,000 and frequency of 5 years results in an inflation-adjusted major equipment capital spending amount of \$10,000 occurring in Years 5, 10, 15, 20, etc.

### Depreciation Treatment For All Capital Expenditure

Specify a federal and state depreciation method for the major equipment replacement cost.

SAM includes major equipment replacement reserves in the annual total depreciation amount in the cash flow.

## 26.9 Sale Leaseback

This topic describes the inputs on the Financial Parameters page for the Sale Leaseback financial model. For a general description of financial structures SAM can model, see [Financial Models](#).

SAM displays results of the financial model in the [cash flow](#). See [Cash Flow Variables](#) for details.

### Solution Mode

The Solution Mode inputs are where you determine how SAM calculates the PPA price, IRR, and other results that appear in the Metrics table on the [Summary](#) page.

The PPA price is the bid price in a power purchase agreement (PPA), and is the price that the project receives for each unit of electricity that the system generates. The internal rate of return (IRR) is a measure of the project's profitability, and is defined as the nominal discount rate that corresponds to a net present value (NPV) of zero.

The solution mode determines whether SAM calculates a PPA price based on an IRR target that you specify, or an IRR based on a PPA price that you specify:

- **Specify IRR Target** allows you to specify the IRR as an input, and SAM uses a search algorithm to find the PPA price required to meet the target IRR.
- **Specify PPA Price** allows you to specify the [PPA price](#) as an input, and SAM calculates the resulting [IRR](#).

#### Solution Mode 1: Specify IRR Target

The Specify IRR Target option allows you to specify an IRR target value and the year that you would like the IRR to be achieved. SAM finds the [PPA price](#) required to meet the target given your assumptions including financial parameters, [incentives](#) and [depreciation](#), and the project's [system costs](#).

SAM uses an iterative algorithm to search for the PPA price that meets the IRR target in the year you specify. If it cannot find a solution, it finds the PPA price that results in an IRR and year as close as possible to the target values.

### IRR target

The desired IRR target as a percentage:

- For the Single Owner model the required IRR is the project IRR.
- For the All Equity and Leveraged Partnership Flip and Sale Leaseback models, the target IRR is the tax investor IRR. SAM calculates the developer IRR as a function of the value in excess of the tax investor IRR.

### IRR target year

The year in which you want the target IRR to be achieved. For the partnership flip options, this is the flip year when project returns switch from the tax investor (pre-flip) to the developer (post-flip).

## Solution Mode 2: Specify PPA Price

The Specify PPA Price option allows you to specify the PPA price. SAM calculates the resulting [IRR](#):

- For the Single Owner model, SAM calculates the project IRR.
- For All Equity and Leveraged Partnership Flip, and Sale Leaseback models that involve two parties, SAM calculates two IRR values: One from the tax investor perspective, and one from the developer perspective. For the partnership flip options, SAM also calculates the flip year when project returns switch from the tax investor to the developer.

### PPA Price

The power price in dollars per kWh. This is the price that would be negotiated as part of a power purchase agreement.

**Note.** Regardless of the solution mode you choose, the PPA price is associated with the annual PPA price escalation rate if it increases from year to year, and the set of multipliers defined on the [Revenue](#) page. Be sure to use the "Uniform Dispatch" option for projects that do not involve time-of-delivery adjustments to the PPA price.

### IRR target year

The year you want to achieve the project IRR that SAM calculates.

## Escalation Rate

An escalation rate applied to the PPA price in Year One to calculate the power purchase price in years two and later in the project cash flow.

SAM does not apply the inflation rate to the PPA price. If you do not specify a PPA price escalation rate, SAM assumes that the same price applies in all years of the analysis period.

## Sale Leaseback

The Sale Leaseback input variables determine the developer's operating margin and size of the lease payment reserve account. SAM includes the developer's margin as a project expense in the [cash flow](#).

### Lessee Operating Margin

The developer's margin in dollars per kilowatt of system nameplate capacity.

### Lessee Margin Escalation

An annual escalation rate that applies to the developer's margin. The inflation rate does not apply to the developer's margin.

**Lessor Required Lease Payment Reserve**

The size of the lease payment reserve account in months. (In some cases, the tax investor may require that the developer fund a reserve account.)

$$\text{Lease Reserve Amount (\$)} = \text{Lessor Required Lease Payment Reserve (months)} / 12 \text{ (months/yr)} \times \text{Year 1 Pre-tax Operating Cash Flow (\$/yr)}$$

The lease reserve amount is one of the fees included in the [net capital cost](#) value reported on the Metrics table, which is included in the issuance of equity value in the [cash flow](#).

**Amount**

This amount of the developer's margin.

$$\text{Amount (\$)} = \text{Lessee Operating Margin (\$/kW)} \times \text{System Nameplate Capacity (kW)}$$

The system nameplate capacity depends on technology being modeled. SAM converts the capacity value to the appropriate units (MW, kW, or W) before using it in calculations. For the photovoltaic models, the capacity is a DC power rating, and for the others it is an AC power rating. For the Solar Water Heating Model, the capacity is a thermal rating, while for the others it is an electric rating.

**Table 9. Nameplate system capacity values for each technology.**

Performance Model	System Capacity	Input Page
Detailed photovoltaic (DC)	Total Array Power (Wdc)	<a href="#">Array</a>
PVWatts (DC)	DC Rating (kWdc)	<a href="#">PVWatts Solar Array</a>
High concentration photovoltaic (DC)	System Nameplate Capacity	<a href="#">Array</a>
CSP Parabolic Trough - Physical (AC)	Estimated Net Output at Design (Nameplate) (MWe)	<a href="#">Power Cycle</a>
CSP Parabolic Trough - Empirical (AC)	Estimated Net Output at Design (MWe)	<a href="#">Power Block</a>
CSP Molten Salt Power Tower (AC)	Estimated Net Output at Design (Nameplate) (MWe)	<a href="#">Power Cycle</a>
CSP Generic Solar (AC)	Estimated Net Output at Design (Nameplate) (MWe)	<a href="#">Power Block</a>
CSP Linear Fresnel (AC)	Net nameplate capacity (MWe)	<a href="#">Power Cycle</a>
Generic System (AC)	Nameplate Capacity (kWe)	<a href="#">Power Plant</a>
Geothermal	Net Plant Output (MWe)	<a href="#">Plant and Equipment</a>
Water Heating Model (Thermal)	Nameplate Capacity (kWt)	<a href="#">SWH System</a>
Wind Power (AC)	System Nameplate Capacity (kWe)	<a href="#">Wind Farm</a>
Biopower (AC)	Nameplate Capacity, Gross (kWe)	<a href="#">Plant Specs</a>

## Analysis Parameters

The analysis parameters specify the analysis period, inflation rate and discount rate.

### Analysis Period

Number of years covered by the analysis. Typically equivalent to the project or investment life. The analysis period determines the number of years in the project [cash flow](#).

### Inflation Rate

Annual rate of change of costs, typically based on a price index, expressed as a percentage. SAM uses the inflation rate to calculate the value of costs in years two and later of the project cash flow based on Year One dollar values that you specify on the [System Costs](#) page, Financial Parameters page, [Electricity Rates](#) page, and [Incentives](#) page.

The default value of 2.5% is based on [consumer price index data from the U.S. Department of Labor Bureau of Labor Statistics](#), and is the average of the annual average consumer price index between 1991 and 2012.

The inflation rate may be either a positive or negative value.

### Real Discount Rate

A measure of the time value of money expressed as an annual percentage. SAM uses the real discount rate to calculate the present value (value in year one) of dollar amounts in the project cash flow over the analysis period and to calculate annualized costs.

SAM's financial model results are very sensitive to the real discount rate input. If you plan to use metrics like the net present value (NPV), levelized cost and PPA price, and internal rate of return, you should carefully consider the discount rate to use for your analysis. The default value is based on a reasonable guess for renewable energy projects in the United States. Because discount rates are very subjective and project developers are typically reluctant to share information about discount rates, published documents on renewable energy finance typically do not include detailed information about discount rates.

**Note.** For projects with one of the PPA financial models, SAM includes both a discount rate and internal rate of return (IRR) in the analysis. For these projects, the discount rate represents the value of an alternative investment, and the IRR can represent a profit requirement or the risk associated with the project. For example, the IRR may be higher than the discount rate for a renewable energy project with higher risk than an alternative investment.

### Nominal Discount Rate

SAM calculates the nominal discount based on the values of the real discount rate and the inflation rate:

$$\text{Nominal Discount Rate} = [ ( 1 + \text{Real Discount Rate} \div 100 ) \times ( 1 + \text{Inflation Rate} \div 100 ) - 1 ] \times 100$$

## Tax and Insurance Rates

### Federal and State Income Tax Rates

The annual federal and state income tax rate applies to taxable income and is used to calculate the project's tax benefits and liabilities.

You can specify either a single annual tax rate, or use the [Edit Schedule](#) window to specify a tax rate for each year. The latter option is useful for modeling a tax holiday where the tax rate for the first few

years is zero.

For all projects, taxable income includes income from any incentives marked on the [Incentives](#) page as taxable.

For residential and commercial projects, SAM does not consider the value of electricity saved by the system to be taxable income. For commercial projects, because those savings represent the value of electricity purchases that would have been a tax-deductible operating expense to the commercial entity, SAM does reduce the project cash flow by the amount of federal and state income tax on the value of the electricity. In other words, with the renewable energy system in place, the commercial entity must pay tax on that portion of its income that it would have deducted as an operating expense.

For PPA projects, taxable income includes earnings before interest, taxes, depreciation and amortization (EBIDTA) and interest earned on reserve accounts. EBIDTA is revenue from electricity sales revenue (PPA revenue) less annual operation and maintenance, property tax, and insurance expenses.

### Sales Tax

The sales tax is a one-time tax that SAM includes in the project's total installed cost. SAM calculates the sales tax amount by multiplying the sales tax rate on the Financial Parameters page by the rate you specify under Indirect Capital Costs and the Total Direct Cost on the [System Costs](#) page.

For tax purposes, because SAM includes the sales tax amount in the total installed cost, it treats sales tax as part of the cost of property. For projects with depreciation (Commercial and PPA financial models only), SAM includes the sales tax amount in the depreciable basis. See IRS Publication 551, Basis of Assets, for more details.

Some states and other jurisdictions offer a sales tax exemption for renewable energy projects. To model a sales tax exemption in SAM, reduce the sales tax percentage as appropriate. For example, for a 100% sales tax exemption, enter a sales tax rate of zero.

For projects with debt, because SAM includes the sales tax amount in the total installed cost, the sales tax influences the debt amount and debt interest payment. For projects where debt interest payments are deductible from federal and state income tax (all financial models except Residential with standard loan), SAM includes sales tax in the calculation of the deductions.

### Insurance Rate (Annual)

SAM treats annual insurance payments as part of the annual operating costs. The insurance cost in year one of the project cash flow is the insurance rate multiplied by the total installed cost from the [System Costs](#) page. The first year cost is then increased by inflation in each subsequent year. For commercial and PPA projects, the insurance cost is a tax-deductible operating expense.

### Property Tax

Property tax is an annual project expense that SAM includes under Operating Expenses in the [cash flow](#).

SAM treats property tax as a tax-deductible operating expense for each year. In each year of the project cash flow, the property tax cost is the property tax rate multiplied by the assessed value for that year.

SAM determines the annual property tax payment by calculating an assessed value for each year in the cash flow, and applying the assessed percent to that value. The assessed value may decline from year to year at the rate you specify. The assessed percent and tax rate both remain constant from year to year.

For residential projects, the property tax amount is the only operating cost that can be deducted from state and federal income tax.

### Assessed Percent

The assessed value of property subject to property taxes as a percentage of the system total installed cost specified on the [System Costs](#) page. SAM uses this value to calculate the assessed property value in year one of the project cash flow.

### Assessed Value

The assessed property value in Year One of the project cash flow:

$$\text{Assessed Value (\$)} = \text{Assessed Percent (\%)} \times \text{Total Installed Cost (\$)}$$

Where Total Installed Cost is from the [System Costs](#) page.

### Assessed Value Decline

The annual decline in the assessed property value. SAM uses this value to calculate the property assessed value in years two and later of the project cash flow. For an assessed value that does not decrease annually, specify a value of zero percent per year.

### Property Tax

The annual property tax rate applies to the assessed value of the project in each year of the project cash flow.

## Salvage Value

SAM considers the salvage value to be project income in the final year of the project cash flow, and calculates the value as a percentage of the total installed cost from the [System Costs](#) page.

For example, if you specify a 10% salvage value for a project with a 30-year analysis period, and total installed cost of \$1 million, SAM includes income in Year 30 of  $\$100,000 = \$1,000,000 \times 0.10$ .

For residential projects, the salvage value has no effect on federal and state income tax.

For commercial and PPA projects, the salvage value is treated as a source of pre-tax revenue in the final year of the analysis period, increasing the federal and state taxable income.

### Net Salvage Value

The salvage value as a percentage of the project's total installed cost from the [System Costs](#) page.

### End of Analysis Period Salvage Value

The salvage value dollar amount that will appear in final year of the project [cash flow](#).

$$\text{End of Analysis Period Salvage Value (\$)} = \text{Net Salvage Value (\%)} \times \text{Total Installed Cost (\$)}$$

Where *Total Installed Cost* is from the [System Costs](#) page.

## Construction Financing

SAM allows you to specify parameters for up to five construction loans to approximate interest during construction (IDC) that SAM considers to be a cost to the project.

SAM assumes that 100% of the construction balance is outstanding for half of the construction period, which is equivalent to an even monthly draw schedule with an average loan life of half of the construction period. To approximate a different draw schedule, you could adjust the loan's interest rate accordingly.

**Note.** To model a project with no construction period loans, set the **Percent of Installed Costs** value for each of the five loans to zero.



The construction financing cost is part of the project's [net capital cost](#). SAM includes the construction financing cost in the basis for calculating the basis for depreciation and the investment tax credit (ITC).

### Construction Loans

SAM allows you to specify up to five construction loans. You can type a name describing each loan or use the default names.

### Percent of Installed Costs

The amount borrowed for the construction loan as a percentage of the total installed cost, assuming that all construction costs are included in the installation costs you specify on the System Costs page. Specify a non-zero percentage for each construction period loan you want to include in the analysis.

The sum of the up to five percentage values you specify for each construction loan must be 100%.

### Up-front Fee

A percentage of the principal amount, typically between 1% and 3% that SAM adds to the interest amount for each construction loan to calculate the total construction financing cost. Note that no interest applies to the up-front fee.

$$\text{Up-front Fee Amount (\$)} = \text{Principal Amount (\$)} \times \text{Up-front Fee Percentage (\%)}$$

### Months Prior to Operation

The loan period for the construction loan in months.

### Annual Interest Rate

The construction loan interest rate as an annual percentage.

### Principal

The amount borrowed for each construction period loan:

$$\text{Principal Amount (\$)} = \text{Total Installed Cost (\$)} \times \text{Percent of Installed Costs (\%)}$$

### Interest

The total interest payment due for each construction period loan, assuming that 100% of the construction balance is outstanding for half of the construction period.

$$\text{Interest (\$)} = \text{Principal Amount (\$)} \times \text{Loan Rate (\%/yr)} \div 12 \text{ (mos/yr)} \times \text{Months prior to operation} \div 2$$

### Total Construction Financing Cost

The total construction financing cost is part of the project's capital costs included in the [net capital cost](#) value in the Metrics table.

$$\text{Total Construction Financing Cost} = \text{Interest} + \text{Up-front Fee Amount}$$

## Cost of Acquiring Financing

The Cost of Acquiring Financing input values represent the cost of securing debt or the participation of tax investors. SAM includes the financing cost and development fees in the project's capital cost.

### Financing Cost (Single Owner only)

The dollar amount associated with acquiring financing.

### Development Fee (All options except Single Owner)

A fee paid to the developer in Year 0, specified as a percentage of the total installed cost on the [System Costs](#) page.

$$\text{Development Fee (\$)} = \text{Development Fee (\%)} \times \text{Total Installed Cost (\$)}$$

### Equity Closing Cost (All options except Single Owner)

A dollar amount representing costs associated with securing participation of a tax investor, such as consultants and legal fees.

### Other Financing Costs (All options except Single Owner)

A dollar amount for financing costs not included in the equity closing cost or development fee.

## Reserve Accounts

Reserve accounts are funds set aside to cover unexpected costs. Project financial partners may require that the project owner(s) establish and fund reserve accounts. Reserve account funding is a project cost. Interest on reserves contribute to the project's cash flow.

### Interest on Reserves

Annual interest rate earned on funds in reserve accounts. The different financial models have different reserve accounts, and the interest on reserves rate applies to all of the accounts available for a given option:

- Working capital reserve account, specified under Cost of Acquiring Financing.
- Major equipment reserve account, specified under Major Equipment Replacement Reserves.
- Debt service reserve account (Leveraged Partnership Flip, Single Owner), specified under Debt Service.
- Lessee reserve account (Sale Leaseback), specified under Sale Leaseback.

### Working Capital Reserve Account

The working capital reserve account covers cash flow delays, and is sized in months of operating costs. The account is funded in Year zero, earns interest in Years 1 through the end of the analysis period. Funds are released at the end of the analysis period.

The size of the working capital reserve in months of operation.

$$\text{Working Capital Reserve Amount} = \text{Months of Operating Costs (months)} / 12 \text{ months/yr} \times \text{Year One Total Expenses (\$/yr)}$$

### Debt Service Reserve Account

A debt service reserve account is a fund that may be required by the project debt provider. The account is funded in Year 0 and earns interest in Years 1 and later at the reserve interest rate specified under Reserves. The funds in the account are released at the end of the debt period.

The number of months of principal and interest payments in Year One whose value is equivalent to the size of the debt reserve account in Year 0.

SAM calculates the reserve account size in Year 0 based on the principal and interest amounts in Year One:

$$\text{Year 0 Debt Service Reserve Amount} = (\text{Year One Principal (\$/yr)} + \text{Year One Interest (\$/yr)}) \times \text{Debt Service Reserve Account (months)} / 12 \text{ (months/yr)}$$

**Tip.** Debt Service Reserve Accounts for utility-scale projects are typically sized to cover 6 to 12 months of principal and interest payments.

## Major Equipment Replacement Reserve Accounts

Major equipment replacement reserves are funds that the project sets aside to cover the cost of replacing equipment during the analysis period. You can specify up to three replacement reserve accounts.

SAM assumes that the cost of each major equipment replacement is capitalized rather than expensed. You can specify a depreciation schedule for each the major equipment replacement cost.

SAM calculates the inflation-adjusted cost of each major equipment replacement and funds a reserve account in each of the replacement cycle. At the time of each major equipment replacement, funds are released from the reserve account in an amount sufficient to cover the expense.

**Note.** In SAM, equipment replacement reserve funding is separate from operation and maintenance costs that you specify on the [System Costs](#) page.

#### **Account Name**

The name of the reserve account for your reference. SAM reports value associated with each account in the cash flow and other graphs and tables using the name Reserve Account 1, 2, and 3, regardless of the name you enter.

#### **Replacement Cost**

The cost in Year One dollars per kW of nameplate capacity.

$$\text{Replacement Cost (\$)} = \text{Replacement Cost (Year One \$/kW)} \times \text{Nameplate Capacity (kW)}$$

#### **Replacement Frequency**

The frequency in years that the replacement cost occurs.

For example, a replacement cost of \$10,000 and frequency of 5 years results in an inflation-adjusted major equipment capital spending amount of \$10,000 occurring in Years 5, 10, 15, 20, etc.

#### **Depreciation Treatment For All Capital Expenditure**

Specify a federal and state depreciation method for the major equipment replacement cost.

SAM includes major equipment replacement reserves in the annual total depreciation amount in the cash flow.

## **26.1 LCOE Calculator**

### **0**

The LCOE Calculator uses a simple method to calculate a project's levelized cost of energy (LCOE) using only the following inputs:

- Capital cost, \$ (TCC), or installed capital costs.
- Fixed annual operating cost, \$ (FOC), or operations and maintenance costs.
- Variable operating cost, \$/kWh (VOC), or operations and maintenance costs per unit of annual electricity production.
- Fixed charge rate (FCR)
- Annual electricity production, kWh (AEP)

The LCOE Calculator uses the following equation to calculate the LCOE:

$$\text{LCOE} = \frac{\text{FCR} \times \text{TCC} + \text{FOC}}{\text{AEP}} + \text{VOC}$$

The fixed charge rate is the revenue per amount of investment required to cover the investment cost. For details, see pp. 22-24 of Short W et al, 1995. *Manual for the Economic Evaluation of Energy Efficiency and Renewable Energy Technologies*. National Renewable Energy Laboratory. NREL/TP-462-5173. ([PDF 6.6 MB](#))

This method is an alternative to the cash flow method used by SAM's other financial models. It is appropriate for very preliminary stages of project feasibility analysis before you have many details about the project's costs and financial structure. It also useful for large-scale studies of market trends, such as those used for the NREL [Annual Technology Baseline \(ATB\)](#) study.

## Capital and Operating Costs

You can enter the capital and fixed operating cost either as dollar amounts or in dollars per kilowatt of system capacity.

**Note.** For the marine energy models, enter the capital and operating costs on the Capital Costs pages. SAM calculates the total capital cost and operating cost from the values on the Capital Costs pages.

### System capacity

The renewable energy system's nameplate capacity. Its value depends on the performance model you use for the simulation, and is shown here for reference when you enter costs in \$/kW.

### Enter costs in \$

Choose this option to enter the capital cost and annual fixed operating costs as dollar amounts. Not available for marine energy models.

### Enter costs in \$/kW

Choose this option to enter the capital cost and annual fixed operating costs in dollars per kilowatt of system capacity. The system capacity depends on the performance model you choose. Not available for marine energy models.

### Capital cost

The project's total investment cost, or installed capital costs. For the marine energy models, this is the sum of the costs on the Capital Costs pages.

### Fixed operating cost

Annual operating and maintenance costs that do not vary with the amount of electricity the system generates. For the marine energy models, this is the sum of the costs on the Capital Costs pages.

### Variable operating cost

Annual operating and maintenance costs in dollars per kilowatt-hour that vary with the amount of electricity the system generates.

## Summary

The Summary values are the inputs to the LCOE equation shown above. SAM calculates these values from the inputs you specify. You cannot edit these values directly.

**Fixed charge rate**

The project fixed charge rate is an annual return as a fraction of the capital cost, or revenue per amount of investment required to cover the investment cost. It is either the value you enter under **Financial Assumptions**, or the value SAM calculates from the financial details you enter.

**Capital cost**

The total investment cost in dollars. It is either the value you entered or a value that SAM calculates based on the value you enter in dollars per kilowatt.

**Fixed operating cost**

The fixed annual operating cost in dollars. It is either the value you enter or a value that SAM calculates based on the value you enter in dollars per kilowatt.

**Variable operating cost**

The variable annual operating cost in dollars per kilowatt-hour that you enter.

**Financial Assumptions**

The fixed charge rate represents details of the project's financial structure. You can either enter the value directly, or enter project financial details and SAM calculates the value.

**Enter fixed charge rate**

Choose this option to enter the fixed charge rate.

**Calculate fixed charge rate**

Choose this option to have SAM calculate the fixed charge rate from a set of financial assumptions. The SAM uses the following equation to calculate the value from the capital recovery factor, project financing factor, and construction financing factor (see below for all equations):

$$FCR = CRF \times PFF \times CFF$$

**Fixed charge rate**

The project's fixed charge rate. Note that the value is a factor (between 0 and 1) rather than a percentage.

**Analysis period**

The number of years that the project will generate electricity and earn revenue.

**Inflation rate**

The annual inflation rate over the analysis period. To exclude inflation from the analysis, set the inflation rate to zero.

**Internal rate of return**

The project's annual nominal rate of return on equity requirement.

**Project term debt**

The size of debt as a percentage of the capital cost.

**Nominal debt interest rate**

The annual nominal debt interest rate. SAM assumes that the debt period is the same as the analysis period.

**Effective tax rate**

The total income tax rate. For a project that pays both federal and state income taxes, where the state income tax is deducted from the federal tax, you can calculate the effective tax rate as:

$$\text{TAX} = \text{STATE} + \text{FED} \times (1 - \text{STATE})$$

To exclude income tax from the analysis, set the effective tax rate to zero.

**Depreciation schedule**

The annual depreciation schedule. The depreciation basis equals the project's capital cost.

To enter a depreciation schedule, click the small blue and grey button next to the **Edit** button so that the button becomes active. Then click **Edit** to open the Edit Schedule window. In the Edit Schedule window, for **Number of values**, enter the number of years in the depreciation schedule, and then enter the depreciation percentage for each year in the Value table.

For MACRS 5-yr depreciation the table should look like this:

	Value	Number of values:
1	20	6
2	32	
3	19.2	
4	11.52	
5	11.52	
6	5.76	

To exclude depreciation from the analysis, set the depreciation percentage(s) to zero.

**Annual cost during construction**

The annual construction cost as a percentage of the project's capital cost. If the construction period is one year or less, enter a single value. If it is more than one year, enter a schedule of annual percentages.

To enter a construction cost schedule, click the small blue and grey button next to the **Edit** button so that the button becomes active. Then click **Edit** to open the Edit Schedule window. For **Number of values**, enter the number of years in the construction period, and then enter a cost (as a percentage of the capital cost) for each year in the Value table.

To exclude construction financing costs from the analysis, set the annual cost during construction to 100%, and the nominal construction interest rate to zero.

**Nominal construction interest rate**

The annual interest rate on construction financing.

**Capital recovery factor (CRF)**

SAM calculates this value from the inputs you specify as described below.

**Project financing factor (PFF)**

Factor to account for project financing costs. SAM calculates this value from the effective tax rate and depreciation schedule, as described below.

A value of "NaN" (not a number) indicates that the effective tax rate is 100%. Change the tax rate to something less than 100% to correct the problem.

**Construction financing factor (CFF)**

Factor to account for construction financing costs. SAM calculates the value from the construction cost schedule, effective tax rate, and construction interest rate, as described below.

A value of zero will cause the FCR to be zero, and is caused by setting the annual cost during construction to zero. If you want to exclude construction financing (CFF = 1), you should set the annual cost during construction to 100%, and the nominal construction interest rate to zero.

**Equations for FCR Calculation**

When you use the **Calculate fixed charge rate** option, SAM uses the following equations to calculate the financing factors.

**Nomenclature**

c = Construction year

C = Construction period in years

CON = Construction schedule

DF = Project term debt fraction

i = Inflation rate

n = Analysis year

N = Analysis period

IRR = Nominal return on investment

NINT = Nominal debt interest rate

PVDEP = Present value of depreciation

RINT = Real debt interest rate

RROE = Real return on investment

TAX = Effective tax rate

WACC = Weighted average cost of capital (real)

The capital recovery factor (CRF) is a function of the weighted average cost of capital (WACC) and analysis period (N):

$$CRF = \frac{WACC}{1 - \frac{1}{(1+WACC)^N}}$$

Where:

$$WACC = \frac{1 + \left( (1-DF) \times ((1+RROE) \times (1+i) - 1) \right) + DF \times ((1+RINT) \times (1+i) - 1) \times (1-TAX)}{1+i} - 1$$

$$RROE = \frac{1 + IRR}{1 + i} - 1$$

$$RINT = \frac{1 + NINT}{1 + i} - 1$$

The project financing factor (PFF) is a function of the effective tax rate and depreciation schedule:

$$PFF = \frac{1 - (TAX \times PVDEP)}{1 - TAX}$$

Where:

$$PVDEP = \sum_{n=0}^N \frac{DEP_n}{((1+WACC) \times (1+i))^{(n+1)}}$$

The construction financing factor (CFF) is a function of the construction cost schedule, effective tax rate, and nominal construction financing interest rate:

$$CFF = \sum_{c=0}^C CON_c \times (1 + (1-TAX) \times ((1+CINT)^{(c+0.5)} - 1))$$

## 27 Revenue

The Revenue page is where provide information about power prices for the project's revenue streams.

For the [PPA Single Owner](#) financial model, potential sources of revenue include:

- PPA revenue from electricity sales
- Capacity payments (optional)
- Curtailment payments (optional)

For the [Merchant Plant](#) model, revenue may include:

- Revenue from electricity sales at market prices
- Revenue from ancillary services
- Revenue from capacity payments

### 27.1 Power Purchase Agreement

The Revenue page for the PPA models provide inputs to define the power price, TOD factors, and capacity payments that determine the project's revenue. If you are modeling a merchant plant project with power prices at market rates, [choose](#) the Merchant Plant [financial model](#) instead of the PPA Single Owner model.

**Note.** For the PPA Partnership Flip and Sale Leaseback financial models, the PPA revenue inputs are on the [Financial Parameters](#) page.



To see the project revenue after a simulation, go to the [Cash Flow](#) tab on the results page. You can also see the revenue data on the [Data Tables](#) tab by filtering the table for variables with "revenue" in the variable name.

## Solution Mode

The Solution Mode inputs are where you determine how SAM calculates the PPA price, IRR, and other results that appear in the Metrics table on the [Summary](#) page.

The PPA price is the bid price in a power purchase agreement (PPA), and is the price that the project receives for each unit of electricity that the system generates. The internal rate of return (IRR) is a measure of the project's profitability, and is defined as the nominal discount rate that corresponds to a net present value (NPV) of zero.

The solution mode determines whether SAM calculates a PPA price based on an IRR target that you specify, or an IRR based on a PPA price that you specify:

- **Specify IRR Target** allows you to specify the IRR as an input, and SAM uses a search algorithm to find the PPA price required to meet the target IRR.
- **Specify PPA Price** allows you to specify the [PPA price](#) as an input, and SAM calculates the resulting [IRR](#).

### Solution Mode 1: Specify IRR Target

The Specify IRR Target option allows you to specify an IRR target value and the year that you would like the IRR to be achieved. SAM finds the [PPA price](#) required to meet the target given your assumptions including financial parameters, [incentives](#) and [depreciation](#), and the project's [system costs](#).

SAM uses an iterative algorithm to search for the PPA price that meets the IRR target in the year you specify. If it cannot find a solution, it finds the PPA price that results in an IRR and year as close as possible to the target values.

#### IRR target

The desired IRR target as a percentage:

- For the Single Owner model the required IRR is the project IRR.
- For the All Equity and Leveraged Partnership Flip and Sale Leaseback models, the target IRR is the tax investor IRR. SAM calculates the developer IRR as a function of the value in excess of the tax investor IRR.

#### IRR target year

The year in which you want the target IRR to be achieved. For the partnership flip options, this is the flip year when project returns switch from the tax investor (pre-flip) to the developer (post-flip).

### Solution Mode 2: Specify PPA Price

The Specify PPA Price option allows you to specify the PPA price. SAM calculates the resulting [IRR](#):

- For the Single Owner model, SAM calculates the project IRR.
- For All Equity and Leveraged Partnership Flip, and Sale Leaseback models that involve two parties, SAM calculates two IRR values: One from the tax investor perspective, and one from the developer perspective. For the partnership flip options, SAM also calculates the flip year when project returns switch from the tax investor to the developer.

### PPA Price

The power price in dollars per kWh. This is the price that would be negotiated as part of a power purchase agreement.

**Note.** Regardless of the solution mode you choose, the PPA price is associated with the annual PPA price escalation rate if it increases from year to year, and the set of multipliers defined on the [Revenue](#) page. Be sure to use the "Uniform Dispatch" option for projects that do not involve time-of-delivery adjustments to the PPA price.

### IRR target year

The year you want to achieve the project IRR that SAM calculates.

### Escalation Rate

An escalation rate applied to the PPA price in Year One to calculate the power purchase price in years two and later in the project cash flow.

SAM does not apply the inflation rate to the PPA price. If you do not specify a PPA price escalation rate, SAM assumes that the same price applies in all years of the analysis period.

### Time of Delivery

Power generation projects sell all of the electricity that the system generates at a price negotiated through a power purchase agreement (PPA). For these projects, SAM allows you to define time-of-delivery (TOD) factors, or multipliers, to adjust the power price in any given hour of the year. TOD factors are not available for the residential and commercial financial models.

There are two ways to define TOD factors:

#### TOD factors by schedule

Use this option to define the factors using up to nine TOD periods with hour-by-month weekday and weekend schedule matrices, or to choose TOD schedules from a library of data for California.

#### TOD factors by time step

Use this option to assign a TOD factor to each simulation time step. For example, if you are running hourly simulations, you can assign a different TOD factor to each hour of the year.

SAM calculates the PPA price for each hour by multiplying the Year 1 [PPA price](#) shown in the results Summary page by the TOD factors you define for each of up to nine periods.

#### Important Notes!

If your analysis is for a project with a fixed PPA price that does not vary with time of day or month of year, use the **TOD Factor by Schedule** option, select **Uniform Dispatch** in the library and click **Apply values from library** to ensure that all of the PPA multiplier values are set to one.

When you click **Apply values from library**, SAM replaces the TOD data with data from the library. If you are using your own TOD data, you can use the **Save data to file** button at the bottom of the Time of Delivery Factors page to save your data.

#### To populate values from the library:

1. Choose **TOD factors by schedule**.

2. Click a row in the library.
3. Click **Apply values from library**.

**To specify your own TOD factors by schedule:**

1. Choose **TOD factors by schedule**.
2. Type a PPA price multiplier value for up to nine periods.
3. Use the schedule matrices to define the hour and month for each period as described below.

**To specify your own TOD factors by time step**

1. Choose TOD factors by time step.
2. Click **Edit data** and enter your TOD factors in the table.

**About TOD Factors by Schedule****TOD factors**

For each of the nine periods in the list, to calculate the PPA price in a given period, SAM multiplies the Year 1 PPA price by the multiplier you specify. For example, if Period 1 is the summer peak, defined as Noon to 7 p.m. in June through September with a multiplier of 2.38, and the Year PPA price is 6 cents/kWh, the price that the project would receive for each unit of electricity it generates during those summer peak hours would be  $6 \text{ cents/kWh} \times 2.38 = 14.28 \text{ cents/kWh}$ .

**Weekday Schedule, Weekend Schedule**

The weekday and weekend matrices allow you to associate each of the nine periods with a time of day and month of year. To use the matrices, you draw rectangles on the matrix with your mouse, and type a number with your keyboard for the period that applies to the times represented by the rectangles.

SAM arbitrarily defines the first day of time series data (the first 24 hours for hourly data) to be Monday on January 1, and assigns the remaining days of the year accordingly. SAM assumes that weekdays include Monday through Friday, and that weekends include Saturday and Sunday. SAM does not account for holidays or other special days. It also does not account for leap years, and does not include a day for February 29.

**To specify a weekday or weekend schedule:**

1. Assign values as appropriate to each of the up to nine periods.
2. Use your mouse to draw a rectangle in the matrix for the first block of time that applies to period 2.

	12am	1am	2am	3am	4am	5am	6am	7am	8am	9am	10am	11am	12pm	1pm	2pm	3pm	4pm	5pm	6pm	7pm	8pm	9pm	10pm	11pm
Jan	1	1	1	1	1	1	1	1	1	1	1	1	1	1	1	1	1	1	1	1	1	1	1	1
Feb	1	1	1	1	1	1	1	1	1	1	1	1	1	1	1	1	1	1	1	1	1	1	1	1
Mar	1	1	1	1	1	1	1	1	1	1	1	1	1	1	1	1	1	1	1	1	1	1	1	1
Apr	1	1	1	1	1	1	1	1	1	1	1	1	1	1	1	1	1	1	1	1	1	1	1	1
May	1	1	1	1	1	1	1	1	1	1	1	1	1	1	1	1	1	1	1	1	1	1	1	1
Jun	1	1	1	1	1	1	1	1	1	1	1	1	1	1	1	1	1	1	1	1	1	1	1	1
Jul	1	1	1	1	1	1	1	1	1	1	1	1	1	1	1	1	1	1	1	1	1	1	1	1
Aug	1	1	1	1	1	1	1	1	1	1	1	1	1	1	1	1	1	1	1	1	1	1	1	1
Sep	1	1	1	1	1	1	1	1	1	1	1	1	1	1	1	1	1	1	1	1	1	1	1	1
Oct	1	1	1	1	1	1	1	1	1	1	1	1	1	1	1	1	1	1	1	1	1	1	1	1
Nov	1	1	1	1	1	1	1	1	1	1	1	1	1	1	1	1	1	1	1	1	1	1	1	1
Dec	1	1	1	1	1	1	1	1	1	1	1	1	1	1	1	1	1	1	1	1	1	1	1	1

3. Type the number 2.

	12am	1am	2am	3am	4am	5am	6am	7am	8am	9am	10am	11am	12pm	1pm	2pm	3pm	4pm	5pm	6pm	7pm	8pm	9pm	10pm	11pm
Jan	1	1	1	1	1	1	1	1	1	1	1	1	1	1	1	1	1	1	1	1	1	1	1	1
Feb	1	1	1	1	1	1	1	1	1	1	1	1	1	1	1	1	1	1	1	1	1	1	1	1
Mar	1	1	1	1	1	1	1	1	1	1	1	1	1	1	1	1	1	1	1	1	1	1	1	1
Apr	1	1	1	1	1	1	1	1	1	1	1	1	1	1	1	1	1	1	1	1	1	1	1	1
May	1	1	1	1	1	1	1	1	1	1	2	2	2	2	2	2	1	1	1	1	1	1	1	1
Jun	1	1	1	1	1	1	1	1	1	1	2	2	2	2	2	2	1	1	1	1	1	1	1	1
Jul	1	1	1	1	1	1	1	1	1	1	2	2	2	2	2	2	1	1	1	1	1	1	1	1
Aug	1	1	1	1	1	1	1	1	1	1	2	2	2	2	2	2	1	1	1	1	1	1	1	1
Sep	1	1	1	1	1	1	1	1	1	1	1	1	1	1	1	1	1	1	1	1	1	1	1	1
Oct	1	1	1	1	1	1	1	1	1	1	1	1	1	1	1	1	1	1	1	1	1	1	1	1
Nov	1	1	1	1	1	1	1	1	1	1	1	1	1	1	1	1	1	1	1	1	1	1	1	1
Dec	1	1	1	1	1	1	1	1	1	1	1	1	1	1	1	1	1	1	1	1	1	1	1	1

4. SAM shades displays the period number in the squares that make up the rectangle, and shades the rectangle to match the color of the period.

Payment Allocation Factor

Period 1:

Period 2:

Period 3:

Period 4:

**Weekday Schedule**

	12am	1am	2am	3am	4am	5am	6am	7am	8am	9am	10am	11am	12pm	1pm	2pm	3pm	4pm	5pm	6pm	7pm	8pm	9pm	10pm	11pm
Jan	1	1	1	1	1	1	1	1	1	1	1	1	1	1	1	1	1	1	1	1	1	1	1	1
Feb	1	1	1	1	1	1	1	1	1	1	1	1	1	1	1	1	1	1	1	1	1	1	1	1
Mar	1	1	1	1	1	1	1	1	1	1	1	1	1	1	1	1	1	1	1	1	1	1	1	1
Apr	1	1	1	1	1	1	1	1	1	1	1	1	1	1	1	1	1	1	1	1	1	1	1	1
May	1	1	1	1	1	1	1	1	1	1	2	2	2	2	2	2	1	1	1	1	1	1	1	1
Jun	1	1	1	1	1	1	1	1	1	1	2	2	2	2	2	2	1	1	1	1	1	1	1	1
Jul	1	1	1	1	1	1	1	1	1	1	2	2	2	2	2	2	1	1	1	1	1	1	1	1
Aug	1	1	1	1	1	1	1	1	1	1	2	2	2	2	2	2	1	1	1	1	1	1	1	1
Sep	1	1	1	1	1	1	1	1	1	1	1	1	1	1	1	1	1	1	1	1	1	1	1	1
Oct	1	1	1	1	1	1	1	1	1	1	1	1	1	1	1	1	1	1	1	1	1	1	1	1
Nov	1	1	1	1	1	1	1	1	1	1	1	1	1	1	1	1	1	1	1	1	1	1	1	1
Dec	1	1	1	1	1	1	1	1	1	1	1	1	1	1	1	1	1	1	1	1	1	1	1	1

**Weekend Schedule**

	12am	1am	2am	3am	4am	5am	6am	7am	8am	9am	10am	11am	12pm	1pm	2pm	3pm	4pm	5pm	6pm	7pm	8pm	9pm	10pm	11pm	
	E												E	E	E									E	E

5. Repeat Steps 2-4 for each of the remaining periods that apply to the schedule.

### About the TOD Schedules and Factors Library

The TOD Schedules and Factors library stores TOD data for three California electric utilities. For projects outside of California, you can specify your own TOD data.

For the 2015 and 2016 data in the library, the factors are from the following California Public Utilities Commission Advice Letters:

- PG&E 2016: [Advice Letter 4780-E](#) (January 22, 2016)
- SCE 2015: [Advice Letter 3244-E](#) (August 6, 2015)
- SDG&E 2015: [Advice Letter 2717-E](#) Attachment A (July 13, 2015)

**Important Note about California TOD Data!** PG&E and SDG&E offer different TOD options for projects that meet "energy only" or "full capacity deliverability" requirements, and SDG&E has options for "local" and "system" projects. Use your interconnection application and other documents to determine which TOD factors are appropriate for your project so you can choose the correct option in SAM.

For the 2009 and 2011 data, the factors are from the Market Price Referent (MPR) documents available on the [California Public Utilities Commission website](#). The SAM library includes values from Appendix B of Resolution E-4442 (2011) and Resolution E-4298 (2009).

The library is stored as a CSV file in the libraries folder of your SAM installation. For details about how to access the file, see [Libraries](#).

### Time of Delivery Factors in Results

SAM reports hourly, monthly, and annual TOD-related results. You can view these results on the [Data](#) and [Graphs](#) pages.

### Single Values

The single value results are available .

**First year energy from the system in TOD period  $n$** 

The total quantity of electricity delivered to the grid (and sold) by the system in Year one for each of the nine TOD periods, in kWh per year.

**First year energy price for TOD period  $n$** 

The power price for each of the nine TOD periods, equal to the product of the TOD factor for each period and the PPA price shown in the [Metrics table](#).

**First year revenue from the system in TOD period  $n$** 

The dollar value of electricity sold by the project in Year one for each of the nine TOD periods, in dollars per year.

**Monthly Data**

The monthly variables are available on the Results page in [Graphs](#) and [Tables](#).

**First year energy from the system by month for TOD period  $n$** 

The total quantity of electricity delivered to the grid (and sold) by the system in Year one for the given TOD period in each month, in kWh.

**First year revenue from the system by month for TOD period  $n$** 

Total dollar value of electricity sold by the project in Year one for each month.

**Annual Data (All Years)**

**Note.** The first row in the annual data table is equivalent to Year zero in the project [cash flow](#), before the system starts generating electricity.

**Energy produced by the system in TOD period  $n$** 

The total amount of electricity delivered to the grid (and sold) by the system in each year of the analysis period for each of the nine TOD periods.

**Revenue from the system in TOD period  $n$** 

The total dollar value of electricity sold by project in each year of the analysis period for each of the nine TOD periods.

**Capacity Payments**

Capacity payments are is an annual payment to the project for available capacity. SAM reports the annual capacity payment revenue in the project [cash flow](#).

**Capacity Payment Type**

You can specify the capacity payment in dollars per megawatt of eligible capacity, or as a fixed dollar amount.

**Capacity basis**

Choose capacity basis to specify the annual capacity payment as a dollar per megawatt value with the capacity credit specified as a percentage of the system nameplate capacity.

### Fixed amount

Choose fixed amount to specify the annual capacity payment as a dollar amount.

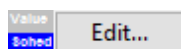
### Capacity payment amount, \$/MW or \$/year

When you choose the capacity basis option, enter a \$/MW value in Year 1 dollars for the annual capacity payment.

**Note.** SAM assumes the capacity payment rate in \$/MW is an annual rate. If you are given a daily or monthly rate, you should convert it to an annual rate. For example, a \$100/MW daily rate would be equivalent to \$36,500/MW annually. Similarly, a \$100/MW monthly rate would be \$1,200/MW annually.

When you choose the fixed amount, enter a \$ value in Year 1 dollars for the annual capacity payment.

You can also click **Sched** and **Edit** to use the [Edit Schedule](#) window to enter a different payment amount for each year of the analysis period instead of a single value.



### Capacity payment escalation

The annual escalation rate applies to the annual capacity payment in Years 2 and later. If you expect the capacity payment amount to increase from year to year, enter the escalation rate as an annual percentage.

The capacity payment escalation rate is disabled when you choose the Schedule option to enter annual values for the capacity payment amount.

### Capacity credit (eligible % of nameplate), %

The percentage of the system's nameplate capacity that is eligible for capacity payments when you choose the **Capacity basis** option.

### System nameplate, MW

The system's nameplate capacity. Note that the nameplate capacity is defined differently for different kinds of systems. For example for photovoltaic systems, the nameplate capacity is the total DC array capacity, and for wind and concentrating solar power systems, it is an AC capacity.

### Battery nameplate, MW

The battery nameplate capacity from the Battery Storage page. SAM shows the battery capacity for reference, but does not include it in the capacity credit value. If your system includes batteries, you can adjust the capacity credit accordingly.

**Note.** The battery nameplate capacity is zero for systems with no batteries.

## Curtailment Payments

Curtailment payments generate revenue in addition to energy payment or PPA revenue during times when the project is required to reduce or stop electricity generation by the electricity off-taker.

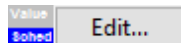
Use the grid curtailment inputs on the [Grid Limits](#) page to define the curtailment schedule.

## Curtailment Compensation

### Curtailed energy compensation, \$/kWh

The compensation rate in dollars per kWh of curtailed energy.

You can specify a single compensation rate as a Year 1 value with optional escalation rate, or click **Sched** and **Edit** to specify a compensation rate for each year using the [Edit Schedule](#) window.



For each hourly or subhourly time step, the curtailed energy is the system's power output minus the curtailment limit from the curtailment table on the [Grid Limits](#) page. The annual curtailed energy is the sum of the hourly or subhourly curtailed power values over one year. SAM shows the annual curtailed energy amount for each year in the project [cash flow](#).

### Curtailed compensation escalation, %/year

The curtailment compensation escalation rate applies to the curtailment revenue in Years 2 and later when you specify the compensation rate as a single Year 1 value. SAM does not apply the inflation rate from the Financial Parameters page to the curtailment compensation rate.

## 27.2 Merchant Plant

The Revenue page provides inputs to define the sources of revenue for the merchant plant. A merchant plant can earn revenue for energy and ancillary services and from capacity payments. SAM calculates reports the annual revenue for each type of service in the project [cash flow](#).

For energy and ancillary services, you can specify cleared capacity and price values for the following time scales over the entire analysis period:

- Single Value: The same cleared capacity (MW) and price (\$/MWh) applies over the entire analysis period.
- Monthly: Cleared capacity and price values change from month to month.
- Daily: Values change from day to day.
- Hourly: Values change hourly.
- Subhourly: As long as you use a weather file with the same time step as the pricing time scale, values apply to each simulation time step (30, 20, 15, 10, 5, or 1-minute time steps are allowed).

Annual revenue from capacity payments can be calculated as a fixed price or a price per unit of eligible capacity with an optional annual capacity payment escalation rate.

### Energy Market Revenue

Energy market revenue is revenue for capacity available in each time step at the specified price in \$/MWh. The cleared capacity is the portion of the generated capacity in a given time step that is compensated at the energy price.

#### Enable energy market revenue

Check the box and click **Edit time series data** to enter cleared capacity and price data over the time scale. You can either enter the data by hand, copy and paste it from your computer's clipboard, or import it from a properly formatted text file. See [Edit Lifetime Data](#) for detailed instructions.



## Ancillary Service Market Revenue

Ancillary service market revenue is revenue for capacity remaining after energy cleared capacity for up to four ancillary services.

**Note.** SAM assumes that the system is able to provide the type of service represented by each ancillary service. It does not model reactive power, frequency, spinning reserves or startup capabilities that would be required to provide these services.

### Enable ancillary service #*n*

For each of up to four ancillary services, check the box and click **Edit time series data** to enter cleared capacity and price data over the time scale. You can either enter the data by hand, copy and paste it from your computer's clipboard, or import it from a properly formatted text file. See [Edit Time Series Data](#) for detailed instructions.

## Capacity Payment Revenue

Capacity payments are is an annual payment to the project for available capacity. SAM reports the annual capacity payment revenue in the project [cash flow](#).

### Capacity Payment Type

You can specify the capacity payment in dollars per megawatt of eligible capacity, or as a fixed dollar amount.

#### Capacity basis

Choose capacity basis to specify the annual capacity payment as a dollar per megawatt value with the capacity credit specified as a percentage of the system nameplate capacity.

#### Fixed amount

Choose fixed amount to specify the annual capacity payment as a dollar amount.

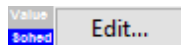
#### Capacity payment amount, \$/MW or \$/year

When you choose the capacity basis option, enter a \$/MW value in Year 1 dollars for the annual capacity payment.

**Note.** SAM assumes the capacity payment rate in \$/MW is an annual rate. If you are given a daily or monthly rate, you should convert it to an annual rate. For example, a \$100/MW daily rate would be equivalent to \$36,500/MW annually. Similarly, a \$100/MW monthly rate would be \$1,200/MW annually.

When you choose the fixed amount, enter a \$ value in Year 1 dollars for the annual capacity payment.

You can also click **Sched** and **Edit** to use the [Edit Schedule](#) window to enter a different payment amount for each year of the analysis period instead of a single value.



#### Capacity payment escalation

The annual escalation rate applies to the annual capacity payment in Years 2 and later. If you expect the capacity payment amount to increase from year to year, enter the escalation rate as an annual percentage.

The capacity payment escalation rate is disabled when you choose the Schedule option to enter annual values for the capacity payment amount.

**Capacity credit (eligible % of nameplate), %**

The percentage of the system's nameplate capacity that is eligible for capacity payments when you choose the **Capacity basis** option.

**System nameplate, MW**

The system's nameplate capacity. Note that the nameplate capacity is defined differently for different kinds of systems. For example for photovoltaic systems, the nameplate capacity is the total DC array capacity, and for wind and concentrating solar power systems, it is an AC capacity.

**Battery nameplate, MW**

The battery nameplate capacity from the Battery Storage page. SAM shows the battery capacity for reference, but does not include it in the capacity credit value. If your system includes batteries, you can adjust the capacity credit accordingly.

**Note.** The battery nameplate capacity is zero for systems with no batteries.

## 27.3 Time of Delivery Factors

**Note.** For the PPA Single Owner financial model, the time-of-delivery (TOD) factors are on the [Revenue](#) page. For the other PPA financial models, they are on the Time of Delivery Factors page.

Power generation projects sell all of the electricity that the system generates at a price negotiated through a power purchase agreement (PPA). For these projects, SAM allows you to define time-of-delivery (TOD) factors, or multipliers, to adjust the power price in any given hour of the year. TOD factors are not available for the residential and commercial financial models.

There are two ways to define TOD factors:

**TOD factors by schedule**

Use this option to define the factors using up to nine TOD periods with hour-by-month weekday and weekend schedule matrices, or to choose TOD schedules from a library of data for California.

**TOD factors by time step**

Use this option to assign a TOD factor to each simulation time step. For example, if you are running hourly simulations, you can assign a different TOD factor to each hour of the year.

SAM calculates the PPA price for each hour by multiplying the Year 1 [PPA price](#) shown in the results Summary page by the TOD factors you define for each of up to nine periods.

**Important Notes!**

If your analysis is for a project with a fixed PPA price that does not vary with time of day or month of year, use the **TOD Factor by Schedule** option, select **Uniform Dispatch** in the library and click **Apply values from library** to ensure that all of the PPA multiplier values are set to one.

When you click **Apply values from library**, SAM replaces the TOD data with data from the library. If you are using your own TOD data, you can use the **Save data to file** button at the bottom of the Time of Delivery Factors page to save your data.

**To populate values from the library:**

1. Choose **TOD factors by schedule**.
2. Click a row in the library.
3. Click **Apply values from library**.

**To specify your own TOD factors by schedule:**

1. Choose **TOD factors by schedule**.
2. Type a PPA price multiplier value for up to nine periods.
3. Use the schedule matrices to define the hour and month for each period as described below.

**To specify your own TOD factors by time step**

1. Choose TOD factors by time step.
2. Click **Edit data** and enter your TOD factors in the table.

**About TOD Factors by Schedule****TOD factors**

For each of the nine periods in the list, to calculate the PPA price in a given period, SAM multiplies the Year 1 PPA price by the multiplier you specify. For example, if Period 1 is the summer peak, defined as Noon to 7 p.m. in June through September with a multiplier of 2.38, and the Year PPA price is 6 cents/kWh, the price that the project would receive for each unit of electricity it generates during those summer peak hours would be 6 cents/kWh  $\times$  2.38 = 14.28 cents/kWh.

**Weekday Schedule, Weekend Schedule**

The weekday and weekend matrices allow you to associate each of the nine periods with a time of day and month of year. To use the matrices, you draw rectangles on the matrix with your mouse, and type a number with your keyboard for the period that applies to the times represented by the rectangles.

SAM arbitrarily defines the first day of time series data (the first 24 hours for hourly data) to be Monday on January 1, and assigns the remaining days of the year accordingly. SAM assumes that weekdays include Monday through Friday, and that weekends include Saturday and Sunday. SAM does not account for holidays or other special days. It also does not account for leap years, and does not include a day for February 29.

**To specify a weekday or weekend schedule:**

1. Assign values as appropriate to each of the up to nine periods.

- Use your mouse to draw a rectangle in the matrix for the first block of time that applies to period 2.

	12am	1am	2am	3am	4am	5am	6am	7am	8am	9am	10am	11am	12pm	1pm	2pm	3pm	4pm	5pm	6pm	7pm	8pm	9pm	10pm	11pm
Jan	1	1	1	1	1	1	1	1	1	1	1	1	1	1	1	1	1	1	1	1	1	1	1	1
Feb	1	1	1	1	1	1	1	1	1	1	1	1	1	1	1	1	1	1	1	1	1	1	1	1
Mar	1	1	1	1	1	1	1	1	1	1	1	1	1	1	1	1	1	1	1	1	1	1	1	1
Apr	1	1	1	1	1	1	1	1	1	1	1	1	1	1	1	1	1	1	1	1	1	1	1	1
May	1	1	1	1	1	1	1	1	1	1	1	1	1	1	1	1	1	1	1	1	1	1	1	1
Jun	1	1	1	1	1	1	1	1	1	1	1	1	1	1	1	1	1	1	1	1	1	1	1	1
Jul	1	1	1	1	1	1	1	1	1	1	1	1	1	1	1	1	1	1	1	1	1	1	1	1
Aug	1	1	1	1	1	1	1	1	1	1	1	1	1	1	1	1	1	1	1	1	1	1	1	1
Sep	1	1	1	1	1	1	1	1	1	1	1	1	1	1	1	1	1	1	1	1	1	1	1	1
Oct	1	1	1	1	1	1	1	1	1	1	1	1	1	1	1	1	1	1	1	1	1	1	1	1
Nov	1	1	1	1	1	1	1	1	1	1	1	1	1	1	1	1	1	1	1	1	1	1	1	1
Dec	1	1	1	1	1	1	1	1	1	1	1	1	1	1	1	1	1	1	1	1	1	1	1	1

- Type the number 2.

	12am	1am	2am	3am	4am	5am	6am	7am	8am	9am	10am	11am	12pm	1pm	2pm	3pm	4pm	5pm	6pm	7pm	8pm	9pm	10pm	11pm
Jan	1	1	1	1	1	1	1	1	1	1	1	1	1	1	1	1	1	1	1	1	1	1	1	1
Feb	1	1	1	1	1	1	1	1	1	1	1	1	1	1	1	1	1	1	1	1	1	1	1	1
Mar	1	1	1	1	1	1	1	1	1	1	1	1	1	1	1	1	1	1	1	1	1	1	1	1
Apr	1	1	1	1	1	1	1	1	1	1	1	1	1	1	1	1	1	1	1	1	1	1	1	1
May	1	1	1	1	1	1	1	1	1	1	2	2	2	2	2	2	1	1	1	1	1	1	1	1
Jun	1	1	1	1	1	1	1	1	1	1	2	2	2	2	2	2	1	1	1	1	1	1	1	1
Jul	1	1	1	1	1	1	1	1	1	1	2	2	2	2	2	2	1	1	1	1	1	1	1	1
Aug	1	1	1	1	1	1	1	1	1	1	2	2	2	2	2	2	1	1	1	1	1	1	1	1
Sep	1	1	1	1	1	1	1	1	1	1	1	1	1	1	1	1	1	1	1	1	1	1	1	1
Oct	1	1	1	1	1	1	1	1	1	1	1	1	1	1	1	1	1	1	1	1	1	1	1	1
Nov	1	1	1	1	1	1	1	1	1	1	1	1	1	1	1	1	1	1	1	1	1	1	1	1
Dec	1	1	1	1	1	1	1	1	1	1	1	1	1	1	1	1	1	1	1	1	1	1	1	1

- SAM shades displays the period number in the squares that make up the rectangle, and shades the rectangle to match the color of the period.

Payment Allocation Factor

Period 1:

Period 2:

Period 3:

Period 4:

**Weekday Schedule**

	12am	1am	2am	3am	4am	5am	6am	7am	8am	9am	10am	11am	12pm	1pm	2pm	3pm	4pm	5pm	6pm	7pm	8pm	9pm	10pm	11pm
Jan	1	1	1	1	1	1	1	1	1	1	1	1	1	1	1	1	1	1	1	1	1	1	1	1
Feb	1	1	1	1	1	1	1	1	1	1	1	1	1	1	1	1	1	1	1	1	1	1	1	1
Mar	1	1	1	1	1	1	1	1	1	1	1	1	1	1	1	1	1	1	1	1	1	1	1	1
Apr	1	1	1	1	1	1	1	1	1	1	1	1	1	1	1	1	1	1	1	1	1	1	1	1
May	1	1	1	1	1	1	1	1	1	1	2	2	2	2	2	2	1	1	1	1	1	1	1	1
Jun	1	1	1	1	1	1	1	1	1	1	2	2	2	2	2	2	1	1	1	1	1	1	1	1
Jul	1	1	1	1	1	1	1	1	1	1	2	2	2	2	2	2	1	1	1	1	1	1	1	1
Aug	1	1	1	1	1	1	1	1	1	1	2	2	2	2	2	2	1	1	1	1	1	1	1	1
Sep	1	1	1	1	1	1	1	1	1	1	1	1	1	1	1	1	1	1	1	1	1	1	1	1
Oct	1	1	1	1	1	1	1	1	1	1	1	1	1	1	1	1	1	1	1	1	1	1	1	1
Nov	1	1	1	1	1	1	1	1	1	1	1	1	1	1	1	1	1	1	1	1	1	1	1	1
Dec	1	1	1	1	1	1	1	1	1	1	1	1	1	1	1	1	1	1	1	1	1	1	1	1

**Weekend Schedule**

	12am	1am	2am	3am	4am	5am	6am	7am	8am	9am	10am	11am	12pm	1pm	2pm	3pm	4pm	5pm	6pm	7pm	8pm	9pm	10pm	11pm	
	E												E	E	E									E	E

5. Repeat Steps 2-4 for each of the remaining periods that apply to the schedule.

### About the TOD Schedules and Factors Library

The TOD Schedules and Factors library stores TOD data for three California electric utilities. For projects outside of California, you can specify your own TOD data.

For the 2015 and 2016 data in the library, the factors are from the following California Public Utilities Commission Advice Letters:

- PG&E 2016: [Advice Letter 4780-E](#) (January 22, 2016)
- SCE 2015: [Advice Letter 3244-E](#) (August 6, 2015)
- SDG&E 2015: [Advice Letter 2717-E](#) Attachment A (July 13, 2015)

**Important Note about California TOD Data!** PG&E and SDG&E offer different TOD options for projects that meet "energy only" or "full capacity deliverability" requirements, and SDG&E has options for "local" and "system" projects. Use your interconnection application and other documents to determine which TOD factors are appropriate for your project so you can choose the correct option in SAM.

For the 2009 and 2011 data, the factors are from the Market Price Referent (MPR) documents available on the [California Public Utilities Commission website](#). The SAM library includes values from Appendix B of Resolution E-4442 (2011) and Resolution E-4298 (2009).

The library is stored as a CSV file in the libraries folder of your SAM installation. For details about how to access the file, see [Libraries](#).

### Time of Delivery Factors in Results

SAM reports hourly, monthly, and annual TOD-related results. You can view these results on the [Data](#) and [Graphs](#) pages.

### Single Values

The single value results are available .

**First year energy from the system in TOD period  $n$** 

The total quantity of electricity delivered to the grid (and sold) by the system in Year one for each of the nine TOD periods, in kWh per year.

**First year energy price for TOD period  $n$** 

The power price for each of the nine TOD periods, equal to the product of the TOD factor for each period and the PPA price shown in the [Metrics table](#).

**First year revenue from the system in TOD period  $n$** 

The dollar value of electricity sold by the project in Year one for each of the nine TOD periods, in dollars per year.

## Monthly Data

The monthly variables are available on the Results page in [Graphs](#) and [Tables](#).

**First year energy from the system by month for TOD period  $n$** 

The total quantity of electricity delivered to the grid (and sold) by the system in Year one for the given TOD period in each month, in kWh.

**First year revenue from the system by month for TOD period  $n$** 

Total dollar value of electricity sold by the project in Year one for each month.

## Annual Data (All Years)

**Note.** The first row in the annual data table is equivalent to Year zero in the project [cash flow](#), before the system starts generating electricity.

**Energy produced by the system in TOD period  $n$** 

The total amount of electricity delivered to the grid (and sold) by the system in each year of the analysis period for each of the nine TOD periods.

**Revenue from the system in TOD period  $n$** 

The total dollar value of electricity sold by project in each year of the analysis period for each of the nine TOD periods.

# 28 Incentives and Depreciation

The Incentives and Depreciation input pages are where you describe financial incentives and depreciation parameters.

- [Incentives](#)
- [Depreciation](#)

## 28.1 Incentives

The Incentives page allows you to define the parameters for the following types of tax credits and cash incentives.

A tax credit is an amount that is deducted from the project's income tax:

- [Investment tax credits](#) (ITC)
- [Production tax credits](#) (PTC)

A cash incentive is an amount paid to the project that contributes to the project's annual cash flow:

- [Investment-based incentive](#) (IBI)
- [Capacity-based incentive](#) (CBI)
- [Production-based incentive](#) (PBI)

After running a simulation, you can display incentive amounts in the project [cash flow](#) and in results [graphs](#) and [tables](#).

**Note.** You can also model projects that qualify for an accelerated depreciation tax benefit using options on the [Depreciation](#) page.

### Investment Tax Credit (ITC)

An investment tax credit (ITC) reduces the project's annual tax liability in Year One of the project cash flow, the first year that the project is operational. SAM allows the ITC to be expressed either as a fixed amount or as a percentage of the project's total installed cost with a maximum limit.

#### Amount (\$)

The fixed dollar amount of the tax credit. A zero indicates no tax credit. A value of zero indicates no tax credit.

#### Percentage (%)

The amount of the tax credit expressed as a percentage. A value of zero indicates no tax credit. You can see the dollar amount of the ITC in the [cash flow](#).

For the commercial model, SAM applies the ITC percentage to the [net capital cost](#). If you want to model a situation where the percentage applies to less than the net capital cost, you can either modify the ITC percentage accordingly, or calculate the ITC amount outside of SAM and enter it as a fixed amount. For example, for a project with a \$10,000 net capital cost where 95% of those costs are eligible for a 30% ITC, you could either enter an ITC percentage of  $95\% \times 30\% = 28.5\%$ , or an ITC amount of  $30\% \times 95\% \times \$10,000 = \$2,850$ .

For the PPA models, the ITC percentage applies to the portion of each depreciation class that you specify as qualifying for the ITC on the [Depreciation](#) page. By default, the ITC percentage applies only to the basis for the portion of project costs that qualifies for 5-yr MACRS depreciation. For example, for a project with a [net capital cost](#) of \$1,000,000, ITC percentage of 30%, and 90% of the depreciation basis qualifies for the ITC, the ITC amount would be  $\$1,000,000 \times 30\% \times 90\% = \$270,000$ .

For systems with energy storage in the United States, the battery system is eligible for the ITC if it is charged by renewable energy for more than 75% of the time. For example, if the battery was charged by the renewable energy system and never by the grid, then it is eligible for the full ITC. If it is charged by renewable energy 80% of the time, then it is eligible for 80% of the ITC. If it is charged by renewable energy 70% of the time, then it is not eligible for the ITC. See Elgqvist, E.; Anderson, K.; Settle, E.

(2018). Federal Tax Incentives for Energy Storage Systems. 1 pp. NREL/FS-7A40-70384 ([PDF 207 KB](#)) for details. SAM displays **Battery charge energy from system (%)** in the Metrics table on the Results page [Summary](#) tab that you can use to determine how much of the battery's charging energy comes from renewable energy and adjust the ITC accordingly and run a new simulation to generate results with the adjusted ITC.

### Maximum (\$)

The upper limit of the tax credit in dollars. For tax credits with no limits, type the value 1e+038.

### Reduces Depreciation Basis

Applies only to commercial and PPA projects when one of the depreciation options is active on the [Depreciation](#) page.

The check boxes determine whether the basis used to calculate federal depreciation, state depreciation, or both should be reduced by the tax credit amount. When you check the box for an ITC, SAM reduces the depreciable basis by 50% of the ITC amount.

## Production Tax Credit (PTC)

A production tax credit (PTC) reduces the project's annual tax liability in Year One of the cash flow and subsequent years up to and including the year specified in the term variable. The PTC is a dollar amount per kilowatt-hour of annual electric output. If you specify an escalation rate, SAM increases the annual tax credit amount in years 2 and later in the cash flow by a percentage of the previous year's credit amount.

### Amount (\$/kWh)

The amount of the production tax credit as a function of the system's total electrical output in the first year expressed in dollars per kilowatt-hour of AC output. A zero indicates no tax credit.

### Term (years)

The number of years, beginning with year 1 on the project cash flow, that the tax credit applies. For example, a credit with a 10-year term would apply to years 1 through 10 of the project cash flow. A zero indicates no tax credit.

### Escalation (%/year)

The annual escalation rate that applies to the tax credit. SAM applies the escalation rate to years 2 and later of the project [cash flow](#). SAM does not apply the inflation rate that you specify on the [Financial Parameters](#) page to the PTC. For example, for a tax credit with a ten year term and two percent escalation rate, the tax credit in year 2 would be 2% greater than in year 1, and in year 3, 2% greater than in year 2, and so on.

For both the state and federal PTC, SAM rounds the annual PTC rate in cents/kWh to the nearest 0.1 cent as described in Notice 2010-37 of [IRS Bulletin 2010-18](#).

## Specifying Year-by-Year PTC Values

You can specify each PTC as either a single value (amount or percentage) that applies to all years in the analysis period defined on the Financial Parameters page, or you can assign a different value to each year in the analysis period using an annual schedule.

**Note.** Dollar values in the annual schedule are in nominal or current dollars. SAM does not apply inflation or escalation rates to values in annual schedules.



By default, you enter the PTC as a single value. The blue "Value" label on the blue and gray button next to the input variable indicates the single value mode is active for the variable.

	Amount
Federal	<input type="button" value="Value"/> <input type="button" value="Sched"/> <input type="text" value="0 \$/kWh"/>
State	<input type="button" value="Value"/> <input type="button" value="Sched"/> <input type="text" value="0 \$/kWh"/>

#### To specify a PTC using an annual schedule:

1. Click the grey and blue Value/Sched button so **Sched** is highlighted in blue. SAM replaces the variable's value with an Edit button.

<input type="button" value="Value"/> <input checked="" type="button" value="Sched"/>	<input type="button" value="Edit..."/>
--	--

2. Click **Edit**.
3. Change **Number of values** to the the analysis period from the Financial Parameters page. The number of rows in the table should be the number of years in the analysis period.
4. In the table of values, either type a value in each row, or click Paste to paste values from your computer's clipboard. Row 1 is for Year 1.

To delete a value, select it and press the Delete key on your keyboard.

You must type a value for each year. If you delete a value, SAM will clear the cell, and you must type a number in the cell or SAM will consider the schedule to be invalid. Type a zero for years with no value.

## Investment Based Incentive (IBI)

An investment-based incentive (IBI) is a cash payment to the project in Year One of the project cash flow. SAM allows the IBI to be expressed either as a fixed amount or as a percentage of the project's total installed cost with a maximum limit.

Note that if you specify two incentives from the same source (federal, state, utility, other) as both a fixed amount and a percentage of the total installed cost, SAM includes both amounts in the total incentive amount.

### Amount (\$)

The fixed dollar amount of the incentive. A zero indicates no incentive.

### Percentage (%)

The amount of the investment tax credit expressed as a percentage of the total installed cost displayed on the system costs page. A zero indicates no incentive.

### Maximum (\$)

The upper limit of the incentive in dollars. For incentives with no limits, type the value 1e+099.

## Tax Implications

The check boxes in the Taxable Incentive and Reduces Depreciation and ITC Bases columns determine whether each IBI qualifies as income for tax purposes, reduces the basis used to calculate the ITC, or reduces the basis used to calculate the depreciation amount, respectively.

### Taxable Incentive

Determines whether the incentive payment is subject to federal or state income tax.

When you check a Taxable Incentives check box for an incentive, SAM multiplies the applicable federal and state tax rate by the incentive amount and adds it to the income tax amount in the appropriate years of the project [cash flow](#).

The state and federal tax rates are inputs on the [Financial Parameters](#) page.

### Reduces Depreciation and ITC Basis

Determines whether the incentive reduces the basis used to calculate depreciation for commercial and PPA projects, and whether it reduces the basis used to calculate the ITC amount for projects with an investment tax credit.

The options only apply to projects with one or more ITCs specified on the [Tax Incentives](#) page.

When you check **Reduces Depreciation and ITC Basis** for an incentive, SAM does one or both of the following:

- Subtract the amount of the incentive or tax credit amount from the [net capital cost](#) before calculating the ITC amount.
- SAM subtract 50 percent of the incentive or tax credit amount from the depreciation basis in each applicable year of the project life.

**Note.** You can see the depreciation and ITC amounts in the project [cash flow](#).

## Capacity Based Incentive (CBI)

A capacity-based incentive (CBI) is a payment to the project in Year One of the project cash flow. SAM allows the CBI to be expressed as a function of the system's rated capacity in watts. The system's rated capacity depends on the technology:

- Photovoltaic systems: DC watts of array capacity.
- Concentrating solar power systems: AC watts of power block nameplate capacity.
- Generic fossil: AC watts of power block nameplate capacity.

Check an option for each capacity based incentive that applies to the project, and enter values to specify the credit amount, percentage, term, and annual escalation rate as applicable.

### Amount (\$/W)

The amount of the incentive as a function of the system's nameplate electric capacity expressed in dollars per watt. A zero indicates no incentive.

### Maximum (\$)

The upper limit of the incentive in dollars. For incentives with no limits, type the value 1e+099.

## Tax Implications

The check boxes in the Taxable Incentive and Reduces Depreciation and ITC Bases columns determine whether each CBI qualifies as income for tax purposes, reduces the basis used to calculate the ITC, or reduces the basis used to calculate the depreciation amount, respectively.

### Taxable Incentive

Determines whether the incentive payment is subject to federal or state income tax.

When you check a Taxable Incentives check box for an incentive, SAM multiplies the applicable federal and state tax rate by the incentive amount and adds it to the income tax amount in the appropriate years of the project [cash flow](#).

The state and federal tax rates are inputs on the [Financial Parameters](#) page.

### Reduces Depreciation and ITC Basis

Determines whether the incentive reduces the basis used to calculate depreciation for commercial and PPA projects, and whether it reduces the basis used to calculate the ITC amount for projects with an investment tax credit.

The options only apply to projects with one or more ITCs specified on the [Tax Incentives](#) page.

When you check **Reduces Depreciation and ITC Basis** for an incentive, SAM does one or both of the following:

- Subtract the amount of the incentive or tax credit amount from the [net capital cost](#) before calculating the ITC amount.
- SAM subtract 50 percent of the incentive or tax credit amount from the depreciation basis in each applicable year of the project life.

**Note.** You can see the depreciation and ITC amounts in the project [cash flow](#).

### Production Based Incentive (PBI)

A production-based incentive (PBI) is a cash payment to the project specified as a dollar amount per kilowatt-hour of annual electric output.

**Note.** For the [Single Owner](#) and [Leveraged Partnership Flip](#) financial models, you can specify whether the PBI payments are available for debt service.

#### Amount (\$/kWh)

The amount of the incentive as a function of the system's total electrical output in the first year expressed in dollars per kilowatt-hour of AC output. A zero indicates no incentive.

#### Term (years)

The number of years, beginning with Year One of the project cash flow, that the incentive applies. For example, an incentive with a 10-year term would apply to years one through 10 of the project cash flow. A zero indicates no incentive.

#### Escalation (%/year)

The annual escalation rate that applies to the incentive. SAM applies the escalation rate to years two and later in the cash flow. For example, for an incentive with a ten year term and two percent escalation rate, the incentive in year two would be two percent greater than in Year One, and in year three, two percent greater than in year two, and so on.

**Note.** If you use an annual schedule to assign PBI amounts to specific years, SAM ignores the escalation rate.

### Tax Implications

The check boxes in the Taxable Incentive column determine whether each PBI qualifies as income for tax purposes, reduces the basis used to calculate the PBI, or reduces the basis used to calculate the depreciation amount, respectively.

**Note.** For the Partnership Flip with Debt and Sale Leaseback financial models, the PBI is included in the total project revenue, so is considered taxable income by default. If you clear the Taxable Incentive box for these models to model the PBI as non-taxable income, SAM makes the taxable PBI amount negative so that it is not included in the total income tax.

### Taxable Incentive

Determines whether the incentive payment is subject to federal or state income tax.

When you check a Taxable Incentives check box for an incentive, SAM multiplies the applicable federal and state tax rate by the incentive amount and adds it to the income tax amount in the appropriate years of the project [cash flow](#).

The state and federal tax rates are inputs on the [Financial Parameters](#) page.

### PBI and Debt Service

For the Single Owner and Partnership Flip with Debt models, you can specify whether the PBI is available for debt service. If the PBI is available for debt service, SAM includes it in the total revenue as taxable income, otherwise it is included in the total pre-tax cash flow as part of the cash flow from operating activities.

#### PBI available for debt service

When you check the option for a PBI, SAM includes the PBI amount in the cash available for debt service (CAFDS).

### Specifying Year-by-Year Values for PBI Values

You can specify each PBI as either a single value (amount or percentage) that applies to all years in the analysis period defined on the Financial Parameters page, or you can assign a different value to each year in the analysis period using an annual schedule.

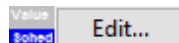
**Note.** Dollar values in the annual schedule are in nominal or current dollars. SAM does not apply inflation and escalation rates to values in annual schedules.

By default, you enter the PBI as a single value. The blue "Value" label on the blue and gray button next to the input variable indicates the single value mode is active for the variable.



#### To specify a PBI using an annual schedule:

1. Click the grey and blue Value/Sched button so **Sched** is highlighted in blue. SAM replaces the variable's value with an Edit button.



2. Click **Edit**.
3. Change **Number of values** to the the analysis period from the Financial Parameters page. The number of rows in the table should be the number of years in the analysis period.
4. In the table of values, either type a value in each row, or click Paste to paste values from your computer's clipboard. Row 1 is for Year 1.

To delete a value, select it and press the Delete key on your keyboard.

You must type a value for each year. If you delete a value, SAM will clear the cell, and you must type a number in the cell or SAM will consider the schedule to be invalid. Type a zero for years with no value.

## 28.2 Depreciation

### Depreciation for the Commercial Model

The depreciation inputs represent the decrease in value of project assets over the analysis period. Depreciation reduces federal and state taxable income, shown under *Tax Effect on Equity* in the project [cash flow](#).

For the Commercial financial model, SAM assumes that the depreciation method you choose applies to the entire depreciable basis. For these projects, the depreciable basis in each year of the project cash flow is the total installed cost less any incentives you specify as reducing the depreciation basis on the [Incentives](#) page:

$$\text{Depreciable Basis} = \text{Total Installed Cost} + \text{Total Construction Financing Cost} - (\text{Total ITC} \times 0.5 + \text{Total IBI} + \text{Total CBI} + \text{Total PBI})$$

Where *Total Installed Cost* is from the System Costs page, and *ITC* includes all tax credits that you specified on the Incentives page to reduce the depreciation basis, and *IBI*, *CBI*, and *PBI* include all incentives you specified to reduce the depreciation basis.

**Note.** After running a simulation, you can verify the depreciation percentages and amounts in the [cash flow](#) in the rows under Tax Effect on Equity.

#### **No Depreciation**

The project does not claim a depreciation tax deduction.

#### **5-yr MACRS**

Modified Accelerated Cost Recovery System depreciation schedule offered by the Federal government and some states using a five-year life and half-year convention.

This tax deduction, expressed as a percentage of the depreciable basis, applies to the first five years of the project life as follows: 20%, 32%, 19.2%, 11.52%, 11.52%, and 5.76%.

#### **Straight Line (specify years)**

A depreciation schedule offered by the Federal government and some states.

SAM calculates the depreciation percentage for the straight line depreciation option by dividing the analysis period by the number of years:

$$\text{SL Depreciation Percentage} = \text{Analysis Period (years)} \div \text{SL Number of Years (years)} \times 100\%$$

#### **Custom (specify percentages)**

Allows you to assign a depreciation deduction as a percentage of the total installed cost for each year in the project life.

To specify a custom depreciation schedule, click **Custom (specify percentages)**, and then click **Edit**

to open the Edit Schedule Window. Each row in the table represents a year in the analysis period. For **# Values**, type a number equal to or greater than the analysis period. (SAM ignores any values you enter for years after the analysis period.) For each year in the table, type a percentage. SAM will calculate the depreciation amount for each year in the [cash flow](#) by multiplying the percentage you specify for that year by the depreciable basis described above.

## Depreciation for PPA Financial Models

The Depreciation options allow you to specify how SAM calculates depreciation amounts and to specify an optional bonus depreciation.

The depreciation basis is the [net capital cost](#).

For projects with the Investment Tax Credit (ITC), when you check the **Reduces Depreciation Basis** check box for the ITC the [Incentives](#) page, SAM reduces the depreciation basis by 50% of the ITC amount as required by U.S. Internal Revenue Service rules.

The net capital cost is the sum of the total installed cost from the System Costs page, and debt, other financing fees, and reserve funding from the Financial Parameters page, less investment-based and capacity-based incentives from the Incentives page. SAM shows the depreciation basis calculation in the [cash flow](#).

SAM makes the following simplifying assumptions:

- To represent depreciation of assets with different classes or service lives, you can specify an allocation as a percentage of the net capital cost to each of up to six different depreciation methods.
- State and federal depreciation bases are the same, except for bonus depreciation.
- Investment-based incentives and capacity-based incentives reduce the depreciation basis proportionally.

### **Depreciation Classes**

Each row in the Depreciation Classes box represents a recovery period (5, 15, 20, or 39 years) and depreciation method (MACRS or Straight Line) based on the guidelines in the United States tax code. See U.S. Internal Revenue Service Publication 946 (<http://www.irs.gov/pub/irs-pdf/p946.pdf>) for details.

The following table shows the depreciation percentage by year for each depreciation class:

Years 1-10	1	2	3	4	5	6	7	8	9	10
5-yr MACRS	20.0	32.0	19.2	11.5	11.5	5.8				
15-yr MACRS	5.0	9.5	8.6	7.7	6.9	6.2	5.9	5.9	5.9	5.9
5-yr SL	10.0	20.0	20.0	20.0	20.0	10.0				
15-yr SL	3.3	6.7	6.7	6.7	6.7	6.7	6.7	6.7	6.7	6.7
20-yr SL	2.5	5.0	5.0	5.0	5.0	5.0	5.0	5.0	5.0	5.0
39-yr SL	1.3	2.6	2.6	2.6	2.6	2.6	2.6	2.6	2.6	2.6
Years 11-20	11	12	13	14	15	16	17	18	19	20
15-yr MACRS	5.9	5.9	5.9	5.9	5.9	3.0				
15-yr SL	6.7	6.7	6.7	6.7	6.7	3.3				
20-yr SL	5.0	5.0	5.0	5.0	5.0	5.0	5.0	5.0	5.0	5.0
39-yr SL	2.6	2.6	2.6	2.6	2.6	2.6	2.6	2.6	2.6	2.6
Years 21-30	21	22	23	24	25	26	27	28	29	30
20-yr SL	2.5									
39-yr SL	2.6	2.6	2.6	2.6	2.6	2.6	2.6	2.6	2.6	2.6
Years 31-40	31	32	33	34	35	36	37	38	39	40
39-yr SL	2.6	2.6	2.6	2.6	2.6	2.6	2.6	2.6	2.6	1.3

Each depreciation class has an associated value or set of check boxes listed under Federal and State Allocations, Bonus Depreciation, and ITC Qualification.

### Custom Depreciation Schedules

For projects outside of the U.S., or for analyses involving depreciation methods other than IRS methods, you can specify a custom depreciation schedule. To specify a custom depreciation schedule, click **Edit**, and enter a percentage for each year in the depreciation schedule table. (Enter values in the table as percentages, not decimals: For example type '25' for 25%.)

### Federal and State Allocations

For each depreciation class, specify an allocation. SAM assumes that the same depreciation method and allocations apply to both federal and state taxes.

SAM assumes the half-year convention for all depreciation methods.

To model a project with no depreciation, enter zero for all depreciation methods.

### Bonus Depreciation

The bonus depreciation applies in Year One as a percentage of the allocations that you specify for the standard depreciation.

Specify a percentage and check the box for each depreciation allocation that qualifies for the bonus depreciation.

For example, for a federal bonus depreciation that is 100% of the 5 yr MACRS depreciation class, if you specified the following depreciation allocations: 80% 5 yr MACRS, 1.5% 15 yr MACRS, and 3% 15 yr Straight Line, you would enter 100% for **Federal**, check the **5-yr MACRS** box, and clear the remaining boxes.

**Tip.** The Tax Relief, Unemployment Insurance Reauthorization, and Jobs Creation Act of 2010 extended the bonus depreciation incentive through 2010. Projects placed in service in 2011 qualify for 100% bonus depreciation, while projects placed in service in 2012 qualify for 50% bonus depreciation. Note that these bonus depreciation provisions are temporary.

### ITC Qualification

Check the box for each depreciation allocation that qualifies for investment tax credits (ITC). For example, if you check the box for 5-yr MACRS, and the 5-yr MACRS allocation is 90%, then the ITC basis would be 90% of the [net capital cost](#). If the ITC basis is the net capital cost, check the box for all of the depreciation allocations.

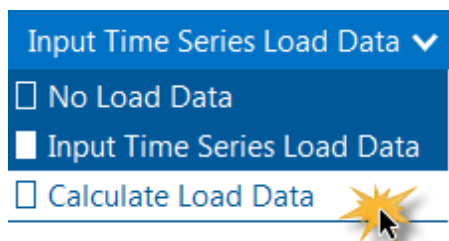
## 29 Electricity Rates and Load

For projects with the [residential or commercial](#) or [third party ownership](#) financial model that buy and sell electricity at retail rates, you specify a rate structure (net metering, energy rates, demand charges, and monthly charges) on the [Electricity Rates](#) page, and a building or facility load on the [Electric Load](#) page.

- [Electric Load](#)
- [Electricity Rates](#)
- [Electricity Bill Results](#)

### 29.1 Electric Load

The Electric Load page allows you to specify the electric load for systems with either the Residential or Commercial [financial model](#). For these models, SAM assumes that electricity generated by the system reduces a building or facility's electricity consumption, and depending on the electricity rate structure on the [Electricity Rates](#) page, excess electricity is either sold to the electricity service provider, or accumulates toward net metering credits.



The image shows a dropdown menu for 'Input Time Series Load Data'. The menu is open, showing three options: 'No Load Data', 'Input Time Series Load Data', and 'Calculate Load Data'. The 'Input Time Series Load Data' option is selected, indicated by a white square next to it. A mouse cursor is pointing at the 'Calculate Load Data' option.

There are three options for specifying the building or facility's electric load:

- **No Load Data** is for a system that sells all of the power it generates at the retail electricity sell rates from the [Electricity Rates](#) page.



- Choose [Input Time Series Load Data](#) when you have hourly or subhourly time series load data.
- Choose [Calculate Load Data](#) to automatically calculate hourly load data from a monthly electricity bill and basic building energy parameters. This option is only available with the residential financial model for performance models that use a solar resource weather file.

**Notes.**

You can use the Download Electric Load [macro](#) to automatically import reference residential and commercial building load data from the [NREL OpenEI Database](#) to SAM.

For estimates of roof area available for different commercial building types, see the table at <https://www.energy.gov/eere/buildings/commercial-reference-buildings> and divide the total building area by the number of floors.

## Input Time Series Load Data

The Input Time Series Load Data option allows you to import hourly or subhourly load data from a text file, or paste it from a spreadsheet or other program. It also provides option for scaling the load data to better match the building's load or values from an electricity bill.

### Electric Load Data

#### Energy usage

Click **Edit data** to either cut and paste load data from another program or to import data from a properly formatted text file. See [Working with Time Series Load Data](#) for instructions.

#### Scaling factor (optional)

Use the scaling factor to scale up or down the entire data set by the same amount. This option is useful when both the daily profile and seasonal pattern of your load data reasonably approximate the building's load, but the annual total does not.

When you change the scaling factor value, SAM recalculates the monthly and annual energy and peak values shown on the Electric Load page so you can verify that the value is correct.

To calculate the load value during simulation, SAM multiplies the hourly or subhourly load data you by the scaling factor that you specify. For example, if you specify a scaling factor of 1.5, and the load at 2 p.m. on March 18th is 1.2 kW, SAM would use a load value of  $1.5 \times 1.2 = 1.8$  kW for that hour.

#### Normalize supplied load profile to monthly electricity bill data

This option allows you to specify the building's total monthly electricity consumption in kWh. SAM scales the hourly or subhourly data for each month accordingly. This is useful when the daily profiles of the load data reasonably approximate the building's load, but the monthly totals do not match the values on the monthly electricity bill.

For example, if the sum of the original load data for January is 1,000 kWh, and you enter a value of 1,500 kWh for January, SAM will scale each load value in January by  $1,500 \div 1,000 = 1.5$ . In that example, if the original load value on January 5 at 10 a.m. is 3 kW, the scaled value would be 4.5 kW.

#### Monthly energy usage (kWh)

Click **Edit values** to enter the building's monthly load in kWh from an electricity bill or other source. SAM scales the hourly or subhourly load to match the values you enter as described above.

### View load data

Opens the [time series data viewer](#) to display graphs of the load data.

## Monthly Load Summary

SAM displays the table of monthly and annual totals to help you verify that the load data is correct.

### Energy (kWh)

The Energy column displays the building's total electric load for each month.

SAM calculates the value by adding the hourly or subhourly values for each month and multiplying by the number of hours per time step. For example, for hourly data, the total energy value for January would be the sum of hourly load values in kW for Hours 1 to 744 multiplied by 1 hour per time step. For 15-minute load data, the value would be the sum of the subhourly values in kW multiplied by 0.25 hours per time step.

### Peak (kW)

The maximum load value in kW that occurs in each month.

### Annual Total

The total amount of electricity required by the building over an entire year, equivalent to the sum of the monthly energy values.

The annual total applies to year one of the analysis period. If you specify a load growth rate rate under **Annual Adjustment**, the annual total does not reflect load data in years two and later.

### Annual Peak

The maximum load value that occurs in the year.

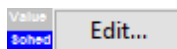
## Annual Adjustment

### Load growth rate

The load growth rate scales the load in years two and later by the percentage you specify. For example, if you specify a load escalation rate of 0.5% per year, for each year in the analysis period specified on the [Financial Parameters](#) page, SAM would increase the load value in each time step by 0.5% of the previous year's load value for the same time step.

You can also assign load escalation values to specific years using the annual schedule:

1. Click the grey and blue Value/Sched button so **Sched** is highlighted in blue. SAM replaces the variable's value with an Edit button.



2. Click **Edit**.
3. Change **Number of values** to the the analysis period from the Financial Parameters page. The number of rows in the table should be the number of years in the analysis period.
4. In the table of values, either type a value in each row, or click Paste to paste values from your computer's clipboard. Row 1 is for Year 1.

To delete a value, select it and press the Delete key on your keyboard.

You must type a value for each year. If you delete a value, SAM will clear the cell, and you must type a number in the cell or SAM will consider the schedule to be invalid. Type a zero for years with no value.

## Calculate Load Data

The calculate load data option for residential buildings allows you to use monthly electric bill data and basic building energy parameters to calculate an hourly load profile. You can use this option to estimate load data when you do not have access to more accurate data.

### Building Energy Load Profile Estimator

#### To use the estimator

- Enter values and choose options to describe the residential building's basic energy performance.
- The occupancy and temperature schedules allow you to adjust the daily profile of the load. Click **Edit** to enter adjustment factors for each of the 24 hours in a day. (The 24 values should all be one for no adjustments.)
- Under **Monthly Load Data**, type monthly total electricity consumption values for one year's worth of electricity bills.
- Click **View load data** to open the [time series data viewer](#) with the 8,760 hourly load profile generated by the estimator.

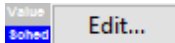
## Annual Adjustment

### Load growth rate

The load growth rate scales the load in years two and later by the percentage you specify. For example, if you specify a load escalation rate of 0.5% per year, for each year in the analysis period specified on the [Financial Parameters](#) page, SAM would increase the load value in each time step by 0.5% of the previous year's load value for the same time step.

You can also assign load escalation values to specific years using the annual schedule:

1. Click the grey and blue Value/Sched button so **Sched** is highlighted in blue. SAM replaces the variable's value with an Edit button.



2. Click **Edit**.
3. Change **Number of values** to the the analysis period from the Financial Parameters page. The number of rows in the table should be the number of years in the analysis period.
4. In the table of values, either type a value in each row, or click Paste to paste values from your computer's clipboard. Row 1 is for Year 1.

To delete a value, select it and press the Delete key on your keyboard.

You must type a value for each year. If you delete a value, SAM will clear the cell, and you must type a number in the cell or SAM will consider the schedule to be invalid. Type a zero for years with no value.

## Working with Time Series Load Data

SAM requires time series load data with at least hourly resolution to run a simulation involving an electric load. You can either import the data from a properly formatted text file, or copy and paste the data from a spreadsheet program or other software..

## Data Sources

The following examples are some sources of electric load data:

- Electrical measurements from a building or other load center. Some electricity service providers make load data available to their customers.
- Data generated by a building simulation model, such as the EnergyPlus Example File Generator, <http://apps1.eere.energy.gov/buildings/energyplus/cfm/inputs/>.
- Some electric service area operators provide system-wide load data on their websites. For examples, see California ISO and Midwest ISO websites.
- Sample residential load data generated by the EnergyPlus load data generator supplied with SAM in `\\samples\Simulated Electric Load Data - Residential` folder.

## Time Step and Convention

SAM requires load data in a single column of average kilowatt per time step values. The number of data rows depends on the time step.

For hourly data, SAM requires a column of 8,760 data rows, where each row contains a value in kilowatts representing the average power required by the load over the hour. For subhourly data, SAM requires a column of  $8,760 \times \text{Number of Times Steps per Hour}$  data rows, with kilowatt values representing the average electric power over the period of a single time step.

The [time convention](#) must follow the time convention of the weather file. For NREL typical meteorological year data (TMY2 and TMY3), the first row of data represents the time step beginning at midnight on January 1. SAM assumes that January first is a Monday.

When you use sub-hourly load data with hourly weather data, SAM uses hourly average load values to for the energy charge calculations, and the sub-hourly data to determine the peak load for demand charges.

## Importing Data from a File

SAM can import data from a text file that contains a single column of values representing the load in a single year. SAM ignores the first row, so you can use that row to store text describing the data. The number of rows depends on the number of time steps. For hourly data, the file should contain a total of 8,761 rows: The first row for header information, and the remaining rows for the load data. For 15-minute data, the file should contain  $1 + 8760 \times 4 = 35,041$  rows.

### To import load data from a properly formatted text file:

1. On the Electric Load page, choose the **Input Time Series Load Data** option.
2. Click **Edit Data**.
3. If the data is subhourly, click Change time step and type the data time step in minutes.
4. Navigate to the folder containing the load data file and open the file.  
SAM displays the data in the data table. Use the scroll bar to see all of the data.
5. Click **OK** to return to the Electric Load page.  
SAM displays monthly and annual load data under **Monthly Load Summary**.

After importing the data, you can use the scaling and escalation factors to scale the entire data set up or down, and to model a load that increases from year to year by the percentage that you specify.

## Pasting Load Data from your Computer's Clipboard

If you have load data in a spreadsheet or other program that allows you to copy columns of data to your computer's clipboard, you can paste the data into SAM. The data should be a single column of values in kilowatt-hours representing the load in a single year. The number of rows depends on the number of time steps. For hourly data, the column should contain 8,760 rows of load data.

### **To paste load data from your computer's clipboard:**

1. On the Electric Load page, choose the **Input Time Series Load Data** option.
2. Click **Edit Data**.
3. Open the spreadsheet or other program containing the load data, select the entire column of data, and copy it.
4. In SAM's Edit Data window, click **Paste**.  
SAM displays the data in the data table. Use the scroll bar to see all of the data.
5. Click **OK** to return to the Electric Load page.

## 29.2 Electricity Rates

The Electricity Rates page determines how SAM calculates the following:

- For distributed behind-the-meter projects, the cost of electricity purchases to meet a building or facility's electric load.
- For front-of-meter systems with battery storage, the cost of electricity purchases to charge the battery.

### **Retail Electricity Rates for Distributed Behind-the-meter Projects**

The electricity rate data determines how the project is compensated for electricity generated by the renewable energy system for the residential, commercial, and third party ownership financial models.

For the **residential and commercial** financial models, SAM assumes that the electricity customer owns and operates the system, and that electricity generated by the system offsets purchases of electricity from an electric service provider to meet a building or facility's [electric load](#). For these models, it reports the [electricity bill savings](#) and the project's [net present value \(NPV\)](#).

For the **third party ownership model**, SAM assumes that a third party owns and operates the renewable energy system, and that the electricity customer benefits from the electricity purchases offset by the system. SAM reports the value of these savings, accounting for the cost of the third party agreement as the project's [NPV](#).

In order to calculate the electricity bill savings, SAM calculates the both the electricity bill required to meet the electric load without the renewable energy system and the bill with the system, assuming the same rate structure for both cases. For details, see [electricity bill results](#).

**Note.** If you are modeling a rate switching scenario, where the electricity rate structure for the electricity bill without the system is different from the rate structure for the bill with the system, you can use the **Value of RE macro** to specify two different electricity rates and calculate key metrics based on the results of two separate simulations.

## Electricity Rates for Front-of-meter (FOM) Battery Storage

No Electricity Rate ▾

No Electricity Rate

Enable Electricity Rate

For front-of-meter battery storage (**PV battery or generic battery**) with the **PPA single owner model**, there are two options for the treatment of the cost of electricity for battery charging.

### No Electricity Rate

Choose this option to treat electricity purchases for battery charging as negative revenue. The value of this lost revenue is reported as **PPA revenue lost to self-consumption** in the project cash flow.

### Enable Electricity Rate

Choose this option to treat electricity purchases for battery charging as an operating expense in the project cash flow. This cost is reported in the project cash flow as the **Electricity purchase** line item for operating expenses.

**Note.** For the PPA partnership flip, sale leaseback, and merchant plant financial models, SAM treats electricity purchases for battery charging as negative revenue. The Enable Electricity Rate option is not available for these models.

For FOM battery storage, only the **Buy all / Sell all** metering option is available.

## Electricity Rates and Self Consumption

For photovoltaic systems with inverters that consume power at night or concentrating power systems (CSP) with night-time parasitic loads, the system may generate net negative power at night or during other times that the system is not generating power. For behind-the-meter projects, the cost of this power is included in the monthly energy charge. For front-of-meter projects with or without batteries, this power is treated as negative revenue.

## Overview

SAM's rate structure model is designed to have enough detail to model most features found on electricity service providers' rate sheets, but not so many details to make it too complicated to use. For example, SAM has a single fixed monthly charge input, while a rate sheet might have several fixed charges. To model those charges in SAM, you would add them up to a single value. SAM's rate structure model is also designed to be compatible with the OpenEI Utility Rate Database, so the inputs for fixed charges, energy and demand rates follow the data structure of the online database. There may be some features of your service provider's rate structure that SAM cannot model.

## Electricity Rates Glossary

The language used to describe rate structures and compensation for electricity generated by renewable energy systems depends on context. For example, some documents use the terms "net metering" and "net billing" to describe policies for compensating system owners for excess generation, while others use them to describe meter reading and billing processes. Those terms are also sometimes used to describe the same type of policy, and sometimes to differentiate between policies. This glossary defines terms as they are used in this documentation and in the SAM user interface.

**Grid**

Source of electricity delivered by the electricity service provider.

**Generation**

Electricity generated by the power system. It may be used to meet the load, or sold to the grid, or both. For systems with battery storage, generation may also be used to charge the battery.

**Excess generation**

Electricity generated by the power system in excess of the building or facility load that is delivered to the grid. Depending on the option you choose, excess generation for each month may be calculated by subtracting the total monthly load from the total monthly generation, or by subtracting the load from generation in each hourly (or subhourly) time step and adding up the resulting differences for each month. Compensation for excess generation depends on the option you choose, as described below.

**Load**

Electricity consumed by a residential or commercial building (or commercial facility). It may be supplied by the renewable energy system, grid, or both. For systems with battery storage, the load may also be supplied by the battery.

**Consumption**

Electricity delivered to the load from the grid, and purchased at the energy buy rate.

**Self consumption**

Electricity used by the system to charge the battery or meet system loads such as inverter for night-time consumption or concentrating solar power (CSP) system freeze protection.

**Sale**

Electricity sold to the electricity service provider (grid) by the power system owner. SAM reports electricity sales in kilowatt-hours and the value of those sales in dollars in the [time series](#) results. A negative sale value is a purchase, and vice versa.

**Purchase**

Electricity purchased from the electricity service provider (grid) by the power system owner. SAM reports electricity purchases in kilowatt-hours and the value of those purchases in dollars in the [time series](#) results.

**Flat rate**

A constant rate that does not change with time of day or year.

**Time-of-use (TOU) rate**

A rate that changes with time of day or year.

**Tiered rate**

A rate that changes with consumption. For example, an energy rate with two tiers might charge \$0.10/kWh for the first 500 kWh consumed in a month, and \$0.20/kWh for any kWh in excess of 500 kWh.

## Rate Structure

SAM can model the following rate structure features:

- **Fixed charge:** A fixed amount in dollars that the project pays at the end of each month. This amount is added to any other charges to calculate the monthly bill.
- **Minimum charge:** When the total monthly or annual bill amount falls below the minimum values, the minimum charge applies instead of the smaller amount.
- **Flat, time-of-use, and tiered energy rates:** Energy rates in dollars per kilowatt-hour that may vary with time of day and month of year, monthly energy consumption, or both.
- **Flat, time-of-use, and tiered demand rates:** Monthly fees in dollars per kilowatt paid by the project for the maximum grid demand in each specified period. Demand charges may be flat (constant), vary with time of day and year, or vary with monthly consumption. Maximum grid demand is the maximum power delivered by the grid over the month.
- **Annual escalation rate:** Applies to the total annual electricity bill in Years 2 and later of the project cash flow in addition to the inflation rate from the [Financial Parameters](#) page. Note that all rates and charges on the Electricity Rates page are in Year 1 dollars.

## Metering and Billing

SAM can model five different methods for compensating the system owner for excess generation. These methods are suitable for modeling net metering, net billing, and feed-in tariff policies. Those policies are defined differently in different jurisdictions. You can use the descriptions below to determine which method is best for your application.

The metering and billing category names are from Zinamen, O. et al. (2017) Grid-Connected Distributed Generation: Compensation Mechanism Basics. NREL/BR-6A20-68469. ([PDF 861 KB](#))

### Net energy metering

- Excess generation is the difference between the system's total monthly generation and total monthly load.
- For months with excess generation, the excess is "rolled over" to the next month's bill, effectively reducing the billable kilowatt-hours in that month.
- For a month when the excess generation rolled over from the previous month exceeds the total consumption in the current month, the remaining excess generation rolls over to the next month.
- If time-of-use periods apply to the energy rates, for excess generation that rolls over to a month with different periods, such as from a winter month to a summer month, SAM uses the period numbers at 12 a.m., 6 a.m., 12 p.m. and 6 p.m. for the current month to determine how to assign the excess generation to periods in the next month. See the **Electricity exports** data in the Electricity Rate by Tier and Period tables in the [electricity bill results](#).
- Net excess generation at the end of the annual true-up period is credited to the electricity bill for the month at the end of the period at the net excess generation rate. For the purpose of annual net excess compensation, monthly excess generation is calculated from the monthly total generation and load, regardless of time-of-use (TOU) periods. See **Net metering cumulative kWh credit earned for annual true-up** in the monthly [electricity bill results](#).

### Net energy metering with \$ credits

- Excess generation is the difference between the system's total monthly generation and total monthly load.



- For months with excess generation, the dollar value of the excess is credited to the next month's bill, reducing the bill amount in that month.
- The value of the credit is determined by the sell rate. If time-of-use or tiered rates apply, excess generation accumulates over the month by time-of-use period and tier, and SAM applies the appropriate sell rate to the monthly total excess generation for each period and tier. See **Net metering credit \$** in the monthly [electricity bill results](#).
- For a month when the credit from the previous month exceeds the total billable amount in the current month, the remaining amount is credited to the next month.
- If time-of-use periods apply to the energy rates, when the periods for next month are different than for this month, such as going from a winter month to a summer month, SAM uses the period numbers at 12 a.m., 6 a.m., 12 p.m. and 6 p.m. for the current month to determine how to assign the credit to periods in the next month.
- Any credit remaining at the end of the true-up period is credited to the electricity bill for the month at the end of the period.

#### Net billing

- Excess generation is the sum of differences between generation and load in each simulation time step over the month.
- For months with excess generation, the dollar value of the excess is credited to this month's bill. See **Net billing credits** in the monthly [electricity bill results](#).
- The value of the credit is determined by the sell rate. If time-of-use or tiered rates apply, excess generation accumulates over the month by time-of-use period and tier, and SAM applies the appropriate sell rate to the monthly total excess generation for each period and tier. Buy and sell rates can be defined on an hourly or subhourly basis instead of using hour-by-month schedules.
- For a month when the credit exceeds the total billable amount, the bill is negative, representing a cash payment to the system owner.
- Any credit remaining at the end of December is credited to the December electricity bill.

#### Net billing with carryover to next month

- Excess generation is the sum of differences between generation and load in each simulation time step over the month.
- For months with excess generation, the dollar value of the excess is credited to next month's bill. See **Net billing credits** in the monthly [electricity bill results](#).
- The value of the credit is determined by the sell rate. If time-of-use or tiered rates apply, excess generation accumulates over the month by time-of-use period and tier, and SAM applies the appropriate sell rate to the monthly total excess generation for each period and tier.
- For a month when the credit from the previous month exceeds the total billable amount for the current month, the remaining amount is credited to the next month.
- Any credit remaining at the end of the true-up period is credited to the electricity bill for the month at the end of the period.
- If time-of-use periods apply to the energy rates, when the periods for next month are different than for this month, such as going from a winter month to a summer month, SAM uses the period numbers at 12 a.m., 6 a.m., 12 p.m. and 6 p.m. for the current month to determine how to assign the credit to periods in the next month.

**Buy all / sell all**

- All of the power generated by the system is sold to the grid at the appropriate sell rate(s).
- All of the power required to meet the [electric load](#) is purchased from the grid at the appropriate buy rate(s).
- The monthly electricity bill is the sum of hourly (or subhourly) purchases. See **Electricity sales/purchases with system** in the hourly [electricity bill results](#).
- If tiers apply, generation and consumption accumulate separately to determine the buy and sell rate that applies to each block of energy.

**Notes.**

SAM can import retail electricity rate data from the online [OpenEI Electric U.S. Utility Rate Database](#) database.

All rates and charges on the Electricity Rates page are in Year 1 dollars. SAM applies both the inflation rate from the [Financial Parameters](#) page and the optional electricity bill escalation rate to calculate the electricity bill in Years 2 and later.

The electricity rate calculations work with the data from the [Electric Load](#) page. Be sure to specify a load that is appropriate for your project. Choose the No Load option on the Electric Load page only if your project sells all of the power it generates at the sell rates specified on the Electricity Rates page. The No Load option in combination with net metering results in a project that sells no power because the sell rate is set to zero for net metering.

The electricity bill does not affect the project's [levelized cost of energy \(LCOE\)](#), because the LCOE accounts for the cost of installing and operating the renewable energy system, but not the cost supplying electricity to the building or facility. The electricity bill does affect the project [net present value \(NPV\)](#), [payback period](#), and [net savings](#).

In [time series](#) results (hourly or subhourly), the electricity bill values are in the last hour of each month:

Date	Hour
Jan 31	744
Feb 28	1416
Mar 31	2160
Apr 30	2880
May 31	3624
Jun 30	4344
Jul 31	5088
Aug 31	5832
Sep 30	6552
Oct 31	7296
Nov 30	8016
Dec 31	8760

SAM assumes that the first day of the year is Monday, January 1 and does not account for leap years or for daylight savings time. (The last day is Monday, December 31).

## OpenEI Utility Rate Database

NREL's Open Energy Information (OpenEI) [Utility Rate Database](#) hosts a database of retail electricity rate structures for electric service providers in the United States and some other countries. SAM allows you to search the database and import rate structure data from the database to the input variables on the Electricity Rates page.

### Search for Rates

Click to search the OpenEI database for a rate structure and import the structure into SAM. This feature requires a [web connection](#):

1. In the OpenEI Utility Rate Database window, once the list of electric service providers appears, type either a zip code in **Zip code** or a few letters of the service provider's name in **Filter** to show providers who meet the criteria you typed.

Some service providers have shortcut names that SAM can recognize, for example, "PG&E" for Pacific Gas and Electric. The database includes a lookup table for many of these shortcut names, but you may need to use the provider's full name to find it in the list.

2. Click the name of the service provider to display a list of rate schedules available for that provider.
3. Click the rate structure name to choose it and display summary information.

By default, SAM only shows active rate structures for the sector suggested by the financial model of the case (commercial and residential), but you can change the option by clicking **Residential Only**, **Commercial Only**, or **All Schedules** in the upper right corner of the window. (**Lighting** shows rate schedules for street lighting that are not typically applicable to SAM.) "Active" rates are current rates that do not have an end date. Clear the **Show active** check box to show a list of all rates, including old rates with end dates.

4. Click **Download and apply utility rate** to download the data and populate the inputs on the Electricity Rates page.

#### Notes.

SAM does not use location information from the weather file to determine the utility service provider for your analysis.

In some cases, the data in the OpenEI database may be incorrect. Be sure to compare the data you import to the information on the utility service provider's rate sheet. You can provide feedback to the database team: Join the database community at <http://en.openei.org/community/group/utility-rate>.

### Save / Load Rate Data

You can save and load utility rate structure data from SAM to a text file of comma-separated values (CSV). This is useful for sharing load data between SAM project files or with other people. The utility rate data file format is a comma-separated list of input variables and their values.

#### Notes.

To see what the file format looks like, save the current rate to a file and open it with a spreadsheet program or text editor.

You can import and export each individual time-of-use rate table separately using the **Import** and **Export** buttons next to each table.

#### Save rate to file

Save the values of all input variables on the Electricity Rates to a text file. Use the .csv file extension when you save the file.

### Load rate from file

Import data from a properly-formatted text file to the inputs on the Electricity Rates page. To create a file to use as a template, click **Save rate to file**, and then replace the data in the template with your own rate data.

## Metering and Billing

The metering and billing options determine how SAM calculates the monthly electricity bill from the energy charges.

For detailed descriptions of each option see [Overview](#) above.

### Net energy metering

For the net energy metering option, electricity from the system is used to meet the load defined on the [Electric Load](#) page. Electricity purchases and sales are calculated from monthly totals. Any electricity needed from the grid is purchased at the **Buy rate** in the energy charges rate table. Sell rates in the table are disabled. The total monthly excess generation is credited in kWh to the next month's bill, except for December where it is credited as a dollar amount to the December bill at the **Sell rate for kWh credits remaining at the end of the year**.

### Net energy metering with \$ credits

Net metering with \$ credits is similar to net energy metering with grid purchases at the **Buy rate**, but excess generation is credited to next month's bill as a dollar amount determined by the **Sell rate** in the energy charges rate table instead of in kWh. The year-end sell rate are disabled. December's excess generation is credited to December's bill.

### Net billing

For the net billing option, electricity grid sales and purchases are calculated in each hourly or subhourly time step. For time steps when the system generates less power than the [electric load](#), power is purchased from the grid at the **Buy rate** for that time step. For time steps with excess generation, power is sold at the **Sell rate**.

### Net billing with carryover to next month

Net billing with carryover to next month is similar to net billing, except that the dollar value of excess generation is credited to the next month's bill.

### Buy all /sell all

For the buy all / sell all option, all of the power generated by the system in a given hourly or subhourly time step is purchased at the **Buy rate** for that time step, and all of the power required to meet the electric load is sold to the grid at the **Sell rate**.

### Compensation rate for net excess generation, \$/kWh

For the net energy metering option, any excess generation at the end of the annual true-up period is credited to the true-up month's bill at the net excess generation compensation rate. This compensation rate is disabled for all other metering and billing options.

### Roll over net excess compensation to future bills, \$/kWh

For the net energy metering option, when the net excess generation compensation is greater than the monthly bill at the end of the true-up period (accounting for the monthly or annual minimum), if this box is checked, the compensation rolls over to future months.

**Month for end of true-up period**

For the net energy metering, net energy metering with \$ credits options, and net billing with carryover to next month options, the month when net annual excess generation compensation is calculated. The compensation is also applied to this month.

**Use hourly (subhourly) buy/sell rates instead of TOU rate**

For any of the metering or billing other than net energy billing, you can import time series buy and sell rates instead of using the tiered time-of-use rates in the energy charges rate table.

When you check **Use hourly (subhourly) sell rates instead of TOU rates**, the **Sell** column in the energy charge rate table disappears because the time series rates apply instead of the time of use rates. Similarly, when you enable hourly/subhourly buy rates, the **Buy** column in the energy charge rate table disappears.

To use time series rates, click the check box and click **Edit array** to enter or import time series rates in the [Edit Array](#) window.

**Hourly (subhourly) sell rates, \$/kWh**

An array of sell rates for each simulation time step. The simulation time step is determined by the time step of the data in your weather file. For hourly data, you should provide 8,760 values. For 30-minute data, 17,520 values, for 15-minute data, 35,040 values, etc.

**Hourly (subhourly) buy rates, \$/kWh**

An array of buy rates for each simulation time step. The simulation time step is determined by the time step of the data in your weather file. For hourly data, you should provide 8,760 values. For 30-minute data, 17,520 values, for 15-minute data, 35,040 values, etc.

**Fixed Charge**

A fixed monthly charge is a fee that the project pays to the electric service provider and does not depend on the quantity of electricity consumed or generated by the project.

**Fixed monthly charge, \$**

A fixed dollar amount that applies to all months.

**Minimum Charges**

Minimum charges apply when either the monthly or annual electricity bill falls below a minimum value.

**Monthly minimum charge, \$**

If the monthly electricity bill with system for a given month is less than the monthly minimum, the bill for that month is the monthly minimum charge.

**Annual minimum charge, \$**

The minimum annual charge for Year 1. If the annual electricity bill with system for Year 1 is less than the minimum value, SAM sets the Year 1 annual bill to the minimum value. For the purposes of the annual minimum charge, the year starts January 1 and ends December 31. The annual minimum charge does not affect the monthly electricity bill.

**Note.** Like all of the dollar values on the Electricity Rates page, the minimum charge amounts are Year 1 values. If you apply an annual minimum charge, the monthly electricity bill with system data shown in the [Results](#) does not reflect the annual minimum charge.

## Annual Escalation

The escalation rate is an annual percentage increase that applies to the monthly electricity bill in Years 2 and later. Escalation is in addition to the inflation rate.

**Note.** Three factors affect the annual electricity bill value from year to year: The electricity bill escalation rate, inflation rate from the [Financial Parameters](#) page, and degradation rate from the [Lifetime](#) page.

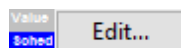
### Electricity bill escalation rate, \$/yr

The escalation rate is a single value that applies in addition to the inflation rate. For example, for an annual building load of 1,000 kWh, flat buy rate of \$0.10/kWh, escalation rate of 1%/yr, and an inflation rate of 2.5%/yr, the Year 1 annual electricity bill without system would be \$100, Year 2 = \$104, Year 3 = \$107, etc.

In some cases, it may be appropriate to use an annual schedule to define a different escalation rate for each year. When you specify the escalation rate using an annual schedule, SAM applies only the escalation rate and excludes inflation from the calculation of out-year values.

### To specify annual escalation rates (optional):

1. Click the grey and blue Value/Sched button so **Sched** is highlighted in blue. SAM replaces the variable's value with an Edit button.



2. Click **Edit**.
3. Change **Number of values** to the the analysis period from the Financial Parameters page. The number of rows in the table should be the number of years in the analysis period.
4. In the table of values, either type a value in each row, or click Paste to paste values from your computer's clipboard. Row 1 is for Year 1.

To delete a value, select it and press the Delete key on your keyboard.

You must type a value for each year. If you delete a value, SAM will clear the cell, and you must type a number in the cell or SAM will consider the schedule to be invalid. Type a zero for years with no value.

## ▼ Description and Applicability

These variables help you identify the rate structure but do not affect simulation results. If you download rate structure data from the Utility Rate Database, SAM populates the variables automatically.

### **Name**

The name or title of the rate structure.

### **Schedule**

The schedule name, often an alphanumeric designation used by the electric service provider.

### **Source**

A description of the data source.

If you downloaded the rate structure from the [OpenEI database](#), the source is a web link to the rate's entry page on the OpenEI website where you can find a link to the original source document. You can use your mouse to select and copy the link and paste it into your web browser.

**Description**

Text describing the rate structure.

**Applicability**

The applicability values are from the U.S. Utility Rate Database, and are for your reference. These values do not affect SAM simulations.

**Energy Charges**

Energy charges are charges that apply to power delivered to the load from the grid. The time-of-use energy rates are rates that vary with the time of day, or month of year, or both, as defined in the Weekday and Weekend schedules. The tiered energy rates also vary with the total monthly consumption.

For a **simple rate structure with no time-of-use periods or tiers**:

- Set Number of entries to 1 so that the table has a single row.
- Use Period 1 Tier 1 to define the buy and sell rates.  
For the single meter with rollover metering options (net metering), SAM ignores the sell rate, but you should set it to zero to avoid confusion.
- Set the time-of-use periods for all months and hours in the Weekday and Weekend schedules to 1.

Period	Tier	Max. Usage	Max. Usage Units	Buy (\$/kWh)	Sell (\$/kWh)
1	1	10000	kWh	0.08	0.1

For a rate structure with **time-of-use rates but no tiered rates**, assign buy and sell rates *only to Tier 1* of each of up to twelve periods in the schedule, and set the maximum usage value to a very large number (1e038 is the largest number SAM will accept). Then, use the Weekday and Weekend schedules to define the time of day and year that each period applies. For example,



Time-of-use and Tiered Energy Rates

Enable time-of-use and/or tiered energy rates

Import... Export... Copy Paste

Number of entries: 3

Period	Tier	Max. Usage	Max. Usage Units	Buy (\$/kWh)	Sell (\$/kWh)
1	1	1e+038	kWh	0.078462	0
2	1	1e+038	kWh	0.066502	0
3	1	1e+038	kWh	0.064842	0

Weekday

Weekend

Period	Tier	Max. Usage	Max. Usage Units	Buy (\$/kWh)	Sell (\$/kWh)
1	1	1e+038	kWh	0.078462	0
2	1	1e+038	kWh	0.066502	0
3	1	1e+038	kWh	0.064842	0

For a rate structure with **tiered rates but no time-of-use rates**, assign a monthly maximum usage, buy rate and sell rate (if applicable) to each of up to six tiers of *Period 1 only*. Then, assign Period 1 to all hours and months of the Weekday and Weekend schedules.

Time-of-use and Tiered Energy Rates

Enable time-of-use and/or tiered energy rates

Import... Export... Copy Paste

Number of entries: 4

Period	Tier	Max. Usage	Max. Usage Units	Buy (\$/kWh)	Sell (\$/kWh)
1	1	300	kWh	0.06	0.04
1	2	500	kWh	0.08	0.03
1	3	1000	kWh	0.12	0.01
1	4	1e+038	kWh	0.15	0.01

Weekday

Weekend

For a structure with **both time-of-use and tiered rates**, assign maximum usage, buy rates and sell rates to the tiers in each period as applicable. Then, use the Weekday and Weekend schedules to define the time of day and year that each period applies.

**Time-of-use and Tiered Energy Rates**  
 Enable time-of-use and/or tiered energy rates

Period	Tier	Max. Usage	Max. Usage Units	Buy (\$/kWh)	Sell (\$/kWh)
1	1	350	kWh	0.06	0
1	2	500	kWh	0.07	0
1	3	700	kWh	0.09	0
1	4	1e+038	kWh	0.1	0
2	1	350	kWh	0.06	0
2	2	500	kWh	0.09	0
2	3	700	kWh	0.1	0
2	4	1e+038	kWh	0.12	0
3	1	350	kWh	0.06	0
3	2	500	kWh	0.1	0
3	3	700	kWh	0.12	0
3	4	1e+038	kWh	0.15	0

**Weekday**

12am	1am	2am	3am	4am	5am	6am	7am	8am	9am	10am	11am	12pm	1pm	2pm	3pm	4pm	5pm	6pm	7pm	8pm	9pm	10pm	11pm
Jan	1	1	1	1	1	1	1	1	1	1	1	1	1	1	1	1	1	1	1	1	1	1	1
Feb	1	1	1	1	1	1	1	1	1	1	1	1	1	1	1	1	1	1	1	1	1	1	1
Mar	1	1	1	1	1	1	1	1	1	1	1	1	1	1	1	1	1	1	1	1	1	1	1
Apr	1	1	1	1	1	1	1	1	1	1	1	1	1	1	1	1	1	1	1	1	1	1	1
May	2	2	2	2	2	2	2	2	2	2	2	2	2	2	2	2	2	2	2	2	2	2	2
Jun	2	2	2	2	2	2	2	2	2	2	2	2	2	2	2	2	2	2	2	2	2	2	2
Jul	2	2	2	2	2	2	2	2	2	2	2	2	2	2	2	2	2	2	2	2	2	2	2
Aug	2	2	2	2	2	2	2	2	2	2	2	2	2	2	2	2	2	2	2	2	2	2	2
Sep	2	2	2	2	2	2	2	2	2	2	2	2	2	2	2	2	2	2	2	2	2	2	2
Oct	2	2	2	2	2	2	2	2	2	2	2	2	2	2	2	2	2	2	2	2	2	2	2
Nov	1	1	1	1	1	1	1	1	1	1	1	1	1	1	1	1	1	1	1	1	1	1	1
Dec	1	1	1	1	1	1	1	1	1	1	1	1	1	1	1	1	1	1	1	1	1	1	1

Period	Tier	Max. Usage	Max. Usage Units	Buy (\$/kWh)	Sell (\$/kWh)
1	1	350	kWh	0.06	0
1	2	500	kWh	0.07	0
1	3	700	kWh	0.09	0
1	4	1e+038	kWh	0.1	0
2	1	350	kWh	0.06	0
2	2	500	kWh	0.09	0
2	3	700	kWh	0.1	0
2	4	1e+038	kWh	0.12	0
3	1	350	kWh	0.06	0
3	2	500	kWh	0.1	0
3	3	700	kWh	0.12	0
3	4	1e+038	kWh	0.15	0

**Weekend**

12am	1am	2am	3am	4am	5am	6am	7am	8am	9am	10am	11am	12pm	1pm	2pm	3pm	4pm	5pm	6pm	7pm	8pm	9pm	10pm	11pm
Jan	1	1	1	1	1	1	1	1	1	1	1	1	1	1	1	1	1	1	1	1	1	1	1
Feb	1	1	1	1	1	1	1	1	1	1	1	1	1	1	1	1	1	1	1	1	1	1	1
Mar	1	1	1	1	1	1	1	1	1	1	1	1	1	1	1	1	1	1	1	1	1	1	1
Apr	1	1	1	1	1	1	1	1	1	1	1	1	1	1	1	1	1	1	1	1	1	1	1
May	2	2	2	2	2	2	2	2	2	2	2	2	2	2	2	2	2	2	2	2	2	2	2
Jun	2	2	2	2	2	2	2	2	2	2	2	2	2	2	2	2	2	2	2	2	2	2	2
Jul	2	2	2	2	2	2	2	2	2	2	2	2	2	2	2	2	2	2	2	2	2	2	2
Aug	2	2	2	2	2	2	2	2	2	2	2	2	2	2	2	2	2	2	2	2	2	2	2
Sep	2	2	2	2	2	2	2	2	2	2	2	2	2	2	2	2	2	2	2	2	2	2	2
Oct	2	2	2	2	2	2	2	2	2	2	2	2	2	2	2	2	2	2	2	2	2	2	2
Nov	1	1	1	1	1	1	1	1	1	1	1	1	1	1	1	1	1	1	1	1	1	1	1
Dec	1	1	1	1	1	1	1	1	1	1	1	1	1	1	1	1	1	1	1	1	1	1	1

**Weekday**

The time-of-day and month-of-year matrix that assigns a period representing set of time-of-use rates to the five working days of the week: Monday through Friday. SAM assumes that the year begins on Monday, January 1, in the hour ending at 1:00 am. See [Defining Weekday and Weekend Schedules](#) for instructions.

**Weekend**

The time-of-day and month-of-year matrix that assigns time-of-use periods to the two weekend days of the week: Saturday and Sunday.

**Energy Rate Table**

The energy rate table defines the rates, time-of-use periods, and tiers for up to 12 periods and 12 The energy charge rate table is where you define the energy charges. Each row in the table defines the buy and sell rates and tier limit for one period and tier.

**Tip.** It may be easier to create and modify a complex rate table in a text editor or spreadsheet program than in the table. You can use the **Import** and **Export** buttons to work with the data as comma-separated text outside of SAM. To see what the data format looks like, create a table in SAM and export it to a text file.

**Number of entries**

The total number of energy rates in the structure, equal to the product of the number of time-of-use periods and tiers. The number of rows in the table is equal to the number of entries. SAM automatically sizes the table based on the number of entries you type.

**Note.** If you change the number of entries to a smaller number, you will lose data in the rows when SAM resizes the table.

**Period (1-12)**

The time-of-use period must be a number between 1 and 12 (use the letters a = 10, b = 11, c = 12), and must also be defined in the either the [weekday or weekend schedule](#).

**Tier**

For each period, you can define one or more tiers. Each tier is defined by a maximum usage, buy rate, and sell rate, described below.

SAM accumulates tiers on a monthly basis, so any period that occurs in a given month must have the same number of tiers. For example, in the weekday schedule if the row for March contains Periods 2, 3, and 6, than those three periods must have the same number of tiers.

**Max. Usage**

For rate structures with tiered rates, the maximum usage is the maximum quantity of electricity purchased in a month for which the tier's rates apply.

For example, for a three-tier structure with one buy rate for electricity purchased up to 500 kWh/month, a second rate for electricity purchased over 500 kWh/month and up to 800 kWh/month, and a third rate for any electricity purchased in excess of 800 kWh/month, you would specify **Max Usage** for Tier 1 at 500 kWh, Tier 2 at 800 kWh, and Tier 3 at 1e+038 kWh.

**Max. Usage Units**

The units for each tier's maximum usage. To change the units, click the cell in the table for the units you want to change, and choose the units from the list that appears.

Period	Tier	Max. Usage	Max. Usage Units	Buy (\$/kWh)	Sell (\$/kWh)
1	1	50	kWh	0.078462	0
1	2	100	kWh	0.066502	0
1	3	200	kWh/kW	0.064842	0
1	4	300	kWh daily	0.052882	0
1	5	350	kWh/kW daily	0.06	0

**Buy (\$/kWh)**

The price paid by the project in dollars per kilowatt-hour to purchase electricity from the electric service provider for each period and tier.

**Sell (\$/kWh)**

The price paid to the project in dollars per kilowatt-hour by the electric service provider for electricity delivered by the project to the grid for each period and tier.

**Demand Charges**

A demand charge is a fee that the project pays to the electric service provider for the peak power in kW purchased from the grid in each month. Demand is defined as power purchased from the grid. Peak demand is the maximum demand over a given month or time-of-use period within a month.

You can use the demand charge inputs to specify a flat demand charge, a tiered demand charge structure, or a time-of-use demand charge structure. For a basic demand charge that applies to each month's peak demand, use the Fixed or Tiered Monthly Demand Charges rate table with Tier 1 for all months.

### Enable Demand Charge

Check the box to apply demand charges. You can disable demand charges without losing the rate and schedule data by clearing the check box.

## Fixed or Tiered Monthly Demand Charges Rate Table

A fixed or tiered monthly demand charge applies to the peak power delivered by the grid over a given month.

For a fixed monthly demand charge with no tiers, use Tier 1 to specify the peak demand in kW and demand charge in \$/kW for each month, and assign a charge of zero to Tiers 2-6. The peak demand for Tier 1 should be 1e+038, a very large number that represents no limit.

For a tiered monthly demand charge, specify a peak demand in kW and demand charge in \$/kW for each tier that applies for each month. The peak demand for highest tier and above should be 1e+038.

**Tip.** It may be easier to create and modify a complex rate table in a text editor or spreadsheet program than in the table. You can use the **Import** and **Export** buttons to work with the data as comma-separated text outside of SAM. To see what the data format looks like, create a table in SAM and export it to a text file.

### Number of entries

The number of demand charges in the rate structure. For a rate structure with a demand charge for each month, the number of entries should be 12. SAM sizes the table based on the number of entries.

**Note.** If you change the number of entries to a smaller number, you will lose data in the rows when SAM resizes the table.

### Month

The month for the demand charge. If a tiered demand charge applies to the month, specify two rows for with the same month, each with a different tier number and rates.

To choose a month, click a cell in the Month column, and choose a month from the list.

Month	Tier	Peak (kW)	Charge (\$/kW)
Jan	1	5	0
Jan	1	500	0
Feb	1	500	0
Mar	1	600	0
Apr	1	1e+038	0
May	1	1e+038	0
Jun	1	1e+038	0

### Tier

For each month, you can define one or more tiers. Each tier is defined by a peak demand and demand charge.

If tiers do not apply to the demand charges, then use Tier 1 for all months.

**Peak (kW)**

If the demand charge applies to the peak demand in the month, then type a very large number for the peak demand (1e+38 is the largest number SAM will accept).

If the demand charges are tiered, then enter each tier's peak demand in the Peak column.

**Charge (\$/kW)**

The demand charge for each month (and tier, if applicable).

## Time-of-use or Tiered Time-of-use Demand Charges Rate Table

A time-of-use or tiered time-of-use demand charge applies to the peak power delivered by the grid over a given period. If you define periods so that one month contains more than one period, that month's total demand charge will be the sum of the demand charges for each period.

For a demand charge that varies with time of day and year with no tiers, use Tier 1 to specify the peak demand in kW and demand charge in \$/kW for each period. Assign a period number to the Weekday or Weekend schedules by using your mouse to select a block in the matrix and typing the period number on your keyboard. Type the letters a, b, or c for the period numbers 10, 11, and 12, respectively. The demand charge for Tiers 2-6 should zero.

For a demand charge that varies with time of day and year with tiers, specify a peak demand in kW and demand charge in \$/kW for each tier that applies for each period. The peak demand for highest tier and above should 1e+038. Then assign a period number to the Weekday and Weekend matrices for each period.

**Tip.** It may be easier to create and modify a complex rate table in a text editor or spreadsheet program than in the table. You can use the **Import** and **Export** buttons to work with the data as comma-separated text outside of SAM. To see what the data format looks like, create a table in SAM and export it to a text file.

**Number of entries**

The number of demand charges in the rate structure. SAM sizes the table based on the number of entries.

**Note.** If you change the number of entries to a smaller number, you will lose data in the rows when SAM resizes the table.

**Period (1-12)**

The time-of-use period must be a number between 1 and 12, and must also be defined in the either the [weekday or weekend schedule](#).

**Tier**

For each period, you can define one or more tiers. Each tier is defined by a maximum usage, buy rate, and sell rate, described below.

**Peak (kW)**

The peak demand for the tier and period.

**Charge (\$/kW)**

The demand charge that applies to the tier and period.

## Defining Weekday and Weekend Schedules

The Weekday and Weekend matrices allow you to associate a period with a time of day and month of year. To use the matrices, draw rectangles on the matrix with your mouse, and type a number with your keyboard for the period that applies to the times represented by the rectangles.

**Note.** To assign a number greater than 9, use the letters a=10, b=11, and c=12.

SAM defines the first day of time series data (the first 24 hours for hourly data) to be Monday on January 1, and assigns the remaining days of the year accordingly. SAM assumes that weekdays include Monday through Friday, and that weekends include Saturday and Sunday. SAM does not account for holidays or other special days. It does not account for leap years, so therefore does not include a day for February 29. SAM also does not account for time changes such as for daylight savings.

### To specify a weekday or weekend schedule:

1. Assign values as appropriate to each of the up to nine periods.
2. Use your mouse to draw a rectangle in the matrix for the first block of time that applies to period 2.

	12am	1am	2am	3am	4am	5am	6am	7am	8am	9am	10am	11am	12pm	1pm	2pm	3pm	4pm	5pm	6pm	7pm	8pm	9pm	10pm	11pm
Jan	1	1	1	1	1	1	1	1	1	1	1	1	1	1	1	1	1	1	1	1	1	1	1	1
Feb	1	1	1	1	1	1	1	1	1	1	1	1	1	1	1	1	1	1	1	1	1	1	1	1
Mar	1	1	1	1	1	1	1	1	1	1	1	1	1	1	1	1	1	1	1	1	1	1	1	1
Apr	1	1	1	1	1	1	1	1	1	1	1	1	1	1	1	1	1	1	1	1	1	1	1	1
May	1	1	1	1	1	1	1	1	1	1	1	1	1	1	1	1	1	1	1	1	1	1	1	1
Jun	1	1	1	1	1	1	1	1	1	1	1	1	1	1	1	1	1	1	1	1	1	1	1	1
Jul	1	1	1	1	1	1	1	1	1	1	1	1	1	1	1	1	1	1	1	1	1	1	1	1
Aug	1	1	1	1	1	1	1	1	1	1	1	1	1	1	1	1	1	1	1	1	1	1	1	1
Sep	1	1	1	1	1	1	1	1	1	1	1	1	1	1	1	1	1	1	1	1	1	1	1	1
Oct	1	1	1	1	1	1	1	1	1	1	1	1	1	1	1	1	1	1	1	1	1	1	1	1
Nov	1	1	1	1	1	1	1	1	1	1	1	1	1	1	1	1	1	1	1	1	1	1	1	1
Dec	1	1	1	1	1	1	1	1	1	1	1	1	1	1	1	1	1	1	1	1	1	1	1	1

3. Type the number 2.

	12am	1am	2am	3am	4am	5am	6am	7am	8am	9am	10am	11am	12pm	1pm	2pm	3pm	4pm	5pm	6pm	7pm	8pm	9pm	10pm	11pm
Jan	1	1	1	1	1	1	1	1	1	1	1	1	1	1	1	1	1	1	1	1	1	1	1	1
Feb	1	1	1	1	1	1	1	1	1	1	1	1	1	1	1	1	1	1	1	1	1	1	1	1
Mar	1	1	1	1	1	1	1	1	1	1	1	1	1	1	1	1	1	1	1	1	1	1	1	1
Apr	1	1	1	1	1	1	1	1	1	1	1	1	1	1	1	1	1	1	1	1	1	1	1	1
May	1	1	1	1	1	1	1	1	1	1	2	2	2	2	2	2	1	1	1	1	1	1	1	1
Jun	1	1	1	1	1	1	1	1	1	1	2	2	2	2	2	2	1	1	1	1	1	1	1	1
Jul	1	1	1	1	1	1	1	1	1	1	2	2	2	2	2	2	1	1	1	1	1	1	1	1
Aug	1	1	1	1	1	1	1	1	1	1	2	2	2	2	2	2	1	1	1	1	1	1	1	1
Sep	1	1	1	1	1	1	1	1	1	1	1	1	1	1	1	1	1	1	1	1	1	1	1	1
Oct	1	1	1	1	1	1	1	1	1	1	1	1	1	1	1	1	1	1	1	1	1	1	1	1
Nov	1	1	1	1	1	1	1	1	1	1	1	1	1	1	1	1	1	1	1	1	1	1	1	1
Dec	1	1	1	1	1	1	1	1	1	1	1	1	1	1	1	1	1	1	1	1	1	1	1	1

4. SAM displays the period number in the squares that make up the rectangle.
5. Repeat Steps 2-4 for each of the remaining periods that apply to the schedule.

Period	Tier	Max. Usage	Max. Usage Units	Buy (\$/kWh)	Sell (\$/kWh)	
1	1	1e+038	kWh	0.07344	0.07339	
2	1	1e+038	kWh	0.09325	0.0932	
3	1	1e+038	kWh	0.07237	0.07232	
4	1	1e+038	kWh	0.09898	0.09893	
5	1	1e+038	kWh	0.13935	0.1393	

	Weekday	12am	1am	2am	3am	4am	5am	6am	7am	8am	9am	10am	11am	12pm	1pm	2pm	3pm	4pm	5pm	6pm	7pm	8pm	9pm	10pm	11pm
Jan		1	1	1	1	1	1	1	1	2	2	2	2	2	2	2	2	2	2	2	2	2	1	1	1
Feb		1	1	1	1	1	1	1	1	2	2	2	2	2	2	2	2	2	2	2	2	2	1	1	1
Mar		1	1	1	1	1	1	1	1	2	2	2	2	2	2	2	2	2	2	2	2	2	1	1	1
Apr		1	1	1	1	1	1	1	1	2	2	2	2	2	2	2	2	2	2	2	2	2	1	1	1
May		3	3	3	3	3	3	3	3	4	4	4	4	5	5	5	5	5	5	4	4	4	3	3	3
Jun		3	3	3	3	3	3	3	3	4	4	4	4	5	5	5	5	5	5	4	4	4	3	3	3
Jul		3	3	3	3	3	3	3	3	4	4	4	4	5	5	5	5	5	5	4	4	4	3	3	3
Aug		3	3	3	3	3	3	3	3	4	4	4	4	5	5	5	5	5	5	4	4	4	3	3	3
Sep		3	3	3	3	3	3	3	3	4	4	4	4	5	5	5	5	5	5	4	4	4	3	3	3
Oct		3	3	3	3	3	3	3	3	4	4	4	4	5	5	5	5	5	5	4	4	4	3	3	3
Nov		1	1	1	1	1	1	1	1	2	2	2	2	2	2	2	2	2	2	2	2	2	1	1	1
Dec		1	1	1	1	1	1	1	1	2	2	2	2	2	2	2	2	2	2	2	2	2	1	1	1

### 29.3 Electricity Bill Results

The electricity bill is the residential or commercial building owner's monthly electricity payment to the electric service provider. In order to calculate the value of the energy generated by the power system, SAM calculates the electricity bill with the system and the bill without the system. The savings is the difference between the two.

The descriptions below are for the simulation [results](#) based on electricity bill calculations.

**Notes.**

SAM uses the same electricity rate to calculate the bill with and without the system. If you are modeling a rate switching scenario, where the electricity rate structure for the electricity bill without the system is different from the rate structure for the bill with the system, you can use the **Value of RE System macro** to specify two different electricity rates and calculate key metrics based on the results of two separate simulations.

If SAM reports zeroes for rates or charges in the variables described below where you expect to see non-zero values, it is possible that you are modeling a system with no [electric load](#), which means that all electricity generated by the system is delivered to the grid at the sell rate that applies in each hour that electricity is generated.

SAM displays the monthly charges with the system and without the system. Both cases are for the same electricity rate schedule as it is defined on the [Electricity Rates](#) page:

**With system:** The customer's electricity bill for an electric load met by power from both the renewable energy system and grid.

**Without system:** The customer's electricity bill if the entire load is met with grid power.

## Summary

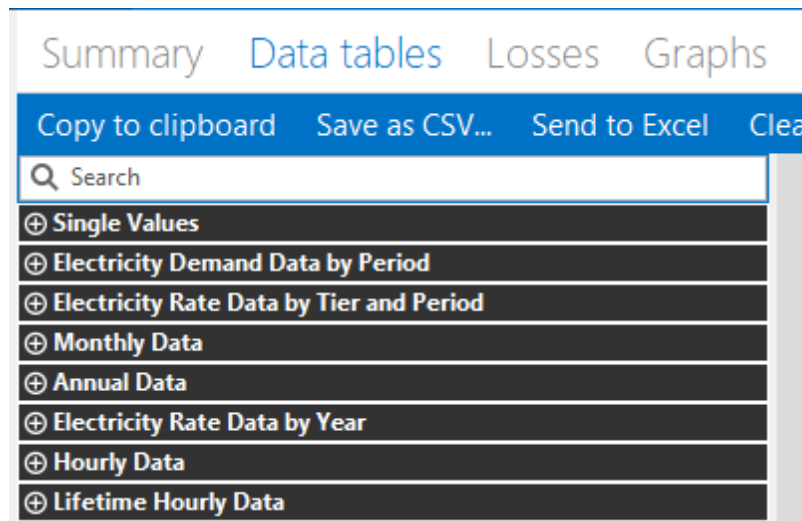
Metric	Value
Annual energy (year 1)	8,741 kWh
Capacity factor (year 1)	21.3%
Energy yield (year 1)	1,863 kWh/kW
Performance ratio (year 1)	0.78
Levelized COE (nominal)	9.95 ¢/kWh
Levelized COE (real)	7.94 ¢/kWh
Electricity bill without system (year 1)	\$1,514
Electricity bill with system (year 1)	\$566
Net savings with system (year 1)	\$948
Net present value	\$3,693
Simple payback period	10.8 years
Discounted payback period	20.8 years
Net capital cost	\$12,772
Equity	\$2,554
Debt	\$10,217

The following [metrics](#) are based on the utility bill calculations:

- [Electricity bill without system](#) and [Electricity bill with system](#) in the Metrics table is the Year 1 total annual electricity bill with and without the system.
- [Net savings with system](#) is the difference between the bill without system and the bill with system, and is also the value of electricity savings for Year 1 on the project cash flow.
- [Net present value \(NPV\)](#) is the present value of the project's annual after-tax cash flow. A positive value indicates the value of the electricity bill savings is greater than the cost of the system over the analysis period. A negative value indicates that the project costs more than it saves.
- [Payback period](#) is affected by the net savings: A project with more savings will have a shorter payback period than one with less savings.



## Data Tables



The Data Tables tab shows data for the electricity bill with and without the system over different periods. The following tables show data used for electricity bill calculations:

### Monthly Data

Shows monthly totals: Use this table to see how the monthly electricity bill is calculated from the fixed, energy, and demand components, and how credits for excess generation are applied.

### Annual Data

Sum of monthly totals for each year in the analysis period. Use this table to see how the value of electricity savings is calculated from the total annual bill with and without the system.

### Electricity Rate Data By Year

This table shows monthly totals over the analysis period in a month-by-year table.

### Electricity Rate Data by Tier and Period

For complex electricity rates with time-of-use (TOU) and tiered energy rates, these tables show energy charges for each month in Year 1 by TOU period and tier.

### Electricity Demand Data by Period

For electricity rates with TOU demand rates, these tables show demand charges for each month in Year 1.

### Hourly Data / Subhourly Data

The hourly/subhourly data tables shows time series power from the system, to/from the grid and to/from the battery. For the net billing and buy all / sell all metering options, the data shows grid sales and purchase amounts.

**Note.** The Lifetime Hourly/Subhourly Data tables show data from the performance model. They do not show data from the electricity bill calculations.

## Variable Descriptions

### AC energy / Monthly energy

Total monthly AC electricity generated by the power system. This electricity may be used to meet the electric load or be delivered to the grid.

### Demand charge (\$)

The demand charge component of the monthly electricity bill. The total demand charge in each month is the sum of the fixed and TOU demand charge.

The **fixed** demand charge is calculated from the demand rates by month with optional tiers rates on the [Electricity Rates](#) page.

The **TOU** demand charge is calculated from the demand rates by time-of-use and/or tiers rates on the Electricity Rates page.

### Demand peak (kW)

The peak electricity usage for each month. The demand charge is calculated from this value.

### Electricity bill (\$)

The total monthly electricity bill, calculated as the sum of the fixed, energy, and demand charges less any credits.

### Electricity load (kWh)

The total electricity load by month. Depending on the system design, the load may be supplied by the power system, grid, battery, or a combination.

### Electricity to/from grid (kWh)

The net total electricity to or from the grid. A positive value indicates net monthly export to the grid, a negative value indicates net monthly import from the grid.

### Electricity use (kWh)

The net total electricity supplied by the grid. A negative value indicates net export to the grid.

### Energy charge (\$)

The energy charge portion of the electricity bill, calculated from the rates for energy charges on the Electricity Rates page.

### Energy charge with system before credits (\$)

The energy charge portion of the electricity bill without credits for excess generation. Compare this value to the energy charge to see how credits affect the bill.

### Excess generation (kWh)

The net total monthly electricity generated by the power system in excess of the load, equal to the AC or monthly energy minus electricity load.

For the net energy metering options, this is the value used to determine the value of net metering credits.

For the net billing options, the excess generation is calculated on an hourly or subhourly basis, which you can see by comparing the time series results for lifetime electricity load and system power generated.

**Fixed monthly charge (\$)**

The fixed charge component of the electricity bill, determined by the fixed monthly charge on the Electricity Rates page.

**Minimum charge (\$)**

When the monthly minimum charge on the Electricity Rates page is greater than zero, if the sum of the monthly fixed, energy, and demand charges less any credits is less than the minimum, the monthly bill is set to the monthly minimum charge.

The annual minimum charge on the Electricity Rates page does not affect the monthly minimum charge, but does affect the total annual electricity bill. When the sum of monthly fixed, energy, and demand charges less any credits is less than the minimum annual charge, the annual bill is set to the annual minimum charge. You can see the annual electricity bill and minimum charge on the Annual Data variables.

**Net billing credits (\$)**

For the net billing metering option and net billing with carryover to next month option, the value of credits for excess generation credited in dollars to the current month's electricity bill.

For the net billing with carryover to next month option, for the month at the end of the true-up period, the net billing credit includes any net excess compensation, which may roll over to subsequent months.

**Net metering credit (\$)**

For the net energy metering with \$ credits option, the value of credits for excess generation credit in dollars to the current month's electricity bill. For the month at the end of the true-up period, the net billing credit includes any net excess compensation.

**Net metering cumulative kWh credit earned for annual true-up (kWh)**

For the net energy metering option, SAM applies the cumulative credit in the true-up month to the electricity bill for that month at the compensation rate for net excess generation. If the credit amount is greater than the monthly bill, the monthly bill is negative and treated as net savings in the project cash flow.

**Note.** The net excess generation for annual true-up accumulates on a monthly basis regardless of time-of-use (TOU) periods.

Excess generation credits for monthly rollovers are allocated based the (TOU) schedule. To see how net metering credits accrue on a monthly basis, use the **Electricity Rate Data by Tier and Period** table to compare the electricity exports with system and electricity usage with system for each month.

## 30 Thermal Rates and Load

Topic for new thermal rates and load model.

## 30.1 Thermal Load

The Thermal Load page allows you to specify a thermal load for systems that generate usable heat. You can input heat usage data by importing hourly or subhourly heat usage data from a text file, or paste it from a spreadsheet or other program. It also provides options for scaling the time series load data to match annual or monthly heating requirements.

### Thermal Load Data

#### Heat usage

Click **Edit data** to either cut and paste load data from another program or to import data from a properly formatted text file. See [Working with Time Series Load Data](#) for instructions.

#### Scaling factor (optional)

Use the scaling factor to scale up or down the entire data set by the same amount. This option is useful when both the daily profile and seasonal pattern of your load data reasonably approximate the building's heat usage, but the annual total does not.

When you change the scaling factor value, SAM recalculates the monthly and annual energy and peak values shown in the monthly load summary so you can verify that the value is correct.

To calculate the load value during simulation, SAM multiplies the hourly or subhourly load data you by the scaling factor that you specify. For example, if you specify a scaling factor of 1.5, and the load at 2 p.m. on March 18th is 1.2 kW, SAM would use a load value of  $1.5 \times 1.2 = 1.8$  kW for that hour.

#### Normalize supplied load profile to monthly utility bill data

This option allows you to specify the building's total monthly heat usage in kWh. SAM scales the hourly or subhourly data for each month accordingly. This is useful when the daily profiles of the load data reasonably approximate the building's load, but the monthly totals do not match the monthly heat usage.

For example, if the sum of the original load data for January is 1,000 kWh, and you enter a value of 1,500 kWh for January, SAM will scale each load value in January by  $1,500 \div 1,000 = 1.5$ . In that example, if the original load value on January 5 at 10 a.m. is 3 kW, the scaled value would be 4.5 kW.

#### Monthly energy usage (kWh)

Click **Edit values** to enter the building's monthly heat usage in kWh. SAM scales the hourly or subhourly load to match the values you enter as described above.

#### View load data

Opens the [time series data viewer](#) to display graphs of the load data.

### Monthly Load Summary

SAM displays the table of monthly and annual totals to help you verify that the load data is correct.

#### Thermal load (kWh-t)

The Energy column displays the building's total thermal load for each month.

SAM calculates the value by adding the hourly or subhourly values for each month and multiplying by the number of hours per time step. For example, for hourly data, the total energy value for January would be the sum of hourly load values in kW for Hours 1 to 744 multiplied by 1 hour per time step. For 15-minute load data, the value would be the sum of the subhourly values in kW multiplied by 0.25 hours per time step.

**Peak (kW-t)**

The maximum load value in kW that occurs in each month.

**Annual Total**

The total amount of heat required by the building over an entire year, equivalent to the sum of the monthly energy values.

The annual total applies to year one of the analysis period. If you specify a load growth rate rate under **Annual Adjustment**, the annual total does not reflect load data in years two and later.

**Annual Peak**

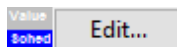
The maximum load value that occurs in the year.

**Annual Adjustment****Load growth rate**

The load growth rate scales the load in years two and later by the percentage you specify. For example, if you specify a load escalation rate of 0.5% per year, for each year in the analysis period specified on the [Financial Parameters](#) page, SAM would increase the load value in each time step by 0.5% of the previous year's load value for the same time step.

You can also assign load escalation values to specific years using the annual schedule:

1. Click the grey and blue Value/Sched button so **Sched** is highlighted in blue. SAM replaces the variable's value with an Edit button.



2. Click **Edit**.
3. Change **Number of values** to the the analysis period from the Financial Parameters page. The number of rows in the table should be the number of years in the analysis period.
4. In the table of values, either type a value in each row, or click Paste to paste values from your computer's clipboard. Row 1 is for Year 1.

To delete a value, select it and press the Delete key on your keyboard.

You must type a value for each year. If you delete a value, SAM will clear the cell, and you must type a number in the cell or SAM will consider the schedule to be invalid. Type a zero for years with no value.

## 30.2 Thermal Rates

The Thermal Rates page define the retail rates for heat purchased to meet the [thermal load](#), and for sales of excess heat generated by the system

**Buy Rate**

The buy rate is a retail price in dollars per unit of heat that the project pays for any heat required to meet thermal load that can not be met by the system.

**Set buy rate to fuel cost**

Set the buy rate to the fuel cost on the System Costs page.

**Nominal heat conversion efficiency, %**

When you choose the Set buy rate to fuel cost, use the nominal heat conversion efficiency to adjust the cost of heat.

**Flat buy rate, \$/kWh-t**

A fixed price for heat purchases.

**Time series buy rates**

Click **Edit array** to specify a buy rate for each time step in the simulation.

**Sell Rate**

The sell rate is a retail price in dollars per unit of heat that the project receives for any heat generated by the system in excess of the thermal load. SAM calculates excess heat for hourly (or subhourly) each time step.

**Flat buy rate, \$/kWh-t**

A fixed price for heat sales.

**Time series buy rates**

Click **Edit array** to specify a sell rate for each time step in the simulation.

**Annual Escalation**

The escalation rate is an annual percentage increase that applies to the annual heating bill in Years 2 and later. Escalation is in addition to the inflation rate from the [Financial Parameters](#) page.

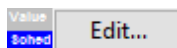
**Thermal rate escalation, %/year**

The escalation rate is a single value that applies in addition to the inflation rate. For example, for an annual thermal load of 1,000 kWh, flat buy rate of \$0.10/kWh, escalation rate of 1%/yr, and an inflation rate of 2.5%/yr, the Year 1 annual electricity bill without system would be \$100, Year 2 = \$104, Year 3 = \$107, etc.

In some cases, it may be appropriate to use an annual schedule to define a different escalation rate for each year. When you specify the escalation rate using an annual schedule, SAM applies only the escalation rate and excludes inflation from the calculation of out-year values.

**To specify annual escalation rates (optional):**

1. Click the grey and blue Value/Sched button so **Sched** is highlighted in blue. SAM replaces the variable's value with an Edit button.



2. Click **Edit**.
3. Change **Number of values** to the the analysis period from the Financial Parameters page. The number of rows in the table should be the number of years in the analysis period.
4. In the table of values, either type a value in each row, or click Paste to paste values from your computer's clipboard. Row 1 is for Year 1.

To delete a value, select it and press the Delete key on your keyboard.

You must type a value for each year. If you delete a value, SAM will clear the cell, and you must type a number in the cell or SAM will consider the schedule to be invalid. Type a zero for years with no value.

## 31 Results

SAM displays tables and graphs of results from the performance and financial models on the Results page.

For a general description of the Results page with screenshots, see the Getting Started topic [Results](#).

For instructions for displaying data on the Results page, see:

- [Summary](#)
- [Losses](#)
- [Graphs](#)
- [Data](#)
- [Cash Flow](#)
- [Time Series Data](#)
- [Notices](#)

For detailed descriptions of variables shown in the Results page tables and graphs, see

- [Financial Metrics](#)
- [Performance Metrics](#)
- [Cash Flow Variables](#)

### 31.1 Summary

The **Summary** tab displays the Metrics table with a selection of [results](#) for each case in the project file and a selection of graphs.

Use the [Data tables](#) tab to list all of the case's results, and [Graphs](#) tab to create more graphs of results.

#### Metrics Table

For a list and descriptions of the variables in the Metrics table, see

- [Financial Metrics](#) for metrics from the financial models, such as [levelized cost of energy \(LCOE\)](#), [levelized PPA price](#), [payback period](#), [IRR](#), etc..
- [Performance Metrics](#) for metrics from the performance models, such as [annual energy](#), [capacity factor](#), etc.

The Metrics table shows financial model results from the [Cash flow](#) tab and performance model results. For example, this Metrics table shows results for the detailed photovoltaic performance model and single owner financial model:

Metric	Value
Annual energy	37,211,968 kWh
Capacity factor	21.2%
First year kWhAC/kWDC	1,861 kWh/kW
Performance ratio	0.78
PPA price (Year 1)	10.33 ¢/kWh
PPA price escalation	1.00 %
Levelized PPA price (nominal)	11.20 ¢/kWh
Levelized COE (nominal)	10.48 ¢/kWh
Net present value	\$2,727,177
Internal rate of return (IRR)	11.00 %
Year IRR is achieved	20
IRR at end of analysis period	12.76 %
Net capital cost	\$41,179,084
Equity	\$19,478,956
Size of debt	\$21,700,130

Performance metrics

Financial metrics

You can [export data](#) from the Metrics table by right-clicking it (control-click if your mouse has one button) and choosing an option, **Copy table** to copy the data to your computer's clipboard, or **Copy as CSV** to export it to a comma-separated text file:

Metric	Value
Annual Energy	37,211,888 kWh
Capacity Factor	21.2%
First Year kWhAC/kWDC	1,861
Performance Ratio	0.817
PPA Price (Year 1)	10.31 ¢/kWh
PPA Price Escalation	1.00 %

Copy table


Copy as CSV

## Summary Graphs

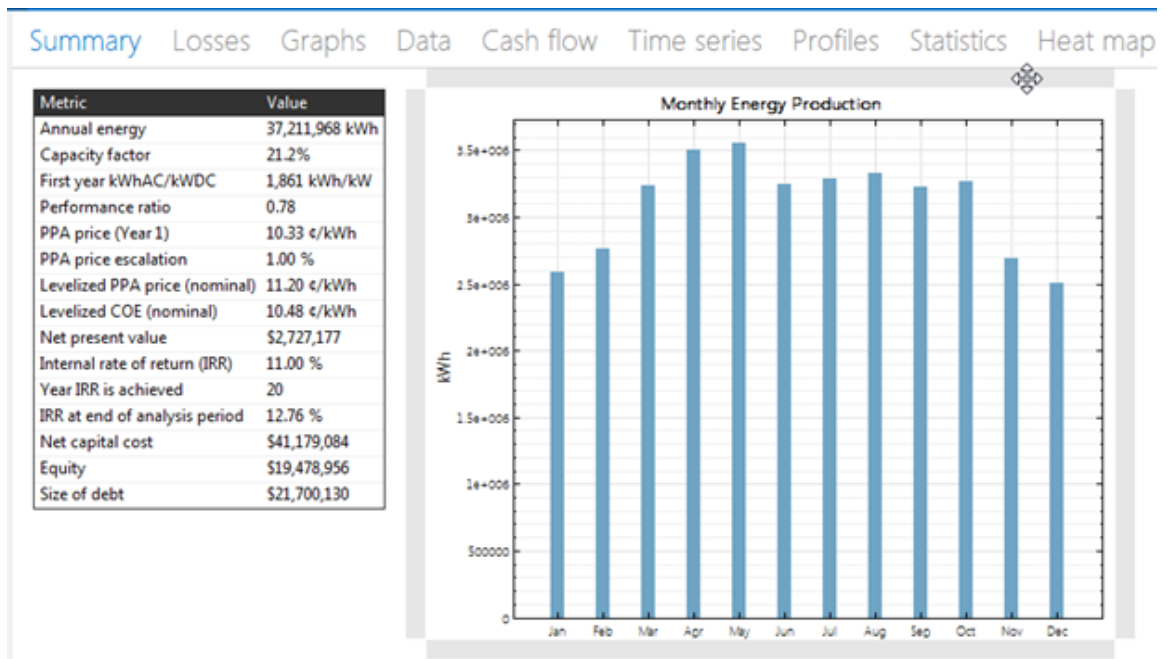
The summary graphs are the graphs on the Summary tab. You can create your own graphs on the [Graphs](#) tab.

To [export data or an image](#) of a graph, right-click it (control-click on a mouse with one button) and choose an option from the shortcut menu.


### To move a summary graph:

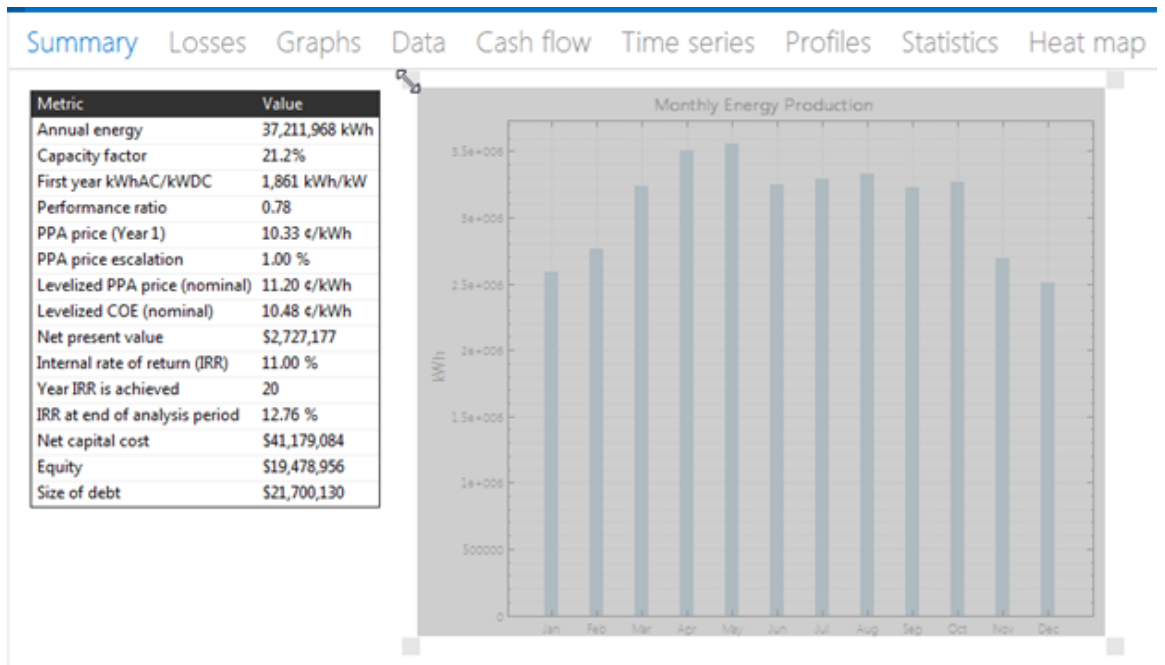
- Use your mouse to hover over an edge of the graph until the pointer changes to  and then drag the graph to a new position. You may need to resize other graphs to make room for the graph.





**To resize a summary graph:**

- Use your mouse to hover over a corner of the graph until the pointer changes to  and then drag the corner of the graph to make it larger or smaller.



**To reposition the legend in a graph:**

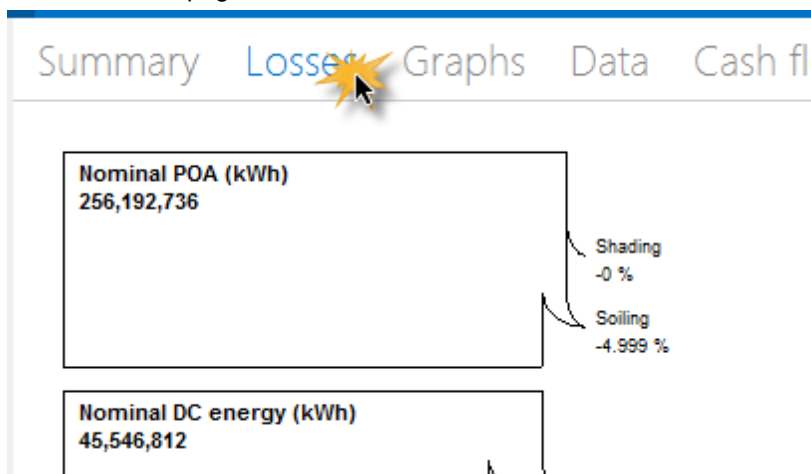
- Click the legend and drag it to a new position.

## 31.2 Losses

The **Losses** tab on the Results page displays a Sankey diagram showing the energy at different points in the system, and the source of energy losses at each point.

**To view the loss diagram:**

- On the Results page, click the **Losses** tab.



**Note.** SAM does not display an energy loss diagram for all of the performance models. If you do not see the Losses tab on the Results page, the diagram is not available.

### Using the Loss Diagram in your Documents

SAM includes a copy of the energy loss diagram in [reports](#).

You can also copy the diagram to your clipboard to use in documents using your operating system's clipping tool:

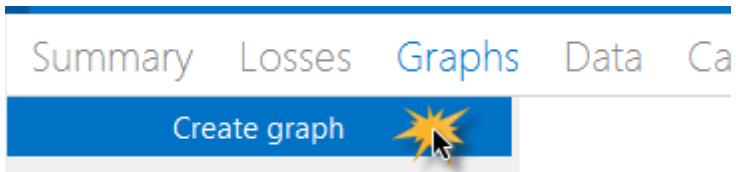
- In Windows 7, use the Snipping Tool (type "Snip" in the Windows search box). In Windows 7 and older versions of Windows, you can use the Print Screen key to copy an image of your screen to the clipboard.
- In OS X, press the Command-Shift-4 keys to drag an area on your screen and save it to an image file.

### 31.3 Graphs

The **Graphs** tab on the Results page allows you to create your own graphs of results data after running a simulation.

**To show and hide graphs:**

1. Click the **Graphs** tab at the top of the Results page.
2. Click **Create Graph**.



3. Choose a graph type, and type labels for the title and x- and y-axes.
4. In the list of variables, choose variables to include in the graph. Type a few letters of a variable name to filter the list.
5. You can adjust the width of graph lines, text style, legend position, and grid line style.

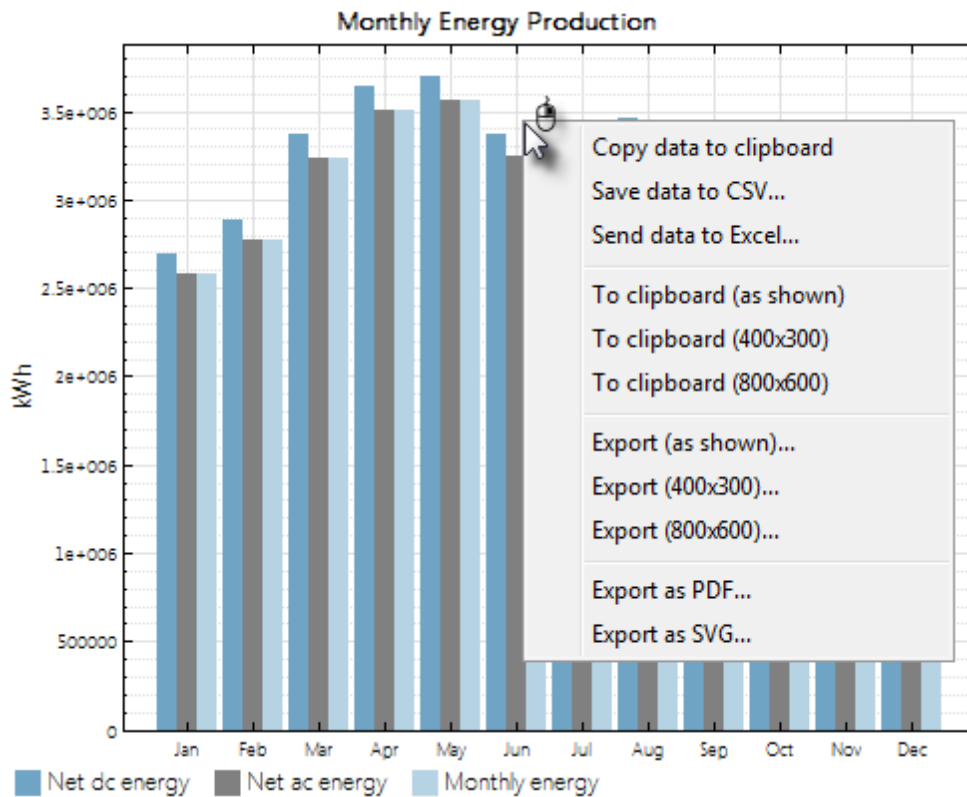
The screenshot shows the 'Create graph' dialog box on the left and a bar chart on the right. The dialog box has the following settings:

- Graph type: **Bar** (selected)
- Title: Monthly POA Irradiance
- X label: (empty)
- Y label: kWh/m<sup>2</sup>
- Size: (slider)
- Text: Modern
- Legend: Right
- Coarse grid:  Fine grid:
- Search: poa
- Single Values:
  - Annual POA beam radiation (nominal) (kWh)
  - Annual POA beam radiation after shading a
  - Annual POA total radiation (nominal) (kWh)
  - Annual POA total radiation after shading an
  - Annual POA total radiation after shading on
  - POA shading loss (%)
  - POA soiling loss (%)
- Monthly Data:
  - Monthly POA beam radiation (nominal) (kW
  - Monthly POA beam radiation after shading
  - Monthly POA total radiation (nominal) (kW)
  - Monthly POA total radiation after shading a
- Annual Data
- Hourly Data

The bar chart on the right is titled 'Monthly POA Irradiance' and shows data for each month from Jan to Dec. The y-axis is labeled 'kWh/m<sup>2</sup>' and ranges from 0 to 2.5e+007. The bars show a seasonal peak in May and a trough in December.

**To export the graph image or data:**

- To export data from a graph, right-click the graph and choose an export option:

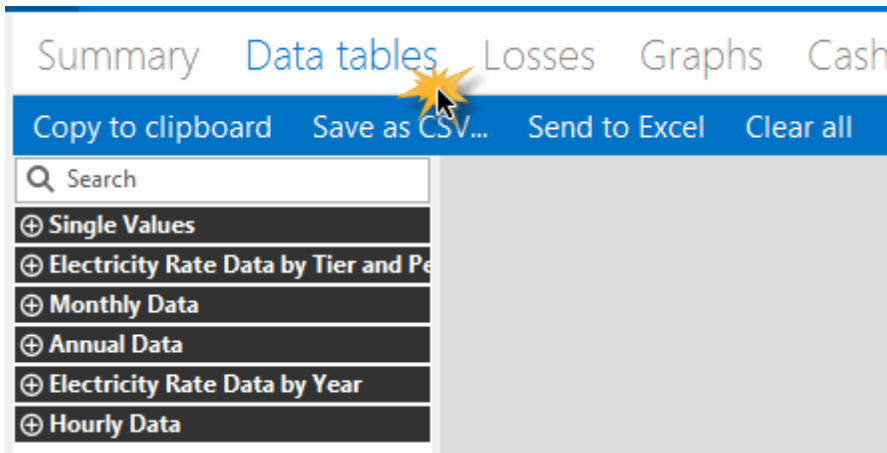


## 31.4 Data Tables

The **Data Tables** tab on the Results page allows you to create a table of time series data from the performance and financial models.

**To create a table of data:**

- On the Results page, click the **Data tables** tab. You should see a list of variable categories: Single Values, Monthly Data, etc. If you do not see the list, [run a simulation](#) to generate results.



- Expand the list to display variables in each category, and choose variables to display in the table. The categories depend on the number of values for each variable.

Type a few letters of the variable name to filter the list of variables.

	Electricity demand charge (TOU) with system (\$/mo)	Electricity demand charge (TOU) without system (\$/mo)
Jan	25000.7	25366.6
Feb	25348.1	26456.8
Mar	24943.2	26438.4
Apr	25611.8	26761.6
May	25974.9	27104.5
Jun	26430.9	27396.6
Jul	27009	28017.7
Aug	27065.3	28384.8
Sep	26594.5	27356.5
Oct	26207.3	27137.1
Nov	26531.5	26843.5
Dec	25215.9	25380.4

## Data Categories

The data categories are based on the number of values that a variable represents.

- ⊕ Single Values
- ⊕ Monthly Data
- ⊕ Annual Data
- ⊕ Hourly Data

### Single Values

Results that have a single value, including:

- Some input variable values from the [System Costs](#), [Financial Parameters](#), and [Incentive](#) pages.
- Annual totals or averages of hourly performance model results, or time-dependent pricing data.

### Monthly Data

Results that have of twelve values, including monthly averages and totals of hourly values

### Annual Data

Results that have a value for each year in the analysis period, including:

- [Cash flow](#) data
- Annual output data

**Note.** Row 1 in the annual data table is equivalent to Year zero in the project [cash flow](#).

### Hourly Data

Results with 8,760 hourly values from the performance model results.

**Note.** If you do not see the **Hourly Data** list, [run a simulation](#) to generate the list. SAM deletes stored hourly data when you close the file to save storage space.

For subhourly simulations, SAM displays an additional category for the smallest time step, e.g., **1 Minute Data**, **15 Minute Data**, etc.

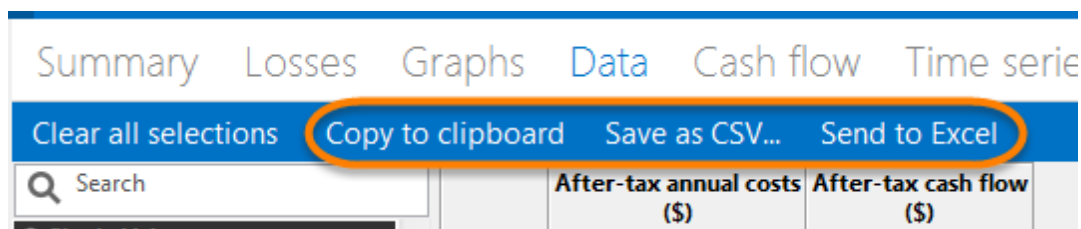
### Utility Rate Data by Tier/Period

Results from the Residential and Commercial financial models showing monthly dollar and kWh totals by utility rate structure time-of-use period and tier.

### Utility Rate Data by Year

Results from the Residential and Commercial financial models showing monthlydollar and kWh totals totals by year.

## Exporting Data from Tables



SAM offers three options for exporting data:

- **Copy to clipboard** copies the table to your clipboard. You can paste the entire table into a word processing document, spreadsheet, presentation or other software.
- **Save as CSV** saves the table in a comma-delimited text file that you can open in a spreadsheet program or text editor.
- **Send to Excel** saves the table in an Excel file (Windows only).

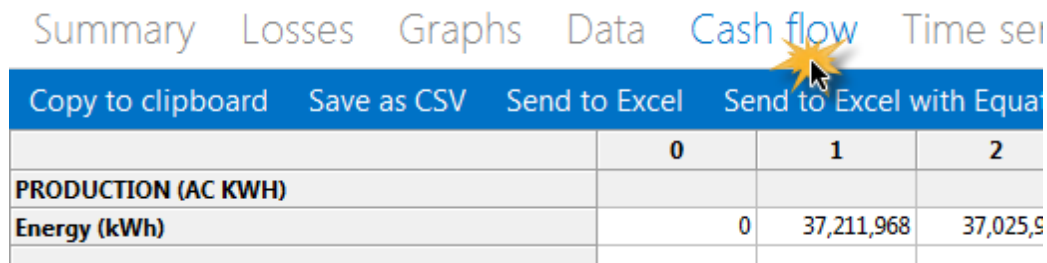
## 31.5 Cash Flow

The **Cash flow** tab displays the project cash flow calculated by the financial model.

For descriptions of cash flow variables, see [Cash flow variables](#).

### To view the project cash flow:

- On the Results page, click the **Cash flow** tab.



	0	1	2
<b>PRODUCTION (AC KWH)</b>			
<b>Energy (kWh)</b>	0	37,211,968	37,025,9

SAM offers three options for exporting cash flow data:

- Copy to clipboard** copies the table to your clipboard. You can paste the entire table into a word processing document, spreadsheet, presentation or other software.
- Save as CSV** saves the table in a comma-delimited text file that you can open in a spreadsheet program or text editor.
- Send to Excel** (Windows only) creates an Excel workbook that contains the data from the cash flow, but no formulas.
- Send to Excel with Equations** (Windows only) exports the cash flow data to an existing Excel workbook that contains formulas to illustrate how SAM's internal cash flow calculations work. The workbooks are in the `runtime\spreadsheets` folder of your [SAM installation folder](#).

### Notes.

SAM makes cash flow calculations internally during the simulation. It does not use Excel to make the calculations. The two **Send to Excel** options are to help you analyze the cash flow data and understand how SAM's internal calculations work.

You can also display cash flow data by building a [data](#) table.

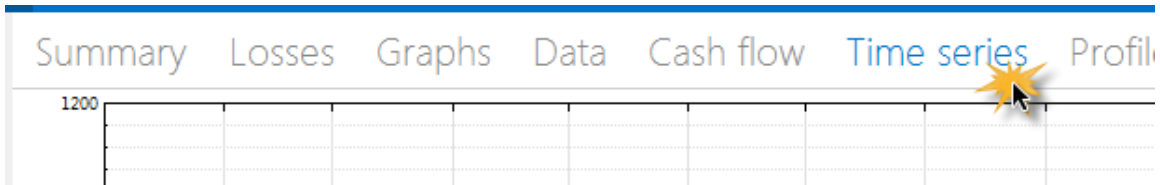
## 31.6 Time Series

Time series data is hourly or subhourly data. It includes time series data from the performance model, and time-dependent pricing data from the financial model.

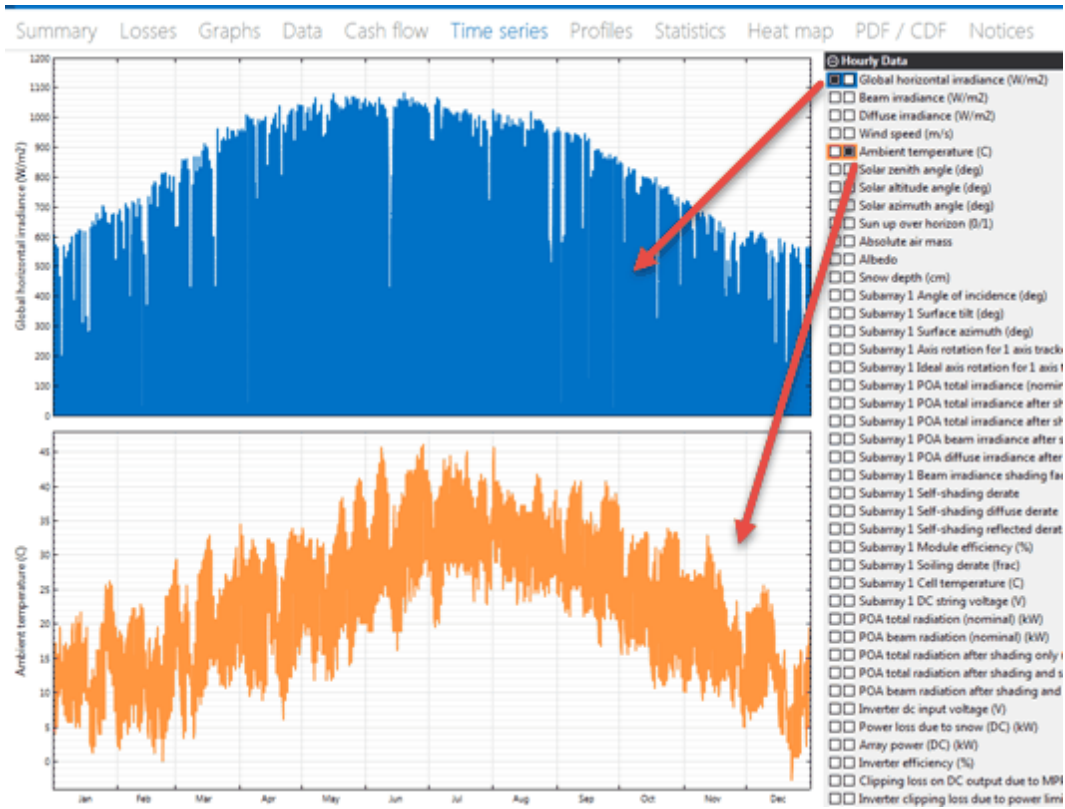
**Note.** SAM's time series data viewer is also available as a standalone application. For details, see [BEopt Download DView](#).

**To view the Time Series graphs:**

1. On the Results page, click the **Time series** tab.



2. Choose variables to display in the graph by checking boxes or choosing from lists as appropriate. The left column of check boxes displays data in the main graph. The right column of check boxes displays data in a secondary graph below the main graph.

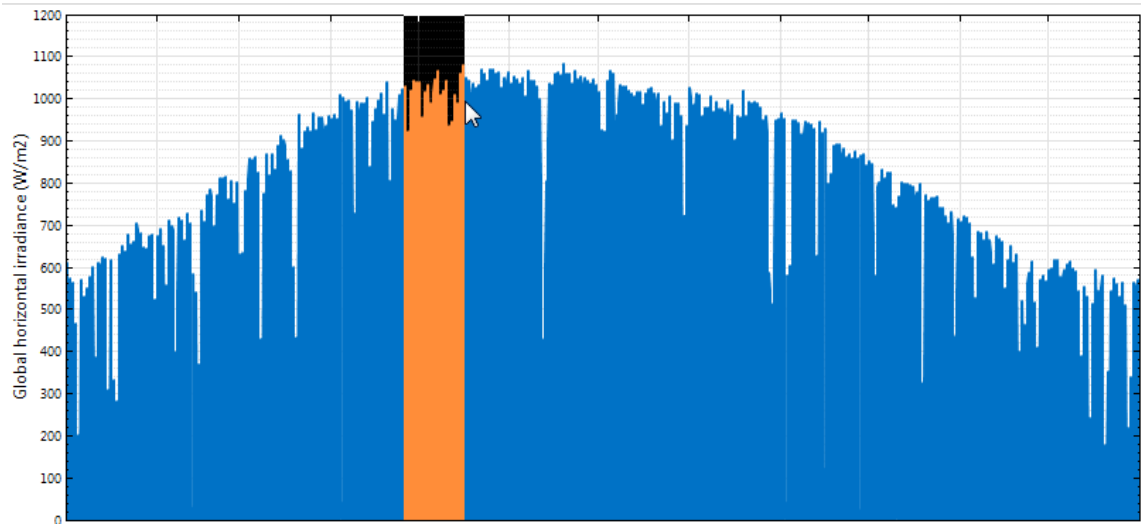


The tool bar below the graphs provides tools for zooming and changing graph settings:



Use your mouse to zoom in to a section of the graph:





### Graph Controls:

- Drag the mouse – zoom in
- Ctrl + Drag – zoom in x direction only by dragging (where applicable)
- Shift + Drag – Pan plot
- Mouse Wheel – zoom plot
- Shift + Mouse Wheel – Scroll plot horizontally
- Ctrl + Mouse Wheel – Scroll plot vertically (where applicable)

### Time Series Graph Types

You can other graphs of time series data:

[Time series](#) [Daily](#) [Profiles](#) [Statistics](#) [Heat map](#) [Scatter](#) [PDF / CDF](#) [Duration curve](#)

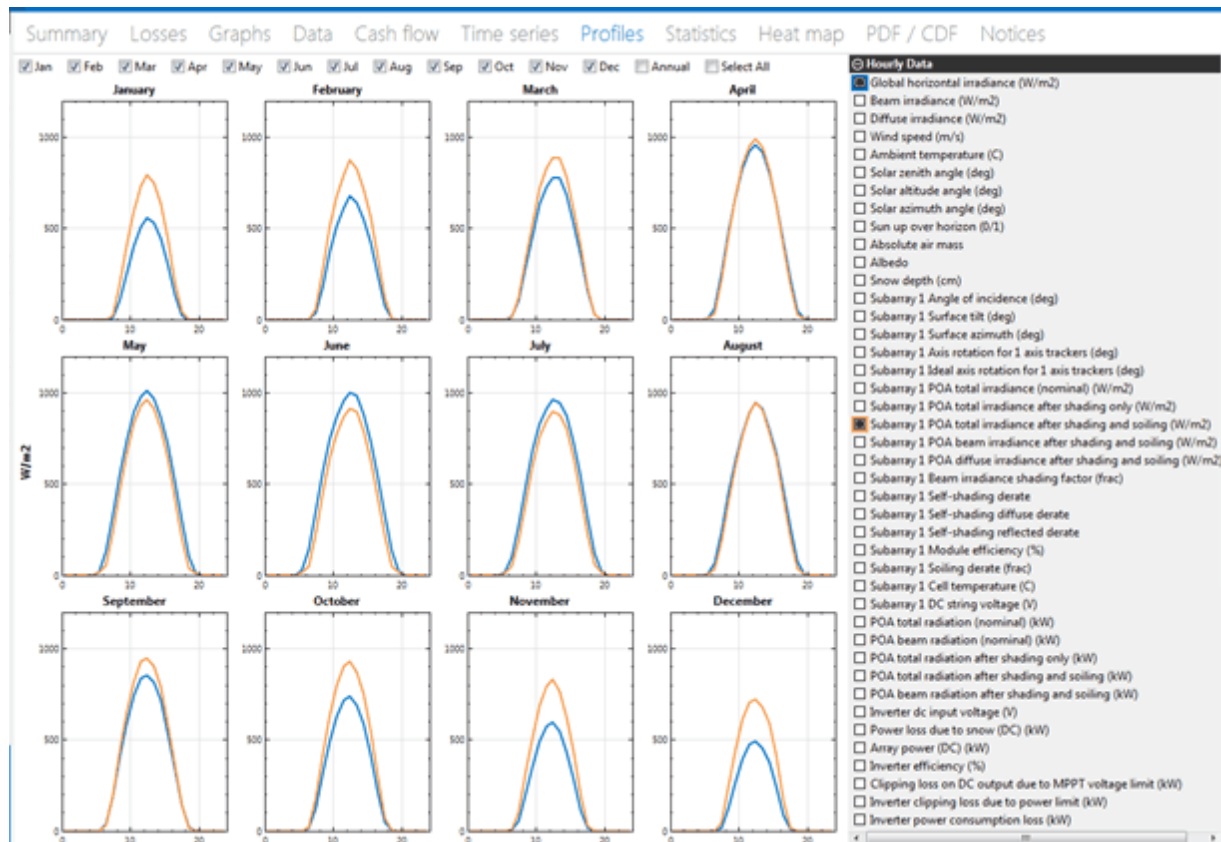
- [Profiles](#)
- [Statistics](#)
- [Heat Map](#)
- [PDF/CDF](#)

## 31.7 Profiles

The **Profile** tab displays time series data as an average daily profile for each month of the year.

- Choose the variables to display in the graphs using the check boxes to the right of the graphs.
- Use the check boxes along the top to choose which months you want to appear. You can also view an annual profile, which is calculated by averaging all of the monthly profiles.

- You can only export an image or data for a single graph at a time. To export an image of all of the graphs, you can use your computer's screen capture tool (Snipping Tool in Windows, Command-Shift-4 in OS X). Resizing the SAM window will resize the graphs.



## 31.8 Statistics

The **Statistics** tab displays statistical summaries of the time series data. You can show mean, minimum, maximum, total, standard deviation, average daily minimum, and average daily maximum over the entire year or by month.

To export data from the table, right-click it (control click on a mouse with one button) and choose an option.

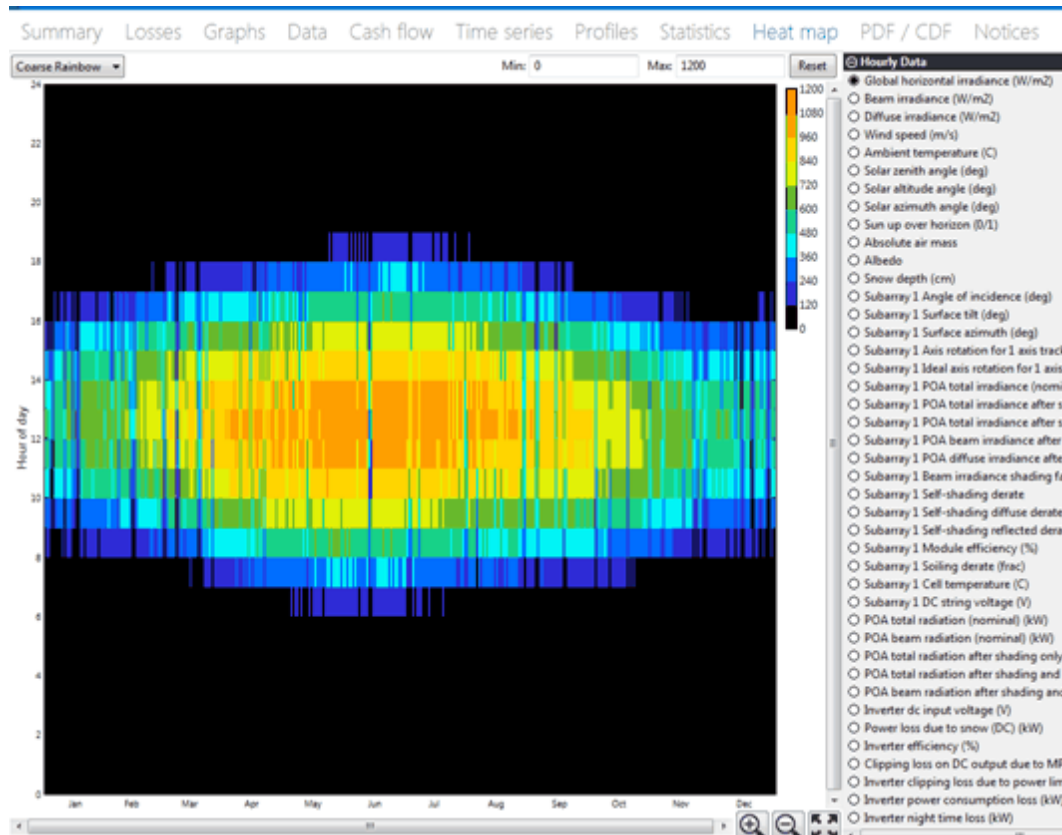
Summary Losses Graphs Data Cash flow Time series Profiles Statistics Heat map PDF / CDF Notices							
Show Monthly Values <input type="checkbox"/>							
	Mean	Min	Max	Sum	Std Dev	Avg Daily Min	Avg Daily Max
<input type="checkbox"/> All							
<input type="checkbox"/> Hourly Data							
<input type="checkbox"/> Global horizontal irradiance (W/m2)							
Jan	135.6717	0	702.2631	100939.7782	210.28	0	561.5375
Feb	179.7972	0	812.1558	120823.7032	255.2539	0	684.9261
Mar	229.9379	0	964.6269	171073.806	309.2661	0	829.4923
Apr	300.3638	0	1041.9037	216261.9457	365.7469	0	968.6697
May	338.5122	0	1076.4558	251853.0479	388.9625	0	1029.9205
Jun	344.9496	0	1079.3973	248363.7458	391.9764	0	1016.3669
Jul	324.7309	0	1063.996	241599.8224	375.4515	0	986.0334
Aug	298.605	0	1024.842	222162.1401	360.4166	0	948.6058
Sep	258.9317	0	962.5117	186430.858	329.7989	0	870.7374
Oct	206.9167	0	848.7105	153945.9999	281.0152	0	744.1318
Nov	151.9363	0	719.9673	109394.1694	221.6298	0	610.5161
Dec	121.6013	0	616.3223	90471.3518	188.6914	0	513.7581
Total	241.2466	0	1079.3973	2113320.3685	324.2729	0	814.1361
<input type="checkbox"/> Beam irradiance (W/m2)							
<input type="checkbox"/> Diffuse irradiance (W/m2)							
<input type="checkbox"/> Wind speed (m/s)							
<input type="checkbox"/> Ambient temperature (C)							

## 31.9 Heat Map

The **Heat Map** tab allows you to see how the data varies by time of day and by time of year on the same graph. The time of year is on the x axis, and the time of day is on the y axis.

Here are some tips for using the heat map:

- Only one variable at a time can be viewed on the heat map.
- Like the [time series](#) graph, the heat map can be scrolled and zoomed. The heat map can zoom in both the x and y directions. You can zoom in both directions at once by highlighting a rectangular region with your mouse. Alternatively, you can use the Ctrl key to zoom in the x direction only.
- The default color map is Coarse Rainbow. The Fine Rainbow color map provides higher color resolution. You can select the color map you want to use in the top left corner.
- Use the **Min** and **Max** inputs to set the maximum and minimum bounds for the color map.
- To export an image of the graph or the graph data, right-click the graph (control-click on a mouse with one button) and choose an option.



## 31.1 PDF / CDF

### 0

The PDF/CDF tab shows the probability density function and cumulative distribution function for a single variable.

The probability density function (PDF) is a histogram that shows the distribution of the variable you choose. You can choose from the following options to determine the number of bins in the histogram. The cumulative distribution function (CDF) shows the percentage of data points at or below a certain value. SAM displays the empirical CDF, which is a step function that increases at each data point, and is flat in between. For a large number of data points, this is a very good approximation to the true CDF.

For the PDF number of bins:

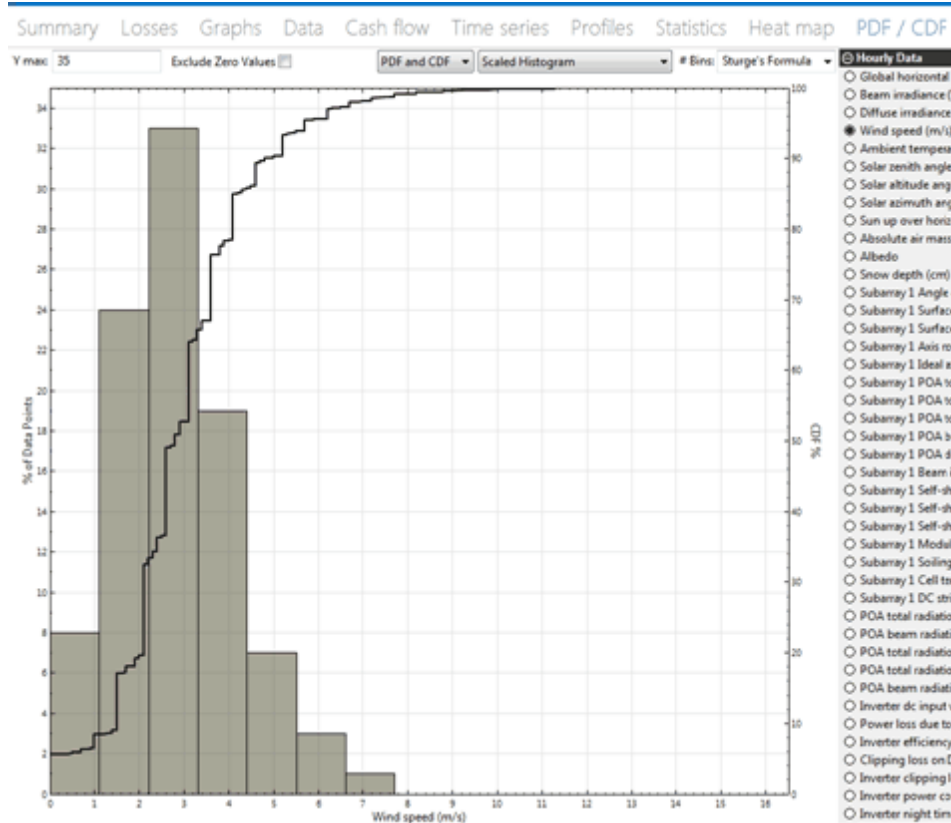
- **Sturge's formula** calculates the number of bins as  $\log_2(n) + 1$ , where  $n$  is the number of data points.  $S$
- **SQRT (Excel)** uses the same method as Microsoft Excel where the number of bins is the square root of the number of data points.
- **20, 50, and 100** set the number of bins to the value you choose.

The scaling options allow you to change the units on the Y axis:

- **Histogram** shows the number of data points in each bin.

- **Scaled histogram** shows each bar height as a percentage of the total number of data points.
- **Scale by bin width** sets bar height so that the total area of the bars is equal to 100%. This is the best approximation of the probability density function since the area under a PDF curve must be equal to one.
- **Y max** sets the maximum value of the y-axis.

To export an image of the graph or the graph data, right-click the graph (control-click on a mouse with one button).



## 31.1 Uncertainties

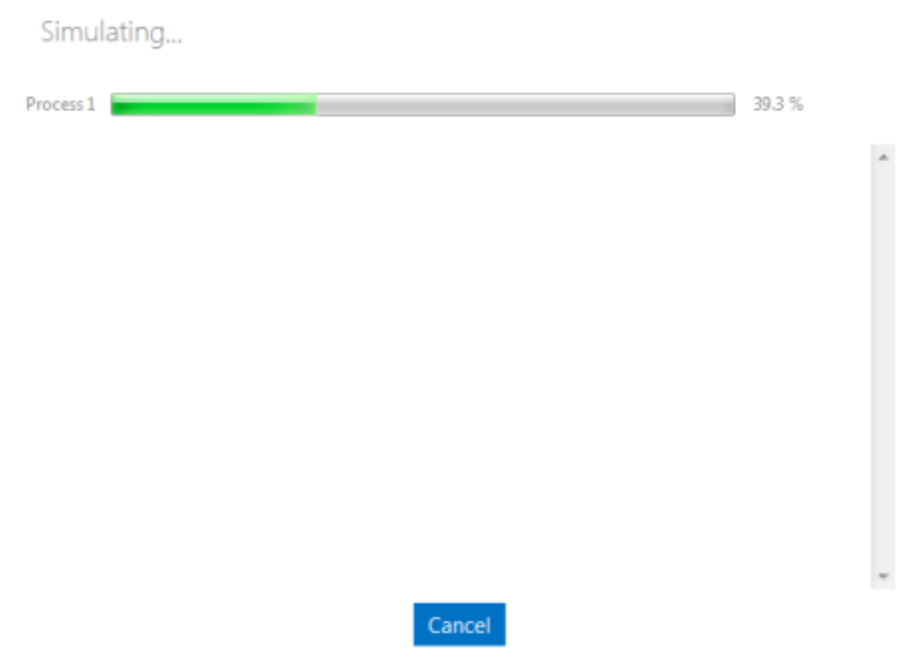
### 1

The Uncertainties tab displays graphs of uncertainty in the wind power model's annual energy output generated from the uncertainty distributions and correlations defined on the [Uncertainties](#) page.

## 31.1 Notices

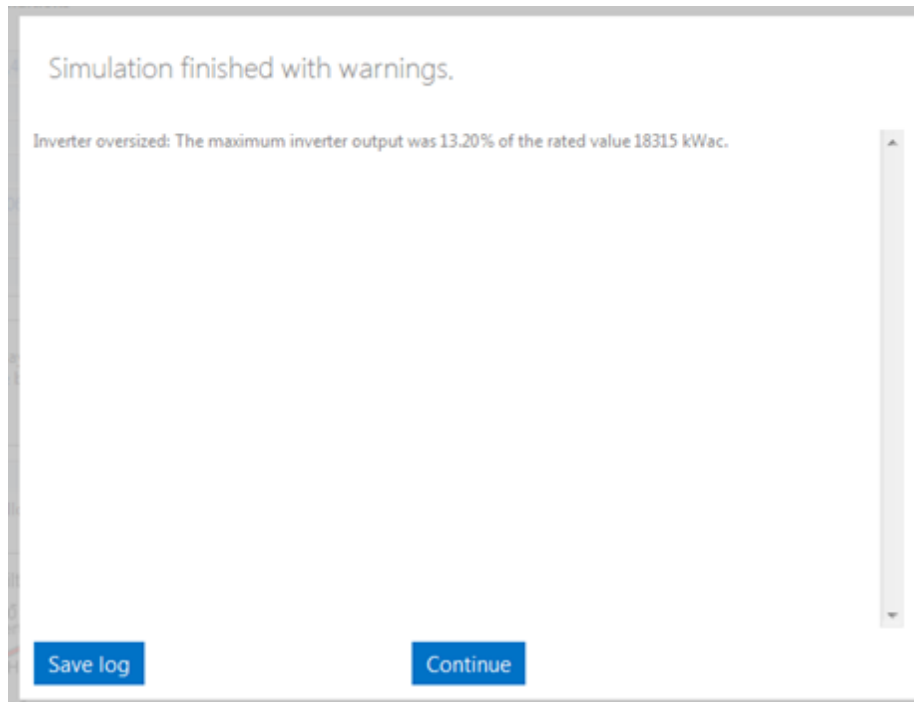
### 2

While the simulation is running, SAM displays a status window that shows the progress of the simulation.



After the simulation is complete, the window displays any simulation errors or warnings. In some cases, the warnings give you information to help you adjust inputs to correct a problem with the case. In other cases, they describe calculation errors or other problems. You can click **Save Log** to save the warning messages to a text file.

**Note.** If you encounter warnings or errors that you do not understand or cannot solve, contact [SAM Support](#) with as much information about the case as you can provide, including the performance and financial model, description of the steps that led to the warning, and the exact text of the warning or error message (sending screenshots is always helpful).



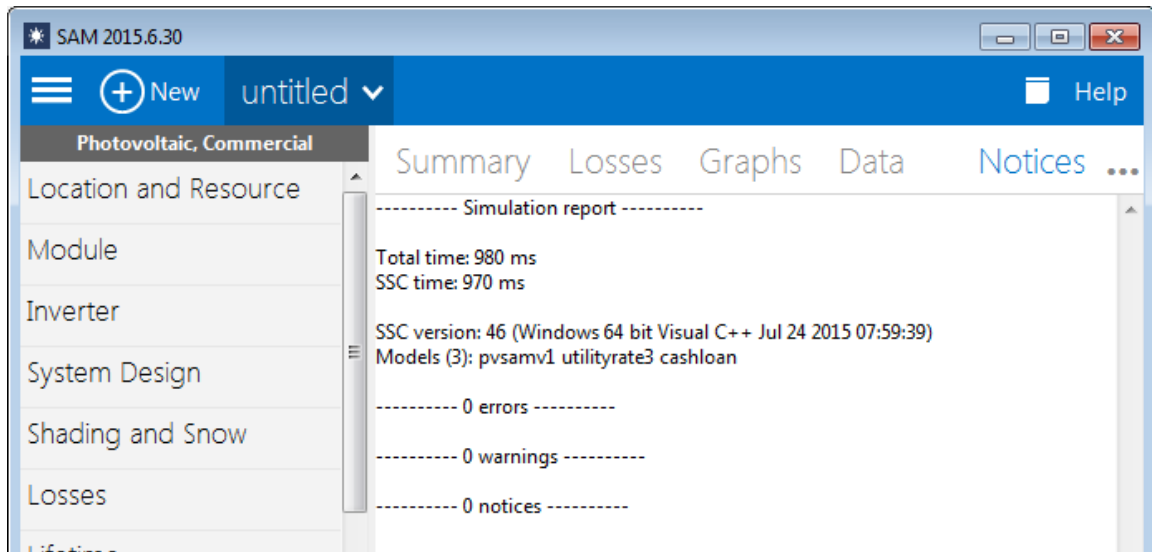
## Notices

The Notices tab displays information about the simulation results:

- An error indicates that the simulation failed. This might be caused by an invalid value for an input variable or combination of variables.
- A warning or notice indicates that the simulation finished, but that there may be a problem with one or more of the input variables. A notice is for less severe problem than a warning.

### To display notices:

- Click the **Notices** tab on the Results page.



## 32 Financial Metrics

The financial metrics are the selection of single-value results from the financial model that appear in the Metrics table on the [Summary](#) page. The financial metrics are calculated from values in the project [cash flow](#).

**Note.** You can find more financial metrics under **Single Value** on the [Data](#) and [Graphs](#) pages.

See [Performance Metrics](#) for a description of results generated by the performance model.



Metric	Value
Annual energy	37,211,968 kWh
Capacity factor	21.2%
First year kWhAC/kWDC	1,861 kWh/kW
Performance ratio	0.78
PPA price (Year 1)	10.33 ¢/kWh
PPA price escalation	1.00 %
Levelized PPA price (nominal)	11.20 ¢/kWh
Levelized COE (nominal)	10.48 ¢/kWh
Net present value	\$2,727,177
Internal rate of return (IRR)	11.00 %
Year IRR is achieved	20
IRR at end of analysis period	12.76 %
Net capital cost	\$41,179,084
Equity	\$19,478,956
Size of debt	\$21,700,130

Performance metrics (rows 1-4)

Financial metrics (rows 5-14)

SAM displays different metrics depending on the [financial model](#) for the case. For example, SAM displays the payback period for the residential and commercial financial model, but not for the PPA models.

In general, you should evaluate financial metrics as a group. For example, for a PPA project, the PPA price, internal rate of return, and net present value (NPV) should all be reasonable: A reasonable PPA price with a negative NPV may indicate a problem with your assumptions or that the project is not financially feasible. SAM displays values for financial metrics even when they indicate a financially non-feasible project because the software cannot tell when such results indicate an infeasible project, or when they indicate a mistake in the inputs. When you see metrics that do not make sense, check your assumptions to make sure you did not make a mistake.

## Additional Resources

You can explore the methodology for some of SAM's financial models by downloading the spreadsheets from the [SAM website](#). Each of the spreadsheets duplicates SAM's cash flow equations using Excel formulas.

For the residential, commercial, and single owner financial models, you can also use the **Send to Excel** button from the [Cash Flow](#) on the Results page to export your project's financial inputs to an Excel workbook with the SAM financial model implemented using Excel formulas.

For more information about the levelized cost of energy (LCOE) and other economic metrics for renewable energy projects, see *Manual for the Economic Evaluation of Energy Efficiency and Renewable Energy Technologies*. (Short 1995) <http://www.nrel.gov/docs/legosti/old/5173.pdf>.

## Residential and Commercial Model Metrics

SAM displays the following metrics on the Summary page for the residential and commercial financial models:

- [Levelized cost of energy \(nominal\)](#)
- [Levelized cost of energy \(real\)](#)
- [Electricity bill without system](#)

- [Electricity bill with system](#)
- [Net savings with system](#)
- [Net present value](#)
- [Payback period](#)
- [Net capital cost](#)
- [Equity](#)
- [Debt](#)

### Residential and Commercial Model Troubleshooting Tips

A very high net present value (NPV) with negative levelized COE values may indicate that Year zero incentives are greater than the project [net capital cost](#). Check that you correctly specified the incentives on the [Incentives](#) page.

A payback period of 1.#INF years indicates that the payback period is longer than the analysis period. It is often accompanied by a negative NPV, and indicates that the value of energy savings is less than the cost of installing the project.

## PPA Model Metrics

### PPA Model Troubleshooting Tips

A negative internal rate of return with negative net present value (NPV) may indicate that project cash flows are insufficient to cover the Year zero investment cost. Check that the costs on the System Costs page are not too high.

An IRR of zero with positive NPV and debt percent greater than 100% for one of the PPA financial models may indicate that the debt funding amount is greater than the project [net capital cost](#). Check that the debt interest rate on the Financial Parameters page is not too low.

The following table shows the financial metrics for the four PPA financial models:

- SO: Single Owner
- LPF: Leveraged Partnership Flip
- AEPF: All Equity Partnership Flip
- SL: Sale Leaseback

Metric	SO	LPF	AEPF	SL
<a href="#">PPA price (year 1)</a>	•	•	•	•
<a href="#">PPA price escalation</a>	•	•	•	•
<a href="#">Levelized PPA price (nominal)</a>	•	•	•	•
<a href="#">Levelized cost of energy (nominal)</a>	•	•	•	•
<a href="#">Net present value</a>	•			
<a href="#">Internal rate of return (IRR)</a>	•			
<a href="#">Year IRR is achieved</a>	•			
<a href="#">IRR at end of analysis period</a>	•			
<a href="#">Investor IRR (after-tax)</a>		•	•	•
<a href="#">Year investor IRR achieved</a>		•	•	•

<a href="#">Investor NPV (after-tax)</a>		•	•	•
<a href="#">Developer IRR (after-tax)</a>		•	•	•
<a href="#">Developer NPV (after-tax)</a>		•	•	•
<a href="#">Net capital cost</a>	•	•	•	•
<a href="#">Equity</a>	•	•	•	•
<a href="#">Size of debt</a>	•	•		
<a href="#">Minimum DSCR</a>	•	•		

## 32.1 Debt and Equity

The debt and equity metrics show the amount borrowed and initial cash investment amount for financial models with project term debt. The all equity partnership flip and sale leaseback models do not include debt.

### Equity

For projects with term debt, equity is the amount of cash invested by the project owner or investor:

$$\text{Equity (\$)} = \text{Net capital cost (\$)} - \text{Debt (\$)}$$

### Debt

For projects with term debt, debt is the amount borrowed by the project. How SAM calculates the debt amount depends on the financial model.

### Residential and Commercial

For the residential and commercial financial models, size of debt depends on the debt percent and [net capital cost](#):

$$\text{Debt} = \text{debt percent (\%)} \times \text{net capital cost (\$)}$$

Where the debt percent is from the Financial Parameters page, and the net capital cost is the total installed cost less cash incentives.

### Single Owner and Leveraged Partnership Flip

For the single owner and leveraged partnership flip financial models, on the [Financial Parameters](#) page, you can either specify the debt size as a fraction of [net capital cost](#), or specify a debt-service coverage ratio.

#### Debt Fraction Input

When you specify the debt percent as an input, SAM assumes constant debt payments, and reports the debt size as a fraction of the [net capital cost](#):

$$\text{Debt} = \text{debt percent (\%)} \times \text{net capital cost (\$)}$$

The minimum DSCR is the smallest annual debt service coverage ratio from the cash flow, where:

$$\text{DSCR in Year } n = \text{cash available for debt service in Year } n \div \text{Total P\&I payment in Year } n$$

### DSCR Input

When you specify the DSCR as an input, SAM calculates annual based on the project's annual revenue and expenses assuming a constant annual DSCR. SAM calculates the debt funding amount from the cash available for debt service (CAFDS) in the [cash flow](#), and the term debt interest rate  $r$  and constant DSCR from the Financial Parameters page:

$$\text{Debt} = \sum_{n=1}^N \frac{\text{CAFDS}_n}{(1+r)^n \text{DSCR}}$$

### Cash Available for Debt Service

The cash available for debt service (CAFDS) depends on project revenue, expenses, and equipment reserve funding:

$$\text{CAFDS in Year } n = \text{EBIDTA in Year } n - \text{total equipment reserve funding in Year } n$$

Where EBIDTA is the project's net pre-tax earnings and equipment reserve funding are from the cash flow:

- [Single Owner cash flow](#)
- [Leveraged Partnership Flip cash flow](#)

## 32.2 Electricity Bill and Savings

For the residential and commercial financial models, SAM assumes that electricity generated by the power system displaces purchases of electricity from the grid to meet a building or facility electric load. You specify the electricity rates on the [Electricity Rates](#) page, and the load on the [Electric Load](#) page.

SAM calculates the total annual electricity bill for two scenarios, one with and one without the power system, and then calculates the net savings as the difference between the two. SAM assumes the same electric load and electricity rate structure for both scenarios.

**Notes.** The electricity bill and savings values in the Metrics table are for Year one of the project cash flow. For a description of how to display annual, monthly, and hourly values, see [Retail Electricity Savings](#).

#### Electricity bill without system, \$/year

The total annual cost of electricity that would be purchased to meet the building or facility electric load and charge the battery with no power system.

#### Electricity bill with system, \$/year

The the total annual cost of electricity purchased from the grid, assuming that the project purchases electricity for hours when the load is greater than system's output, or to charge the battery.

#### Net savings with system, \$/year

The difference between costs without system and with system:

$$\text{Net Savings} = \text{Cost without System} - \text{Cost with System}$$

**Note.** Net savings with system is equal to [Energy Value](#) for Year one of the project cash flow.

### 32.3 Indifference Point

The [Third Party - Host / Developer](#) financial model calculates the host indifference point, which quantifies host's annual electricity bill from the utility with out the renewable energy system as a rate per unit of electricity (\$/kWh), accounting for the host's electricity rate structure and consumption. The indifference point is the maximum power purchase agreement (PPA) price that makes the PPA more cost effective to the host than purchasing power from the utility: The host is unlikely to accept a PPA if the developer offers a PPA price that is greater than the indifference point. Like the [PPA price](#), SAM reports the Year 1, nominal levelized, and real levelized indifference point. Be sure to compare the same form of the indifference point and PPA price.

The host indifference point in each year is the [electricity savings](#) divided by the total renewable energy production:

$$\text{Host Indifference Point in Year } n = \text{Electricity Savings in Year } n / \text{Annual Energy in Year } n$$

The levelized host indifference point is the present value of the annual values.

**Note.** The variable name for the indifference point is "NTE," which stands for "not to exceed" because the indifference point can also be thought of as the value the PPA price is not to exceed.

### 32.4 Internal Rate of Return (IRR)

The internal rate of return is the *nominal* discount rate that corresponds to a net present value (NPV) of zero for the PPA financial models.

$$NPV = \sum_{n=0}^N \frac{C_n}{(1 + IRR)^n} = 0$$

Where  $C_n$  is the after-tax cash flow.

You choose a solution mode on the [Financial Parameters](#) page that determines whether SAM calculates the IRR to meet a desired PPA price that you specify, or calculates a PPA price to meet a desired target IRR that you specify:

- When the solution mode is **Specify IRR target**, you specify a desired IRR and the year you want the IRR to be achieved. SAM adjusts the PPA price until the IRR in that year is as close as possible to the IRR target.
- When the solution mode is **Specify PPA price**, SAM calculates the IRR that results from the PPA price you specify. You can specify the year to achieve the IRR to display the IRR for that year in the Metrics table.

For the single owner financial model, the IRR and year it is achieved is from the owner's perspective. For the leveraged partnership flip, all equity partnership flip, and sale leaseback financial models that involve two project partners, SAM reports the IRR from the perspective of each partner, and the year in which the investor's IRR is achieved.

**Note.** If you try to replicate the IRR equation in Excel or other spreadsheet software by exporting the cash flow table and using the NPV formula on the appropriate after-tax cash flow row, you may find that the IRR value that SAM calculates does not appear to result in an NPV of zero. (It will always be close to zero compared to the magnitude of the cash flows.) This is because SAM reports the IRR to four significant digits, and for projects with large cash flows, a higher accuracy may be required to show the value that results in an NPV closer zero. For example, for a \$74 million project with average annual after-tax cash flows of \$3.9 million, SAM reports an IRR of 22.56% in the [Metrics table](#), and 22.5589 in [Tables](#). In Excel, the formula =NPV(0.2256,B60:AF60) results in an NPV of -\$573.96 dollars, while the formula =(0.225589632,B60:AF60) results in an NPV value of -\$0.02. For this example, it would be reasonable to consider the IRR to be 22% or 23%.

### Year IRR is Achieved

When you specify either a PPA price or target IRR on the Financial Parameters page, you also specify the year in which you want the IRR to be achieved. SAM calculates an IRR value for each year in the analysis period (see [cash flow](#)). The year the IRR is achieved is as close as possible to the target year that you specify on the Financial Parameters page.

### IRR at End of Analysis Period

The single owner financial model reports the IRR at the end of the analysis period in addition to the IRR in the target year.

## 32.5 Levelized Cost of Energy (LCOE)

The levelized cost of energy (LCOE) is the total project lifecycle cost expressed in cents per kilowatt-hour of electricity generated by the system over its life.

The LCOE includes the following costs:

- The project equity investment: Equipment and labor costs, construction period financing costs, project development and financing fees, and sales tax less the size of debt (amount borrowed).
- Operating expenses, including for operation and maintenance, insurance payments, and property taxes.
- Project term debt costs: Principal and interest payments, and funding of debt service reserve account.
- Funding of and disbursement reserves: Working capital, equipment replacement, and debt service
- State and federal tax liability.

The levelized cost includes the following benefits:

- State and federal tax benefits: Depreciation, tax credits, deductible expenses, deductible debt interest payments.
- Interest earned on reserve accounts.
- Cash incentives: Investment-based, capacity-based, and production-based incentives.

- Salvage value

The levelized cost in SAM depends on the following assumptions:

- The quantity of electricity generated by the system for each year in the analysis period, shown as [Energy](#) in the [cash flow](#) table. The performance model calculates the annual energy for Year one based on the hourly simulations. SAM adjusts this value by the factors that you specify on the [Lifetime](#) page.
- Installation and operating costs on the [System Costs](#) page
- Financial assumptions on the [Financial Parameters](#) page
- Incentives on the [Incentives](#) page
- Depreciation assumptions on the [Depreciation](#) page

**Note.** For the Residential and Commercial financial models, the retail electricity prices from the [Electricity Rates](#) page do not affect the levelized cost. The levelized cost is a measure of the cost of installing and operating the system, not of the value of electricity purchases avoided by the system. The project [NPV](#) is a measure of both the project costs and energy value.

To use the levelized cost for evaluating project options, it must be comparable to cost per energy values for alternative options:

- For the residential or commercial models, SAM assumes that the renewable energy system meets all or part of a building's electric load, so the levelized cost is comparable to a \$/kWh retail electricity rate representing cost of the alternative option to meet all the building's load by purchasing electricity from the grid at retail rates. To be economically viable, the project's levelized cost must be equal to or less than the average retail electric rate.
- For the PPA models, SAM assumes that the project sells all of the electricity generated by the system at a price negotiated through a power purchase agreement (PPA). For these projects the levelized cost is comparable to the [levelized PPA price](#). A financially viable project is likely to have a levelized cost that is equal to or less than the levelized PPA price to cover project costs and meet [internal rate of return](#) requirements.

The levelized cost should be considered with the other financial metrics to evaluate a project's financial feasibility. For example, a financially feasible project is likely to have a positive net present value (NPV) given the discount rate you assume, reasonable capacity factor, and depending on the financial model, a reasonable payback period, internal rate of return, size of debt, etc.

## Real and Nominal Levelized Cost

For all financial models, SAM calculates both a real and nominal levelized cost values. The real levelized cost is a constant dollar, inflation-adjusted value. The nominal LCOE is a current dollar value.

The choice of real or nominal LCOE depends on the analysis. Real (constant) dollars may be appropriate for long-term analyses to account for many years of inflation over the project life, while nominal (current) dollars may be more appropriate for short-term analyses.

Some industries prefer to use one form over the other. For example, when discussing LCOE for parabolic trough projects, analysts have tended to use the nominal LCOE (see [Current and Future Costs for Parabolic Trough and Power Tower Systems in the US Market](#)), while the U.S. Department of Energy has used the real LCOE in its comparative analysis of photovoltaic project costs ([Solar Energy Technologies Program Multi-Year Program Plan 2007-2011](#)).

Be sure to use the same form of the LCOE when comparing costs for different alternatives: Never compare a real LCOE of one alternative with a nominal LCOE of another.

## Levelized Cost Equations

For the real levelized cost, the real discount rate appears in the denominator's total energy output term:

$$\text{Levelized cost (real)} = \frac{-C_0 - \frac{\sum_{n=1}^N C_n}{(1 + d_{\text{nominal}})^n}}{\frac{\sum_{n=1}^N Q_n}{(1 + d_{\text{real}})^n}}$$

Similarly, for the nominal levelized cost, the nominal discount rate appears in the denominator's total energy output term:

$$\text{Levelized cost (nominal)} = \frac{-C_0 - \frac{\sum_{n=1}^N C_n}{(1 + d_{\text{nominal}})^n}}{\frac{\sum_{n=1}^N Q_n}{(1 + d_{\text{nominal}})^n}}$$

Where,

- $Q_n$  (kWh) Electricity generated by the system in year  $n$  shown in the [Energy](#) row in the project [cash flow](#). The performance model calculates this value based on [weather data](#) and system performance parameters.
- $N$  Analysis period in years as defined on the [Financial Parameters](#) page
- $C_0$  The project's [equity](#) investment amount.
- $C_n$  The annual project costs in Year  $n$ , as listed under costs and benefits above.
- $d_{\text{real}}$  The real discount rate defined on the [Financial Parameters](#) page. This is the discount rate without inflation. See [LCOE Definition](#) for an explanation of discount rates in the LCOE calculation.
- $d_{\text{nominal}}$  The nominal discount rate shown on the Financial Parameters page. This is the discount rate with inflation.

## Levelized Cost Definition

This description of the levelized cost of energy uses the vocabulary and equations described in the *Manual for the Economic Evaluation of Energy Efficiency and Renewable Energy Technologies*. (Short 1995) <http://www.nrel.gov/docs/legosti/old/5173.pdf>.

By definition, a project's annual cost  $C_n$  is the product of the LCOE and the quantity of electricity generated by the system in that year,  $Q_n$ :

$$C_n = Q_n \times LCOE$$

Project costs  $C_n$  include installation, operation and maintenance, financial costs and fees, and tax benefit or liability, and also account for incentives and salvage value. SAM's performance model calculates the annual energy  $Q_n$  for  $n = 1$ . For  $n > 1$ ,  $Q_n$  decreases from year to year if the **degradation rate** on the [Lifetime](#) page is greater than zero. Otherwise, the annual energy is constant over the analysis period.

The project's total lifecycle cost (*TLCC*) is the present worth of project costs over the analysis period  $N$  discounted at rate  $d$ :



$$TLCC = \sum_{n=0}^N \frac{C_n}{(1+d)^n}$$

Substituting the cost equation for  $C_n$ :

$$\sum_{n=1}^N \frac{Q_n \times LCOE}{(1+d)^n} = TLCC$$

Combining the two equations above gives:

$$\sum_{n=1}^N \frac{Q_n \times LCOE}{(1+d)^n} = \sum_{n=0}^N \frac{C_n}{(1+d)^n}$$

#### Notes.

The annual cost  $C_n$  includes the effect of inflation, so the nominal discount rate is the correct form to use on the right side of the equation.

The correct form of the discount rate on the left side of the equation depends on whether the LCOE is a real or nominal value.

The summation in the left hand term begins at  $n = 1$ , which is the first year that the system produces energy. The right hand summation begins at  $n = 0$  to include investment costs in the calculation.

Solving for LCOE gives:

$$LCOE = \frac{\sum_{n=0}^N \frac{C_n}{(1+d)^n}}{\sum_{n=1}^N \frac{Q_n}{(1+d)^n}}$$

**Note.** This equation makes it appear that the energy term in the denominator is discounted. That is a result of the algebraic solution of the equation, not an indication of the physical performance of the system.

## 32.6 Levelized PPA price

The levelized revenue represents the monetary value of the project over its life. It is the present value of the project's PPA revenue expressed in cents per kilowatt-hour of electricity generated by the system.

The project's PPA revenue is revenue from electricity sales at the [PPA price](#) with an optional [annual escalation rate](#). The PPA price may be fixed, or it may come with a set of [time of delivery factors](#) to adjust it based on time of day and year. (PPA revenue does not include salvage value or production-based incentives.)

In general, the levelized nominal PPA price should be greater than the levelized nominal cost for a financially feasible project. As with the other financial metrics, always evaluate the metrics as a group: A financially

feasible project should also have a positive [net present value \(NPV\)](#), and reasonable [debt size](#), [PPA price](#), and [internal rate of return](#).

## Equations for Levelized Revenue Calculations

SAM uses the real and nominal discount rates from the [Financial Parameters](#) page to calculate the present value of future annual revenue values.

### Notes.

For a brief discussion of when to use nominal and real levelized values, see [Real and Nominal Levelized Cost](#).

The energy term in the denominator of the equations below appears to be discounted because of the algebraic solution of the definition of the levelized price. See [Levelized Cost Equations](#) for details.

For the nominal levelized revenue, the nominal discount rate appears in the total energy output term:

$$\text{Levelized PPA price (nominal)} = \frac{\frac{\sum_{n=1}^N R_n}{(1 + d_{\text{nominal}})^n}}{\frac{\sum_{n=1}^N Q_n}{(1 + d_{\text{nominal}})^n}}$$

Similarly, for the real levelized revenue (available on the [Data](#) page, under **Single Values**), the real discount rate appears in the denominator's total energy output term:

$$\text{Levelized PPA price (real)} = \frac{\frac{\sum_{n=1}^N R_n}{(1 + d_{\text{nominal}})^n}}{\frac{\sum_{n=1}^N Q_n}{(1 + d_{\text{real}})^n}}$$

Where,

$Q_n$  (kWh) Electricity generated by the project in year  $n$ , calculated by the performance model based on weather data and system performance parameters. The first year output is reported in the Metrics table on the [Summary](#) page and in the year one column of the project [cash flow](#). Year two and subsequent output is the first year output reduced by the amount specified for the **degradation rate** on the [Lifetime](#) page.

$N$  Analysis period in years as defined on the [Financial Parameters](#) page.

$R_n$  PPA revenue from electricity sales in year  $n$  as defined above.

$d_{\text{real}}$  The real discount rate defined on the [Financial Parameters](#) page. This is the discount rate without inflation. See [LCOE Definition](#) for an explanation of discount rates in the levelized cost and PPA price calculation.

$d_{\text{nominal}}$  The nominal discount rate shown on the Financial Parameters page. This is the discount rate with inflation.

## 32.7 Net Present Value (NPV)

A project's net present value (NPV) is a measure of a project's economic feasibility that includes both revenue (or savings for residential and commercial projects) and cost. In general, given the discount rate you assume, a positive NPV indicates an economically feasible project, while a negative NPV indicates an economically infeasible project. You should evaluate the NPV along with other metrics including capacity factor, internal rate of return, PPA price, payback period, size of debt, etc.

For more information about using the NPV and other economic metrics to evaluate renewable energy projects, see pages 39-42 of Short W et al, 1995. *Manual for the Economic Evaluation of Energy Efficiency and Renewable Energy Technologies*. National Renewable Energy Laboratory. NREL/TP-462-5173. <http://www.nrel.gov/docs/legosti/old/5173.pdf>

The NPV is the present value of the after tax cash flow discounted to year one using the nominal discount rate:

$$NPV = \sum_{n=0}^N \frac{C_n}{(1 + d_{nominal})^n}$$

Where  $C_n$  is the after-tax cash flow in Year  $n$  for the residential and commercial models, and the after-tax project returns for the PPA models,  $N$  is the analysis period in years that you specify on the [Financial Parameters](#) page, and  $d_{nominal}$  is the nominal discount rate from the Financial Parameters page.

## 32.8 Payback Period

The payback period is the time in years that it takes for cumulative annual savings to equal the cumulative annual costs. The simple payback period accounts for the value of electricity generated by the system, installation and operating costs, incentives, income taxes and depreciation, and debt-related costs. The discounted payback period also accounts for the time value of money by using cash flows discounted at the nominal discount rate from the Financial Parameters page.

The payback period works best for evaluating the economic viability of a project when cash flows are regular. It does not work well for cash flows that include one-time or irregularly-timed costs such as equipment replacements or other investments that occur in a specific year that may fall after the payback year. It also does not work with cash or tax incentives that change over the life of the project, such as income tax holidays or incentive payments over a few years. The [net present value \(NPV\)](#) accounts for all costs and benefits of a project, regardless of when they occur during the project life, and is generally a better metric for evaluating a project's economic viability.

**Notes.**

SAM calculates the payback period for commercial and residential projects only.

A payback period of "NaN" indicates that the payback period is greater than the analysis period. A negative payback period indicates that the sum of IBI and CBI incentives is greater than the project's net capital cost.

You can reduce the payback period by decreasing the installation cost, increasing cash incentives (IBI or CBI amounts), increasing tax savings, or decreasing operating expenses.

SAM's payback calculation is based on the descriptions of simple payback and discounted payback in Short W et al, 1995. *Manual for the Economic Evaluation of Energy Efficiency and Renewable Energy Technologies.* National Renewable Energy Laboratory. NREL/TP-462-5173. <http://www.nrel.gov/docs/legosti/old/5173.pdf>

You can download workbooks that replicate SAM's payback period calculation from the [Financial Models](#) page on the SAM website. For Windows versions of SAM, you can click **Send to Excel with Equations** from the [Cash Flow](#) tab of the Results page to generate an Excel workbook that replicates the payback calculation.

## Cash Flow for Simple Payback Calculation

SAM uses the values from the [cash flow](#) described below to calculate the payback period. The payback period is the year when the cumulative sum of the annual savings is greater than the cumulative sum of annual payback cash flows.

For residential projects:

$$\text{Savings in Year } n > 0 = \text{Value of Electricity Savings in Year } n > 0$$

For commercial projects:

$$\text{Savings in Year } n > 0 = \text{Value of Electricity Savings in Year } n > 0 \times (1 - \text{Effective Tax Rate})$$

For the purposes of calculating the payback period, the cash flow (CF) in Year zero is the net capital cost, and is equal to the sum of investment-based incentive (IBI) and capacity-based incentive (CBI) [amounts](#) specified on the [Incentives](#) page, less the total installed cost from the [System Costs](#) page. A negative value indicates a net outflow:

$$\begin{aligned} \text{CF for payback in Year } n=0 = & \\ & \text{Total IBI} \\ & + \text{Total CBI} \\ & - \text{Total Installed Cost} \end{aligned}$$

**Note.** If you specify that the IBI and CBI are taxable incentives on the Cash Incentives page, the incentives reduce the Year zero cost, but increase the Year one taxes (reducing the tax savings). In some cases, if you increase the IBI and CBI amounts, you may not see the reduction in payback period that you expect.

For the residential standard loan option:

$$\text{CF for payback in Year } n > 0 =$$

*Value of electricity savings*  
 + *State Tax Savings*  
 + *Federal Tax Savings*  
 + *Total PBI*  
 - *Total Operating Expenses*

For the residential mortgage option, debt interest payments are tax deductible and are included in the state and federal tax savings amounts, so SAM subtracts tax on debt to remove the effect of debt from the payback period equation:

*CF for payback in Year  $n>0$  =*  
*Value of electricity savings*  
 + *State Tax Savings*  
 + *Federal Tax Savings*  
 + *Total PBI*  
 - *Debt Interest Payment  $\times$  Effective Tax Rate*  
 - *Total Operating Expenses*

For commercial projects, both the energy value and debt interest payments are tax deductible:

*CF for payback in Year  $n>0$  =*  
*Value of electricity savings  $\times$  (1 - Effective Tax Rate)*  
 + *State Tax Savings*  
 + *Federal Tax Savings*  
 + *Total PBI*  
 - *Debt Interest Payment  $\times$  Effective Tax Rate*  
 - *Total Operating Expenses*

The effective tax rate is a single number that includes both the federal income tax rate and state income tax rate:

*Effective Tax Rate = Federal Tax Rate  $\times$  (1 - State Tax Rate) + State Tax Rate*

The federal and state tax rates are input variables on the [Financial Parameters](#) page.

## Cash Flow for Discounted Payback Calculation

For the discounted payback, the cash flow for calculating payback is discounted at the nominal discount rate:

*CF for discounted payback in Year  $n=0$  = CF for payback in Year  $n=0$*   
*CF for discounted payback in Year  $n>0$  = CF for payback in Year  $n>0$  / ( 1 + Nominal Discount Rate / 100% ) ^ n*

## Payback Period and Debt

As described above, the payback period depends on the project investment cost (sum of IBI and CBI minus total installed cost).

For projects with debt financing, the loan parameters specified on the [Financial Parameters](#) page do not affect the payback period because:

- The loan amount does not affect the project total installed cost or the value of IBI or CBI.
- The *Debt Interest Payment  $\times$  Effective Tax Rate* term in the cash flow equations above effectively remove the tax on debt interest from the payback period calculation for Years One and later. As the

cash flow equations for [State](#) and [Federal](#) income tax show, the tax on debt interest is included in the tax savings amounts. SAM subtracts the amount from the payback cash flow equation to remove the effect of debt from the payback period equation.

## 32.9 PPA Price

The PPA price is the power purchase price for the PPA financial models. SAM assumes that these projects sell electricity at a price negotiated through a power purchase agreement (PPA).

**Note.** When you specify a [PPA price escalation](#) rate on the [Financial Parameters](#) page, the PPA price increases from year to year. The PPA price does not increase with inflation.

The PPA price in the Metrics table is either the value that you specify as an input on the Financial Parameters page, or a value that SAM calculates based on the target internal rate of return (IRR) that you specify.

- When the solution mode on the [Financial Parameters](#) page is **Specify PPA Price**, the Year one PPA price in the Metrics table is the value that you specify.
- When the solution mode is **Specify IRR Target**, SAM determines the PPA price required for project revenues to meet the internal rate of return target that you specify on the Financial Parameters page.

The Year one PPA price that SAM reports in the Metrics table is equivalent to the bid price in a power purchase agreement.

The PPA price is just one measure that is useful for determining whether a project is financially feasible. For example, a project that meets your target IRR with a reasonable PPA price may not be feasible if the net present value (NPV) is negative, or if the size of debt is not within the range that the project can realistically expect to receive a loan.

### PPA Price and TOD Factors

[Time-of-delivery \(TOD\) factors](#) allow the power price to vary with time within the structure of a power purchase agreement with a single bid price. The agreement consists of a PPA price and a set of PPA price multipliers and the periods to which they apply.

For analyses involving PPA price time-of-delivery (TOD) factors, for each hour of the year, SAM multiplies the PPA bid price by the TOD factor to calculate the power price in that hour.

## 32.1 PPA Price Escalation

### 0

The PPA escalation rate is an annual escalation rate that SAM uses to calculate the [PPA price](#) in Years Two and later of the cash flow:

$$PPA \text{ Price in Year } n > 1 = PPA \text{ Price in Year } n = 1 \times ( 1 + PPA \text{ Price Escalation } ) ^ n$$

The PPA escalation rate is an input that you specify on the [Financial Parameters](#) page. SAM does not apply the inflation rate to the PPA price.

## 32.1 Net Capital Cost

### 1

The net capital cost is total installed cost from the [System Costs](#) page less any cash investment-based and capacity-based incentives from the [Incentives](#) page and plus any additional financing costs and fees from the [Financial Parameters](#) page. The exact equation depends on the financial model as described below.

#### Residential and Commercial

For the residential and commercial models, the net capital cost is the total installed cost from the System Costs page:

$$\begin{aligned} \text{Net capital cost} &= \text{total installed cost} \\ &\quad - \text{total IBI} \\ &\quad - \text{total CBI} \end{aligned}$$

#### PPA Models

For the PPA financial models, the net capital cost is the sum of the total installed cost, financing costs and development fees, and debt service and working capital reserve account funding less investment-based incentives:

$$\begin{aligned} \text{Net capital cost} &= \text{total installed cost} \\ &\quad + \text{financing costs and fees} \\ &\quad + \text{debt service reserve funding} \\ &\quad + \text{working capital reserve funding} \\ &\quad - \text{total IBI} \\ &\quad - \text{total CBI} \end{aligned}$$

#### Costs and Fees

Costs and fees are costs that you specify on the Financial Parameters page. SAM adds these costs to the total installed cost on the System Costs page to calculate the net capital cost for the PPA financial models:

##### Single Owner

For the single owner model, costs and fees include debt costs, construction financing cost, and debt and equipment replacement reserves.

$$\begin{aligned} \text{Financing costs and fees} &= \text{debt closing cost} \\ &\quad + \text{debt up-front fee percentage} \times \text{debt} \\ &\quad + \text{financing cost} \\ &\quad + \text{debt service reserve funding} \\ &\quad + \text{construction financing cost} \\ &\quad + \text{major equipment replacement reserve} \end{aligned}$$

You can see these values in the [cash flow](#) under "Cash Flows from Investing Activities."

### Leveraged Partnership Flip

For the leveraged (with debt) partnership flip model, costs and fees include debt costs, construction financing cost, debt and equipment replacement reserves, and development and equity costs.

$$\begin{aligned} \text{Financing costs and fees} &= \text{debt closing cost} \\ &+ \text{debt up-front fee percentage} \times \text{debt} \\ &+ \text{other financing cost} \\ &+ \text{debt service reserve} \\ &+ \text{construction financing cost} \\ &+ \text{major equipment replacement reserve} \\ &+ \text{development fee percentage} \times \text{total installed cost} \\ &+ \text{equity closing cost} \end{aligned}$$

### All Equity Partnership Flip

For the all equity (without debt) leveraged partnership flip model, costs and fees include construction financing cost, debt and equipment replacement reserves, and development and equity costs.

$$\begin{aligned} \text{Financing costs and fees} &= \text{other financing cost} \\ &+ \text{construction financing cost} \\ &+ \text{major equipment replacement reserve} \\ &+ \text{development fee percentage} \times \text{total installed cost} \\ &+ \text{equity closing cost} \end{aligned}$$

### Sale Leaseback

For the all sale leaseback model, costs and fees include construction financing cost, debt and equipment replacement reserves, development and equity costs, and the lease payment reserve.

$$\begin{aligned} \text{Financing costs and fees} &= \text{other financing cost} \\ &+ \text{construction financing cost} \\ &+ \text{major equipment replacement reserve} \\ &+ \text{development fee percentage} \times \text{total installed cost} \\ &+ \text{equity closing cost} \\ &+ \text{lease payment reserve} \end{aligned}$$

## 33 Performance Metrics

The performance metrics are values that SAM calculates from the hourly performance model results and, for some variables such as capacity factor, the system specifications.

After running a simulation, SAM displays the performance metrics on the [Results](#) page:

- [Metrics table](#)
- [Tables](#), under **Metrics** (with additional variables under **Single Value**)
- [Graphs](#), with the **Single Value** option for **X Value**, or with [parametric](#) or other [analysis options](#) that involve input variables with multiple values.



**Note.** SAM may use slightly different names for the metrics, depending on the model options and where it displays the metric. For example, "net annual energy" may also appear as "annual energy."

SAM displays different metrics depending on the performance model that you specify on the [Technology and Market window](#).

The [annual energy](#) value appears for all of the performance models.

## Performance Metrics: Solar Technologies

The solar performance model abbreviations used in the following table are:

- PVW: [PVWatts](#)
- DPV: [Detailed photovoltaic](#)
- HCPV: [High concentration photovoltaic \(HCPV\)](#)
- TRP: [Parabolic Trough - Physical](#)
- TRE: [Parabolic Trough - Empirical](#)
- PTMS: [Power Tower - Molten Salt](#)
- LF: [Linear Fresnel](#)
- GSS: [Generic Solar System](#)
- SWH: [Solar Water Heating](#)

**Table 10. Performance model metrics for solar technologies.**

Metric	PVW	DPV	HCPV	TRP	TRE	PTMS	LF	GSS	SWH
<a href="#">Capacity Factor</a>	•	•	•	•	•	•	•	•	•
<a href="#">Energy Yield</a>	•	•							•
<a href="#">System Performance Factor</a>		•							
<a href="#">Gross to Net Conv Factor</a>				•	•	•	•	•	
<a href="#">Annual Water Usage</a>				•		•	•		
<a href="#">Aux With Solar (kWh)</a>									•
<a href="#">Aux Without Solar (kWh)</a>									•
<a href="#">Solar Fraction</a>									•

## Performance Metrics: Non-solar Technologies

The non-solar performance model abbreviations used in the following table are:

- GS: [Generic System](#)
- WP: [Wind Power](#)
- GP: [Geothermal Power](#)
- BP: [Biomass Power](#)

**Table 11. Performance model metrics for non-solar technologies.**

Metric	GS	WP	GP	BP
<a href="#">Energy Yield</a>		•		
<a href="#">Capacity Factor</a>	•	•	•	•
<a href="#">1st Year Energy Production (kWh)</a>			•	
<a href="#">Plant Lifetime Output (kWh)</a>			•	
<a href="#">Average Annual Output (kWh)</a>			•	
<a href="#">Pump Power (MW)</a>			•	
<a href="#">Annual biomass usage (dry tons/yr)</a>				•
<a href="#">Gross Heat Rate (MMBtu/MWh)</a>				•
<a href="#">Net Heat Rate (MMBtu/MWh)</a>				•
<a href="#">Thermal Efficiency, HHV (%)</a>				•
<a href="#">Thermal Efficiency, LLV (%)</a>				•

### 33.1 Annual Biomass Usage

For the biomass power model, Annual Biomass Usage is the annual biomass feedrate, equal to the total obtainable biomass resource from the [Feedstock](#) page.

SAM uses the value to calculate the system's [heat rate and thermal efficiency](#).

## 33.2 Annual Energy

SAM reports the total quantity of electricity generated by the system in Year one of the project [cash flow](#) and reports it in the Metrics table.

- For projects with one of the PPA financial models, SAM assumes that all of the electricity is sold to the grid at the [PPA price](#).
- For residential and commercial projects, some of the electricity generated by the system meets a building or facility load that you specify on the [Electric Load](#) page, and some is sold to the grid at the retail rates you specify on the [Electricity Rates](#) page.

### Annual Energy, kWh/year

All performance models except solar water heating systems.

$$\text{Annual Energy} = \text{Sum of Hourly Energy Delivered}$$

### Annual Energy Saved, kWh/year

For solar water heating systems, the annual energy saved is the electrical energy the project avoids purchasing due to the solar water heating system.

$$\text{Annual Energy Saved} = ( \text{Aux Without Solar} - \text{Aux With Solar} - \text{Pump Power} )$$

## 33.3 Annual Water Usage

For physical trough, power tower, and linear Fresnel systems, SAM reports the total annual water consumption in cubic meters for cooling and mirror washing.

### Annual Water Usage

$$\text{Annual Water Usage (m}^3\text{)} = \text{Cooling Water Usage (m}^3\text{)} + \text{Mirror Washing Water Usage (m}^3\text{)}$$

The mirror washing water usage is based on the mirror washing parameters you specify on the Solar Field or Heliostat Field page:

$$\text{Mirror Washing Usage} = \text{Water Usage per Wash (L/m}^2\text{, aperture)} \times \text{Total Aperture or Reflective Area (m}^2\text{)} \times \text{Washes per Year (1/year)}$$

SAM reports the annual mirror washing usage as a Single Values variable in [Tables](#) and [Graphs](#). It also reports the cooling water flow rate in Tables as an hourly variable ("water makeup flow rate" or "water consumption mass flow rate").

## 33.4 Aux with and without Solar (kWh)

The Solar Water Heating Model calculates the [annual energy savings](#) by a solar water heating system designed to meet the hourly hot water heating load defined by the hot water draw on the [SWH System](#) page. To do so, SAM calculates the following quantities, which you can see in the [Tables](#) on the Results page:

- Solar energy delivered to the water heater, *Q Collector to Tank*
- Electrical energy required to meet the remaining water heating load, *Auxiliary with SHW*
- Electrical energy required for a standard electric water heater with no solar system, *Auxiliary without SHW*
- Hourly electric pump power for the solar water heating system, *Pump Power*

### Aux With Solar

The energy supplied by the auxiliary electric water heating system to supplement energy from the solar collectors.

### Aux Without Solar

The energy that would be required from a standard electric hot water system if the solar system were not present.

## 33.5 Capacity Factor

The capacity factor is the ratio of the system's predicted electrical output in the first year of operation to the nameplate output, which is equivalent to the quantity of energy the system would generate if it operated at its nameplate capacity for every hour of the year. For PV systems, the capacity factor is an AC-to-DC value. For other systems, the capacity is an AC-to-AC value.

$$\text{Capacity Factor} = \text{Net Annual Energy (kWhac/yr)} / \text{System Capacity (kWdc or kWac)} / 8760 \text{ (h/yr)}$$

Where *Net Annual Energy* is the total annual electric generation in the first year of operation, and *System Capacity* is the system's nameplate capacity (see table below). For PV systems the capacity is in DC kW, for other system systems, the capacity is in AC kW.

The system nameplate capacity depends on technology being modeled. SAM converts the capacity value to the appropriate units (MW, kW, or W) before using it in calculations. For the photovoltaic models, the capacity is a DC power rating, and for the others it is an AC power rating. For the Solar Water Heating Model, the capacity is a thermal rating, while for the others it is an electric rating.

**Table 12. Nameplate system capacity values for each technology.**

Performance Model	System Capacity	Input Page
Detailed photovoltaic (DC)	Total Array Power (Wdc)	<a href="#">Array</a>
PVWatts (DC)	DC Rating (kWdc)	<a href="#">PVWatts Solar Array</a>
High concentration photovoltaic (DC)	System Nameplate Capacity	<a href="#">Array</a>
CSP Parabolic Trough - Physical (AC)	Estimated Net Output at Design (Nameplate) (MWe)	<a href="#">Power Cycle</a>
CSP Parabolic Trough - Empirical (AC)	Estimated Net Output at Design (MWe)	<a href="#">Power Block</a>
CSP Molten Salt Power Tower (AC)	Estimated Net Output at Design (Nameplate) (MWe)	<a href="#">Power Cycle</a>
CSP Generic Solar (AC)	Estimated Net Output at Design (Nameplate) (MWe)	<a href="#">Power Block</a>
CSP Linear Fresnel (AC)	Net nameplate capacity (MWe)	<a href="#">Power Cycle</a>
Generic System (AC)	Nameplate Capacity (kWe)	<a href="#">Power Plant</a>
Geothermal	Net Plant Output (MWe)	<a href="#">Plant and Equipment</a>
Water Heating Model (Thermal)	Nameplate Capacity (kWt)	<a href="#">SWH System</a>
Wind Power (AC)	System Nameplate Capacity (kWe)	<a href="#">Wind Farm</a>
Biopower (AC)	Nameplate Capacity, Gross (kWe)	<a href="#">Plant Specs</a>

## 33.6 Energy Yield

For PV systems, SAM reports the ratio of the system's annual AC electric output in Year one to its nameplate DC capacity:

$$\text{Energy Yield} = \text{Net Annual Energy} \div \text{Nameplate Capacity}$$

Where *Net Annual Energy* is the total annual electric generation in the first year of operation, and *Nameplate Capacity* is the system's DC nameplate capacity from the [System Design](#) page for the detailed photovoltaic model and the [System Design](#) page for the PVWatts model.

## 33.7 Gross to Net Conv Factor

For CSP systems, SAM displays the ratio of the system's annual AC electric output to the power block's gross electric output. The difference between the two is due to parasitic losses from electric loads in the solar field and power block for pumps, cooling equipment, etc.

$$\text{Gross to Net Conv Factor} = \text{Net Electric Output (kWh)} / \text{Gross Electric Output (kWh)}$$

Where *Net Electric Output* and *Gross Electric Output* are reported under Single Values in the [Tables](#).

## 33.8 Heat Rate and Thermal Efficiency

For biomass power systems, SAM reports the heat rate and thermal efficiency values from the system's net [annual energy](#) value calculated by the performance model, and the biomass feed rate and overall feedstock heating values from the [Feedstock](#) page.

### Gross Heat Rate, MMBtu/MWh

$$\text{Gross Heat Rate (MMBtu/MWh)} = \text{Dry Biomass Feed Rate (lb/year)} \times \text{Average Overall Feedstock HHV (MMBtu/lb)} \div \text{Net Annual Energy (MWh/year)}$$

### Net Heat Rate, MMBtu/MWh

$$\text{Net Heat Rate (MMBtu/MWh)} = \text{Dry Biomass Feed Rate (lb/year)} \times \text{Average Overall Feedstock LLV (MMBtu/lb)} \div \text{Net Annual Energy (MWh/year)}$$

The dry biomass feed rate is the annual feed rate from the [Feedstock](#) page (and also shown as Annual Biomass Usage in the Metrics table) converted from ton/year to lb/year (2000 lb = 1 ton), the average overall feedstock heating values are from the Feedstock page, converted from Btu/lb to MMBtu/lb (1,000,000 Btu = 1 MMBtu), Net Annual Energy is from the Metrics table.

### Thermal Efficiency HHV, %

$$\text{Thermal Efficiency HHV (\%)} = 341.23 \text{ (MMBtu/MWh)} \div \text{Gross Heat Rate (MMBtu/MWh)}$$

### Thermal Efficiency LHV, %

$$\text{Thermal Efficiency LHV (\%)} = 341.23 \text{ (MMBtu/MWh)} \div \text{Net Heat Rate (MMBtu/MWh)}$$

Where 341.23 MMBtu/MWh is the conversion factor between MMBtu and MWh units, and the heat rates are the values described above.

## 33.9 Pump Power

For geothermal power systems, SAM reports the pump power, which is equal to the pump work value on the [Plant and Equipment](#) page.

## 33.1 Solar Fraction

### 0

For [solar water heating](#) systems, the solar fraction is the ratio of solar energy to total energy delivered to the water storage tank. The solar fraction is based on the energy values for year one of the project cash flow.

#### Solar Fraction

$$\text{Solar Fraction} = \text{Total Solar Energy Delivered to Tank (kWh/year)} \div \text{Total Energy Delivered to Tank (kWh/year)}$$

Where

$$\text{Total Solar Energy Delivered to Tank (kWh)} = \text{Total Q Collector to Tank (kWh/year)} + \text{Aux With Solar (kWh/year)}$$

and *Total Q Collector to Tank* is the sum of the [hourly](#) Q Collector to Tank values.

## 33.1 Performance Ratio

### 1

The performance ratio is a measure of a photovoltaic system's annual electric generation output in AC kWh compared to its nameplate rated capacity in DC kW, taking into account the solar resource at the system's location, and shading and soiling of the array.

**Note.** SAM only calculates the system performance factor for the detailed photovoltaic model. It does not calculate the value for the PVWatts or high concentration photovoltaic (HCPV) models, or for the other technologies.

#### Performance ratio

$$\text{performance ratio} = \text{annual energy (kWh)} \div (\text{annual POA total radiation (nominal) (kWh)} \times \text{module efficiency (\%)})$$

Where *annual energy* is the system's total net AC output in Year One reported in the [Metrics](#) table, *annual POA total radiation (nominal)* is the total solar radiation incident on the array before shading and soiling losses are applied over the year, and *module efficiency* is the nominal efficiency of the modules in the array at standard test conditions STC.

To see the values used in this calculation, after running a simulation, on Results page, click [Data](#) and find the variables under **Single Values**. The module efficiency is from the [Module](#) page.

The method used to calculate the photovoltaic system performance factor is based on the method described in the SMA technical bulletin [Performance Ratio: Quality Factor for the PV Plant](#), *Perfratio-TI-en-1.1, Version 1.1*.

## 34 Cash Flow Details

SAM displays the cash flow variables in the [Cash Flow](#) table on the [Results page](#), and [Tables](#).

**Note.** If you are looking for the description of a specific variable in the cash flow table, click the link below for the financial model you are using, and then search the page for the variable name.

SAM displays a different set of cash flow variables depending on the financial model:

- [Residential and Commercial](#)
- [Single Owner](#)
- [All Equity Partnership Flip](#)
- [Leveraged Partnership Flip](#)
- [Sale Leaseback](#)

### 34.1 Residential and Commercial

This topic describes the [cash flow](#) table generated by the financial model for the residential and commercial financial models. See [Financial Models](#) for details.

SAM offers three options for exporting cash flow data:

- **Copy to clipboard** copies the table to your clipboard. You can paste the entire table into a word processing document, spreadsheet, presentation or other software.
- **Save as CSV** saves the table in a comma-delimited text file that you can open in a spreadsheet program or text editor.
- **Send to Excel** (Windows only) creates an Excel workbook that contains the data from the cash flow, but no formulas.
- **Send to Excel with Equations** (Windows only) exports the cash flow data to an existing Excel workbook that contains formulas to illustrate how SAM's internal cash flow calculations work. The workbooks are in the `runtime\spreadsheets` folder of your [SAM installation folder](#).

#### Notes.

SAM makes cash flow calculations internally during the simulation. It does not use Excel to make the calculations. The two **Send to Excel** options are to help you analyze the cash flow data and understand how SAM's internal calculations work.

You can also display cash flow data by building a [data](#) table.

#### Cash Flow Year

The cash flow year is displayed in the top row of the cash flow table. In the descriptions below, the letter *n*



indicates the cash flow year, where  $n = 0$  is Year Zero of the cash flow,  $n = 1$  is year one,  $n = 2$  is year two, etc.

## Energy (kWh)

### Energy Values for Financial Models Except Single Owner

#### Energy, kWh

For systems that generate electricity, the total amount of electricity generated by the system in AC kilowatt-hours for each year.

For solar water heating systems, the total amount of electricity saved by the solar water heating system in AC kilowatt-hours for each year.

### Energy Values for the Single Owner Financial Model

#### Energy to grid, kWh

Total AC electricity delivered to the grid by the power system in each year of the analysis period, including electricity from battery storage if applicable.

This value is the sum of the hourly or subhourly Electricity to grid values.

#### Energy from grid, kWh

Total grid AC electricity consumed by the power system in each year to meet loads for inverter night-time consumption, battery charging, and freeze protection and other parasitic loads for concentrating power systems.

This value is the sum of hourly or subhourly Electricity from grid values.

#### Net energy to grid, kWh

The total net AC electricity delivered to the grid by the power system in each year of the analysis period. For projects with a fixed power price, this is the value used to determine project revenue. For projects with time-of-delivery (TOD) power price multipliers, the revenue is calculated on a time-step basis.

## Energy and Degradation

For Year One of the project cash flow, the energy values are calculated the performance model

$$\text{Energy in Year One} = \text{Sum of Hourly or Sub-hourly Values}$$

Where Sum of Hourly or Sub-hourly Values is the system's total annual electrical output (or energy saved), equal to the sum of the values calculated by the performance model (8,760 values for hourly simulations).

For Years 2 and later:

$$\text{Energy in Year } n > 1 = \text{Energy in Year } n-1 \times (1 - \text{degradation rate})$$

Where Energy in Year  $n-1$  is the previous year's energy value and degradation rate is from the [Lifetime](#) page.

**Note.** If you specified **degradation rate** on the [Lifetime](#) page using the [annual schedule](#) option, SAM applies the value as follows:

$$\text{Energy in Year } n > 1 = \text{Energy in Year } 1 \times (1 - \text{degradation rate} \div 100\%)$$

## Value of electricity savings (\$)

The value of electricity that the project avoids purchasing because of the renewable energy system. The energy value in Year 1 is equal to the [Net savings with system](#) reported in the Metrics table.

The energy value in Years 2 and later is the Year 1 value adjusted by the inflation rate from the [Financial Parameters](#) page, and the electricity bill escalation rate from the [Electricity Rates](#) page.

## LCOE

The LCOE rows in the cash table show how SAM calculates the real and nominal [levelized cost of energy \(LCOE\)](#) values reported in the [Metrics table](#).

### NPV of After Tax Costflow - Nominal (\$)

The present worth of the after-tax cost flow, representing total cost of installing and operating the system over the project analysis period:

$$\begin{aligned}
 \text{NPV of After Tax Cost Flow Nominal} = & - [ \text{After Tax Cost in Year Zero} \\
 & + \text{After Tax Cost in Year 1} \div (1 + \text{Nominal Discount Rate } (\%)) \\
 & \div 100\% ]^{1} \\
 & + \text{After Tax Cost in Year 2} \div (1 + \text{Nominal Discount Rate } (\%)) \\
 & \div 100\% ]^{2} \\
 & + \text{After Tax Cost in Year 3} \div (1 + \text{Nominal Discount Rate } (\%)) \\
 & \div 100\% ]^{3} \\
 & + \dots \\
 & + \text{After Tax Cost in Year } N \div (1 + \text{Nominal Discount Rate} \\
 & (\%) \div 100\% ]^{N} ]
 \end{aligned}$$

Where the analysis period  $N$  and *Nominal Discount Rate* are both on the [Financial Parameters](#) page, and the [After Tax Cost](#) in Year  $n$  is at the bottom of the cash flow table.

### NPV of Energy - Nominal (kWh)

The present worth of the annual energy generated by the system, "discounted" at the nominal discount rate and representing the quantity in kWh of electricity generated by the system.

$$\begin{aligned}
 \text{NPV of Energy Nominal} = & \text{Energy in Year 1} \div (1 + \text{Nominal Discount Rate } (\%) \div 100\% ]^{1} \\
 & + \text{Energy in Year 2} \div (1 + \text{Nominal Discount Rate } (\%) \div 100\% ]^{2} \\
 & + \text{Energy in Year 3} \div (1 + \text{Nominal Discount Rate } (\%) \div 100\% ]^{3} \\
 & + \dots \\
 & + \text{Energy in Year } N \div (1 + \text{Nominal Discount Rate } (\%) \div 100\% ]^{N}
 \end{aligned}$$

Where the analysis period  $N$  and *Nominal Discount Rate* are both on the [Financial Parameters](#) page, and *Energy* is described above.

### LCOE - Nominal (cents/kWh)

The nominal levelized cost of energy:

$$\text{LCOE Nominal (cents/kWh)} = \text{NPV of After Tax Costflow Nominal } (\$) \div \text{NPV of Energy Nominal (kWh)} * 100 \text{ (cents/\$)}$$

### NPV of Energy - Nominal (kWh)

The present worth of the annual energy generated by the system, "discounted" at the real discount rate and representing the quantity in kWh of electricity generated by the system.

$$\begin{aligned}
 \text{NPV of Energy Real} = & \text{Energy in Year 1} \div (1 + \text{Real Discount Rate (\%)} \div 100\%)^1 \\
 & + \text{Energy in Year 2} \div (1 + \text{Real Discount Rate (\%)} \div 100\%)^2 \\
 & + \text{Energy in Year 3} \div (1 + \text{Real Discount Rate (\%)} \div 100\%)^3 \\
 & + \dots \\
 & + \text{Energy in Year N} \div (1 + \text{Real Discount Rate (\%)} \div 100\%)^N
 \end{aligned}$$

Where the analysis period  $N$  and *Real Discount Rate* are both on the Financial Parameters page.

### LCOE - Real (cents/kWh)

The real leveled cost of energy:

$$\text{LCOE Real (cents/kWh)} = \frac{\text{NPV of After Tax Cashflow Nominal (\$)}}{100 \text{ (cents/\$)}} \div \text{NPV of Energy Real (kWh)} *$$

## Operating Expenses

Operating expenses include O&M, insurance, and property tax payments. SAM also accounts for salvage value at the end of the analysis period as a negative operating expense.

### O&M (Operation and Maintenance)

The annual operation and maintenance (O&M) costs are defined on the [System Costs](#) page and may be calculated as a fixed amount, a cost per system rated capacity, a cost per unit of energy output, or any combination of the three:

$$\text{Fixed O\&M Annual in Year } n = \text{Fixed Annual Cost (\$/yr)} \times (1 + \text{Inflation Rate} + \text{Escalation Rate})^{n-1}$$

$$\text{Fixed O\&M in Year } n = \text{Fixed Cost by Capacity (\$/kW-yr)} \times \text{System Capacity} * (1 + \text{Inflation Rate} + \text{Escalation Rate})^{n-1}$$

$$\text{Variable O\&M in Year } n = \text{Variable Cost by Generation (\$/MWh)} / 1000 \text{ (kWh/MWh)} \times \text{Energy in Year } n \text{ (kWh)} \times (1 + \text{Inflation Rate} + \text{Escalation Rate})^{n-1}$$

Where Fixed Annual Cost, Fixed Cost by Capacity, Variable Cost by Generation, and Escalation Rate are from the [System Costs](#) page, and Inflation Rate is from the [Financial Parameters](#) page.

**Note.** When you specify O&M costs using an annual schedule instead of a single value, SAM does not apply the inflation rate or escalation rate to the values you specify for each year.

The system nameplate capacity depends on technology being modeled. SAM converts the capacity value to the appropriate units (MW, kW, or W) before using it in calculations. For the photovoltaic models, the capacity is a DC power rating, and for the others it is an AC power rating. For the Solar Water Heating Model, the capacity is a thermal rating, while for the others it is an electric rating.

**Table 13. Nameplate system capacity values for each technology.**

Performance Model	System Capacity	Input Page
Detailed photovoltaic (DC)	Total Array Power (Wdc)	<a href="#">Array</a>
PVWatts (DC)	DC Rating (kWdc)	<a href="#">PVWatts Solar Array</a>
High concentration photovoltaic (DC)	System Nameplate Capacity	<a href="#">Array</a>
CSP Parabolic Trough - Physical (AC)	Estimated Net Output at Design (Nameplate) (MWe)	<a href="#">Power Cycle</a>
CSP Parabolic Trough - Empirical (AC)	Estimated Net Output at Design (MWe)	<a href="#">Power Block</a>
CSP Molten Salt Power Tower (AC)	Estimated Net Output at Design (Nameplate) (MWe)	<a href="#">Power Cycle</a>
CSP Generic Solar (AC)	Estimated Net Output at Design (Nameplate) (MWe)	<a href="#">Power Block</a>
CSP Linear Fresnel (AC)	Net nameplate capacity (MWe)	<a href="#">Power Cycle</a>
Generic System (AC)	Nameplate Capacity (kWe)	<a href="#">Power Plant</a>
Geothermal	Net Plant Output (MWe)	<a href="#">Plant and Equipment</a>
Water Heating Model (Thermal)	Nameplate Capacity (kWt)	<a href="#">SWH System</a>
Wind Power (AC)	System Nameplate Capacity (kWe)	<a href="#">Wind Farm</a>
Biopower (AC)	Nameplate Capacity, Gross (kWe)	<a href="#">Plant Specs</a>

**Fuel**

The following performance models include a fuel cost calculation:

- Parabolic trough ([physical](#) or [empirical](#)) with fossil backup
- [Power tower](#) with fossil backup
- [Generic solar](#) system with fossil backup
- [Generic system](#) for the primary fuel cost
- [Biomass Power](#) for biomass and supplementary coal feedstock costs

**Note.** For the CSP systems listed above, SAM only considers the system to have a fossil-fired backup boiler when the fossil fill fraction variable on the Thermal Storage page is greater than zero.

For solar and generic systems listed above that consume a fuel, Fuel O&M is the annual fuel cost:

$$\text{Fuel O\&M in Year } n = \text{Annual Fuel Usage in Year One (kWh)} \times 0.003413 \text{ MMBtu per kWh} \times \text{Fossil Fuel Cost (\$/MMBtu)} \times (1 + \text{Inflation Rate} + \text{Escalation Rate})^{(n-1)}$$

Where *Annual Fuel Usage in Year One* is the quantity of fuel consumed in Year One calculated by the performance model. *Fossil Fuel Cost* and *Escalation Rate* are from the [System Costs](#) page, and

Inflation Rate is from the [Financial Parameters](#) page.

**Note.** When you specify fuel costs using an annual schedule instead of a single value, SAM does not apply the inflation rate or escalation rate to the values you specify for each year.

For the [biomass power](#) model, SAM calculates feedstock and coal costs using feedstock usage and price values from the [Feedstock Costs](#) page:

$$\text{Biomass Feedstock Costs in Year } n = \text{Total Biomass Fuel Usage in Year One (dry tons/year)} \times \text{Biomass Fuel Cost (\$/dry ton)} \times (1 + \text{Inflation Rate} + \text{Escalation Rate})^{(n-1)}$$

$$\text{Coal Feedstock Costs in Year } n = \text{Total Coal Fuel Usage in Year One (dry tons/year)} \times \text{Coal Fuel Cost (\$/dry ton)} \times (1 + \text{Inflation Rate} + \text{Escalation Rate})^{(n-1)}$$

Where the fuel usage and fuel costs are from the [Feedstock Costs](#) page, and *Inflation Rate* and *Escalation Rate* are from the [Financial Parameters](#) page.

### Insurance

The insurance cost applies in Year One and later of the cash flow:

$$\text{Insurance in Year } n = \text{Total Installed Costs (\$)} \times \text{Insurance (\%)} \times (1 + \text{Inflation Rate})^{(n-1)}$$

Where *Total Installed Costs* is the value from the [System Costs](#) page, and *Insurance* and *Inflation Rate* are specified on the [Financial Parameters](#) page.

### Property Assessed Value

The property assessed value is the value SAM uses as a basis to calculate the annual property tax payment:

$$\text{Property Assessed Value in Year One} = \text{Assessed Value}$$

Where *Assessed Value* is from the [Financial Parameters](#) page.

In Years 2 and later, the property assessed value is the Year One value adjusted by the assessed value decline value from the [Financial Parameters](#) page:

$$\text{Property Assessed Value in Year } n > 1 = \text{Assessed Value in Year One} \times [1 - \text{Assessed Value Decline} \times (n-1)]$$

Where *Assessed Value Decline* is from the [Financial Parameters](#) page, expressed as a fraction instead of a percentage.

If the value of  $1 - \text{Assessed Value Decline} \times (n-1)$  for a given year is equal to zero or less, then the *Property Assessed Value* in that year is zero.

### Property Taxes

Property taxes apply in Year One and later of the cash flow:

$$\text{Property Taxes in Year } n = \text{Property Assessed Value in Year } n (\$) \times \text{Property Tax (\%)}$$

Where *Property Assessed Value* is described above, and *Property Tax* is from the [Financial Parameters](#) page.

### Net Salvage Value

SAM calculates the net salvage value using the percentage you specify on the [Financial Parameters](#) page and the total installed cost from the [System Costs](#) page. The salvage value applies in the final year of the project cash flow.

For example, if you specify a 10% salvage value for a project with a 30-year analysis period, and total installed cost of \$1 million, SAM includes income in Year 30 of  $\$100,000 = \$1,000,000 \times 0.10$ .

SAM adds the salvage value as income (a negative value) to the operating expenses in the cash flow in the final year of the analysis period. The salvage value therefore reduces the operating expenses in the final year of the analysis period.

For residential projects, the salvage value has no effect on federal and state income tax because operating expenses are not taxable.

For commercial projects, because the salvage value reduces the operating expenses in the final year of the analysis period, it increases the federal and state income tax payment because operating expenses are deductible from federal and state income tax.

### Operating Costs

The total operating costs include operation and maintenance costs, and insurance and property tax payments:

$$\text{Operating Costs} = \text{Fixed O\&M Annual} + \text{Fixed O\&M} + \text{Variable O\&M} + \text{Fuel} + \text{Insurance} + \text{Property Taxes} - \text{Salvage Value}$$

### Deductible Expenses

The deductible expenses are project costs that can be deducted from federal and state income taxes.

For residential projects, the deductible expense amount equals the property tax amount:

$$\text{Deductible Expenses} = - \text{Property Taxes}$$

For commercial projects, all operating costs are deductible:

$$\text{Deductible Expenses} = - \text{Operating Costs}$$

### Financing

#### Debt Balance

The debt balance in Year One represents the debt portion of the investment costs, less incentives.

For residential and commercial:

$$\text{Debt Balance in Year One} = - (\text{Total Installed Costs} - \text{Total IBI} - \text{Total CBI}) \times \text{Debt Percent}$$

Where *Total Installed Costs* is from the [System Costs](#) page, *Total IBI* and *Total CBI* are the sums of all investment-based and capacity-based incentives specified on the [Incentives](#) page, and *Debt Percent* is the value specified on the [Financial Parameters](#) page. *Construction Financing Costs* is from the Financial Parameters page.

In Years Two and later, the debt balance is calculated from the previous year's debt balance and debt repayment amounts:

$$\text{Debt Balance in Year } n > 1 = \text{Debt Balance in Year } n-1 + \text{Debt Repayment in Year } n-1$$

#### Notes.

SAM shows the debt balance as a negative value to indicate net annual outflow. A value of zero indicates all debt is paid off.

The debt balance in Year One is different from the Principal Amount on the Financial Parameters page when your analysis includes either capacity-based or investment-based incentives.

### Debt Interest Payment

The debt interest payment is the annual interest paid on debt:

$$\text{Debt Interest Payment in Year } n = - \text{Debt Balance in Year } n \times \text{Loan Rate}$$

Where *Debt Balance* is described above, and *Loan Rate* is from the Financial Parameters page.

### Debt Repayment

The debt repayment amount is the annual payment on principal amount assuming constant payments over the loan term. SAM calculates the amount using the levelized mortgage payment methodology equivalent to Excel's PPMT function:

$$\text{Debt Repayment in Year } n = -\text{PPMT}(\text{Loan Rate}, n, \text{Loan Term}, \text{Principal Amount}, 0, 0)$$

Where *Loan Rate*, *Loan Term*, and *Principal Amount* are from the Financial Parameters page.

### Debt Total Payment

The total debt payment is the sum of interest and principal payments:

$$\text{Debt Total Payment} = \text{Debt Interest Payment} + \text{Debt Repayment}$$

## Incentives

The incentive cash flow rows show the value of cash incentives and tax credits, which are used to calculate cash flows described above.

### IBI (Investment Based Incentives)

Each IBI (federal, state, utility, other) applies in Year Zero of the project cash flow.

Because you can specify each IBI on the [Incentives](#) page as either an amount or a percentage, SAM calculates the value of each IBI as the sum of two values:

$$\text{IBI as Amount} = \text{Amount}$$

$$\text{IBI as Percentage} = \text{Total Installed Cost (\$)} \times \text{Percentage (\%)}, \text{ up to Maximum}$$

$$\text{IBI in Year } 0 = \text{IBI as Amount} + \text{IBI as Percentage}$$

Where *Amount*, *Percentage* and *Maximum* are the values that you specify on the [Incentives](#) page, and *Total Installed Cost* is from the [System Costs](#) page.

*Total IBI* is the sum of the four IBI values (federal, state, utility, other).

**Note.** The IBI amount reduces the after tax cost flow in Year Zero, and the debt balance in Year One. This is because SAM assumes that debt payments begin in Year One, when the project is generating or saving electricity.

### CBI (Capacity Based Incentives)

Each CBI (federal, state, utility, other) applies in Year Zero of the project cash flow:

$$\text{CBI in Year } 0 = \text{System Capacity (W)} \times \text{Amount (\$/W)}, \text{ up to Maximum}$$

Where *System Capacity* is the rated capacity of the system, and *Amount* and *Maximum* are the values you specify on the [Incentives](#) page.

*Total CBI* is the sum of the four CBI values (federal, state, utility, other).

The system nameplate capacity depends on technology being modeled. SAM converts the capacity value to the appropriate units (MW, kW, or W) before using it in calculations. For the photovoltaic models, the capacity is a DC power rating, and for the others it is an AC power rating. For the Solar Water Heating

Model, the capacity is a thermal rating, while for the others it is an electric rating.

**Table 14. Nameplate system capacity values for each technology.**

Performance Model	System Capacity	Input Page
Detailed photovoltaic (DC)	Total Array Power (Wdc)	<a href="#">Array</a>
PVWatts (DC)	DC Rating (kWdc)	<a href="#">PVWatts Solar Array</a>
High concentration photovoltaic (DC)	System Nameplate Capacity	<a href="#">Array</a>
CSP Parabolic Trough - Physical (AC)	Estimated Net Output at Design (Nameplate) (MWe)	<a href="#">Power Cycle</a>
CSP Parabolic Trough - Empirical (AC)	Estimated Net Output at Design (MWe)	<a href="#">Power Block</a>
CSP Molten Salt Power Tower (AC)	Estimated Net Output at Design (Nameplate) (MWe)	<a href="#">Power Cycle</a>
CSP Generic Solar (AC)	Estimated Net Output at Design (Nameplate) (MWe)	<a href="#">Power Block</a>
CSP Linear Fresnel (AC)	Net nameplate capacity (MWe)	<a href="#">Power Cycle</a>
Generic System (AC)	Nameplate Capacity (kWe)	<a href="#">Power Plant</a>
Geothermal	Net Plant Output (MWe)	<a href="#">Plant and Equipment</a>
Water Heating Model (Thermal)	Nameplate Capacity (kWt)	<a href="#">SWH System</a>
Wind Power (AC)	System Nameplate Capacity (kWe)	<a href="#">Wind Farm</a>
Biopower (AC)	Nameplate Capacity, Gross (kWe)	<a href="#">Plant Specs</a>

### PBI (Performance Based Incentive)

Each PBI (federal, state, utility, other) applies in Years One and later of the project cash flow, up to the number of years you specify:

$$PBI \text{ in Year } n = \text{Amount } (\$/kWh) \times \text{Energy in Year } n \text{ (kWh)} \times (1 + \text{Escalation})^{(n-1)}, \text{ up to Term}$$

Where *Amount*, *Term*, and *Escalation* are the values you specify on the [Incentives](#) page, and *Energy* is the value displayed in Energy row of the cash flow table (described above).

**Note.** If you use an annual schedule to specify year-by-year PBI amounts, SAM ignores the escalation rate.

*Total PBI* is the sum of the four PBI amounts (federal, state, utility, other).

**Important Note!** If you specify a PBI amount on the Cash Incentives page, be sure to also specify the incentive term. If you specify a term of zero, the incentive will not appear in the cash flow table.

### PTC (Production Tax Credit)

The state and federal PTC each apply in Year One and later of the project cash flow, up to the number



of years you specify:

$$PTC \text{ in Year } n = \text{Amount } (\$/kWh) \times (1 + \text{Escalation})^{(n-1)} \times \text{Energy in Year } n \text{ (kWh)}$$

Where *Amount*, *Term*, and *Escalation* are the values you specify on the [Incentives](#) page, and *Energy* is the value displayed in the Energy row of the cash flow table (described above).

SAM rounds the product  $\text{Amount } (\$/kWh) \times (1 + \text{Escalation})^{(n-1)}$  to the nearest multiple of 0.1 cent as described in Notice 2010-37 of [IRS Bulletin 2010-18](#).

**Note.** If you specify year-by-year PTC rates on the Incentives page using an Annual Schedule instead of a single value, SAM ignores the PTC escalation rate.

### ITC (Investment Tax Credit)

The state and federal ITC each apply only in Year One of the project cash flow. For ITCs that you specify as a fixed amount:

$$ITC \text{ in Year One} = \text{Amount}$$

Where *Amount* is the value you specify in the [Incentives](#) page.

For ITCs that you specify as a percentage of total installed costs:

$$ITC \text{ in Year One} = ( \text{Total Installed Cost } (\$) - \text{ITC Basis Reduction } (\$) ) \times \text{Percentage } (\%), \text{ up to Maximum}$$

Where *Total Installed Cost* is from the [System Costs](#) page, and *Percentage* and *Maximum* are the values you specify on the [Incentives](#) page.

*ITC Basis Reduction* applies only to the Commercial and PPA financial models, and depends on whether the project includes any investment-based incentives (IBI) or capacity-based incentives (CBI) specified on the [Incentives](#) page with checked boxes under **Reduces Depreciation and ITC Bases**. For each IBI or CBI with a check mark, SAM subtracts the incentive amount from the total installed cost to calculate the ITC.

$$ITC \text{ Basis Reduction} = IBI + CBI$$

Where *IBI* and *CBI* are the incentives that you have specified reduce the ITC basis on the [Incentives](#) page.

### Tax Effect on Equity -- State

The tax effect on equity cash flows are the tax calculations for state income taxes. SAM makes the following state income tax assumptions:

- For the Residential and Commercial financial models, state taxable income is the sum of all incentive payments in a given year that you specify as State taxable on the [Incentives](#) page.
- For the Commercial financial model, income tax paid on the value of energy is accounted for in the after-tax cash flow described below. For the Residential option, income tax is not paid on the value of energy.
- The state tax rate is the value you specify on the [Financial Parameters](#) page.
- Investment-based incentives that appear in Year Zero of the cash flow are taxable in Year One.
- Project operating costs are tax deductible for both the Residential and Commercial financial models.

- Debt interest payments are deductible for the Residential option with a Mortgage type loan and for the Commercial option. Debt interest payments are not tax deductible for the Residential option with the Standard Loan type loan. You specify the residential loan type on the [Financial Parameters](#) page.

## Depreciation (Commercial Only)

Depreciation applies only to the Commercial financial model, and depends on the depreciation schedule from the [Depreciation](#) page.

### State Depreciation Schedule

For the Commercial financial model with a depreciation option defined on the [Depreciation](#) page, SAM displays the state depreciation percentage in the State Depreciation Schedule row of the cash flow table. SAM determines the depreciation schedule (percentage and applicable years) based on the options you specify for state depreciation on the Depreciation page.

For the Residential financial model, depreciation does not apply, and SAM displays zeros in the cash flow.

### State Depreciation

The depreciation amount is the product of the depreciation percentage determined by the depreciation schedule described above, and the depreciable base:

$$\text{Depreciation in Year } n = \text{Depreciation Schedule (\% in Year } n \times (\text{Net Capital Cost} - \text{Depreciation Basis Reduction})$$

Where *Depreciation Schedule* is described above, and the *Net Capital Cost* is the total installed cost from the [System Costs](#) page less any incentives from the Incentives page that reduce the depreciation basis.

*Basis Reduction* depends on whether the project includes any investment-based incentives (IBI) or capacity-based incentives (CBI) specified on the [Incentives](#) page with checked **State** boxes in the **Reduces Depreciation and ITC Bases** column, or an investment tax credit (ITC) with checked **State** boxes in the **Reduces Depreciation Basis** column. For each IBI, CBI, or ITC with a check mark, SAM subtracts the total incentive amount and fifty percent of the tax credit amount from the total installed cost to calculate the depreciable base:

$$\text{Depreciation Basis Reduction Year } n = \text{ITC} \times 0.5 + \text{IBI} + \text{CBI} + \text{PBI}$$

Where *ITC* includes all tax credits that you specified on the [Incentives](#) page to reduce the depreciation basis, and *IBI*, *CBI*, and *PBI* include all incentives you specified to reduce the depreciation basis.

For the Residential financial model, depreciation does not apply, and SAM displays zeros in the cash flow.

## State Income Taxes

The state income tax is the annual income tax owed before accounting for tax credits. A negative value indicates a net tax liability (tax owed), and a positive value indicates a net tax benefit (tax refund).

### State Income Taxes: Residential with Standard Loan

For the Residential financial model with the Standard Loan loan type on the [Financial Parameters](#) page, debt interest payments are not tax-deductible:

$$\begin{aligned} \text{Income Taxes in Year One} &= \text{State Tax Rate} \\ &\times (\text{Total IBI in Year Zero} \\ &+ \text{Total CBI in Year Zero}) \end{aligned}$$

$$\begin{aligned}
 &+ \text{Total PBI in Year One} \\
 &+ \text{Deductible Expenses in Year One} )
 \end{aligned}$$

$$\begin{aligned}
 \text{Income Taxes in Year } n > 1 &= \text{State Tax Rate} \\
 &\times ( \text{Total PBI in Year } n \\
 &+ \text{Deductible Expenses in Year } n )
 \end{aligned}$$

### State Income Taxes: Residential with Mortgage Loan

For the Residential financial model with the Mortgage loan type on the [Financial Parameters](#) page, debt interest payments are deducted:

$$\begin{aligned}
 \text{Income Taxes in Year One} &= \text{State Tax Rate} \\
 &\times ( \text{Total IBI in Year Zero} \\
 &+ \text{Total CBI in Year Zero} \\
 &+ \text{Total PBI in Year One} \\
 &+ \text{Deductible Expenses in Year One} \\
 &- \text{Debt Interest Payment in Year One} )
 \end{aligned}$$

$$\begin{aligned}
 \text{Income Taxes in Year } n > 1 &= \text{State Tax Rate} \\
 &\times ( \text{Total PBI in Year } n \\
 &+ \text{Deductible Expenses in Year } n \\
 &- \text{Debt Interest Payment in Year } n )
 \end{aligned}$$

### State Income Taxes: Commercial

For the Commercial financial model, SAM includes a depreciation deduction in the tax equation:

$$\begin{aligned}
 \text{Income Taxes in Year One} &= \text{State Tax Rate} \\
 &\times ( \text{Total IBI in Year Zero} \\
 &+ \text{Total CBI in Year Zero} \\
 &+ \text{Total PBI in Year One} \\
 &+ \text{Deductible Expenses in Year One} \\
 &- \text{Debt Interest Payment in Year One} \\
 &- \text{State Depreciation in Year One} )
 \end{aligned}$$

$$\begin{aligned}
 \text{Income Taxes in Year } n > 1 &= \text{State Tax Rate} \\
 &\times ( \text{Total PBI in Year } n \\
 &+ \text{Deductible Expenses in Year } n \\
 &- \text{Debt Interest Payment in Year } n \\
 &- \text{State Depreciation in Year } n )
 \end{aligned}$$

#### Notes.

Because of the way it is defined, *Deductible Expenses* is negative when it represents a reduction in taxes, and so is an addition in the taxable income equation rather than a subtraction.

For the Residential and Commercial financial models (except Commercial PPA), SAM assumes that electricity generated by the project displaces electricity that would have been purchased from the grid without the system. Therefore, SAM does not consider electricity sales for residential and commercial projects to be taxable income.

### State Tax Savings

The net tax savings, accounting for income taxes and tax credits:

$$\begin{aligned} \text{State Tax Savings in Year One} &= \text{State ITC in Year One} \\ &+ \text{State PTC in Year One} \\ &- \text{State Income Taxes in Year One} \end{aligned}$$

$$\text{State Tax Savings in Year } n > 1 = \text{State PTC in Year } n - \text{State Income Taxes in Year } n$$

## Tax Effect on Equity -- Federal

The tax effect on equity cash flows are the tax calculations for federal income taxes. SAM makes the following federal income tax assumptions:

- For the Residential and Commercial financial models, federal taxable income includes any incentive payments that you specify as Federally taxable on the [Incentives](#) page, and the value of State Tax Savings.
- For the Commercial financial model, income tax paid on the value of energy is accounted for in the after-tax cash flow described below. For the Residential option, income tax is not paid on the value of energy.
- The federal tax rate is the value you specify on the [Financial Parameters](#) page.
- Investment-based incentives that appear in Year Zero of the cash flow are taxable in Year One.
- Project operating costs are tax deductible for both the Residential and Commercial financial models.
- Debt interest payments are deductible for the Residential option with a Mortgage type loan and for the Commercial option. Debt interest payments are not tax deductible for the Residential option with the Standard Loan type loan. You specify the residential loan type on the [Financial Parameters](#) page.

## Depreciation (Commercial Only)

Depreciation applies only to the Commercial financial model, and depends on the depreciation schedule from the [Depreciation](#) page.

### Federal Depreciation Schedule

For the Commercial financial model with a depreciation option defined on the [Depreciation](#) page, SAM displays the federal depreciation percentage in the Federal Depreciation Schedule row of the cash flow table. SAM determines the depreciation schedule (percentage and applicable years) based on the options you specify for state depreciation on the [Depreciation](#) page.

For the Residential financial model, depreciation does not apply, and SAM displays zeros in the cash flow.

### Federal Depreciation

The depreciation amount is the product of the depreciation percentage determined by the depreciation schedule described above, and the total installed costs:

$$\text{Depreciation in Year } n = \text{Depreciation Schedule (\% in Year } n \times (\text{Total Installed Costs} - \text{Depreciation Basis Reduction}))$$

Where *Depreciation Schedule* is described above, and the *Total Installed Costs* is from the [System Costs](#) page.

*Basis Reduction* depends on whether the project includes any investment-based incentives (IBI) or capacity-based incentives (CBI) specified on the [Incentives](#) page with checked **Federal** boxes in the **Reduces Depreciation and ITC Bases** column, or an investment tax credit (ITC) on the [Incentives](#) page with checked **Federal** boxes in the **Reduces Depreciation Basis** column. For each IBI, CBI, or

ITC with a check mark, SAM subtracts the total incentive amount and fifty percent of the tax credit amount from the total installed cost to calculate the depreciable base:

$$\text{Depreciation Basis Reduction Year } n = \text{Total ITC} \times 0.5 + \text{Total IBI} + \text{Total CBI} + \text{Total PBI}$$

Where *ITC* includes all tax credits that you specified on the [Incentives](#) page to reduce the depreciation basis, and *IBI*, *CBI*, and *PBI* include all incentives you specified to reduce the depreciation basis.

For the Residential financial model, depreciation does not apply, and SAM displays zeros in the cash flow.

## Federal Income Taxes

The federal income tax is the annual income tax owed before accounting for tax credits. A negative value indicates a net tax liability (tax owed), and a positive value indicates a net tax benefit (tax refund).

### Federal Income Taxes: Residential with Standard Loan

For the Residential financial model with the Standard Loan loan type on the [Financial Parameters](#) page, debt interest payments are not tax-deductible:

$$\begin{aligned} \text{Income Taxes in Year One} &= \text{Federal Tax Rate} \\ &\times ( \text{Total IBI in Year Zero} \\ &\quad + \text{Total CBI in Year Zero} \\ &\quad + \text{Total PBI in Year One} \\ &\quad + \text{State Tax Savings in Year One} \\ &\quad - \text{Property Taxes in Year One} ) \end{aligned}$$

$$\begin{aligned} \text{Income Taxes in Year } n > 1 &= \text{Federal Tax Rate} \\ &\times ( \text{Total PBI in Year } n \\ &\quad + \text{State Tax Savings in Year } n \\ &\quad - \text{Property Tax in Year } n ) \end{aligned}$$

### Federal Income Taxes: Residential with Mortgage Loan

For the Residential financial model with the Mortgage loan type on the [Financial Parameters](#) page, debt interest payments are deducted:

$$\begin{aligned} \text{Income Taxes in Year One} &= \text{Federal Tax Rate} \\ &\times ( \text{Total IBI in Year Zero} \\ &\quad + \text{Total CBI in Year Zero} \\ &\quad + \text{Total PBI in Year One} \\ &\quad + \text{State Tax Savings in Year One} \\ &\quad - \text{Property Tax in Year One} \\ &\quad - \text{Debt Interest Payment in Year One} ) \end{aligned}$$

$$\begin{aligned} \text{Income Taxes in Year } n > 1 &= \text{Federal Tax Rate} \\ &\times ( \text{Total PBI in Year } n \\ &\quad + \text{State Tax Savings in Year } n \\ &\quad - \text{Property Tax in Year } n \\ &\quad - \text{Debt Interest Payment in Year } n ) \end{aligned}$$

### Federal Income Taxes: Commercial

For the Commercial financial model, SAM includes a depreciation deduction in the tax equation:

$$\begin{aligned} \text{Income Taxes in Year One} &= \text{Federal Tax Rate} \\ &\times ( \text{Total IBI in Year Zero} \\ &\quad + \text{Total CBI in Year Zero} \end{aligned}$$

+ Total PBI in Year One  
 + State Tax Savings in Year One  
 - Operating Costs in Year One  
 - Debt Interest Payment in Year One  
 - Federal Depreciation in Year One )

Income Taxes in Year  $n > 1$  = Federal Tax Rate  
 × ( Total PBI in Year  $n$   
 + State Tax Savings in Year  $n$   
 - Operating Costs in Year  $n$   
 - Debt Interest Payment in Year  $n$   
 - Federal Depreciation in Year  $n$  )

**Notes.**

Because of the way it is defined, *Deductible Expenses* is negative when it represents a reduction in taxes, and so is added to the taxable income equation rather than subtracted.

For the Residential and Commercial financial models (except Commercial PPA), SAM assumes that electricity generated by the project displaces electricity that would have been purchased from the grid without the system. Therefore, SAM does not consider electricity sales for residential and commercial projects to be taxable income.

**Federal Tax Savings**

The federal tax savings is the net tax savings, accounting for income taxes and tax credits:

*Federal Tax Savings in Year One* = *Federal ITC in Year One*  
 + *Federal PTC in Year One*  
 - *Federal Income Taxes in Year One*

*Federal Tax Savings in Year  $n > 1$*  = *Federal PTC in Year  $n$*  - *Federal Income Taxes in Year  $n$*

**After Tax Cost and Cash Flow****After Tax Cost**

The after tax cost row represents the project's net annual costs for operating the system accounting for tax savings and incentive payments. It does not include the value of electricity generated by the system.

**Note.** SAM uses the present value of the after tax cost flow to calculate the [levelized cost of energy](#) for the residential and commercial financial models.

A positive after tax cost value represents a net inflow for the year, and a negative value represents a net outflow for the year.

Year Zero after tax cost are investment-related costs:

*After Tax Cost in Year Zero* = *Loan Principal Amount*  
 + *Total IBI in Year Zero*  
 + *Total CBI in Year Zero*  
 - *Total Installed Cost*

Where *Loan Principal Amount* is from the [Financial Parameters](#) page (equivalent to the Debt Balance in Year One of the cash flow), *Total IBI* and *Total CBI* are the values described above, and *Total Installed Cost* is from the [System Costs](#) page.

Year One is the first year that the project generates electricity. The after tax cost in Year One and subsequent years is:

$$\begin{aligned} \text{After Tax Cost in Year } n > 0 = & \text{State Tax Savings} \\ & + \text{Federal Tax Savings} \\ & + \text{Total PBI} \\ & - \text{Total Operating Expenses} \\ & - \text{Total Debt Payment} \end{aligned}$$

Where *State Tax Savings*, *Federal Tax Savings*, *Total PBI*, *Operating Costs*, *Total Operating Expenses*, and *Debt Total Payment* are values described above.

### After Tax Cash Flow

**Note.** The project after-tax [NPV](#) is the net present value of the after-tax cash flow.

The after tax cash flow represents the project's net cash flow including the value of energy generated by the system.

For the residential financial model, the value of energy is not taxable:

$$\text{After Tax Cash Flow in Year } n = \text{After Tax Cost in Year } n + \text{Energy Value in Year } n$$

For the commercial financial model, the after-tax cash flow is reduced by the state and federal income tax on the energy value. SAM assumes that without the renewable energy system, the commercial entity would have treated electricity purchases as a tax-deductible operating expense. With the system, the entity must pay tax on the portion of its income that it would have deducted:

$$\text{After Tax Cash Flow in Year } n = \text{After Tax Cost in Year } n + \text{Energy Value in Year } n \times (1 - \text{Effective Tax Rate})$$

Where *After Tax Cost* and *Energy Value* are described above.

The effective tax rate is a single number that includes both the federal income tax rate and state income tax rate:

$$\text{Effective Tax Rate} = \text{Federal Tax Rate} \times (1 - \text{State Tax Rate}) + \text{State Tax Rate}$$

The federal and state tax rates are input variables on the [Financial Parameters](#) page.

## 34.2 Single Owner

This topic describes the [cash flow](#) generated by the financial model for the Single Owner financial model. See [Financial Models](#) for details.

### Energy

#### Energy Values for Financial Models Except Single Owner

##### Energy, kWh

For systems that generate electricity, the total amount of electricity generated by the system in AC

kilowatt-hours for each year.

For solar water heating systems, the total amount of electricity saved by the solar water heating system in AC kilowatt-hours for each year.

## Energy Values for the Single Owner Financial Model

### Energy to grid, kWh

Total AC electricity delivered to the grid by the power system in each year of the analysis period, including electricity from battery storage if applicable.

This value is the sum of the hourly or subhourly Electricity to grid values.

### Energy from grid, kWh

Total grid AC electricity consumed by the power system in each year to meet loads for inverter night-time consumption, battery charging, and freeze protection and other parasitic loads for concentrating power systems.

This value is the sum of hourly or subhourly Electricity from grid values.

### Net energy to grid, kWh

The total net AC electricity delivered to the grid by the power system in each year of the analysis period. For projects with a fixed power price, this is the value used to determine project revenue. For projects with time-of-delivery (TOD) power price multipliers, the revenue is calculated on a time-step basis.

## Energy and Degradation

For Year One of the project cash flow, the energy values are calculated the performance model

$$\text{Energy in Year One} = \text{Sum of Hourly or Sub-hourly Values}$$

Where Sum of Hourly or Sub-hourly Values is the system's total annual electrical output (or energy saved), equal to the sum of the values calculated by the performance model (8,760 values for hourly simulations).

For Years 2 and later:

$$\text{Energy in Year } n > 1 = \text{Energy in Year } n-1 \times (1 - \text{degradation rate})$$

Where Energy in Year n-1 is the previous year's energy value and degradation rate is from the [Lifetime](#) page.

**Note.** If you specified **degradation rate** on the [Lifetime](#) page using the [annual schedule](#) option, SAM applies the value as follows:

$$\text{Energy in Year } n > 1 = \text{Energy in Year } 1 \times (1 - \text{degradation rate} \div 100\%)$$

## Revenues

### PPA price (cents/kWh)

The PPA price in Year One is either the value you specify on the [Financial Parameters](#) page, or the value calculated by SAM to meet the IRR target you specify on the Financial Parameters page. The PPA price in Year One is the PPA price:

$$\text{PPA Price in Year One} = \text{Adjusted PPA Price}$$

For analyses that do not involve time-dependent pricing, *Adjusted PPA Price* is equal to the [PPA Price](#) reported on the [Metrics table](#).

For analyses that do involve time-dependent pricing, for each hour of the year, SAM multiplies the [PPA](#)



[price](#) shown in the [Metrics table](#) (equivalent to the bid price) by the TOD factor for that hour to calculate a set of hourly energy prices for Year one. The *Adjusted PPA Price* is the average of the 8,760 hourly values.

#### Notes.

When you choose **Specify PPA Price** for **Solution Mode** on the Financial Parameters page, the [PPA Price](#) in the [Metrics table](#) is equal to the price you specify. When you choose **Specify IRR Target**, SAM calculates the PPA price required to meet the IRR target that you specify.

The TOD factors are on the Thermal Energy Storage page for CSP systems (parabolic trough, power tower, linear Fresnel, generic solar system), and on the [Revenue](#) page for photovoltaic and other systems.

To remove time-dependent pricing from your analysis, set the TOD factor for each of the 9 periods to one. Where Adjusted [PPA Price](#) is either the value you specify on the Financial Parameters page, or a value calculated to cover project costs based on the target IRR you specify on the [Financial Parameters](#) page, adjusted by the time-of-delivery (TOD) factors.

In Years Two and later:

$$PPA \text{ Price in Year } n > 1 = PPA \text{ Price in Year } n-1 \times (1 + PPA \text{ Escalation Rate})^{(n-1)}$$

Where *PPA Escalation Rate* is from the [Financial Parameters](#) page.

**Note.** SAM uses the PPA Price to calculate the [levelized cost of energy](#).

## Revenue for PPA Single Owner Financial Model

The Single Owner financial model reports three revenue values in the project cash flow.

### PPA revenue gross

The gross project revenue earned from electricity sales. For a project with a PPA price that does not vary with time of delivery, this is the net annual energy to grid in kWh multiplied by the PPA price in \$/kWh.

### PPA revenue lost to self-consumption

Revenue lost to grid power purchases to meet power system self-consumption loads such as inverter nighttime power consumption for photovoltaic systems, and freeze protection power and other parasitic loads for concentrating power systems.

For systems for battery storage, when the option on the [Electricity Rates](#) page is **No Electricity Rate**, revenue lost to self-consumption also includes power for battery charging.

### PPA revenue net

The net revenue earned from electricity sales, accounting for revenue lost do self-consumption.

## Revenue for PPA Partnership and Sale Leaseback Models

### PPA revenue to project

The project's annual revenue from electricity sales, not accounting for salvage value:

$$Total \ PPA \ Revenue = Net \ Energy \ (kWh) \times PPA \ Price \ (cents/kWh) \times 0.01 \ (\$/cents)$$

### Salvage value

SAM calculates the net salvage value using the percentage you specify on the [Financial Parameters](#) page and the total installed cost from the System Costs page. The salvage value applies in the final year of the project cash flow.

For example, if you specify a 10% salvage value for a project with a 30-year analysis period, and total installed cost of \$1 million, SAM includes income in Year 30 of  $\$100,000 = \$1,000,000 \times 0.10$ .

SAM adds the salvage value as income (a negative value) to the operating expenses in the cash flow in the final year of the analysis period. The salvage value therefore reduces the operating expenses in the final year of the analysis period.

For residential projects, the salvage value has no effect on federal and state income tax because operating expenses are not taxable.

For commercial projects, because the salvage value reduces the operating expenses in the final year of the analysis period, it increases the federal and state income tax payment because operating expenses are deductible from federal and state income tax.

### Total revenue to project

The projects annual revenue, accounting for salvage value.

$$\text{Total Revenue} = \text{Total PPA Revenue} + \text{Salvage Value}$$

Because Salvage Value is zero for all years except the last year of the analysis period, the Total Revenue and Total PPA Revenue are the same for all years except for the last year.

For the Single Owner and Leveraged Partnership Flip financial models (both of which include debt), total revenue may also include production-based [incentive](#) (PBI) amounts. For each PBI amount that you check on the [Financial Parameters](#) page under **Debt Service, Production Based Incentives (PBI) Available for Debt Service**, SAM displays a row for the PBI above the Total Revenue row, and includes the amount in the Total Revenue amount:

$$\text{Total Revenue} = \text{Total PPA Revenue} + \text{Salvage Value} + \text{PBI}$$

### Operating Expenses

The eight expense rows are for annual project costs calculated from assumptions you specify on the [Financing](#) and [System Costs](#) pages.

The four O&M expenses are based on the first year or annual schedule costs you specify under Operation and Maintenance Costs on the [System Costs](#) page, and are adjusted by the inflation rate from the [Financial Parameters](#) page and optional escalation rate from the System Costs page.

#### O&M Fixed expense

$$\text{O\&M Fixed Expense in Year } n = \text{Fixed Annual Cost } (\$) \times (1 + \text{Inflation Rate} + \text{Escalation Rate})^{n-1}$$

Where *Fixed Annual Cost* is from the [System Costs](#) page, and *Inflation Rate* and *Escalation Rate* are from the [Financial Parameters](#) page.

#### O&M Capacity-based expense

$$\text{O\&M Capacity-based Expense in Year } n = \text{Fixed Cost by Capacity } (\$/kW\text{-yr}) \times \text{System Rated Capacity} \times (1 + \text{Inflation Rate} + \text{Escalation Rate})^{n-1}$$

Where *Fixed Cost by Capacity* is from the [System Costs](#) page, and *Inflation Rate* and *Escalation Rate* are from the [Financial Parameters](#) page.

The system nameplate capacity depends on technology being modeled. SAM converts the capacity value to the appropriate units (MW, kW, or W) before using it in calculations. For the photovoltaic models, the capacity is a DC power rating, and for the others it is an AC power rating. For the Solar Water Heating Model, the capacity is a thermal rating, while for the others it is an electric rating.

**Table 15. Nameplate system capacity values for each technology.**

Performance Model	System Capacity	Input Page
Detailed photovoltaic (DC)	Total Array Power (Wdc)	<a href="#">Array</a>
PVWatts (DC)	DC Rating (kWdc)	<a href="#">PVWatts Solar Array</a>
High concentration photovoltaic (DC)	System Nameplate Capacity	<a href="#">Array</a>
CSP Parabolic Trough - Physical (AC)	Estimated Net Output at Design (Nameplate) (MWe)	<a href="#">Power Cycle</a>
CSP Parabolic Trough - Empirical (AC)	Estimated Net Output at Design (MWe)	<a href="#">Power Block</a>
CSP Molten Salt Power Tower (AC)	Estimated Net Output at Design (Nameplate) (MWe)	<a href="#">Power Cycle</a>
CSP Generic Solar (AC)	Estimated Net Output at Design (Nameplate) (MWe)	<a href="#">Power Block</a>
CSP Linear Fresnel (AC)	Net nameplate capacity (MWe)	<a href="#">Power Cycle</a>
Generic System (AC)	Nameplate Capacity (kWe)	<a href="#">Power Plant</a>
Geothermal	Net Plant Output (MWe)	<a href="#">Plant and Equipment</a>
Water Heating Model (Thermal)	Nameplate Capacity (kWt)	<a href="#">SWH System</a>
Wind Power (AC)	System Nameplate Capacity (kWe)	<a href="#">Wind Farm</a>
Biopower (AC)	Nameplate Capacity, Gross (kWe)	<a href="#">Plant Specs</a>

#### O&M Production-based expense

$$O\&M\ Production\text{-}based\ Expense\ in\ Year\ n = Variable\ Cost\ by\ Generation\ (\$/MWh) \times Net\ Energy\ in\ Year\ n\ (MWh) * (1 + Inflation\ Rate + Escalation\ Rate)^{(n-1)}$$

Where *Variable Cost by Generation* is from the [System Costs](#) page, *Net Energy* is described above, and *Inflation Rate* and *Escalation Rate* are from the [Financial Parameters](#) page.

#### O&M Fuel expense

The following performance models include a fuel cost calculation:

- Parabolic trough ([physical](#) or [empirical](#)) with fossil backup
- [Power tower](#) with fossil backup
- [Generic solar](#) system with fossil backup
- [Generic system](#) for the primary fuel cost

- [Biomass Power](#) for biomass and supplementary coal feedstock costs

**Note.** For the CSP systems listed above, SAM only considers the system to have a fossil-fired backup boiler when the fossil fill fraction variable on the Thermal Storage page is greater than zero.

For solar and generic systems listed above that consume a fuel, Fuel O&M is the annual fuel cost:

$$\text{Fuel O\&M in Year } n = \text{Annual Fuel Usage in Year One (kWh)} \times 0.003413 \text{ MMBtu per kWh} \times \text{Fossil Fuel Cost (\$/MMBtu)} \times (1 + \text{Inflation Rate} + \text{Escalation Rate})^{(n-1)}$$

Where *Annual Fuel Usage in Year One* is the quantity of fuel consumed in Year One calculated by the performance model. *Fossil Fuel Cost* and *Escalation Rate* are from the [System Costs](#) page, and *Inflation Rate* is from the [Financial Parameters](#) page.

**Note.** When you specify fuel costs using an annual schedule instead of a single value, SAM does not apply the inflation rate or escalation rate to the values you specify for each year.

For the [biomass power](#) model, SAM calculates feedstock and coal costs using feedstock usage and price values from the [Feedstock Costs](#) page:

$$\text{Biomass Feedstock Costs in Year } n = \text{Total Biomass Fuel Usage in Year One (dry tons/year)} \times \text{Biomass Fuel Cost (\$/dry ton)} \times (1 + \text{Inflation Rate} + \text{Escalation Rate})^{(n-1)}$$

$$\text{Coal Feedstock Costs in Year } n = \text{Total Coal Fuel Usage in Year One (dry tons/year)} \times \text{Coal Fuel Cost (\$/dry ton)} \times (1 + \text{Inflation Rate} + \text{Escalation Rate})^{(n-1)}$$

Where the fuel usage and fuel costs are from the [Feedstock Costs](#) page, and *Inflation Rate* and *Escalation Rate* are from the [Financial Parameters](#) page.

### Insurance expense

The insurance cost applies in Year One and later of the cash flow:

$$\text{Insurance in Year } n = \text{Total Installed Costs (\$)} \times \text{Insurance (\%)} \times (1 + \text{Inflation Rate})^{(n-1)}$$

Where *Total Installed Costs* is the value from the [System Costs](#) page, and Insurance and Inflation Rate are specified on the [Financial Parameters](#) page.

### Property tax net assessed value

The property assessed value is the value SAM uses as a basis to calculate the annual property tax payment:

$$\text{Property Assessed Value in Year One} = \text{Assessed Value}$$

Where *Assessed Value* is from the [Financial Parameters](#) page.

In Years 2 and later, the property assessed value is the Year One value adjusted by the assessed value decline value from the Financial Parameters page:

$$\text{Property Assessed Value in Year } n > 1 = \text{Assessed Value in Year One} \times [1 - \text{Assessed Value Decline} \times (n-1)]$$

Where *Assessed Value Decline* is from the Financial Parameters page, expressed as a fraction instead of a percentage.

If the value of  $1 - \text{Assessed Value Decline} \times (n-1)$  for a given year is equal to zero or less, then the *Property Assessed Value* in that year is zero.

### Property tax expense

Property taxes apply in Year One and later of the cash flow:

$$\text{Property Taxes in Year } n = \text{Property Assessed Value in Year } n (\$) \times \text{Property Tax } (\%)$$

Where *Property Assessed Value* is described above, and *Property Tax* is from the [Financial Parameters](#) page.

### Annual Developer (Lessee LLC) Margin (Sale Leaseback only)

$$\text{Annual Developer Margin in Year } n = \text{Developer Operating Margin} \times (1 + \text{Developer Margin Escalation})^{(n-1)}$$

Where *Developer Operating Margin* and *Developer Margin Escalation* are from the [Financing](#) page.

### Total operating expense

The total operating expense is the sum of expenses:

$$\text{Total Operating Expense in Year } n = \text{O\&M Fixed Expense} + \text{O\&M Capacity-based Expense} + \text{O\&M Production-based Expense} + \text{O\&M Fuel Expense} + \text{Insurance Expense} + \text{Property Tax Expense}$$

## EBITDA (\$)

Earnings before interest, taxes, depreciation and amortization:

$$\text{EBITDA} = \text{Total Revenue} - \text{Total Operating Expense}$$

Where *Total Revenue* and *Total Operating Expense* are described above.

## Cash Flows: Project

The project cash flows include those from operating activities, investing activities, incentives, and issuance of equity. The pre-tax cash flow is the total project cash flow.

### Cash Flow from Operating Activities

The cash flow from operating activities are the project earnings including interest on reserves and production-based incentives payments less interest paid on debt.

#### EBITDA

The earnings before interest, taxes, depreciation and amortization described above.

#### Interest on reserves

$$\text{Interest on Reserves} = \text{Total Reserves } (\$) \times \text{Interest on Reserves } (\%)$$

Where *Total Reserves* is the sum of *Major Equipment Reserves*, *Working Capital Reserve*, and *Debt Service Reserves*, and *Interest on Reserves* is from the [Financial Parameters](#) page.

#### PBI (Federal, State, Utility, Other, Total)

These values represent income from production-based incentive payments, calculated as described below under Incentives.

#### Total project cash flow from operating activities

$$\text{Total} = \text{EBITDA} + \text{Interest on Reserves} + \text{Total PBI} - \text{Interest}$$

### Cash Flow from Investing Activities

#### Purchase of property cost

The purchase of property cost applies only in Year Zero of the cash flow. It is the sum of the total

installed cost from the System Costs page and debt-related and financing costs from the Financial Parameters page less any investment-based incentives defined on the Incentives page:

$$\begin{aligned}
 \text{Purchase of Property Cost} &= \text{Total Installed Cost} \\
 &+ \text{Debt Closing Costs} \\
 &+ \text{Debt Up-front Fee} \\
 &+ \text{Financing Cost} \\
 &+ \text{Construction Financing Cost} \\
 &- \text{Total IBI} \\
 &- \text{Total CBI}
 \end{aligned}$$

The debt up-front fee is the product of the percent of total debt from the Financial Parameters page and the size of debt.

#### **(Increase)/Decrease in working capital reserve account**

The working capital reserve amount in Year Zero depends on the Months of Operating Costs from the [Financial Parameters](#) page and the Year One total operating expense:

$$\text{Capital Reserve in Year Zero} = \text{Total Operating Expense in Year One (\$)} \times \text{Months of Operating Costs (months)} \div 12 \text{ (months)}$$

In Year One and later:

$$\text{Capital Reserve in Year } n > 0 = \text{Capital Reserve in Year } n-1 \text{ (\$)} - \text{Total Operating Expense in Year } n \text{ (\$)} \times \text{Months of Operating Costs (months)} \div 12 \text{ (months)}$$

Where *Months of Operating Costs* is from the [Financial Parameters](#) page.

#### **(Increase)/Decrease in major equipment reserve accounts**

For each of the up to three major equipment reserve accounts that you specify on the [Financial Parameters](#) page, SAM calculates the annual amount required to ensure that sufficient funds are available in the replacement year to cover the replacement cost:

For example, in the example described below under Major Equipment Capital Spending, the annual increase in reserves is \$530,682/year = \$2,653,400 ÷ 5 years.

$$\text{Increase in Major Equipment Reserve} = \text{Inflation Adjusted Replacement Cost in Replacement Year (\$)} \div \text{Replacement Year (year)}$$

The increase is shown in the cash flow as a negative value.

In the year that the replacement occurs (in this example, Year 5), the decrease in major equipment reserve account is \$2,122,727 = \$2,653,400 - \$430,682.

$$\text{Decrease in Major Equipment Reserve in Replacement Year} = \text{Inflation Adjusted Replacement Cost in Replacement Year} - \text{Increase in Major Equipment Reserve}$$

The decrease is shown in the cash flow as a positive value.

#### **Major equipment capital spending**

For each of the up to three major equipment reserve accounts that you specify on the [Financial Parameters](#) page, the inflation-adjusted amount is reported in the year that you specify.

For example, if you specify a \$2,500 (in Year One dollars) replacement cost with a 5 year replacement frequency, and an inflation rate of 1.5% on the Financial Parameters page, SAM reports a major equipment capital spending amounts in years 5, 10, 15 etc. For Year 5, the amount would be \$2,653,400 = \$2,500,000 × (1 + 0.015)<sup>4</sup>.

In each year that the replacement occurs:

$$\text{Capital Spending} = - \text{Replacement Cost (Year One \$)} \times (1 + \text{Inflation Rate})^{(\text{Replacement Year} - 1)}$$

The value is negative because it represents an expense or outflow.

### Total cash flow from investing activities

The total cash flow from investing activities is the sum of purchase property cost, reserve account deposits or withdrawals, and capital spending:

$$\text{Total in Year Zero} = \text{Purchase of Property Cost} + \text{Debt Service (increase)/decrease} + \text{Working Capital (increase)/decrease}$$

$$\text{Total in Year } n > 0 = \text{Working Capital (increase)/decrease} + \text{Major Equipment (increase)/decrease} + \text{Reserve Capital Spending}$$

## Cash Flow from Financing Activities

Cash flows from financing activities include income from incentive payments, equity capital, and, for Single Owner and Leveraged Partnership Flip, debt capital.

### Total IBI

The total investment-based incentive amount, described below.

### Total CBI

The total capital-based incentive amount, described below.

### Equity Capital

The equity capital invested in the project.

$$\text{Issuance of Equity in Year Zero} = \text{Total Installed Cost} + \text{Financing Cost} - (\text{Debt Funding} + \text{Total IBI} + \text{Total CBI})$$

Where *Total Installed Cost* is the project capital cost from the [System Costs](#) page, *Financing Cost* is the total debt costs and development fees, *Debt* (Single Owner and Leveraged Partnership Flip only) is the debt funding amount described below, and *Total IBI* and *Total CBI* are the investment-based incentive and capacity based incentive amounts described below.

### Total project cash flow from financing activities

The total cash flow from financing activities is the sum of equity capital, incentive payments, and debt capital.

$$\text{Total in Year Zero} = \text{Issuance of Equity} + \text{Total IBI} + \text{Total CBI} + \text{Debt Funding}$$

$$\text{Total in Year } n > 0 = \text{Debt Repayment}$$

### Project total pre-tax cash flow

The pre-tax cash flow is the cash flow and accounts for operating expenses, investment earnings, and incentive payments.

$$\text{Total Project Pre-tax Cash Flow in Year Zero} = \text{Issuance of Equity}$$

Where *Issuance of Equity* is the equity investment in the project described above.

$$\text{Total Project Pre-tax Cash Flow in Year } n > 0 = \text{Total Cash Flows from Operating Activities} + \text{Total Cash Flows from Investing Activities} + \text{Total Incentives}$$

## Total Project Returns

The total project returns rows of the cash flow table show pre- and after-tax cash flows and returns from the project perspective. Returns from each partner's perspective appear under the Partners Returns heading and

are described below.

## Project pre-tax returns

### Total project pre-tax returns

The total annual pre-tax cash flow is the cash flow and accounts for operating expenses, investment earnings, and incentive payments.

$$\text{Pre-tax Cash Flow in Year Zero} = \text{Issuance of Equity}$$

Where *Issuance of Equity* is the equity investment in the project described above.

$$\text{Pre-tax Cash Flow in Year } n > 0 = \text{Total Cash Flows from Operating Activities} + \text{Total Cash Flows from Investing Activities} + \text{Total Incentives}$$

### Project pre-tax cumulative IRR

SAM calculates the cumulative IRR for each year N of the cash flow. The cumulative IRR in a given Year N is the discount rate that results in a value of zero for the present value of the discounted pre-tax cash flows up to Year N:

$$NPV = \sum_{n=0}^N \frac{C_{PreTax,n}}{(1 + IRR)^n} = 0$$

Where  $C_{PreTax,n}$  is the pre-tax cash flow described above.

### Project pre-tax cumulative NPV

The cumulative net present value in a given Year N is the sum of the present values of the pre-tax cash flows up to Year N:

$$NPV = \sum_{n=0}^N \frac{C_{PreTax,n}}{(1 + d_{nominal})^n}$$

Where  $C_{PreTax,n}$  is the pre-tax cash flow described above,  $d_{nominal}$  is the nominal discount rate from the [Financial Parameters](#) page.

## Project after-tax returns

### Cash

The pre-tax cash flow, described above.

### Total project after-tax returns

The total annual after-tax cash flow is the sum of the pre-tax cash flow and tax credits less income tax payments:

$$\text{After-tax Cash Flow in Year Zero} = \text{Pre-tax Cash Flow in Year Zero}$$

$$\text{After-tax Cash Flow in Year One} = \text{Pre-tax Cash Flow in Year One} + \text{Total ITC} + \text{Total PTC} + \text{Project Tax Benefit}$$

$$\text{After-tax Cash Flow in Year } n > 1 = \text{Pre-tax Cash Flow in Year } n + \text{Total PTC} + \text{Project Tax Benefit}$$

### Project after-tax cumulative IRR

SAM calculates the cumulative IRR for each year N of the cash flow. The cumulative IRR in a given Year N is the discount rate that results in a value of zero for the present value of the discounted pre-tax cash flows up to Year N:



$$NPV = \sum_{n=0}^N \frac{C_n}{(1 + IRR)^n} = 0$$

Where  $C_{AfterTax,n}$  is the after-tax cash flow described above.

### Project after-tax cumulative NPV

The cumulative net present value in a given Year N is the sum of the present values of the pre-tax cash flows up to Year N:

$$NPV = \sum_{n=0}^N \frac{C_{AfterTax,n}}{(1 + d_{nominal})^n}$$

Where  $C_{AfterTax,n}$  is the after-tax cash flow described above, and  $d_{nominal}$  is the nominal discount rate from the [Financial Parameters](#) page.

### Project LCOE

SAM reports quantities used in the LCOE calculation in the cash flow table for reference. For a description of the LCOE see [Levelized Cost of Energy \(LCOE\)](#).

#### Project PPA revenue

The total PPA revenue is the project's annual revenue from electricity sales, not accounting for salvage value:

$$Project\ PPA\ Revenue = Net\ Energy\ (kWh) \times PPA\ Price\ (cents/kWh) \div 100\ (cents/\$)$$

#### Net Energy (kWh)

The total amount of electricity generated by the system in AC kilowatt-hours for each year. See description above

#### NPV of PPA revenue

The present value of the annual PPA revenue streams over the analysis period used as the numerator of the LCOE equation:

$$NPV(\text{Revenue}) = \sum_{n=0}^N \frac{R_{PPA,n}}{(1 + d_{nominal})^n}$$

Where  $R_{PPA,n}$  is the revenue from electricity sales-tax cash flow described above, and  $d_{nominal}$  is the nominal discount rate from the [Financial Parameters](#) page.

#### NPV of net annual energy (nominal)

The LCOE calculation requires a discounted energy term in the denominator. The value discounted using the nominal discount rate is for the nominal LCOE equation.

$$NPV(\text{Energy Nominal}) = \sum_{n=0}^N \frac{Q_n}{(1 + d_{nominal})^n}$$

Where  $Q_n$  is the annual energy value described above, and  $d_{nominal}$  is the nominal discount rate from the [Financial Parameters](#) page.

**Project Nominal LCOE**

$$\text{Project Nominal LCOE} = \text{NPV(Revenue)} / \text{NPV(Energy Nominal)}$$

**NPV of net annual energy (real)**

The LCOE calculation requires a discounted energy term in the denominator. The value discounted using the real discount rate is for the real LCOE equation.

$$\text{NPV(Energy Real)} = \sum_{n=0}^N \frac{Q_n}{(1 + d_{real})^n}$$

Where  $Q_n$  is the annual energy value described above, and  $d_{real}$  is the nominal discount rate from the [Financial Parameters](#) page.

**Project Real LCOE**

$$\text{Project Real LCOE} = \text{NPV(Revenue)} / \text{NPV(Energy Real)}$$

**Incentives**

[Incentives](#) may consist of either cash incentives (IBI, CBI, PBI) or tax credits (ITC, PTC), and may either calculated based on project investment costs (IBI, CBI, ITC), or the project's energy production (PBI, PTC).

The values in the incentives rows of the cash flow table are shown for reference. Their impact on project cash flows are shown in the project cash flows described above:

- PBI income appears under **Cash Flows from Operating Activities**.
- IBI and CBI income appear under **Cash Flows from Investing Activities**.
- ITC and PTC amounts appear under after-tax project returns.

The incentive cash flow rows show the value of cash incentives and tax credits, which are used to calculate cash flows described above.

**IBI (Investment Based Incentives)**

Each IBI (federal, state, utility, other) applies in Year Zero of the project cash flow.

Because you can specify each IBI on the [Incentives](#) page as either an amount or a percentage, SAM calculates the value of each IBI as the sum of two values:

$$\text{IBI as Amount} = \text{Amount}$$

$$\text{IBI as Percentage} = \text{Total Installed Cost (\$)} \times \text{Percentage (\%)}, \text{ up to Maximum}$$

$$\text{IBI in Year 0} = \text{IBI as Amount} + \text{IBI as Percentage}$$

Where *Amount*, *Percentage* and *Maximum* are the values that you specify on the [Incentives](#) page, and *Total Installed Cost* is from the [System Costs](#) page.

*Total IBI* is the sum of the four IBI values (federal, state, utility, other).

**Note.** The IBI amount reduces the after tax cost flow in Year Zero, and the debt balance in Year One. This is because SAM assumes that debt payments begin in Year One, when the project is generating or saving electricity.

**CBI (Capacity Based Incentives)**

Each CBI (federal, state, utility, other) applies in Year Zero of the project cash flow:

$$\text{CBI in Year 0} = \text{System Capacity (W)} \times \text{Amount (\$/W)}, \text{ up to Maximum}$$

Where System Capacity is the rated capacity of the system, and *Amount* and *Maximum* are the values you specify on the [Incentives](#) page.

*Total CBI* is the sum of the four CBI values (federal, state, utility, other).

The system nameplate capacity depends on technology being modeled. SAM converts the capacity value to the appropriate units (MW, kW, or W) before using it in calculations. For the photovoltaic models, the capacity is a DC power rating, and for the others it is an AC power rating. For the Solar Water Heating Model, the capacity is a thermal rating, while for the others it is an electric rating.

**Table 16. Nameplate system capacity values for each technology.**

Performance Model	System Capacity	Input Page
Detailed photovoltaic (DC)	Total Array Power (Wdc)	<a href="#">Array</a>
PVWatts (DC)	DC Rating (kWdc)	<a href="#">PVWatts Solar Array</a>
High concentration photovoltaic (DC)	System Nameplate Capacity	<a href="#">Array</a>
CSP Parabolic Trough - Physical (AC)	Estimated Net Output at Design (Nameplate) (MWe)	<a href="#">Power Cycle</a>
CSP Parabolic Trough - Empirical (AC)	Estimated Net Output at Design (MWe)	<a href="#">Power Block</a>
CSP Molten Salt Power Tower (AC)	Estimated Net Output at Design (Nameplate) (MWe)	<a href="#">Power Cycle</a>
CSP Generic Solar (AC)	Estimated Net Output at Design (Nameplate) (MWe)	<a href="#">Power Block</a>
CSP Linear Fresnel (AC)	Net nameplate capacity (MWe)	<a href="#">Power Cycle</a>
Generic System (AC)	Nameplate Capacity (kWe)	<a href="#">Power Plant</a>
Geothermal	Net Plant Output (MWe)	<a href="#">Plant and Equipment</a>
Water Heating Model (Thermal)	Nameplate Capacity (kWt)	<a href="#">SWH System</a>
Wind Power (AC)	System Nameplate Capacity (kWe)	<a href="#">Wind Farm</a>
Biopower (AC)	Nameplate Capacity, Gross (kWe)	<a href="#">Plant Specs</a>

#### **PBI (Performance Based Incentive)**

Each PBI (federal, state, utility, other) applies in Years One and later of the project cash flow, up to the number of years you specify:

$$PBI \text{ in Year } n = \text{Amount } (\$/kWh) \times \text{Energy in Year } n \text{ (kWh)} \times (1 + \text{Escalation})^{(n-1)}, \text{ up to Term}$$

Where *Amount*, *Term*, and *Escalation* are the values you specify on the [Incentives](#) page, and *Energy* is the value displayed in Energy row of the cash flow table (described above).

**Note.** If you use an annual schedule to specify year-by-year PBI amounts, SAM ignores the escalation rate.

*Total PBI* is the sum of the four PBI amounts (federal, state, utility, other).

**Important Note!** If you specify a PBI amount on the Cash Incentives page, be sure to also specify the incentive term. If you specify a term of zero, the incentive will not appear in the cash flow table.

### PTC (Production Tax Credit)

The state and federal PTC each apply in Year One and later of the project cash flow, up to the number of years you specify:

$$PTC \text{ in Year } n = \text{Amount } (\$/kWh) \times (1 + \text{Escalation})^{(n-1)} \times \text{Energy in Year } n \text{ (kWh)}$$

Where *Amount*, *Term*, and *Escalation* are the values you specify on the [Incentives](#) page, and *Energy* is the value displayed in the Energy row of the cash flow table (described above).

SAM rounds the product  $\text{Amount } (\$/kWh) \times (1 + \text{Escalation})^{(n-1)}$  to the nearest multiple of 0.1 cent as described in Notice 2010-37 of [IRS Bulletin 2010-18](#).

**Note.** If you specify year-by-year PTC rates on the Incentives page using an Annual Schedule instead of a single value, SAM ignores the PTC escalation rate.

### ITC (Investment Tax Credit)

The state and federal ITC each apply only in Year One of the project cash flow. For ITCs that you specify as a fixed amount:

$$ITC \text{ in Year One} = \text{Amount}$$

Where *Amount* is the value you specify in the [Incentives](#) page.

For ITCs that you specify as a percentage of total installed costs:

$$ITC \text{ in Year One} = ( \text{Total Installed Cost } (\$) - \text{ITC Basis Reduction } (\$) ) \times \text{Percentage } (\%), \text{ up to Maximum}$$

Where *Total Installed Cost* is from the [System Costs](#) page, and *Percentage* and *Maximum* are the values you specify on the [Incentives](#) page.

*ITC Basis Reduction* applies only to the Commercial and PPA financial models, and depends on whether the project includes any investment-based incentives (IBI) or capacity-based incentives (CBI) specified on the [Incentives](#) page with checked boxes under **Reduces Depreciation and ITC Bases**. For each IBI or CBI with a check mark, SAM subtracts the incentive amount from the total installed cost to calculate the ITC.

$$ITC \text{ Basis Reduction} = IBI + CBI$$

Where *IBI* and *CBI* are the incentives that you have specified reduce the ITC basis on the [Incentives](#) page.

## Debt

The debt amounts depend on the following inputs from the [Financial Parameters](#) page:

- Debt Rate
- DSCR

## Debt Repayment

The debt repayment rows show the size of annual debt payments.

## Debt Sizing (Constant Payments)

When you specify the debt percent as an input on the Financial Parameters page, SAM assumes constant total annual debt payments so that the annual debt service coverage ratio (DSCR) varies from year to year. In this mode, SAM reports the minimum DSCR in the Metrics table.

## Debt Sizing (Constant DSCR)

When you specify the DSCR as an input on the Financial Parameters page, SAM assumes a constant annual DSCR and sculpted debt, where annual debt payments vary to match cash available for debt services. In this mode, SAM reports the debt percent in the Metrics table.

## Reserve Accounts

Reserve accounts include debt service, working capital reserve, and major equipment replacement reserves. The reserve account amounts depend on the following inputs from the Financial Parameters page:

- Inflation Rate
- Debt Service Reserve Account (months P&I)
- Working Capital Reserve Months of Operating Costs
- Major Equipment Replacement Reserve Account [1-3] Frequency (years)
- Major Equipment Replacement [1-3] (Year 1 \$)

### Lease Payment Reserve (Sale Leaseback only)

$$\text{Lease Payment Reserve} = \text{Tax Investor (Lessor) Required Lease Payment Reserve (months)} \div 12 \times \text{Total Developer Pre-tax Cash Flow from Operating Activities in Year } n+1$$

### Debt Service Reserve

The debt service reserve applies in Year Zero and later:

$$\text{Debt Service Reserve} = \text{Debt Service Reserve Account (months P\&I)} \div 12 \times \text{Total P\&I in Year } n+1$$

Where *Debt Service Reserve Account (months P&I)* is from the Financial Parameters page, and *Total P&I in Year n+1* is described under Debt above.

### Working Capital Reserve

Working capital reserve applies in Year Zero and later:

$$\text{Working Capital Reserve} = \text{Months of Operating Costs} \times \text{Operating Expenses in Year } n+1$$

Where *Months of Operating Costs* is from the Financial Parameters page, and *Operating Expenses in Year n+1* is described above.

### Major Equipment Replacement Reserves

You can specify up to three major equipment reserve accounts on the Financial Parameters page. For each account, the amount applies in Year One and later of the cash flow:

$$\text{Major Equipment Reserve in Year } n = \text{Major Equipment Reserve in Year } n-1 + \text{Funding} + \text{Release of Funds}$$

Where Major Equipment Reserve in Year Zero = 0, and:

$$\text{Funding} = \text{Release of Funds in Year of Next Replacement} \div \text{Replacement Frequency}$$

$$\text{Release of Funds in Year of Next Replacement} = - \text{Replacement Cost in Year One } \$ \times (1 + \text{Inflation Rate})^{(n-1)}$$

Where *Replacement Frequency*, *Replacement Cost in Year One \$*, and *Inflation Rate* are from the Financial Parameters page

## Depreciation and ITC (State and Federal)

The federal and state Depreciation and ITC tables show the depreciable basis calculation for each of the up to seven depreciation classes for federal and state tax purposes:

- The total depreciable amount includes the total installed cost, development fee, equity closing cost, debt service reserve, working capital reserve, and for the Sale Leaseback financial model, the lease payment reserve.
- The depreciation class allocations on the [Financial Parameters](#) page determine how the depreciable basis is allocated to the different depreciation classes (MACRS 5-yr, Straight Line, etc.).
- For each state and federal IBI and CBI with **Reduces Depreciation and ITC Bases** checked on the [Incentives](#) page, the full incentive amount reduces the depreciable basis.
- For each state and federal ITC with **Reduces Depreciation Basis** checked on the [Incentives](#) page, 50% of the tax credit amount reduces the depreciable basis.
- For each depreciation class with a checked box under **Bonus Depreciation** on the Financial Parameters page, the depreciable basis is the product of the bonus depreciation percentage and the adjusted depreciable basis. (The adjusted depreciable basis is the total depreciable after incentives and tax credit adjustments.)
- For state and federal taxes, depreciation for major equipment replacement reserves uses the class specified on the Financial Parameters page.

The depreciation amounts depend on the total installed cost from the [System Costs](#) page, and the following inputs from other pages.

From the Financial Parameters page:

- Development Fee
- Debt Closing Costs
- Debt Closing Fee
- Equity Closing Cost
- Construction Financing
- Other Financing Cost

From the [Incentives](#) page:

- State ITC as Percentage
- State ITC Maximum
- State ITC as Amount
- Federal ITC as Percentage
- Federal ITC Maximum
- Federal ITC as Amount
- Status of **Reduces Depreciation Basis** check boxes
- The amounts and percentages of any incentive with **Reduces Depreciation and ITC Bases** checked

From the [Depreciation](#) page:

- Allocations for each depreciation class
- Bonus depreciation amounts and applicable depreciation classes

- ITC qualification status of depreciation classes

The depreciation amounts also depend on the following cash flow values:

- Debt service reserve
- Working capital reserve
- IBI (only for incentives shown to reduce depreciation basis on Incentives page)
- CBI (only for incentives shown to reduce depreciation basis on Incentives page)
- Debt funding
- For state depreciation, the federal ITC basis disallowance amounts for each depreciation class
- For federal depreciation, the state ITC basis disallowance amounts for each depreciation class

### Gross Depreciable Basis with IBI and CBI Reductions Before ITC Reductions

For each depreciable class, the depreciable basis before reduction by the ITC is the gross depreciable basis less IBI and CBI amounts for incentives on the Cash Incentives page with **Reduces Depreciation and ITC Bases** checked.

**Note.** The IBI and CBI reduce the depreciation basis for state taxes only when **State** under **Reduces Depreciation and ITC Bases** is checked. Similarly, the IBI and CBI reduce the depreciation basis for federal taxes only when **Federal** under **Reduces Depreciation and ITC Bases**.

#### % of Total Depreciable Basis

The normalized allocation for each depreciation class allocation:

$$\% \text{ of Total Depreciable Basis} = \text{Allocation} \div \text{Sum of Allocations}$$

Where *Allocation* is the percentage for the given depreciable class, and *Sum of Allocations* is the sum of all allocations from the Financial Parameters page.

#### Gross Amount Allocated

The gross depreciable basis before reductions for each depreciation class:

$$\text{Gross Amount Allocated} = \% \text{ of Total Depreciable Basis} \times \text{Total Depreciable Amount}$$

Where % of Total Depreciable Basis is described above, and

$$\text{Total Depreciable Amount} = \text{Total Installed Cost} + \text{Development Fee} + \text{Equity Closing Cost} + \text{Debt Closing Costs} + \text{Debt Closing Fee} \times \text{Funding} + \text{Debt Service Reserve} + \text{Working Capital Reserve} + \text{Lease Payment Reserve}$$

Where *Total Installed Cost* is from the [System Costs](#) page; *Development Fee*, *Equity Closing Cost*, *Debt Closing Costs*, and *Debt Closing Fee* are from the [Financial Parameters](#) page; and *Debt Service Reserve*, *Working Capital Reserve* and *Lease Payment Reserve* (Sale Leaseback financial model only) are other values in the cash flow described above

#### Reduction: IBI

The reduction in depreciation basis from IBI payments:

$$\text{Reduction IBI} = \text{Total IBI that Reduce Depreciation} \times \% \text{ of Total Depreciable Basis}$$

Where *Total IBI that Reduce Depreciation* is the sum of IBI values in the cash flow for incentives with **Reduces Depreciation and ITC Bases** checked on the [Incentives](#) page. For the state depreciation table, **State** must be checked for the incentive to reduce the state depreciation basis. For the federal depreciation table, **Federal** must be checked. % of Total Depreciable Basis is the allocation for the depreciation class described above.

**Reduction: CBI**

The reduction in depreciation basis from CBI payments:

$$\text{Reduction CBI} = \text{Total CBI that Reduce Depreciation} \times \% \text{ of Total Depreciable Basis}$$

Where *Total CBI that Reduce Depreciation* is the sum of CBI values in the cash flow for incentives with **Reduces Depreciation and ITC Bases** checked on the [Incentives](#) page. For the state depreciation table, **State** must be checked for the incentive to reduce the state depreciation basis. For the federal depreciation table, **Federal** must be checked. *% of Total Depreciable Basis* is the allocation for the depreciation class described above.

**Depreciable Basis Prior to ITC**

The depreciable basis reduced by CBI and IBI amounts:

$$\text{Depreciable Basis Prior to ITC} = \text{Gross Amount Allocated} - \text{Reduction: IBI} - \text{Reduction: CBI}$$

**ITC Reduction**

For each ITC on the [Incentives](#) page with **Reduces Depreciation Basis** checked, 50% of the ITC amount can be included in the depreciable basis for each depreciable class with **ITC Qualification** checked on the [Depreciation](#) page. SAM calculates the ITC reduction amount for ITCs that you specify on the Incentives page a percentage of the total installed costs with a maximum amount, and ITCs that you specify as a fixed amount.

**Note.** The ITC reduces the depreciation basis for state taxes only when **State** under **Reduces Depreciation Basis** is checked on the [Incentives](#) page, and when **State** is checked under **ITC Qualification** for the depreciation class on the [Depreciation](#) page. Similarly, the ITC reduces the depreciation basis for federal taxes only when **Federal** is checked under **Reduces Depreciation Basis** and under **ITC Qualification** for the depreciation class.

For each ITC specified as a percentage and maximum on the Incentives page, the *ITC Basis Disallowance* is the amount that may be available for depreciation basis reduction. (The ITC Reduction amounts are the amounts actually available.):

**ITC Qualifying Costs**

For depreciation classes with **ITC Qualification** checked on the [Depreciation](#) page:

$$\text{ITC Qualifying Costs} = \text{Depreciable Basis Prior to ITC}$$

**% of ITC Qualifying Costs**

For each depreciable class:

$$\% \text{ of ITC Qualifying Costs} = \text{ITC Qualifying Costs} \div \text{Total Depreciable Basis Prior to ITC}$$

Where *Total Depreciable Basis Prior to ITC* is the sum of *Depreciable Basis Prior to ITC* for all depreciable classes.

**ITC Amount**

$$\text{ITC Amount} = \% \text{ of ITC Qualifying Costs} \times \text{ITC Qualifying Costs}$$

**ITC Basis Disallowance**

The ITC depreciation basis disallowance is 50% of the ITC amount:

$$\text{ITC Basis Disallowance} = \text{ITC Amount} \times 0.5$$

For each ITC specified as a fixed amount on the Incentives page, the ITC Basis Disallowance is the amount that may be available for depreciation basis reduction. (The ITC Reduction amounts are the amounts



actually available.):

### ITC Amount

For each depreciable class, the Total ITC Amount is the amount that may be available for depreciation reduction:

$$ITC\ Amount = Total\ ITC\ Amount \times \% \text{ of ITC Qualifying Costs}$$

Where, for the state depreciation table, *Total ITC Amount* is the state ITC amount from the [Incentives](#) page. For the federal depreciation table, *Total ITC Amount* is the federal ITC amount from the Incentives page.

### ITC Basis Disallowance

The ITC depreciation basis disallowance is 50% of the ITC amount:

$$ITC\ Basis\ Disallowance = ITC\ Amount \times 0.5$$

The depreciable basis after ITC reduction is the sum of the total ITC basis disallowance values for the ITCs with **Reduces Depreciation Basis** checked on the Incentives pages.

### ITC Reduction: State

$$ITC\ Reduction: State = ITC\ Basis\ Disallowance\ (ITC\ as\ \%) + ITC\ Basis\ Disallowance\ (ITC\ as\ Fixed\ Amount)$$

Where the ITC basis disallowance values are from the state depreciation table for the ITCs that reduce depreciation basis.

### ITC Reduction: Federal

$$ITC\ Reduction: Federal = ITC\ Basis\ Disallowance\ (ITC\ as\ \%) + ITC\ Basis\ Disallowance\ (ITC\ as\ Fixed\ Amount)$$

Where the ITC basis disallowance values are from the federal depreciation table for the ITCs that reduce depreciation basis.

### Depreciable Basis after ITC Reduction

$$Depreciable\ Basis\ after\ ITC\ Reduction = Depreciable\ Basis\ Prior\ to\ ITC - ITC\ Reduction:State - ITC\ Reduction:Federal$$

## Bonus Depreciation

For each depreciation class that qualifies for bonus depreciation as indicated by the check boxes under Bonus Depreciation on the [Depreciation](#) page, bonus depreciation percentage applies to the depreciable basis.

**Note.** The bonus depreciation percentage applies to the depreciation basis for state taxes only when **State** under **Bonus Depreciation** is checked. Similarly, the bonus depreciation percentage applies for federal taxes only when **Federal** under **Reduces Depreciation Basis** is checked.

### First Year Bonus Depreciation

For each depreciation class with **Bonus Depreciation** checked on the Depreciation page:

$$First\ Year\ Bonus\ Depreciation = Depreciable\ Basis\ after\ ITC\ Reduction \times Bonus\ Depreciation\ Percentage$$

Where Bonus Depreciation Percentage is from the Depreciation page: The state bonus percentage applies to the state depreciation table, and the federal percentage applies to the federal depreciation table.

## Depreciable Basis

The depreciable basis after IBI, CBI, ITC and bonus depreciation reduction is the basis to which the depreciation percentages defined by the depreciation class apply.

$$\text{Depreciable Basis after Bonus Reduction} = \text{Depreciable Basis after ITC Reduction} - \text{First Year Bonus Depreciation}$$

The following table shows the depreciation percentage by year for each depreciation class. For each depreciation class, the percentage is applied to the depreciable basis amount for the given year in the cash flow:

Years 1-10	1	2	3	4	5	6	7	8	9	10
5-yr MACRS	20.0	32.0	19.2	11.5	11.5	5.8				
15-yr MACRS	5.0	9.5	8.6	7.7	6.9	6.2	5.9	5.9	5.9	5.9
5-yr SL	10.0	20.0	20.0	20.0	20.0	10.0				
15-yr SL	3.3	6.7	6.7	6.7	6.7	6.7	6.7	6.7	6.7	6.7
20-yr SL	2.5	5.0	5.0	5.0	5.0	5.0	5.0	5.0	5.0	5.0
39-yr SL	1.3	2.6	2.6	2.6	2.6	2.6	2.6	2.6	2.6	2.6
Years 11-20	11	12	13	14	15	16	17	18	19	20
15-yr MACRS	5.9	5.9	5.9	5.9	5.9	3.0				
15-yr SL	6.7	6.7	6.7	6.7	6.7	3.3				
20-yr SL	5.0	5.0	5.0	5.0	5.0	5.0	5.0	5.0	5.0	5.0
39-yr SL	2.6	2.6	2.6	2.6	2.6	2.6	2.6	2.6	2.6	2.6
Years 21-30	21	22	23	24	25	26	27	28	29	30
20-yr SL	2.5									
39-yr SL	2.6	2.6	2.6	2.6	2.6	2.6	2.6	2.6	2.6	2.6
Years 31-40	31	32	33	34	35	36	37	38	39	40
39-yr SL	2.6	2.6	2.6	2.6	2.6	2.6	2.6	2.6	2.6	1.3

## 34.3 All Equity Partnership Flip

This topic describes the [cash flow](#) table generated by the financial model for the All Equity Partnership Flip financial model. See [Financial Models](#) for details.

SAM offers three options for exporting cash flow data:

- **Copy to clipboard** copies the table to your clipboard. You can paste the entire table into a word processing document, spreadsheet, presentation or other software.
- **Save as CSV** saves the table in a comma-delimited text file that you can open in a spreadsheet program or text editor.
- **Send to Excel** (Windows only) creates an Excel workbook that contains the data from the cash flow, but no formulas.

- **Send to Excel with Equations** (Windows only) exports the cash flow data to an existing Excel workbook that contains formulas to illustrate how SAM's internal cash flow calculations work. The workbooks are in the *runtime\spreadsheets* folder of your [SAM installation folder](#).

**Notes.**

SAM makes cash flow calculations internally during the simulation. It does not use Excel to make the calculations. The two **Send to Excel** options are to help you analyze the cash flow data and understand how SAM's internal calculations work.

You can also display cash flow data by building a [data](#) table.

## Production

### Energy Values for Financial Models Except Single Owner

**Energy, kWh**

For systems that generate electricity, the total amount of electricity generated by the system in AC kilowatt-hours for each year.

For solar water heating systems, the total amount of electricity saved by the solar water heating system in AC kilowatt-hours for each year.

### Energy Values for the Single Owner Financial Model

**Energy to grid, kWh**

Total AC electricity delivered to the grid by the power system in each year of the analysis period, including electricity from battery storage if applicable.

This value is the sum of the hourly or subhourly Electricity to grid values.

**Energy from grid, kWh**

Total grid AC electricity consumed by the power system in each year to meet loads for inverter night-time consumption, battery charging, and freeze protection and other parasitic loads for concentrating power systems.

This value is the sum of hourly or subhourly Electricity from grid values.

**Net energy to grid, kWh**

The total net AC electricity delivered to the grid by the power system in each year of the analysis period. For projects with a fixed power price, this is the value used to determine project revenue. For projects with time-of-delivery (TOD) power price multipliers, the revenue is calculated on a time-step basis.

## Energy and Degradation

For Year One of the project cash flow, the energy values are calculated the performance model

$$\text{Energy in Year One} = \text{Sum of Hourly or Sub-hourly Values}$$

Where Sum of Hourly or Sub-hourly Values is the system's total annual electrical output (or energy saved), equal to the sum of the values calculated by the performance model (8,760 values for hourly simulations).

For Years 2 and later:

$$\text{Energy in Year } n > 1 = \text{Energy in Year } n-1 \times (1 - \text{degradation rate})$$

Where Energy in Year n-1 is the previous year's energy value and degradation rate is from the [Lifetime](#) page.

**Note.** If you specified **degradation rate** on the [Lifetime](#) page using the [annual schedule](#) option, SAM applies the value as follows:

$$\text{Energy in Year } n > 1 = \text{Energy in Year } 1 \times (1 - \text{degradation rate} \div 100\%)$$

## Revenue

### PPA price (cents/kWh)

The PPA price in Year One is either the value you specify on the [Financial Parameters](#) page, or the value calculated by SAM to meet the IRR target you specify on the Financial Parameters page. The PPA price in Year One is the PPA price:

$$\text{PPA Price in Year One} = \text{Adjusted PPA Price}$$

For analyses that do not involve time-dependent pricing, *Adjusted PPA Price* is equal to the [PPA Price](#) reported on the [Metrics table](#).

For analyses that do involve time-dependent pricing, for each hour of the year, SAM multiplies the [PPA price](#) shown in the [Metrics table](#) (equivalent to the bid price) by the TOD factor for that hour to calculate a set of hourly energy prices for Year one. The *Adjusted PPA Price* is the average of the 8,760 hourly values.

#### Notes.

When you choose **Specify PPA Price** for **Solution Mode** on the Financial Parameters page, the [PPA Price](#) in the [Metrics table](#) is equal to the price you specify. When you choose **Specify IRR Target**, SAM calculates the PPA price required to meet the IRR target that you specify.

The TOD factors are on the Thermal Energy Storage page for CSP systems (parabolic trough, power tower, linear Fresnel, generic solar system), and on the [Revenue](#) page for photovoltaic and other systems.

To remove time-dependent pricing from your analysis, set the TOD factor for each of the 9 periods to one. Where *Adjusted PPA Price* is either the value you specify on the Financial Parameters page, or a value calculated to cover project costs based on the target IRR you specify on the [Financial Parameters](#) page, adjusted by the time-of-delivery (TOD) factors.

In Years Two and later:

$$\text{PPA Price in Year } n > 1 = \text{PPA Price in Year } n-1 \times (1 + \text{PPA Escalation Rate})^{(n-1)}$$

Where *PPA Escalation Rate* is from the [Financial Parameters](#) page.

**Note.** SAM uses the PPA Price to calculate the [levelized cost of energy](#).

## Revenue for PPA Single Owner Financial Model

The Single Owner financial model reports three revenue values in the project cash flow.

### PPA revenue gross

The gross project revenue earned from electricity sales. For a project with a PPA price that does not

vary with time of delivery, this is the net annual energy to grid in kWh multiplied by the PPA price in \$/kWh.

#### PPA revenue lost to self-consumption

Revenue lost to grid power purchases to meet power system self-consumption loads such as inverter nighttime power consumption for photovoltaic systems, and freeze protection power and other parasitic loads for concentrating power systems.

For systems for battery storage, when the option on the [Electricity Rates](#) page is **No Electricity Rate**, revenue lost to self-consumption also includes power for battery charging.

#### PPA revenue net

The net revenue earned from electricity sales, accounting for revenue lost do self-consumption.

### Revenue for PPA Partnership and Sale Leaseback Models

#### PPA revenue to project

The project's annual revenue from electricity sales, not accounting for salvage value:

$$\text{Total PPA Revenue} = \text{Net Energy (kWh)} \times \text{PPA Price (cents/kWh)} \times 0.01 (\$/cents)$$

#### Salvage value

SAM calculates the net salvage value using the percentage you specify on the [Financial Parameters](#) page and the total installed cost from the System Costs page. The salvage value applies in the final year of the project cash flow.

For example, if you specify a 10% salvage value for a project with a 30-year analysis period, and total installed cost of \$1 million, SAM includes income in Year 30 of  $\$100,000 = \$1,000,000 \times 0.10$ .

SAM adds the salvage value as income (a negative value) to the operating expenses in the cash flow in the final year of the analysis period. The salvage value therefore reduces the operating expenses in the final year of the analysis period.

For residential projects, the salvage value has no effect on federal and state income tax because operating expenses are not taxable.

For commercial projects, because the salvage value reduces the operating expenses in the final year of the analysis period, it increases the federal and state income tax payment because operating expenses are deductible from federal and state income tax.

#### Total revenue to project

The projects annual revenue, accounting for salvage value.

$$\text{Total Revenue} = \text{Total PPA Revenue} + \text{Salvage Value}$$

Because Salvage Value is zero for all years except the last year of the analysis period, the Total Revenue and Total PPA Revenue are the same for all years except for the last year.

For the Single Owner and Leveraged Partnership Flip financial models (both of which include debt), total revenue may also include production-based [incentive](#) (PBI) amounts. For each PBI amount that you check on the [Financial Parameters](#) page under **Debt Service, Production Based Incentives (PBI) Available for Debt Service**, SAM displays a row for the PBI above the Total Revenue row, and includes the amount in the Total Revenue amount:

$$\text{Total Revenue} = \text{Total PPA Revenue} + \text{Salvage Value} + \text{PBI}$$

## Expenses

The eight expense rows are for annual project costs calculated from assumptions you specify on the [Financial Parameters](#) and [System Costs](#) pages.

The four O&M expenses are based on the first year or annual schedule costs you specify under Operation and Maintenance Costs on the [System Costs](#) page, and are adjusted by the inflation rate from the [Financial Parameters](#) page and optional escalation rate from the System Costs page.

### O&M Fixed expense

$$\text{O\&M Fixed Expense in Year } n = \text{Fixed Annual Cost (\$)} \times (1 + \text{Inflation Rate} + \text{Escalation Rate})^{n-1}$$

Where *Fixed Annual Cost* is from the [System Costs](#) page, and *Inflation Rate* and *Escalation Rate* are from the [Financial Parameters](#) page.

### O&M Capacity-based expense

$$\text{O\&M Capacity-based Expense in Year } n = \text{Fixed Cost by Capacity (\$/kW-yr)} \times \text{System Rated Capacity} \times (1 + \text{Inflation Rate} + \text{Escalation Rate})^{(n-1)}$$

Where *Fixed Cost by Capacity* is from the [System Costs](#) page, and *Inflation Rate* and *Escalation Rate* are from the [Financial Parameters](#) page.

The system nameplate capacity depends on technology being modeled. SAM converts the capacity value to the appropriate units (MW, kW, or W) before using it in calculations. For the photovoltaic models, the capacity is a DC power rating, and for the others it is an AC power rating. For the Solar Water Heating Model, the capacity is a thermal rating, while for the others it is an electric rating.

**Table 17. Nameplate system capacity values for each technology.**

Performance Model	System Capacity	Input Page
Detailed photovoltaic (DC)	Total Array Power (Wdc)	<a href="#">Array</a>
PVWatts (DC)	DC Rating (kWdc)	<a href="#">PVWatts Solar Array</a>
High concentration photovoltaic (DC)	System Nameplate Capacity	<a href="#">Array</a>
CSP Parabolic Trough - Physical (AC)	Estimated Net Output at Design (Nameplate) (MWe)	<a href="#">Power Cycle</a>
CSP Parabolic Trough - Empirical (AC)	Estimated Net Output at Design (MWe)	<a href="#">Power Block</a>
CSP Molten Salt Power Tower (AC)	Estimated Net Output at Design (Nameplate) (MWe)	<a href="#">Power Cycle</a>
CSP Generic Solar (AC)	Estimated Net Output at Design (Nameplate) (MWe)	<a href="#">Power Block</a>
CSP Linear Fresnel (AC)	Net nameplate capacity (MWe)	<a href="#">Power Cycle</a>
Generic System (AC)	Nameplate Capacity (kWe)	<a href="#">Power Plant</a>
Geothermal	Net Plant Output (MWe)	<a href="#">Plant and Equipment</a>
Water Heating Model (Thermal)	Nameplate Capacity (kWt)	<a href="#">SWH System</a>
Wind Power (AC)	System Nameplate Capacity (kWe)	<a href="#">Wind Farm</a>
Biopower (AC)	Nameplate Capacity, Gross (kWe)	<a href="#">Plant Specs</a>

**O&M Production-based expense**

$$O\&M \text{ Production-based Expense in Year } n = \text{Variable Cost by Generation } (\$/MWh) \times \text{Net Energy in Year } n \text{ (MWh)} * (1 + \text{Inflation Rate} + \text{Escalation Rate})^{(n-1)}$$

Where *Variable Cost by Generation* is from the [System Costs](#) page, *Net Energy* is described above, and *Inflation Rate* and *Escalation Rate* are from the [Financial Parameters](#) page.

**O&M Fuel expense**

The following performance models include a fuel cost calculation:

- Parabolic trough ([physical](#) or [empirical](#)) with fossil backup
- [Power tower](#) with fossil backup
- [Generic solar](#) system with fossil backup
- [Generic system](#) for the primary fuel cost
- [Biomass Power](#) for biomass and supplementary coal feedstock costs

**Note.** For the CSP systems listed above, SAM only considers the system to have a fossil-fired backup boiler when the fossil fill fraction variable on the Thermal Storage page is greater than zero.

For solar and generic systems listed above that consume a fuel, Fuel O&M is the annual fuel cost:

$$\text{Fuel O\&M in Year } n = \text{Annual Fuel Usage in Year One (kWh)} \times 0.003413 \text{ MMBtu per kWh} \times \text{Fossil Fuel Cost (\$/MMBtu)} \times (1 + \text{Inflation Rate} + \text{Escalation Rate})^{(n-1)}$$

Where *Annual Fuel Usage in Year One* is the quantity of fuel consumed in Year One calculated by the performance model. *Fossil Fuel Cost* and *Escalation Rate* are from the [System Costs](#) page, and *Inflation Rate* is from the [Financial Parameters](#) page.

**Note.** When you specify fuel costs using an annual schedule instead of a single value, SAM does not apply the inflation rate or escalation rate to the values you specify for each year.

For the [biomass power](#) model, SAM calculates feedstock and coal costs using feedstock usage and price values from the [Feedstock Costs](#) page:

$$\text{Biomass Feedstock Costs in Year } n = \text{Total Biomass Fuel Usage in Year One (dry tons/year)} \times \text{Biomass Fuel Cost (\$/dry ton)} \times (1 + \text{Inflation Rate} + \text{Escalation Rate})^{(n-1)}$$

$$\text{Coal Feedstock Costs in Year } n = \text{Total Coal Fuel Usage in Year One (dry tons/year)} \times \text{Coal Fuel Cost (\$/dry ton)} \times (1 + \text{Inflation Rate} + \text{Escalation Rate})^{(n-1)}$$

Where the fuel usage and fuel costs are from the [Feedstock Costs](#) page, and *Inflation Rate* and *Escalation Rate* are from the [Financial Parameters](#) page.

### Insurance expense

The insurance cost applies in Year One and later of the cash flow:

$$\text{Insurance in Year } n = \text{Total Installed Costs (\$)} \times \text{Insurance (\%)} \times (1 + \text{Inflation Rate})^{(n-1)}$$

Where *Total Installed Costs* is the value from the [System Costs](#) page, and *Insurance* and *Inflation Rate* are specified on the [Financial Parameters](#) page.

### Property tax net assessed value

The property assessed value is the value SAM uses as a basis to calculate the annual property tax payment:

$$\text{Property Assessed Value in Year One} = \text{Assessed Value}$$

Where *Assessed Value* is from the [Financial Parameters](#) page.

In Years 2 and later, the property assessed value is the Year One value adjusted by the assessed value decline value from the Financial Parameters page:

$$\text{Property Assessed Value in Year } n > 1 = \text{Assessed Value in Year One} \times [1 - \text{Assessed Value Decline} \times (n-1)]$$

Where *Assessed Value Decline* is from the Financial Parameters page, expressed as a fraction instead of a percentage.

If the value of  $1 - \text{Assessed Value Decline} \times (n-1)$  for a given year is equal to zero or less, then the *Property Assessed Value* in that year is zero.

### Property tax expense

Property taxes apply in Year One and later of the cash flow:

$$\text{Property Taxes in Year } n = \text{Property Assessed Value in Year } n (\$) \times \text{Property Tax (\%)}$$

Where *Property Assessed Value* is described above, and *Property Tax* is from the [Financial Parameters](#) page.



**Annual Developer (Lessee LLC) Margin (Sale Leaseback only)**

$$\text{Annual Developer Margin in Year } n = \text{Developer Operating Margin} \times (1 + \text{Developer Margin Escalation})^{(n-1)}$$

Where *Developer Operating Margin* and *Developer Margin Escalation* are from the [Financing](#) page.

**Total operating expense**

The total operating expense is the sum of expenses:

$$\text{Total Operating Expense in Year } n = \text{O\&M Fixed Expense} + \text{O\&M Capacity-based Expense} + \text{O\&M Production-based Expense} + \text{O\&M Fuel Expense} + \text{Insurance Expense} + \text{Property Tax Expense}$$

**EBITDA (\$)**

Earnings before interest, taxes, depreciation and amortization:

$$\text{EBITDA} = \text{Total Revenue} - \text{Total Operating Expense}$$

Where *Total Revenue* and *Total Operating Expense* are described above.

**Cash Flow: Project**

The project cash flows include those from operating activities, investing activities, incentives, and issuance of equity. The pre-tax cash flow is the total project cash flow.

**Cash Flow from Operating Activities**

The cash flow from operating activities are the project earnings including interest on reserves and production-based incentives payments less interest paid on debt.

**EBITDA**

The earnings before interest, taxes, depreciation and amortization described above.

**Interest on reserves**

$$\text{Interest on Reserves} = \text{Total Reserves (\$)} \times \text{Interest on Reserves (\%)}$$

Where *Total Reserves* is the sum of *Major Equipment Reserves*, *Working Capital Reserve*, and *Debt Service Reserves*, and *Interest on Reserves* is from the [Financial Parameters](#) page.

**PBI (Federal, State, Utility, Other, Total)**

These values represent income from production-based incentive payments, calculated as described below under Incentives.

**Total project cash flow from operating activities**

$$\text{Total} = \text{EBITDA} + \text{Interest on Reserves} + \text{Total PBI} - \text{Interest}$$

**Cash Flow from Investing Activities****Purchase of property cost**

The purchase of property cost applies only in Year Zero of the cash flow. It is the sum of the total installed cost from the System Costs page and debt-related and financing costs from the Financial Parameters page less any investment-based incentives defined on the Incentives page:

$$\text{Purchase of Property Cost} = \text{Total Installed Cost} + \text{Debt Closing Costs}$$

- + Debt Up-front Fee
- + Financing Cost
- + Construction Financing Cost
- Total IBI
- Total CBI

The debt up-front fee is the product of the percent of total debt from the Financial Parameters page and the size of debt.

#### **(Increase)/Decrease in working capital reserve account**

The working capital reserve amount in Year Zero depends on the Months of Operating Costs from the [Financial Parameters](#) page and the Year One total operating expense:

$$\text{Capital Reserve in Year Zero} = \text{Total Operating Expense in Year One (\$)} \times \text{Months of Operating Costs (months)} \div 12 \text{ (months)}$$

In Year One and later:

$$\text{Capital Reserve in Year } n > 0 = \text{Capital Reserve in Year } n-1 \text{ (\$)} - \text{Total Operating Expense in Year } n \text{ (\$)} \times \text{Months of Operating Costs (months)} \div 12 \text{ (months)}$$

Where *Months of Operating Costs* is from the [Financial Parameters](#) page.

#### **(Increase)/Decrease in major equipment reserve accounts**

For each of the up to three major equipment reserve accounts that you specify on the [Financial Parameters](#) page, SAM calculates the annual amount required to ensure that sufficient funds are available in the replacement year to cover the replacement cost:

For example, in the example described below under Major Equipment Capital Spending, the annual increase in reserves is  $\$530,682/\text{year} = \$2,653,400 \div 5 \text{ years}$ .

$$\text{Increase in Major Equipment Reserve} = \text{Inflation Adjusted Replacement Cost in Replacement Year (\$)} \div \text{Replacement Year (year)}$$

The increase is shown in the cash flow as a negative value.

In the year that the replacement occurs (in this example, Year 5), the decrease in major equipment reserve account is  $\$2,122,727 = \$2,653,400 - \$430,682$ .

$$\text{Decrease in Major Equipment Reserve in Replacement Year} = \text{Inflation Adjusted Replacement Cost in Replacement Year} - \text{Increase in Major Equipment Reserve}$$

The decrease is shown in the cash flow as a positive value.

#### **Major equipment capital spending**

For each of the up to three major equipment reserve accounts that you specify on the [Financial Parameters](#) page, the inflation-adjusted amount is reported in the year that you specify.

For example, if you specify a \$2,500 (in Year One dollars) replacement cost with a 5 year replacement frequency, and an inflation rate of 1.5% on the Financial Parameters page, SAM reports a major equipment capital spending amounts in years 5, 10, 15 etc. For Year 5, the amount would be  $\$2,653,400 = \$2,500,000 \times (1 + 0.015)^4$ .

In each year that the replacement occurs:

$$\text{Capital Spending} = - \text{Replacement Cost (Year One \$)} \times (1 + \text{Inflation Rate})^{(\text{Replacement Year} - 1)}$$

The value is negative because it represents an expense or outflow.

#### **Total cash flow from investing activities**

The total cash flow from investing activities is the sum of purchase property cost, reserve account

deposits or withdrawals, and capital spending:

$$\text{Total in Year Zero} = \text{Purchase of Property Cost} + \text{Debt Service (increase)/decrease} + \text{Working Capital (increase)/decrease}$$

$$\text{Total in Year } n>0 = \text{Working Capital (increase)/decrease} + \text{Major Equipment (increase)/decrease} + \text{Reserve Capital Spending}$$

## Cash Flow from Financing Activities

Cash flows from financing activities include income from incentive payments, equity capital, and, for Single Owner and Leveraged Partnership Flip, debt capital.

### Total IBI

The total investment-based incentive amount, described below.

### Total CBI

The total capital-based incentive amount, described below.

### Equity Capital

The equity capital invested in the project.

$$\text{Issuance of Equity in Year Zero} = \text{Total Installed Cost} + \text{Financing Cost} - (\text{Debt Funding} + \text{Total IBI} + \text{Total CBI})$$

Where *Total Installed Cost* is the project capital cost from the [System Costs](#) page, *Financing Cost* is the total debt costs and development fees, *Debt* (Single Owner and Leveraged Partnership Flip only) is the debt funding amount described below, and *Total IBI* and *Total CBI* are the investment-based incentive and capacity based incentive amounts described below.

### Total project cash flow from financing activities

The total cash flow from financing activities is the sum of equity capital, incentive payments, and debt capital.

$$\text{Total in Year Zero} = \text{Issuance of Equity} + \text{Total IBI} + \text{Total CBI} + \text{Debt Funding}$$

$$\text{Total in Year } n>0 = \text{Debt Repayment}$$

### Project total pre-tax cash flow

The pre-tax cash flow is the cash flow and accounts for operating expenses, investment earnings, and incentive payments.

$$\text{Total Project Pre-tax Cash Flow in Year Zero} = \text{Issuance of Equity}$$

Where *Issuance of Equity* is the equity investment in the project described above.

$$\text{Total Project Pre-tax Cash Flow in Year } n>0 = \text{Total Cash Flows from Operating Activities} + \text{Total Cash Flows from Investing Activities} + \text{Total Incentives}$$

## Total Project Returns

The total project returns rows of the cash flow table show pre- and after-tax cash flows and returns from the project perspective. Returns from each partner's perspective appear under the Partners Returns heading and are described below.

### Project pre-tax returns

**Total project pre-tax returns**

The total annual pre-tax cash flow is the cash flow and accounts for operating expenses, investment earnings, and incentive payments.

$$\text{Pre-tax Cash Flow in Year Zero} = \text{Issuance of Equity}$$

Where *Issuance of Equity* is the equity investment in the project described above.

$$\text{Pre-tax Cash Flow in Year } n > 0 = \text{Total Cash Flows from Operating Activities} + \text{Total Cash Flows from Investing Activities} + \text{Total Incentives}$$

**Project pre-tax cumulative IRR**

SAM calculates the cumulative IRR for each year N of the cash flow. The cumulative IRR in a given Year N is the discount rate that results in a value of zero for the present value of the discounted pre-tax cash flows up to Year N:

$$NPV = \sum_{n=0}^N \frac{C_{PreTax,n}}{(1 + IRR)^n} = 0$$

Where  $C_{PreTax,n}$  is the pre-tax cash flow described above.

**Project pre-tax cumulative NPV**

The cumulative net present value in a given Year N is the sum of the present values of the pre-tax cash flows up to Year N:

$$NPV = \sum_{n=0}^N \frac{C_{PreTax,n}}{(1 + d_{nominal})^n}$$

Where  $C_{PreTax,n}$  is the pre-tax cash flow described above,  $d_{nominal}$  is the nominal discount rate from the [Financial Parameters](#) page.

**Project after-tax returns****Cash**

The pre-tax cash flow, described above.

**Total project after-tax returns**

The total annual after-tax cash flow is the sum of the pre-tax cash flow and tax credits less income tax payments:

$$\text{After-tax Cash Flow in Year Zero} = \text{Pre-tax Cash Flow in Year Zero}$$

$$\text{After-tax Cash Flow in Year One} = \text{Pre-tax Cash Flow in Year One} + \text{Total ITC} + \text{Total PTC} + \text{Project Tax Benefit}$$

$$\text{After-tax Cash Flow in Year } n > 1 = \text{Pre-tax Cash Flow in Year } n + \text{Total PTC} + \text{Project Tax Benefit}$$

**Project after-tax cumulative IRR**

SAM calculates the cumulative IRR for each year N of the cash flow. The cumulative IRR in a given Year N is the discount rate that results in a value of zero for the present value of the discounted pre-tax cash flows up to Year N:

$$NPV = \sum_{n=0}^N \frac{C_n}{(1 + IRR)^n} = 0$$

Where  $C_{AfterTax,n}$  is the after-tax cash flow described above.

### Project after-tax cumulative NPV

The cumulative net present value in a given Year N is the sum of the present values of the pre-tax cash flows up to Year N:

$$NPV = \sum_{n=0}^N \frac{C_{AfterTax,n}}{(1 + d_{nominal})^n}$$

Where  $C_{AfterTax,n}$  is the after-tax cash flow described above, and  $d_{nominal}$  is the nominal discount rate from the [Financial Parameters](#) page.

## Project LCOE

SAM reports quantities used in the LCOE calculation in the cash flow table for reference. For a description of the LCOE see [Levelized Cost of Energy \(LCOE\)](#).

### Project PPA revenue

The total PPA revenue is the project's annual revenue from electricity sales, not accounting for salvage value:

$$Project\ PPA\ Revenue = Net\ Energy\ (kWh) \times PPA\ Price\ (cents/kWh) \div 100\ (cents/\$)$$

### Net Energy (kWh)

The total amount of electricity generated by the system in AC kilowatt-hours for each year. See description above

### NPV of PPA revenue

The present value of the annual PPA revenue streams over the analysis period used as the numerator of the LCOE equation:

$$NPV(\text{Revenue}) = \sum_{n=0}^N \frac{R_{PPA,n}}{(1 + d_{nominal})^n}$$

Where  $R_{PPA,n}$  is the revenue from electricity sales-tax cash flow described above, and  $d_{nominal}$  is the nominal discount rate from the [Financial Parameters](#) page.

### NPV of net annual energy (nominal)

The LCOE calculation requires a discounted energy term in the denominator. The value discounted using the nominal discount rate is for the nominal LCOE equation.

$$NPV(\text{Energy Nominal}) = \sum_{n=0}^N \frac{Q_n}{(1 + d_{nominal})^n}$$

Where  $Q_n$  is the annual energy value described above, and  $d_{nominal}$  is the nominal discount rate from the [Financial Parameters](#) page.

**Project Nominal LCOE**

$$\text{Project Nominal LCOE} = \text{NPV(Revenue)} / \text{NPV(Energy Nominal)}$$

**NPV of net annual energy (real)**

The LCOE calculation requires a discounted energy term in the denominator. The value discounted using the real discount rate is for the real LCOE equation.

$$\text{NPV(Energy Real)} = \sum_{n=0}^N \frac{Q_n}{(1 + d_{real})^n}$$

Where  $Q_n$  is the annual energy value described above, and  $d_{real}$  is the nominal discount rate from the [Financial Parameters](#) page.

**Project Real LCOE**

$$\text{Project Real LCOE} = \text{NPV(Revenue)} / \text{NPV(Energy Real)}$$

**Partners Returns**

The partners returns are the IRR, NPV, and taxes from each project partner's perspective.

**Tax Investor**

The tax investor cash flows represent the tax investor share of project cash flows.

**Tax Investor Pre-Tax Returns****Total tax investor pre-tax returns**

In Year Zero, the tax investor pre-tax cash flow is the portion of equity capital allocated to the tax investor:

$$\text{Tax Investor Pre-Tax Cashflow in Year Zero} = \text{Tax Investor Share of Equity Contribution (\%)} \times \text{Issuance of Equity (\$)}$$

Where *Tax Investor Share of Equity Contribution* is from the [Financial Parameters](#) page.

For years before the flip target is reached:

$$\text{Tax Investor Pre-Tax Cashflow in Year } n > 1 = \text{Tax Investor Pre-flip Share of Project Cash (\%)} \times \text{Total Project Pre-tax Cash Flow (\$)}$$

For years after the flip target is reached:

$$\text{Tax Investor Pre-Tax Cashflow in Year } n > 1 = \text{Tax Investor Post-flip Share of Project Cash (\%)} \times \text{Total Project Pre-tax Cash Flow (\$)}$$

Where the pre- and post-flip share of project cash percentages are from the [Financial Parameters](#) page.

**Tax investor cumulative IRR**

Cumulative pre-tax IRR from the tax investor perspective for each year N of the cash flow. The cumulative IRR in a given Year N is the discount rate that results in a value of zero for the present value of the discounted pre-tax cash flows up to Year N:

$$\text{NPV} = \sum_{n=0}^N \frac{C_{PreTax,n}}{(1 + \text{IRR})^n} = 0$$

Where  $C_{PreTax,n}$  is the tax investor pre-tax cash flow described above.

For years when there is no mathematical solution, SAM reports a value of zero.

### Tax investor cumulative NPV

Cumulative pre-tax net present value from the tax investor perspective in a given Year N is the sum of the present values of the pre-tax cash flows up to Year N:

$$NPV = \sum_{n=0}^N \frac{C_{PreTax,n}}{(1 + d_{nominal})^n}$$

Where  $C_{PreTax,n}$  is the tax investor pre-tax cash flow described above,  $d_{nominal}$  is the nominal discount rate from the [Financial Parameters](#) page.

## Tax Investor After-Tax Returns

### Tax investor cash (total pre-tax returns)

The tax investor pre-tax cash flow, described above.

### ITC

The tax investor's share of the ITC amount applies to the tax investor's Year One cash flow:

$$\text{Investment Tax Credit in Year One} = \text{Tax Investor Share of Equity Contribution (\%)} \times (\text{Federal ITC (\$)} + \text{State ITC (\$)})$$

Where *Tax Investor Share of Equity Contribution* is from the [Financial Parameters](#) page, and *Federal ITC* and *State ITC* are described below.

### PTC

The tax investor's share of the PTC applies in Years One and later of the tax investor's cash flow.

For years before the flip target is reached:

$$\text{Production Tax Credit in Year } n = \text{Tax Investor Pre-flip Share of Project Cash (\%)} \times (\text{Federal PTC (\$)} + \text{State PTC (\$)})$$

For years after the flip target is reached:

$$\text{Production Tax Credit in Year } n = \text{Tax Investor Post-flip Share of Project Cash (\%)} \times (\text{Federal PTC (\$)} + \text{State PTC (\$)})$$

Where the pre- and post-flip share of project cash values are from the [Financial Parameters](#) page, and *Federal PTC* and *State PTC* are described below.

### Tax investor share of project tax

The tax investor's share of the project's tax payment or refund. A positive value indicates a tax refund, and a negative value indicates a tax payment.

For years before the flip target is reached:

$$\text{Tax Investor Share of Project Tax in Year } n = \text{Tax Investor Pre-flip Share of Project Cash (\%)} \times \text{Project Tax Benefit/(Liability) (\$)}$$

For years after the flip target is reached:

$$\text{Tax Investor Share of Project Tax in Year } n = \text{Tax Investor Post-flip Share of Project Cash (\%)} \times \text{Project Tax Benefit/(Liability) (\$)}$$

Where the pre- and post-flip share of project cash values are from the [Financial Parameters](#) page, and

Project Tax Benefit/(Liability) is the tax amount owed.

### Total tax investor after-tax returns

The tax investor's total after-tax cash flow.

$$\text{Total} = \text{Cash} + \text{Investment Tax Credit} + \text{Production Tax Credit} + \text{Share of Project Tax Benefit/} \\ \text{(Liability)}$$

### Tax investor cumulative IRR

Cumulative after-tax IRR from the tax investor perspective for each year N of the cash flow. The cumulative IRR in a given Year N is the discount rate that results in a value of zero for the present value of the discounted pre-tax cash flows up to Year N:

$$NPV = \sum_{n=0}^N \frac{C_n}{(1 + IRR)^n} = 0$$

Where  $C_{PreTax,n}$  is the tax investor after-tax cash flow described above.

For years when there is no mathematical solution, SAM reports a value of zero.

### Tax investor cumulative NPV

Cumulative after-tax net present value from the tax investor perspective in a given Year N is the sum of the present values of the pre-tax cash flows up to Year N:

$$NPV = \sum_{n=0}^N \frac{C_{AfterTax,n}}{(1 + d_{nominal})^n}$$

Where  $C_{PreTax,n}$  is the tax investor after-tax cash flow described above,  $d_{nominal}$  is the nominal discount rate from the [Financial Parameters](#) page.

### Tax investor maximum IRR

The greater of the Year One Cumulative IRR and the Year n Cumulative IRR.

## Developer

The Developer cash flows represent the developer share of project cash flows.

### Developer Pre-Tax Returns

#### Pre-tax development fee

A fee received by the developer.

$$\text{Pre-tax Developer Development Fee in Year Zero} = \text{Development Fee}$$

Where *Development Fee* is from the [Financial Parameters](#) page.

#### Total developer pre-tax returns

The pre-tax cash flow from the developer's perspective.

$$\text{Developer Pre-tax Cash Flow in Year Zero} = \text{Equity Investment in Year Zero} + \text{Pre-tax Developer} \\ \text{Development Fee}$$

$$\text{Developer Pre-tax Cash Flow in Year } n > 0 = \text{Total Project After-tax Cash Flow} - \text{Tax Investor Pre-tax} \\ \text{Cash Flow}$$



**Developer pre-tax cumulative IRR**

Cumulative pre-tax IRR from the developer perspective for each year N of the cash flow. The cumulative IRR in a given Year N is the discount rate that results in a value of zero for the present value of the discounted pre-tax cash flows up to Year N:

$$NPV = \sum_{n=0}^N \frac{C_{PreTax,n}}{(1 + IRR)^n} = 0$$

Where  $C_{PreTax,n}$  is the tax investor after-tax cash flow described above.

For years when there is no mathematical solution, SAM reports a value of zero.

**Developer pre-tax cumulative NPV**

Cumulative pre-tax net present value from the developer perspective in a given Year N is the sum of the present values of the pre-tax cash flows up to Year N:

$$NPV = \sum_{n=0}^N \frac{C_{PreTax,n}}{(1 + d_{nominal})^n}$$

Where  $C_{PreTax,n}$  is the tax investor after-tax cash flow described above,  $d_{nominal}$  is the nominal discount rate from the [Financial Parameters](#) page.

**Developer pre-tax IRR**

The cumulative tax investor pre-tax IRR in the flip year defined on the [Financial Parameters](#) page.

For years when there is no mathematical solution, SAM reports a value of zero.

**Developer pre-tax NPV**

The cumulative tax investor pre-tax NPV in the flip year defined on the [Financial Parameters](#) page.

**Developer After-Tax Returns****Equity Investment**

The developer's share of the project equity capital.

$$\text{Equity Investment in Year Zero} = \text{Total Project Equity Investment in Year Zero} - \text{Tax Investor Equity Investment in Year Zero}$$

**Development Fee**

A fee received by the developer.

$$\text{Development Fee in Year Zero} = \text{Development Fee}$$

Where *Development Fee* is from the [Financial Parameters](#) page.

**Cash**

The pre-tax cash flow from the developer perspective.

$$\text{Cash in Year Zero} = \text{Equity Investment} + \text{Development Fee}$$

$$\text{Cash in Year } n > 0 = \text{Developer Pre-tax Cash Flow}$$

**ITC**

The developer's share of the ITC amount applies to the tax developer's Year One cash flow:

$$\text{Investment Tax Credit in Year One} = \text{Developer Share of Equity Contribution (\%)} \times (\text{Federal ITC (\$)})$$

+ State ITC (\$) )

Where *Developer Share of Equity Contribution* is from the [Financial Parameters](#) page, and *Federal ITC* and *State ITC* are described below.

### PTC

The developer's share of the PTC applies in Years One and later of the developer's cash flow.

For years before the flip target is reached:

$$\text{Production Tax Credit in Year } n = \text{Developer Pre-flip Share of Project Cash (\%)} \times (\text{Federal PTC (\$)} + \text{State PTC (\$)})$$

For years after the flip target is reached:

$$\text{Production Tax Credit in Year } n = \text{Developer Post-flip Share of Project Cash (\%)} \times (\text{Federal PTC (\$)} + \text{State PTC (\$)})$$

Where the pre- and post-flip share of project cash values are from the [Financial Parameters](#) page, and *Federal PTC* and *State PTC* are described below.

### Developer share of project tax

The developer's share of the project's tax payment or refund. A positive value indicates a tax refund, and a negative value indicates a tax payment.

For years before the flip target is reached:

$$\text{Developer Share of Project Tax in Year } n = \text{Developer Pre-flip Share of Project Cash (\%)} \times \text{Project Tax Benefit/(Liability) (\$)}$$

For years after the flip target is reached:

$$\text{Developer Share of Project Tax in Year } n = \text{Developer Post-flip Share of Project Cash (\%)} \times \text{Project Tax Benefit/(Liability) (\$)}$$

Where the pre- and post-flip share of project cash values are from the [Financial Parameters](#) page

### Total developer after-tax returns

The developer's total after-tax cash flow.

$$\text{Total Developer After-tax Returns} = \text{Cash} + \text{Investment Tax Credit} + \text{Production Tax Credit} + \text{Share of Project Tax Benefit/(Liability)}$$

### Developer after-tax cumulative IRR

Cumulative after-tax IRR from the developer perspective for each year  $n$  of the cash flow. The cumulative IRR in a given Year  $n$  is the discount rate that results in a value of zero for the present value of the discounted pre-tax cash flows up to Year  $N$ :

$$NPV = \sum_{n=0}^N \frac{C_n}{(1 + IRR)^n} = 0$$

Where  $C_{PreTax,n}$  is the developer after-tax cash flow described above.

For years when there is no mathematical solution, SAM reports a value of zero.

### Developer after-tax cumulative NPV

Cumulative after-tax net present value from the developer perspective in a given Year  $n$  is the sum of the present values of the pre-tax cash flows up to Year  $N$ :

$$NPV = \sum_{n=0}^N \frac{C_{AfterTax,n}}{(1 + d_{nominal})^n}$$

Where  $C_{PreTax,n}$  is the developer after-tax cash flow described above,  $d_{nominal}$  is the nominal discount rate from the [Financial Parameters](#) page.

### Developer after-tax IRR

The cumulative developer pre-tax IRR in the flip year defined on the [Financial Parameters](#) page.

For years when there is no mathematical solution, SAM reports a value of zero.

### Developer after-tax NPV

The cumulative developer pre-tax NPV in the flip year defined on the [Financial Parameters](#) page.

## Incentives

[Incentives](#) may consist of either cash incentives (IBI, CBI, PBI) or tax credits (ITC, PTC), and may either calculated based on project investment costs (IBI, CBI, ITC), or the project's energy production (PBI, PTC).

The values in the incentives rows of the cash flow table are shown for reference. Their impact on project cash flows are shown in the project cash flows described above:

- PBI income appears under **Cash Flows from Operating Activities**.
- IBI and CBI income appear under **Cash Flows from Investing Activities**.
- ITC and PTC amounts appear under **Partners Returns, Tax Investor, After-Tax**.

The incentive cash flow rows show the value of cash incentives and tax credits, which are used to calculate cash flows described above.

### IBI (Investment Based Incentives)

Each IBI (federal, state, utility, other) applies in Year Zero of the project cash flow.

Because you can specify each IBI on the [Incentives](#) page as either an amount or a percentage, SAM calculates the value of each IBI as the sum of two values:

$$IBI \text{ as Amount} = \text{Amount}$$

$$IBI \text{ as Percentage} = \text{Total Installed Cost (\$)} \times \text{Percentage (\%)}, \text{ up to Maximum}$$

$$IBI \text{ in Year 0} = IBI \text{ as Amount} + IBI \text{ as Percentage}$$

Where *Amount*, *Percentage* and *Maximum* are the values that you specify on the [Incentives](#) page, and *Total Installed Cost* is from the [System Costs](#) page.

*Total IBI* is the sum of the four IBI values (federal, state, utility, other).

**Note.** The IBI amount reduces the after tax cost flow in Year Zero, and the debt balance in Year One. This is because SAM assumes that debt payments begin in Year One, when the project is generating or saving electricity.

### CBI (Capacity Based Incentives)

Each CBI (federal, state, utility, other) applies in Year Zero of the project cash flow:

$$CBI \text{ in Year 0} = \text{System Capacity (W)} \times \text{Amount (\$/W)}, \text{ up to Maximum}$$

Where System Capacity is the rated capacity of the system, and *Amount* and *Maximum* are the values you specify on the [Incentives](#) page.

*Total CBI* is the sum of the four CBI values (federal, state, utility, other).

The system nameplate capacity depends on technology being modeled. SAM converts the capacity value to the appropriate units (MW, kW, or W) before using it in calculations. For the photovoltaic models, the capacity is a DC power rating, and for the others it is an AC power rating. For the Solar Water Heating Model, the capacity is a thermal rating, while for the others it is an electric rating.

**Table 18. Nameplate system capacity values for each technology.**

Performance Model	System Capacity	Input Page
Detailed photovoltaic (DC)	Total Array Power (Wdc)	<a href="#">Array</a>
PVWatts (DC)	DC Rating (kWdc)	<a href="#">PVWatts Solar Array</a>
High concentration photovoltaic (DC)	System Nameplate Capacity	<a href="#">Array</a>
CSP Parabolic Trough - Physical (AC)	Estimated Net Output at Design (Nameplate) (MWe)	<a href="#">Power Cycle</a>
CSP Parabolic Trough - Empirical (AC)	Estimated Net Output at Design (MWe)	<a href="#">Power Block</a>
CSP Molten Salt Power Tower (AC)	Estimated Net Output at Design (Nameplate) (MWe)	<a href="#">Power Cycle</a>
CSP Generic Solar (AC)	Estimated Net Output at Design (Nameplate) (MWe)	<a href="#">Power Block</a>
CSP Linear Fresnel (AC)	Net nameplate capacity (MWe)	<a href="#">Power Cycle</a>
Generic System (AC)	Nameplate Capacity (kWe)	<a href="#">Power Plant</a>
Geothermal	Net Plant Output (MWe)	<a href="#">Plant and Equipment</a>
Water Heating Model (Thermal)	Nameplate Capacity (kWt)	<a href="#">SWH System</a>
Wind Power (AC)	System Nameplate Capacity (kWe)	<a href="#">Wind Farm</a>
Biopower (AC)	Nameplate Capacity, Gross (kWe)	<a href="#">Plant Specs</a>

#### **PBI (Performance Based Incentive)**

Each PBI (federal, state, utility, other) applies in Years One and later of the project cash flow, up to the number of years you specify:

$$PBI \text{ in Year } n = \text{Amount } (\$/kWh) \times \text{Energy in Year } n \text{ (kWh)} \times (1 + \text{Escalation})^{(n-1)}, \text{ up to Term}$$

Where *Amount*, *Term*, and *Escalation* are the values you specify on the [Incentives](#) page, and *Energy* is the value displayed in Energy row of the cash flow table (described above).

**Note.** If you use an annual schedule to specify year-by-year PBI amounts, SAM ignores the escalation rate.

*Total PBI* is the sum of the four PBI amounts (federal, state, utility, other).

**Important Note!** If you specify a PBI amount on the Cash Incentives page, be sure to also specify the incentive term. If you specify a term of zero, the incentive will not appear in the cash flow table.

### PTC (Production Tax Credit)

The state and federal PTC each apply in Year One and later of the project cash flow, up to the number of years you specify:

$$PTC \text{ in Year } n = \text{Amount } (\$/kWh) \times (1 + \text{Escalation})^{(n-1)} \times \text{Energy in Year } n \text{ (kWh)}$$

Where *Amount*, *Term*, and *Escalation* are the values you specify on the [Incentives](#) page, and *Energy* is the value displayed in the Energy row of the cash flow table (described above).

SAM rounds the product  $\text{Amount } (\$/kWh) \times (1 + \text{Escalation})^{(n-1)}$  to the nearest multiple of 0.1 cent as described in Notice 2010-37 of [IRS Bulletin 2010-18](#).

**Note.** If you specify year-by-year PTC rates on the Incentives page using an Annual Schedule instead of a single value, SAM ignores the PTC escalation rate.

### ITC (Investment Tax Credit)

The state and federal ITC each apply only in Year One of the project cash flow. For ITCs that you specify as a fixed amount:

$$ITC \text{ in Year One} = \text{Amount}$$

Where *Amount* is the value you specify in the [Incentives](#) page.

For ITCs that you specify as a percentage of total installed costs:

$$ITC \text{ in Year One} = ( \text{Total Installed Cost } (\$) - \text{ITC Basis Reduction } (\$) ) \times \text{Percentage } (\%), \text{ up to Maximum}$$

Where *Total Installed Cost* is from the [System Costs](#) page, and *Percentage* and *Maximum* are the values you specify on the [Incentives](#) page.

*ITC Basis Reduction* applies only to the Commercial and PPA financial models, and depends on whether the project includes any investment-based incentives (IBI) or capacity-based incentives (CBI) specified on the [Incentives](#) page with checked boxes under **Reduces Depreciation and ITC Bases**. For each IBI or CBI with a check mark, SAM subtracts the incentive amount from the total installed cost to calculate the ITC.

$$ITC \text{ Basis Reduction} = IBI + CBI$$

Where *IBI* and *CBI* are the incentives that you have specified reduce the ITC basis on the [Incentives](#) page.

## Debt

The debt amounts depend on the following inputs from the [Financial Parameters](#) page:

- Debt Rate
- DSCR

## Debt Repayment

The debt repayment rows show the size of annual debt payments.

## Debt Sizing (Constant Payments)

When you specify the debt percent as an input on the Financial Parameters page, SAM assumes constant total annual debt payments so that the annual debt service coverage ratio (DSCR) varies from year to year. In this mode, SAM reports the minimum DSCR in the Metrics table.

### Debt Sizing (Constant DSCR)

When you specify the DSCR as an input on the Financial Parameters page, SAM assumes a constant annual DSCR and sculpted debt, where annual debt payments vary to match cash available for debt services. In this mode, SAM reports the debt percent in the Metrics table.

### Reserve Accounts

Reserve accounts include debt service, working capital reserve, and major equipment replacement reserves. The reserve account amounts depend on the following inputs from the Financial Parameters page:

- Inflation Rate
- Debt Service Reserve Account (months P&I)
- Working Capital Reserve Months of Operating Costs
- Major Equipment Replacement Reserve Account [1-3] Frequency (years)
- Major Equipment Replacement [1-3] (Year 1 \$)

#### Lease Payment Reserve (Sale Leaseback only)

$$\text{Lease Payment Reserve} = \text{Tax Investor (Lessor) Required Lease Payment Reserve (months)} \div 12 \times \text{Total Developer Pre-tax Cash Flow from Operating Activities in Year } n+1$$

#### Debt Service Reserve

The debt service reserve applies in Year Zero and later:

$$\text{Debt Service Reserve} = \text{Debt Service Reserve Account (months P\&I)} \div 12 \times \text{Total P\&I in Year } n+1$$

Where *Debt Service Reserve Account (months P&I)* is from the Financial Parameters page, and *Total P&I in Year n+1* is described under Debt above.

#### Working Capital Reserve

Working capital reserve applies in Year Zero and later:

$$\text{Working Capital Reserve} = \text{Months of Operating Costs} \times \text{Operating Expenses in Year } n+1$$

Where *Months of Operating Costs* is from the Financial Parameters page, and *Operating Expenses in Year n+1* is described above.

#### Major Equipment Replacement Reserves

You can specify up to three major equipment reserve accounts on the Financial Parameters page. For each account, the amount applies in Year One and later of the cash flow:

$$\text{Major Equipment Reserve in Year } n = \text{Major Equipment Reserve in Year } n-1 + \text{Funding} + \text{Release of Funds}$$

Where Major Equipment Reserve in Year Zero = 0, and:

$$\text{Funding} = \text{Release of Funds in Year of Next Replacement} \div \text{Replacement Frequency}$$

$$\text{Release of Funds in Year of Next Replacement} = - \text{Replacement Cost in Year One } \$ \times (1 + \text{Inflation Rate})^{(n-1)}$$

Where *Replacement Frequency*, *Replacement Cost in Year One \$*, and *Inflation Rate* are from the Financial Parameters page

## Depreciation and ITC Tables

The federal and state Depreciation and ITC tables show the depreciable basis calculation for each of the up to seven depreciation classes for federal and state tax purposes:

- The total depreciable amount includes the total installed cost, development fee, equity closing cost, debt service reserve, working capital reserve, and for the Sale Leaseback financial model, the lease payment reserve.
- The depreciation class allocations on the [Financial Parameters](#) page determine how the depreciable basis is allocated to the different depreciation classes (MACRS 5-yr, Straight Line, etc.).
- For each state and federal IBI and CBI with **Reduces Depreciation and ITC Bases** checked on the [Incentives](#) page, the full incentive amount reduces the depreciable basis.
- For each state and federal ITC with **Reduces Depreciation Basis** checked on the [Incentives](#) page, 50% of the tax credit amount reduces the depreciable basis.
- For each depreciation class with a checked box under **Bonus Depreciation** on the Financial Parameters page, the depreciable basis is the product of the bonus depreciation percentage and the adjusted depreciable basis. (The adjusted depreciable basis is the total depreciable after incentives and tax credit adjustments.)
- For state and federal taxes, depreciation for major equipment replacement reserves uses the class specified on the Financial Parameters page.

The depreciation amounts depend on the total installed cost from the [System Costs](#) page, and the following inputs from other pages.

From the Financial Parameters page:

- Development Fee
- Debt Closing Costs
- Debt Closing Fee
- Equity Closing Cost
- Construction Financing
- Other Financing Cost

From the [Incentives](#) page:

- State ITC as Percentage
- State ITC Maximum
- State ITC as Amount
- Federal ITC as Percentage
- Federal ITC Maximum
- Federal ITC as Amount
- Status of **Reduces Depreciation Basis** check boxes
- The amounts and percentages of any incentive with **Reduces Depreciation and ITC Bases** checked

From the [Depreciation](#) page:

- Allocations for each depreciation class
- Bonus depreciation amounts and applicable depreciation classes
- ITC qualification status of depreciation classes

The depreciation amounts also depend on the following cash flow values:

- Debt service reserve
- Working capital reserve
- IBI (only for incentives shown to reduce depreciation basis on Incentives page)
- CBI (only for incentives shown to reduce depreciation basis on Incentives page)
- Debt funding
- For state depreciation, the federal ITC basis disallowance amounts for each depreciation class
- For federal depreciation, the state ITC basis disallowance amounts for each depreciation class

### Gross Depreciable Basis with IBI and CBI Reductions Before ITC Reductions

For each depreciable class, the depreciable basis before reduction by the ITC is the gross depreciable basis less IBI and CBI amounts for incentives on the Cash Incentives page with **Reduces Depreciation and ITC Bases** checked.

**Note.** The IBI and CBI reduce the depreciation basis for state taxes only when **State** under **Reduces Depreciation and ITC Bases** is checked. Similarly, the IBI and CBI reduce the depreciation basis for federal taxes only when **Federal** under **Reduces Depreciation and ITC Bases**.

#### % of Total Depreciable Basis

The normalized allocation for each depreciation class allocation:

$$\% \text{ of Total Depreciable Basis} = \text{Allocation} \div \text{Sum of Allocations}$$

Where *Allocation* is the percentage for the given depreciable class, and *Sum of Allocations* is the sum of all allocations from the Financial Parameters page.

#### Gross Amount Allocated

The gross depreciable basis before reductions for each depreciation class:

$$\text{Gross Amount Allocated} = \% \text{ of Total Depreciable Basis} \times \text{Total Depreciable Amount}$$

Where % of Total Depreciable Basis is described above, and

$$\text{Total Depreciable Amount} = \text{Total Installed Cost} + \text{Development Fee} + \text{Equity Closing Cost} + \text{Debt Closing Costs} + \text{Debt Closing Fee} \times \text{Funding} + \text{Debt Service Reserve} + \text{Working Capital Reserve} + \text{Lease Payment Reserve}$$

Where *Total Installed Cost* is from the [System Costs](#) page; *Development Fee*, *Equity Closing Cost*, *Debt Closing Costs*, and *Debt Closing Fee* are from the [Financial Parameters](#) page; and *Debt Service Reserve*, *Working Capital Reserve* and *Lease Payment Reserve* (Sale Leaseback financial model only) are other values in the cash flow described above

#### Reduction: IBI

The reduction in depreciation basis from IBI payments:

$$\text{Reduction IBI} = \text{Total IBI that Reduce Depreciation} \times \% \text{ of Total Depreciable Basis}$$

Where *Total IBI that Reduce Depreciation* is the sum of IBI values in the cash flow for incentives with **Reduces Depreciation and ITC Bases** checked on the [Incentives](#) page. For the state depreciation table, **State** must be checked for the incentive to reduce the state depreciation basis. For the federal depreciation table, **Federal** must be checked. % of Total Depreciable Basis is the allocation for the depreciation class described above.

#### Reduction: CBI

The reduction in depreciation basis from CBI payments:



$$\text{Reduction CBI} = \text{Total CBI that Reduce Depreciation} \times \% \text{ of Total Depreciable Basis}$$

Where *Total CBI that Reduce Depreciation* is the sum of CBI values in the cash flow for incentives with **Reduces Depreciation and ITC Bases** checked on the [Incentives](#) page. For the state depreciation table, **State** must be checked for the incentive to reduce the state depreciation basis. For the federal depreciation table, **Federal** must be checked. *% of Total Depreciable Basis* is the allocation for the depreciation class described above.

### Depreciable Basis Prior to ITC

The depreciable basis reduced by CBI and IBI amounts:

$$\text{Depreciable Basis Prior to ITC} = \text{Gross Amount Allocated} - \text{Reduction: IBI} - \text{Reduction: CBI}$$

### ITC Reduction

For each ITC on the [Incentives](#) page with **Reduces Depreciation Basis** checked, 50% of the ITC amount can be included in the depreciable basis for each depreciable class with **ITC Qualification** checked on the [Depreciation](#) page. SAM calculates the ITC reduction amount for ITCs that you specify on the Incentives page a percentage of the total installed costs with a maximum amount, and ITCs that you specify as a fixed amount.

**Note.** The ITC reduces the depreciation basis for state taxes only when **State** under **Reduces Depreciation Basis** is checked on the [Incentives](#) page, and when **State** is checked under **ITC Qualification** for the depreciation class on the [Depreciation](#) page. Similarly, the ITC reduces the depreciation basis for federal taxes only when **Federal** is checked under **Reduces Depreciation Basis** and under **ITC Qualification** for the depreciation class.

For each ITC specified as a percentage and maximum on the Incentives page, the *ITC Basis Disallowance* is the amount that may be available for depreciation basis reduction. (The ITC Reduction amounts are the amounts actually available.):

### ITC Qualifying Costs

For depreciation classes with **ITC Qualification** checked on the [Depreciation](#) page:

$$\text{ITC Qualifying Costs} = \text{Depreciable Basis Prior to ITC}$$

### % of ITC Qualifying Costs

For each depreciable class:

$$\% \text{ of ITC Qualifying Costs} = \text{ITC Qualifying Costs} \div \text{Total Depreciable Basis Prior to ITC}$$

Where *Total Depreciable Basis Prior to ITC* is the sum of *Depreciable Basis Prior to ITC* for all depreciable classes.

### ITC Amount

$$\text{ITC Amount} = \% \text{ of ITC Qualifying Costs} \times \text{ITC Qualifying Costs}$$

### ITC Basis Disallowance

The ITC depreciation basis disallowance is 50% of the ITC amount:

$$\text{ITC Basis Disallowance} = \text{ITC Amount} \times 0.5$$

For each ITC specified as a fixed amount on the Incentives page, the ITC Basis Disallowance is the amount that may be available for depreciation basis reduction. (The ITC Reduction amounts are the amounts actually available.):

### ITC Amount

For each depreciable class, the Total ITC Amount is the amount that may be available for depreciation reduction:

$$ITC\ Amount = Total\ ITC\ Amount \times \%\ of\ ITC\ Qualifying\ Costs$$

Where, for the state depreciation table, *Total ITC Amount* is the state ITC amount from the [Incentives](#) page. For the federal depreciation table, *Total ITC Amount* is the federal ITC amount from the [Incentives](#) page.

### ITC Basis Disallowance

The ITC depreciation basis disallowance is 50% of the ITC amount:

$$ITC\ Basis\ Disallowance = ITC\ Amount \times 0.5$$

The depreciable basis after ITC reduction is the sum of the total ITC basis disallowance values for the ITCs with **Reduces Depreciation Basis** checked on the Incentives pages.

### ITC Reduction: State

$$ITC\ Reduction: State = ITC\ Basis\ Disallowance\ (ITC\ as\ \%) + ITC\ Basis\ Disallowance\ (ITC\ as\ Fixed\ Amount)$$

Where the ITC basis disallowance values are from the state depreciation table for the ITCs that reduce depreciation basis.

### ITC Reduction: Federal

$$ITC\ Reduction: Federal = ITC\ Basis\ Disallowance\ (ITC\ as\ \%) + ITC\ Basis\ Disallowance\ (ITC\ as\ Fixed\ Amount)$$

Where the ITC basis disallowance values are from the federal depreciation table for the ITCs that reduce depreciation basis.

### Depreciable Basis after ITC Reduction

$$Depreciable\ Basis\ after\ ITC\ Reduction = Depreciable\ Basis\ Prior\ to\ ITC - ITC\ Reduction:State - ITC\ Reduction:Federal$$

## Bonus Depreciation

For each depreciation class that qualifies for bonus depreciation as indicated by the check boxes under Bonus Depreciation on the [Depreciation](#) page, bonus depreciation percentage applies to the depreciable basis.

**Note.** The bonus depreciation percentage applies to the depreciation basis for state taxes only when **State** under **Bonus Depreciation** is checked. Similarly, the bonus depreciation percentage applies for federal taxes only when **Federal** under **Reduces Depreciation Basis** is checked.

### First Year Bonus Depreciation

For each depreciation class with **Bonus Depreciation** checked on the Depreciation page:

$$First\ Year\ Bonus\ Depreciation = Depreciable\ Basis\ after\ ITC\ Reduction \times Bonus\ Depreciation\ Percentage$$

Where Bonus Depreciation Percentage is from the Depreciation page: The state bonus percentage applies to the state depreciation table, and the federal percentage applies to the federal depreciation table.

## Depreciable Basis

The depreciable basis after IBI, CBI, ITC and bonus depreciation reduction is the basis to which the depreciation percentages defined by the depreciation class apply.

$$\text{Depreciable Basis after Bonus Reduction} = \text{Depreciable Basis after ITC Reduction} - \text{First Year Bonus Depreciation}$$

The following table shows the depreciation percentage by year for each depreciation class. For each depreciation class, the percentage is applied to the depreciable basis amount for the given year in the cash flow:

Years 1-10	1	2	3	4	5	6	7	8	9	10
5-yr MACRS	20.0	32.0	19.2	11.5	11.5	5.8				
15-yr MACRS	5.0	9.5	8.6	7.7	6.9	6.2	5.9	5.9	5.9	5.9
5-yr SL	10.0	20.0	20.0	20.0	20.0	10.0				
15-yr SL	3.3	6.7	6.7	6.7	6.7	6.7	6.7	6.7	6.7	6.7
20-yr SL	2.5	5.0	5.0	5.0	5.0	5.0	5.0	5.0	5.0	5.0
39-yr SL	1.3	2.6	2.6	2.6	2.6	2.6	2.6	2.6	2.6	2.6
Years 11-20	11	12	13	14	15	16	17	18	19	20
15-yr MACRS	5.9	5.9	5.9	5.9	5.9	3.0				
15-yr SL	6.7	6.7	6.7	6.7	6.7	3.3				
20-yr SL	5.0	5.0	5.0	5.0	5.0	5.0	5.0	5.0	5.0	5.0
39-yr SL	2.6	2.6	2.6	2.6	2.6	2.6	2.6	2.6	2.6	2.6
Years 21-30	21	22	23	24	25	26	27	28	29	30
20-yr SL	2.5									
39-yr SL	2.6	2.6	2.6	2.6	2.6	2.6	2.6	2.6	2.6	2.6
Years 31-40	31	32	33	34	35	36	37	38	39	40
39-yr SL	2.6	2.6	2.6	2.6	2.6	2.6	2.6	2.6	2.6	1.3

## 34.4 Leveraged Partnership Flip

This topic describes the [cash flow](#) table generated by the financial model for the Leveraged Partnership Flip financial model. See [Financial Models](#) for details.

SAM offers three options for exporting cash flow data:

- **Copy to clipboard** copies the table to your clipboard. You can paste the entire table into a word processing document, spreadsheet, presentation or other software.
- **Save as CSV** saves the table in a comma-delimited text file that you can open in a spreadsheet program or text editor.
- **Send to Excel** (Windows only) creates an Excel workbook that contains the data from the cash flow, but no formulas.

- **Send to Excel with Equations** (Windows only) exports the cash flow data to an existing Excel workbook that contains formulas to illustrate how SAM's internal cash flow calculations work. The workbooks are in the *runtime\spreadsheets* folder of your [SAM installation folder](#).

**Notes.**

SAM makes cash flow calculations internally during the simulation. It does not use Excel to make the calculations. The two **Send to Excel** options are to help you analyze the cash flow data and understand how SAM's internal calculations work.

You can also display cash flow data by building a [data](#) table.

## Production

### Energy Values for Financial Models Except Single Owner

#### Energy, kWh

For systems that generate electricity, the total amount of electricity generated by the system in AC kilowatt-hours for each year.

For solar water heating systems, the total amount of electricity saved by the solar water heating system in AC kilowatt-hours for each year.

### Energy Values for the Single Owner Financial Model

#### Energy to grid, kWh

Total AC electricity delivered to the grid by the power system in each year of the analysis period, including electricity from battery storage if applicable.

This value is the sum of the hourly or subhourly Electricity to grid values.

#### Energy from grid, kWh

Total grid AC electricity consumed by the power system in each year to meet loads for inverter night-time consumption, battery charging, and freeze protection and other parasitic loads for concentrating power systems.

This value is the sum of hourly or subhourly Electricity from grid values.

#### Net energy to grid, kWh

The total net AC electricity delivered to the grid by the power system in each year of the analysis period. For projects with a fixed power price, this is the value used to determine project revenue. For projects with time-of-delivery (TOD) power price multipliers, the revenue is calculated on a time-step basis.

## Energy and Degradation

For Year One of the project cash flow, the energy values are calculated the performance model

$$\text{Energy in Year One} = \text{Sum of Hourly or Sub-hourly Values}$$

Where Sum of Hourly or Sub-hourly Values is the system's total annual electrical output (or energy saved), equal to the sum of the values calculated by the performance model (8,760 values for hourly simulations).

For Years 2 and later:

$$\text{Energy in Year } n > 1 = \text{Energy in Year } n-1 \times (1 - \text{degradation rate})$$

Where Energy in Year n-1 is the previous year's energy value and degradation rate is from the [Lifetime](#) page.

**Note.** If you specified **degradation rate** on the [Lifetime](#) page using the [annual schedule](#) option, SAM applies the value as follows:

$$\text{Energy in Year } n > 1 = \text{Energy in Year } 1 \times (1 - \text{degradation rate} \div 100\%)$$

## Revenue

### PPA price (cents/kWh)

The PPA price in Year One is either the value you specify on the [Financial Parameters](#) page, or the value calculated by SAM to meet the IRR target you specify on the Financial Parameters page. The PPA price in Year One is the PPA price:

$$\text{PPA Price in Year One} = \text{Adjusted PPA Price}$$

For analyses that do not involve time-dependent pricing, *Adjusted PPA Price* is equal to the [PPA Price](#) reported on the [Metrics table](#).

For analyses that do involve time-dependent pricing, for each hour of the year, SAM multiplies the [PPA price](#) shown in the [Metrics table](#) (equivalent to the bid price) by the TOD factor for that hour to calculate a set of hourly energy prices for Year one. The *Adjusted PPA Price* is the average of the 8,760 hourly values.

#### Notes.

When you choose **Specify PPA Price** for **Solution Mode** on the Financial Parameters page, the [PPA Price](#) in the [Metrics table](#) is equal to the price you specify. When you choose **Specify IRR Target**, SAM calculates the PPA price required to meet the IRR target that you specify.

The TOD factors are on the Thermal Energy Storage page for CSP systems (parabolic trough, power tower, linear Fresnel, generic solar system), and on the [Revenue](#) page for photovoltaic and other systems.

To remove time-dependent pricing from your analysis, set the TOD factor for each of the 9 periods to one. Where Adjusted [PPA Price](#) is either the value you specify on the Financial Parameters page, or a value calculated to cover project costs based on the target IRR you specify on the [Financial Parameters](#) page, adjusted by the time-of-delivery (TOD) factors.

In Years Two and later:

$$\text{PPA Price in Year } n > 1 = \text{PPA Price in Year } n-1 \times (1 + \text{PPA Escalation Rate})^{(n-1)}$$

Where *PPA Escalation Rate* is from the [Financial Parameters](#) page.

**Note.** SAM uses the PPA Price to calculate the [levelized cost of energy](#).

## Revenue for PPA Single Owner Financial Model

The Single Owner financial model reports three revenue values in the project cash flow.

### PPA revenue gross

The gross project revenue earned from electricity sales. For a project with a PPA price that does not

vary with time of delivery, this is the net annual energy to grid in kWh multiplied by the PPA price in \$/kWh.

#### PPA revenue lost to self-consumption

Revenue lost to grid power purchases to meet power system self-consumption loads such as inverter nighttime power consumption for photovoltaic systems, and freeze protection power and other parasitic loads for concentrating power systems.

For systems for battery storage, when the option on the [Electricity Rates](#) page is **No Electricity Rate**, revenue lost to self-consumption also includes power for battery charging.

#### PPA revenue net

The net revenue earned from electricity sales, accounting for revenue lost do self-consumption.

### Revenue for PPA Partnership and Sale Leaseback Models

#### PPA revenue to project

The project's annual revenue from electricity sales, not accounting for salvage value:

$$\text{Total PPA Revenue} = \text{Net Energy (kWh)} \times \text{PPA Price (cents/kWh)} \times 0.01 (\$/cents)$$

#### Salvage value

SAM calculates the net salvage value using the percentage you specify on the [Financial Parameters](#) page and the total installed cost from the System Costs page. The salvage value applies in the final year of the project cash flow.

For example, if you specify a 10% salvage value for a project with a 30-year analysis period, and total installed cost of \$1 million, SAM includes income in Year 30 of  $\$100,000 = \$1,000,000 \times 0.10$ .

SAM adds the salvage value as income (a negative value) to the operating expenses in the cash flow in the final year of the analysis period. The salvage value therefore reduces the operating expenses in the final year of the analysis period.

For residential projects, the salvage value has no effect on federal and state income tax because operating expenses are not taxable.

For commercial projects, because the salvage value reduces the operating expenses in the final year of the analysis period, it increases the federal and state income tax payment because operating expenses are deductible from federal and state income tax.

#### Total revenue to project

The projects annual revenue, accounting for salvage value.

$$\text{Total Revenue} = \text{Total PPA Revenue} + \text{Salvage Value}$$

Because Salvage Value is zero for all years except the last year of the analysis period, the Total Revenue and Total PPA Revenue are the same for all years except for the last year.

For the Single Owner and Leveraged Partnership Flip financial models (both of which include debt), total revenue may also include production-based [incentive](#) (PBI) amounts. For each PBI amount that you check on the [Financial Parameters](#) page under **Debt Service, Production Based Incentives (PBI) Available for Debt Service**, SAM displays a row for the PBI above the Total Revenue row, and includes the amount in the Total Revenue amount:

$$\text{Total Revenue} = \text{Total PPA Revenue} + \text{Salvage Value} + \text{PBI}$$

## Project Expenses

The eight expense rows are for annual project costs calculated from assumptions you specify on the [Financial Parameters](#) and [System Costs](#) pages.

The four O&M expenses are based on the first year or annual schedule costs you specify under Operation and Maintenance Costs on the [System Costs](#) page, and are adjusted by the inflation rate from the [Financial Parameters](#) page and optional escalation rate from the System Costs page.

### O&M Fixed expense

$$\text{O\&M Fixed Expense in Year } n = \text{Fixed Annual Cost (\$)} \times (1 + \text{Inflation Rate} + \text{Escalation Rate})^{n-1}$$

Where *Fixed Annual Cost* is from the [System Costs](#) page, and *Inflation Rate* and *Escalation Rate* are from the [Financial Parameters](#) page.

### O&M Capacity-based expense

$$\text{O\&M Capacity-based Expense in Year } n = \text{Fixed Cost by Capacity (\$/kW-yr)} \times \text{System Rated Capacity} \times (1 + \text{Inflation Rate} + \text{Escalation Rate})^{(n-1)}$$

Where *Fixed Cost by Capacity* is from the [System Costs](#) page, and *Inflation Rate* and *Escalation Rate* are from the [Financial Parameters](#) page.

The system nameplate capacity depends on technology being modeled. SAM converts the capacity value to the appropriate units (MW, kW, or W) before using it in calculations. For the photovoltaic models, the capacity is a DC power rating, and for the others it is an AC power rating. For the Solar Water Heating Model, the capacity is a thermal rating, while for the others it is an electric rating.

**Table 19. Nameplate system capacity values for each technology.**

Performance Model	System Capacity	Input Page
Detailed photovoltaic (DC)	Total Array Power (Wdc)	<a href="#">Array</a>
PVWatts (DC)	DC Rating (kWdc)	<a href="#">PVWatts Solar Array</a>
High concentration photovoltaic (DC)	System Nameplate Capacity	<a href="#">Array</a>
CSP Parabolic Trough - Physical (AC)	Estimated Net Output at Design (Nameplate) (MWe)	<a href="#">Power Cycle</a>
CSP Parabolic Trough - Empirical (AC)	Estimated Net Output at Design (MWe)	<a href="#">Power Block</a>
CSP Molten Salt Power Tower (AC)	Estimated Net Output at Design (Nameplate) (MWe)	<a href="#">Power Cycle</a>
CSP Generic Solar (AC)	Estimated Net Output at Design (Nameplate) (MWe)	<a href="#">Power Block</a>
CSP Linear Fresnel (AC)	Net nameplate capacity (MWe)	<a href="#">Power Cycle</a>
Generic System (AC)	Nameplate Capacity (kWe)	<a href="#">Power Plant</a>
Geothermal	Net Plant Output (MWe)	<a href="#">Plant and Equipment</a>
Water Heating Model (Thermal)	Nameplate Capacity (kWt)	<a href="#">SWH System</a>
Wind Power (AC)	System Nameplate Capacity (kWe)	<a href="#">Wind Farm</a>
Biopower (AC)	Nameplate Capacity, Gross (kWe)	<a href="#">Plant Specs</a>

**O&M Production-based expense**

$$O\&M \text{ Production-based Expense in Year } n = \text{Variable Cost by Generation } (\$/MWh) \times \text{Net Energy in Year } n \text{ (MWh)} * (1 + \text{Inflation Rate} + \text{Escalation Rate})^{(n-1)}$$

Where *Variable Cost by Generation* is from the [System Costs](#) page, *Net Energy* is described above, and *Inflation Rate* and *Escalation Rate* are from the [Financial Parameters](#) page.

**O&M Fuel expense**

The following performance models include a fuel cost calculation:

- Parabolic trough ([physical](#) or [empirical](#)) with fossil backup
- [Power tower](#) with fossil backup
- [Generic solar](#) system with fossil backup
- [Generic system](#) for the primary fuel cost
- [Biomass Power](#) for biomass and supplementary coal feedstock costs

**Note.** For the CSP systems listed above, SAM only considers the system to have a fossil-fired backup boiler when the fossil fill fraction variable on the Thermal Storage page is greater than zero.



For solar and generic systems listed above that consume a fuel, Fuel O&M is the annual fuel cost:

$$\text{Fuel O\&M in Year } n = \text{Annual Fuel Usage in Year One (kWh)} \times 0.003413 \text{ MMBtu per kWh} \times \text{Fossil Fuel Cost (\$/MMBtu)} \times (1 + \text{Inflation Rate} + \text{Escalation Rate})^{(n-1)}$$

Where *Annual Fuel Usage in Year One* is the quantity of fuel consumed in Year One calculated by the performance model. *Fossil Fuel Cost* and *Escalation Rate* are from the [System Costs](#) page, and *Inflation Rate* is from the [Financial Parameters](#) page.

**Note.** When you specify fuel costs using an annual schedule instead of a single value, SAM does not apply the inflation rate or escalation rate to the values you specify for each year.

For the [biomass power](#) model, SAM calculates feedstock and coal costs using feedstock usage and price values from the [Feedstock Costs](#) page:

$$\text{Biomass Feedstock Costs in Year } n = \text{Total Biomass Fuel Usage in Year One (dry tons/year)} \times \text{Biomass Fuel Cost (\$/dry ton)} \times (1 + \text{Inflation Rate} + \text{Escalation Rate})^{(n-1)}$$

$$\text{Coal Feedstock Costs in Year } n = \text{Total Coal Fuel Usage in Year One (dry tons/year)} \times \text{Coal Fuel Cost (\$/dry ton)} \times (1 + \text{Inflation Rate} + \text{Escalation Rate})^{(n-1)}$$

Where the fuel usage and fuel costs are from the [Feedstock Costs](#) page, and *Inflation Rate* and *Escalation Rate* are from the [Financial Parameters](#) page.

### Insurance expense

The insurance cost applies in Year One and later of the cash flow:

$$\text{Insurance in Year } n = \text{Total Installed Costs (\$)} \times \text{Insurance (\%)} \times (1 + \text{Inflation Rate})^{(n-1)}$$

Where *Total Installed Costs* is the value from the [System Costs](#) page, and *Insurance* and *Inflation Rate* are specified on the [Financial Parameters](#) page.

### Property tax net assessed value

The property assessed value is the value SAM uses as a basis to calculate the annual property tax payment:

$$\text{Property Assessed Value in Year One} = \text{Assessed Value}$$

Where *Assessed Value* is from the [Financial Parameters](#) page.

In Years 2 and later, the property assessed value is the Year One value adjusted by the assessed value decline value from the Financial Parameters page:

$$\text{Property Assessed Value in Year } n > 1 = \text{Assessed Value in Year One} \times [1 - \text{Assessed Value Decline} \times (n-1)]$$

Where *Assessed Value Decline* is from the Financial Parameters page, expressed as a fraction instead of a percentage.

If the value of  $1 - \text{Assessed Value Decline} \times (n-1)$  for a given year is equal to zero or less, then the *Property Assessed Value* in that year is zero.

### Property tax expense

Property taxes apply in Year One and later of the cash flow:

$$\text{Property Taxes in Year } n = \text{Property Assessed Value in Year } n (\$) \times \text{Property Tax (\%)}$$

Where *Property Assessed Value* is described above, and *Property Tax* is from the [Financial Parameters](#) page.

**Annual Developer (Lessee LLC) Margin (Sale Leaseback only)**

$$\text{Annual Developer Margin in Year } n = \text{Developer Operating Margin} \times (1 + \text{Developer Margin Escalation})^{(n-1)}$$

Where *Developer Operating Margin* and *Developer Margin Escalation* are from the [Financing](#) page.

**Total operating expense**

The total operating expense is the sum of expenses:

$$\text{Total Operating Expense in Year } n = \text{O\&M Fixed Expense} + \text{O\&M Capacity-based Expense} + \text{O\&M Production-based Expense} + \text{O\&M Fuel Expense} + \text{Insurance Expense} + \text{Property Tax Expense}$$

**EBITDA**

Earnings before interest, taxes, depreciation and amortization:

$$\text{EBITDA} = \text{Total Revenue} - \text{Total Operating Expense}$$

Where *Total Revenue* and *Total Operating Expense* are described above.

**Project Cash Flow**

The project cash flows include those from operating activities, investing activities, incentives, and issuance of equity. The pre-tax cash flow is the total project cash flow.

**Cash Flow from Operating Activities**

The cash flow from operating activities are the project earnings including interest on reserves and production-based incentives payments less interest paid on debt.

**EBITDA**

The earnings before interest, taxes, depreciation and amortization described above.

**Interest on reserves**

$$\text{Interest on Reserves} = \text{Total Reserves (\$)} \times \text{Interest on Reserves (\%)}$$

Where *Total Reserves* is the sum of *Major Equipment Reserves*, *Working Capital Reserve*, and *Debt Service Reserves*, and *Interest on Reserves* is from the [Financial Parameters](#) page.

**PBI (Federal, State, Utility, Other, Total)**

These values represent income from production-based incentive payments, calculated as described below under Incentives.

**Total project cash flow from operating activities**

$$\text{Total} = \text{EBITDA} + \text{Interest on Reserves} + \text{Total PBI} - \text{Interest}$$

**Cash Flow from Investing Activities****Purchase of property cost**

The purchase of property cost applies only in Year Zero of the cash flow. It is the sum of the total installed cost from the System Costs page and debt-related and financing costs from the Financial Parameters page less any investment-based incentives defined on the Incentives page:

$$\text{Purchase of Property Cost} = \text{Total Installed Cost} + \text{Debt Closing Costs}$$

- + Debt Up-front Fee
- + Financing Cost
- + Construction Financing Cost
- Total IBI
- Total CBI

The debt up-front fee is the product of the percent of total debt from the Financial Parameters page and the size of debt.

#### **(Increase)/Decrease in working capital reserve account**

The working capital reserve amount in Year Zero depends on the Months of Operating Costs from the [Financial Parameters](#) page and the Year One total operating expense:

$$\text{Capital Reserve in Year Zero} = \text{Total Operating Expense in Year One (\$)} \times \text{Months of Operating Costs (months)} \div 12 \text{ (months)}$$

In Year One and later:

$$\text{Capital Reserve in Year } n > 0 = \text{Capital Reserve in Year } n-1 \text{ (\$)} - \text{Total Operating Expense in Year } n \text{ (\$)} \times \text{Months of Operating Costs (months)} \div 12 \text{ (months)}$$

Where *Months of Operating Costs* is from the [Financial Parameters](#) page.

#### **(Increase)/Decrease in major equipment reserve accounts**

For each of the up to three major equipment reserve accounts that you specify on the [Financial Parameters](#) page, SAM calculates the annual amount required to ensure that sufficient funds are available in the replacement year to cover the replacement cost:

For example, in the example described below under Major Equipment Capital Spending, the annual increase in reserves is  $\$530,682/\text{year} = \$2,653,400 \div 5 \text{ years}$ .

$$\text{Increase in Major Equipment Reserve} = \text{Inflation Adjusted Replacement Cost in Replacement Year (\$)} \div \text{Replacement Year (year)}$$

The increase is shown in the cash flow as a negative value.

In the year that the replacement occurs (in this example, Year 5), the decrease in major equipment reserve account is  $\$2,122,727 = \$2,653,400 - \$430,682$ .

$$\text{Decrease in Major Equipment Reserve in Replacement Year} = \text{Inflation Adjusted Replacement Cost in Replacement Year} - \text{Increase in Major Equipment Reserve}$$

The decrease is shown in the cash flow as a positive value.

#### **Major equipment capital spending**

For each of the up to three major equipment reserve accounts that you specify on the [Financial Parameters](#) page, the inflation-adjusted amount is reported in the year that you specify.

For example, if you specify a \$2,500 (in Year One dollars) replacement cost with a 5 year replacement frequency, and an inflation rate of 1.5% on the Financial Parameters page, SAM reports a major equipment capital spending amounts in years 5, 10, 15 etc. For Year 5, the amount would be  $\$2,653,400 = \$2,500,000 \times (1 + 0.015)^4$ .

In each year that the replacement occurs:

$$\text{Capital Spending} = - \text{Replacement Cost (Year One \$)} \times (1 + \text{Inflation Rate})^{(\text{Replacement Year} - 1)}$$

The value is negative because it represents an expense or outflow.

#### **Total cash flow from investing activities**

The total cash flow from investing activities is the sum of purchase property cost, reserve account

deposits or withdrawals, and capital spending:

$$\text{Total in Year Zero} = \text{Purchase of Property Cost} + \text{Debt Service (increase)/decrease} + \text{Working Capital (increase)/decrease}$$

$$\text{Total in Year } n>0 = \text{Working Capital (increase)/decrease} + \text{Major Equipment (increase)/decrease} + \text{Reserve Capital Spending}$$

## Cash Flow from Financing Activities

Cash flows from financing activities include income from incentive payments, equity capital, and, for Single Owner and Leveraged Partnership Flip, debt capital.

### Total IBI

The total investment-based incentive amount, described below.

### Total CBI

The total capital-based incentive amount, described below.

### Equity Capital

The equity capital invested in the project.

$$\text{Issuance of Equity in Year Zero} = \text{Total Installed Cost} + \text{Financing Cost} - (\text{Debt Funding} + \text{Total IBI} + \text{Total CBI})$$

Where *Total Installed Cost* is the project capital cost from the [System Costs](#) page, *Financing Cost* is the total debt costs and development fees, *Debt* (Single Owner and Leveraged Partnership Flip only) is the debt funding amount described below, and *Total IBI* and *Total CBI* are the investment-based incentive and capacity based incentive amounts described below.

### Total project cash flow from financing activities

The total cash flow from financing activities is the sum of equity capital, incentive payments, and debt capital.

$$\text{Total in Year Zero} = \text{Issuance of Equity} + \text{Total IBI} + \text{Total CBI} + \text{Debt Funding}$$

$$\text{Total in Year } n>0 = \text{Debt Repayment}$$

### Project total pre-tax cash flow

The pre-tax cash flow is the cash flow and accounts for operating expenses, investment earnings, and incentive payments.

$$\text{Total Project Pre-tax Cash Flow in Year Zero} = \text{Issuance of Equity}$$

Where *Issuance of Equity* is the equity investment in the project described above.

$$\text{Total Project Pre-tax Cash Flow in Year } n>0 = \text{Total Cash Flows from Operating Activities} + \text{Total Cash Flows from Investing Activities} + \text{Total Incentives}$$

## Total Project Returns

The total project returns rows of the cash flow table show pre- and after-tax cash flows and returns from the project perspective. Returns from each partner's perspective appear under the Partners Returns heading and are described below.

### Project pre-tax returns

**Total project pre-tax returns**

The total annual pre-tax cash flow is the cash flow and accounts for operating expenses, investment earnings, and incentive payments.

$$\text{Pre-tax Cash Flow in Year Zero} = \text{Issuance of Equity}$$

Where *Issuance of Equity* is the equity investment in the project described above.

$$\text{Pre-tax Cash Flow in Year } n > 0 = \text{Total Cash Flows from Operating Activities} + \text{Total Cash Flows from Investing Activities} + \text{Total Incentives}$$

**Project pre-tax cumulative IRR**

SAM calculates the cumulative IRR for each year N of the cash flow. The cumulative IRR in a given Year N is the discount rate that results in a value of zero for the present value of the discounted pre-tax cash flows up to Year N:

$$NPV = \sum_{n=0}^N \frac{C_{PreTax,n}}{(1 + IRR)^n} = 0$$

Where  $C_{PreTax,n}$  is the pre-tax cash flow described above.

**Project pre-tax cumulative NPV**

The cumulative net present value in a given Year N is the sum of the present values of the pre-tax cash flows up to Year N:

$$NPV = \sum_{n=0}^N \frac{C_{PreTax,n}}{(1 + d_{nominal})^n}$$

Where  $C_{PreTax,n}$  is the pre-tax cash flow described above,  $d_{nominal}$  is the nominal discount rate from the [Financial Parameters](#) page.

**Project after-tax returns****Cash**

The pre-tax cash flow, described above.

**Total project after-tax returns**

The total annual after-tax cash flow is the sum of the pre-tax cash flow and tax credits less income tax payments:

$$\text{After-tax Cash Flow in Year Zero} = \text{Pre-tax Cash Flow in Year Zero}$$

$$\text{After-tax Cash Flow in Year One} = \text{Pre-tax Cash Flow in Year One} + \text{Total ITC} + \text{Total PTC} + \text{Project Tax Benefit}$$

$$\text{After-tax Cash Flow in Year } n > 1 = \text{Pre-tax Cash Flow in Year } n + \text{Total PTC} + \text{Project Tax Benefit}$$

**Project after-tax cumulative IRR**

SAM calculates the cumulative IRR for each year N of the cash flow. The cumulative IRR in a given Year N is the discount rate that results in a value of zero for the present value of the discounted pre-tax cash flows up to Year N:

$$NPV = \sum_{n=0}^N \frac{C_n}{(1 + IRR)^n} = 0$$

Where  $C_{AfterTax,n}$  is the after-tax cash flow described above.

### Project after-tax cumulative NPV

The cumulative net present value in a given Year N is the sum of the present values of the pre-tax cash flows up to Year N:

$$NPV = \sum_{n=0}^N \frac{C_{AfterTax,n}}{(1 + d_{nominal})^n}$$

Where  $C_{AfterTax,n}$  is the after-tax cash flow described above, and  $d_{nominal}$  is the nominal discount rate from the [Financial Parameters](#) page.

### Project LCOE

SAM reports quantities used in the LCOE calculation in the cash flow table for reference. For a description of the LCOE see [Levelized Cost of Energy \(LCOE\)](#).

#### Project PPA revenue

The total PPA revenue is the project's annual revenue from electricity sales, not accounting for salvage value:

$$Project\ PPA\ Revenue = Net\ Energy\ (kWh) \times PPA\ Price\ (cents/kWh) \div 100\ (cents/\$)$$

#### Net Energy (kWh)

The total amount of electricity generated by the system in AC kilowatt-hours for each year. See description above

#### NPV of PPA revenue

The present value of the annual PPA revenue streams over the analysis period used as the numerator of the LCOE equation:

$$NPV(\text{Revenue}) = \sum_{n=0}^N \frac{R_{PPA,n}}{(1 + d_{nominal})^n}$$

Where  $R_{PPA,n}$  is the revenue from electricity sales-tax cash flow described above, and  $d_{nominal}$  is the nominal discount rate from the [Financial Parameters](#) page.

#### NPV of net annual energy (nominal)

The LCOE calculation requires a discounted energy term in the denominator. The value discounted using the nominal discount rate is for the nominal LCOE equation.

$$NPV(\text{Energy Nominal}) = \sum_{n=0}^N \frac{Q_n}{(1 + d_{nominal})^n}$$

Where  $Q_n$  is the annual energy value described above, and  $d_{nominal}$  is the nominal discount rate from the [Financial Parameters](#) page.

**Project Nominal LCOE**

$$\text{Project Nominal LCOE} = \text{NPV(Revenue)} / \text{NPV(Energy Nominal)}$$

**NPV of net annual energy (real)**

The LCOE calculation requires a discounted energy term in the denominator. The value discounted using the real discount rate is for the real LCOE equation.

$$\text{NPV(Energy Real)} = \sum_{n=0}^N \frac{Q_n}{(1 + d_{real})^n}$$

Where  $Q_n$  is the annual energy value described above, and  $d_{real}$  is the nominal discount rate from the [Financial Parameters](#) page.

**Project Real LCOE**

$$\text{Project Real LCOE} = \text{NPV(Revenue)} / \text{NPV(Energy Real)}$$

**Partners Returns**

The partners returns are the IRR, NPV, and taxes from each project partner's perspective.

**Tax Investor**

The tax investor cash flows represent the tax investor share of project cash flows.

**Tax Investor Pre-Tax Returns****Total tax investor pre-tax returns**

In Year Zero, the tax investor pre-tax cash flow is the portion of equity capital allocated to the tax investor:

$$\text{Tax Investor Pre-Tax Cashflow in Year Zero} = \text{Tax Investor Share of Equity Contribution (\%)} \times \text{Issuance of Equity (\$)}$$

Where *Tax Investor Share of Equity Contribution* is from the [Financial Parameters](#) page.

For years before the flip target is reached:

$$\text{Tax Investor Pre-Tax Cashflow in Year } n > 1 = \text{Tax Investor Pre-flip Share of Project Cash (\%)} \times \text{Total Project Pre-tax Cash Flow (\$)}$$

For years after the flip target is reached:

$$\text{Tax Investor Pre-Tax Cashflow in Year } n > 1 = \text{Tax Investor Post-flip Share of Project Cash (\%)} \times \text{Total Project Pre-tax Cash Flow (\$)}$$

Where the pre- and post-flip share of project cash percentages are from the [Financial Parameters](#) page.

**Tax investor cumulative IRR**

Cumulative pre-tax IRR from the tax investor perspective for each year N of the cash flow. The cumulative IRR in a given Year N is the discount rate that results in a value of zero for the present value of the discounted pre-tax cash flows up to Year N:

$$\text{NPV} = \sum_{n=0}^N \frac{C_{PreTax,n}}{(1 + \text{IRR})^n} = 0$$

Where  $C_{PreTax,n}$  is the tax investor pre-tax cash flow described above.

For years when there is no mathematical solution, SAM reports a value of zero.

### Tax investor cumulative NPV

Cumulative pre-tax net present value from the tax investor perspective in a given Year N is the sum of the present values of the pre-tax cash flows up to Year N:

$$NPV = \sum_{n=0}^N \frac{C_{PreTax,n}}{(1 + d_{nominal})^n}$$

Where  $C_{PreTax,n}$  is the tax investor pre-tax cash flow described above,  $d_{nominal}$  is the nominal discount rate from the [Financial Parameters](#) page.

## Tax Investor After-Tax Returns

### Tax investor cash (total pre-tax returns)

The tax investor pre-tax cash flow, described above.

### ITC

The tax investor's share of the ITC amount applies to the tax investor's Year One cash flow:

$$\text{Investment Tax Credit in Year One} = \text{Tax Investor Share of Equity Contribution (\%)} \times (\text{Federal ITC (\$)} + \text{State ITC (\$)})$$

Where *Tax Investor Share of Equity Contribution* is from the [Financial Parameters](#) page, and *Federal ITC* and *State ITC* are described below.

### PTC

The tax investor's share of the PTC applies in Years One and later of the tax investor's cash flow.

For years before the flip target is reached:

$$\text{Production Tax Credit in Year } n = \text{Tax Investor Pre-flip Share of Project Cash (\%)} \times (\text{Federal PTC (\$)} + \text{State PTC (\$)})$$

For years after the flip target is reached:

$$\text{Production Tax Credit in Year } n = \text{Tax Investor Post-flip Share of Project Cash (\%)} \times (\text{Federal PTC (\$)} + \text{State PTC (\$)})$$

Where the pre- and post-flip share of project cash values are from the [Financial Parameters](#) page, and *Federal PTC* and *State PTC* are described below.

### Tax investor share of project tax

The tax investor's share of the project's tax payment or refund. A positive value indicates a tax refund, and a negative value indicates a tax payment.

For years before the flip target is reached:

$$\text{Tax Investor Share of Project Tax in Year } n = \text{Tax Investor Pre-flip Share of Project Cash (\%)} \times \text{Project Tax Benefit/(Liability) (\$)}$$

For years after the flip target is reached:

$$\text{Tax Investor Share of Project Tax in Year } n = \text{Tax Investor Post-flip Share of Project Cash (\%)} \times \text{Project Tax Benefit/(Liability) (\$)}$$

Where the pre- and post-flip share of project cash values are from the [Financial Parameters](#) page, and



Project Tax Benefit/(Liability) is the tax amount owed.

#### Total tax investor after-tax returns

The tax investor's total after-tax cash flow.

$$\text{Total} = \text{Cash} + \text{Investment Tax Credit} + \text{Production Tax Credit} + \text{Share of Project Tax Benefit/} \\ \text{(Liability)}$$

#### Tax investor cumulative IRR

Cumulative after-tax IRR from the tax investor perspective for each year N of the cash flow. The cumulative IRR in a given Year N is the discount rate that results in a value of zero for the present value of the discounted pre-tax cash flows up to Year N:

$$NPV = \sum_{n=0}^N \frac{C_n}{(1 + IRR)^n} = 0$$

Where  $C_{PreTax,n}$  is the tax investor after-tax cash flow described above.

For years when there is no mathematical solution, SAM reports a value of zero.

#### Tax investor cumulative NPV

Cumulative after-tax net present value from the tax investor perspective in a given Year N is the sum of the present values of the pre-tax cash flows up to Year N:

$$NPV = \sum_{n=0}^N \frac{C_{AfterTax,n}}{(1 + d_{nominal})^n}$$

Where  $C_{PreTax,n}$  is the tax investor after-tax cash flow described above,  $d_{nominal}$  is the nominal discount rate from the [Financial Parameters](#) page.

#### Tax investor maximum IRR

The greater of the Year One Cumulative IRR and the Year n Cumulative IRR.

## Developer

The Developer cash flows represent the developer share of project cash flows.

### Developer Pre-Tax Returns

#### Pre-tax development fee

A fee received by the developer.

$$\text{Pre-tax Developer Development Fee in Year Zero} = \text{Development Fee}$$

Where *Development Fee* is from the [Financial Parameters](#) page.

#### Total developer pre-tax returns

The pre-tax cash flow from the developer's perspective.

$$\text{Developer Pre-tax Cash Flow in Year Zero} = \text{Equity Investment in Year Zero} + \text{Pre-tax Developer} \\ \text{Development Fee}$$

$$\text{Developer Pre-tax Cash Flow in Year } n > 0 = \text{Total Project After-tax Cash Flow} - \text{Tax Investor Pre-tax} \\ \text{Cash Flow}$$

**Developer pre-tax cumulative IRR**

Cumulative pre-tax IRR from the developer perspective for each year N of the cash flow. The cumulative IRR in a given Year N is the discount rate that results in a value of zero for the present value of the discounted pre-tax cash flows up to Year N:

$$NPV = \sum_{n=0}^N \frac{C_{PreTax,n}}{(1 + IRR)^n} = 0$$

Where  $C_{PreTax,n}$  is the tax investor after-tax cash flow described above.

For years when there is no mathematical solution, SAM reports a value of zero.

**Developer pre-tax cumulative NPV**

Cumulative pre-tax net present value from the developer perspective in a given Year N is the sum of the present values of the pre-tax cash flows up to Year N:

$$NPV = \sum_{n=0}^N \frac{C_{PreTax,n}}{(1 + d_{nominal})^n}$$

Where  $C_{PreTax,n}$  is the tax investor after-tax cash flow described above,  $d_{nominal}$  is the nominal discount rate from the [Financial Parameters](#) page.

**Developer pre-tax IRR**

The cumulative tax investor pre-tax IRR in the flip year defined on the [Financial Parameters](#) page.

For years when there is no mathematical solution, SAM reports a value of zero.

**Developer pre-tax NPV**

The cumulative tax investor pre-tax NPV in the flip year defined on the [Financial Parameters](#) page.

**Developer After-Tax Returns****Equity Investment**

The developer's share of the project equity capital.

$$\text{Equity Investment in Year Zero} = \text{Total Project Equity Investment in Year Zero} - \text{Tax Investor Equity Investment in Year Zero}$$

**Development Fee**

A fee received by the developer.

$$\text{Development Fee in Year Zero} = \text{Development Fee}$$

Where *Development Fee* is from the [Financial Parameters](#) page.

**Cash**

The pre-tax cash flow from the developer perspective.

$$\text{Cash in Year Zero} = \text{Equity Investment} + \text{Development Fee}$$

$$\text{Cash in Year } n > 0 = \text{Developer Pre-tax Cash Flow}$$

**ITC**

The developer's share of the ITC amount applies to the tax developer's Year One cash flow:

$$\text{Investment Tax Credit in Year One} = \text{Developer Share of Equity Contribution (\%)} \times (\text{Federal ITC (\$)})$$

+ State ITC (\$) )

Where *Developer Share of Equity Contribution* is from the [Financial Parameters](#) page, and *Federal ITC* and *State ITC* are described below.

### PTC

The developer's share of the PTC applies in Years One and later of the developer's cash flow.

For years before the flip target is reached:

$$\text{Production Tax Credit in Year } n = \text{Developer Pre-flip Share of Project Cash (\%)} \times (\text{Federal PTC (\$)} + \text{State PTC (\$)})$$

For years after the flip target is reached:

$$\text{Production Tax Credit in Year } n = \text{Developer Post-flip Share of Project Cash (\%)} \times (\text{Federal PTC (\$)} + \text{State PTC (\$)})$$

Where the pre- and post-flip share of project cash values are from the [Financial Parameters](#) page, and *Federal PTC* and *State PTC* are described below.

### Developer share of project tax

The developer's share of the project's tax payment or refund. A positive value indicates a tax refund, and a negative value indicates a tax payment.

For years before the flip target is reached:

$$\text{Developer Share of Project Tax in Year } n = \text{Developer Pre-flip Share of Project Cash (\%)} \times \text{Project Tax Benefit/(Liability) (\$)}$$

For years after the flip target is reached:

$$\text{Developer Share of Project Tax in Year } n = \text{Developer Post-flip Share of Project Cash (\%)} \times \text{Project Tax Benefit/(Liability) (\$)}$$

Where the pre- and post-flip share of project cash values are from the [Financial Parameters](#) page

### Total developer after-tax returns

The developer's total after-tax cash flow.

$$\text{Total Developer After-tax Returns} = \text{Cash} + \text{Investment Tax Credit} + \text{Production Tax Credit} + \text{Share of Project Tax Benefit/(Liability)}$$

### Developer after-tax cumulative IRR

Cumulative after-tax IRR from the developer perspective for each year  $n$  of the cash flow. The cumulative IRR in a given Year  $n$  is the discount rate that results in a value of zero for the present value of the discounted pre-tax cash flows up to Year  $N$ :

$$NPV = \sum_{n=0}^N \frac{C_n}{(1 + IRR)^n} = 0$$

Where  $C_{PreTax,n}$  is the developer after-tax cash flow described above.

For years when there is no mathematical solution, SAM reports a value of zero.

### Developer after-tax cumulative NPV

Cumulative after-tax net present value from the developer perspective in a given Year  $n$  is the sum of the present values of the pre-tax cash flows up to Year  $N$ :

$$NPV = \sum_{n=0}^N \frac{C_{AfterTax,n}}{(1 + d_{nominal})^n}$$

Where  $C_{PreTax,n}$  is the developer after-tax cash flow described above,  $d_{nominal}$  is the nominal discount rate from the [Financial Parameters](#) page.

#### Developer after-tax IRR

The cumulative developer pre-tax IRR in the flip year defined on the [Financial Parameters](#) page.

For years when there is no mathematical solution, SAM reports a value of zero.

#### Developer after-tax NPV

The cumulative developer pre-tax NPV in the flip year defined on the [Financial Parameters](#) page.

## Incentives

The incentive cash flow rows show the value of cash incentives and tax credits, which are used to calculate cash flows described above.

#### IBI (Investment Based Incentives)

Each IBI (federal, state, utility, other) applies in Year Zero of the project cash flow.

Because you can specify each IBI on the [Incentives](#) page as either an amount or a percentage, SAM calculates the value of each IBI as the sum of two values:

$$IBI \text{ as Amount} = \text{Amount}$$

$$IBI \text{ as Percentage} = \text{Total Installed Cost (\$)} \times \text{Percentage (\%)}, \text{ up to Maximum}$$

$$IBI \text{ in Year 0} = IBI \text{ as Amount} + IBI \text{ as Percentage}$$

Where *Amount*, *Percentage* and *Maximum* are the values that you specify on the [Incentives](#) page, and *Total Installed Cost* is from the [System Costs](#) page.

*Total IBI* is the sum of the four IBI values (federal, state, utility, other).

**Note.** The IBI amount reduces the after tax cost flow in Year Zero, and the debt balance in Year One. This is because SAM assumes that debt payments begin in Year One, when the project is generating or saving electricity.

#### CBI (Capacity Based Incentives)

Each CBI (federal, state, utility, other) applies in Year Zero of the project cash flow:

$$CBI \text{ in Year 0} = \text{System Capacity (W)} \times \text{Amount (\$/W)}, \text{ up to Maximum}$$

Where *System Capacity* is the rated capacity of the system, and *Amount* and *Maximum* are the values you specify on the [Incentives](#) page.

*Total CBI* is the sum of the four CBI values (federal, state, utility, other).

The system nameplate capacity depends on technology being modeled. SAM converts the capacity value to the appropriate units (MW, kW, or W) before using it in calculations. For the photovoltaic models, the capacity is a DC power rating, and for the others it is an AC power rating. For the Solar Water Heating Model, the capacity is a thermal rating, while for the others it is an electric rating.

**Table 20. Nameplate system capacity values for each technology.**

Performance Model	System Capacity	Input Page
Detailed photovoltaic (DC)	Total Array Power (Wdc)	<a href="#">Array</a>
PVWatts (DC)	DC Rating (kWdc)	<a href="#">PVWatts Solar Array</a>
High concentration photovoltaic (DC)	System Nameplate Capacity	<a href="#">Array</a>
CSP Parabolic Trough - Physical (AC)	Estimated Net Output at Design (Nameplate) (MWe)	<a href="#">Power Cycle</a>
CSP Parabolic Trough - Empirical (AC)	Estimated Net Output at Design (MWe)	<a href="#">Power Block</a>
CSP Molten Salt Power Tower (AC)	Estimated Net Output at Design (Nameplate) (MWe)	<a href="#">Power Cycle</a>
CSP Generic Solar (AC)	Estimated Net Output at Design (Nameplate) (MWe)	<a href="#">Power Block</a>
CSP Linear Fresnel (AC)	Net nameplate capacity (MWe)	<a href="#">Power Cycle</a>
Generic System (AC)	Nameplate Capacity (kWe)	<a href="#">Power Plant</a>
Geothermal	Net Plant Output (MWe)	<a href="#">Plant and Equipment</a>
Water Heating Model (Thermal)	Nameplate Capacity (kWt)	<a href="#">SWH System</a>
Wind Power (AC)	System Nameplate Capacity (kWe)	<a href="#">Wind Farm</a>
Biopower (AC)	Nameplate Capacity, Gross (kWe)	<a href="#">Plant Specs</a>

**PBI (Performance Based Incentive)**

Each PBI (federal, state, utility, other) applies in Years One and later of the project cash flow, up to the number of years you specify:

$$PBI \text{ in Year } n = \text{Amount } (\$/kWh) \times \text{Energy in Year } n \text{ (kWh)} \times (1 + \text{Escalation})^{(n-1)}, \text{ up to Term}$$

Where *Amount*, *Term*, and *Escalation* are the values you specify on the [Incentives](#) page, and *Energy* is the value displayed in Energy row of the cash flow table (described above).

**Note.** If you use an annual schedule to specify year-by-year PBI amounts, SAM ignores the escalation rate.

*Total PBI* is the sum of the four PBI amounts (federal, state, utility, other).

**Important Note!** If you specify a PBI amount on the Cash Incentives page, be sure to also specify the incentive term. If you specify a term of zero, the incentive will not appear in the cash flow table.

**PTC (Production Tax Credit)**

The state and federal PTC each apply in Year One and later of the project cash flow, up to the number of years you specify:

$$PTC \text{ in Year } n = \text{Amount } (\$/kWh) \times (1 + \text{Escalation})^{(n-1)} \times \text{Energy in Year } n \text{ (kWh)}$$

Where *Amount*, *Term*, and *Escalation* are the values you specify on the [Incentives](#) page, and *Energy* is the value displayed in the Energy row of the cash flow table (described above).

SAM rounds the product  $\text{Amount } (\$/kWh) \times (1 + \text{Escalation})^{(n-1)}$  to the nearest multiple of 0.1 cent as described in Notice 2010-37 of [IRS Bulletin 2010-18](#).

**Note.** If you specify year-by-year PTC rates on the Incentives page using an Annual Schedule instead of a single value, SAM ignores the PTC escalation rate.

### ITC (Investment Tax Credit)

The state and federal ITC each apply only in Year One of the project cash flow. For ITCs that you specify as a fixed amount:

$$ITC \text{ in Year One} = \text{Amount}$$

Where *Amount* is the value you specify in the [Incentives](#) page.

For ITCs that you specify as a percentage of total installed costs:

$$ITC \text{ in Year One} = ( \text{Total Installed Cost } (\$) - \text{ITC Basis Reduction } (\$) ) \times \text{Percentage } (\%), \text{ up to Maximum}$$

Where *Total Installed Cost* is from the [System Costs](#) page, and *Percentage* and *Maximum* are the values you specify on the [Incentives](#) page.

*ITC Basis Reduction* applies only to the Commercial and PPA financial models, and depends on whether the project includes any investment-based incentives (IBI) or capacity-based incentives (CBI) specified on the [Incentives](#) page with checked boxes under **Reduces Depreciation and ITC Bases**. For each IBI or CBI with a check mark, SAM subtracts the incentive amount from the total installed cost to calculate the ITC.

$$ITC \text{ Basis Reduction} = IBI + CBI$$

Where *IBI* and *CBI* are the incentives that you have specified reduce the ITC basis on the [Incentives](#) page.

### Debt

The debt amounts depend on the following inputs from the [Financial Parameters](#) page:

- Debt Rate
- DSCR

### Debt Repayment

The debt repayment rows show the size of annual debt payments.

### Debt Sizing (Constant Payments)

When you specify the debt percent as an input on the Financial Parameters page, SAM assumes constant total annual debt payments so that the annual debt service coverage ratio (DSCR) varies from year to year. In this mode, SAM reports the minimum DSCR in the Metrics table.

### Debt Sizing (Constant DSCR)

When you specify the DSCR as an input on the Financial Parameters page, SAM assumes a constant annual DSCR and sculpted debt, where annual debt payments vary to match cash available for debt

services. In this mode, SAM reports the debt percent in the Metrics table.

## Reserve Accounts

Reserve accounts include debt service, working capital reserve, and major equipment replacement reserves. The reserve account amounts depend on the following inputs from the Financial Parameters page:

- Inflation Rate
- Debt Service Reserve Account (months P&I)
- Working Capital Reserve Months of Operating Costs
- Major Equipment Replacement Reserve Account [1-3] Frequency (years)
- Major Equipment Replacement [1-3] (Year 1 \$)

### Lease Payment Reserve (Sale Leaseback only)

$$\text{Lease Payment Reserve} = \text{Tax Investor (Lessor) Required Lease Payment Reserve (months)} \div 12 \times \text{Total Developer Pre-tax Cash Flow from Operating Activities in Year } n+1$$

### Debt Service Reserve

The debt service reserve applies in Year Zero and later:

$$\text{Debt Service Reserve} = \text{Debt Service Reserve Account (months P\&I)} \div 12 \times \text{Total P\&I in Year } n+1$$

Where *Debt Service Reserve Account (months P&I)* is from the Financial Parameters page, and *Total P&I in Year n+1* is described under Debt above.

### Working Capital Reserve

Working capital reserve applies in Year Zero and later:

$$\text{Working Capital Reserve} = \text{Months of Operating Costs} \times \text{Operating Expenses in Year } n+1$$

Where *Months of Operating Costs* is from the Financial Parameters page, and *Operating Expenses in Year n+1* is described above.

### Major Equipment Replacement Reserves

You can specify up to three major equipment reserve accounts on the Financial Parameters page. For each account, the amount applies in Year One and later of the cash flow:

$$\text{Major Equipment Reserve in Year } n = \text{Major Equipment Reserve in Year } n-1 + \text{Funding} + \text{Release of Funds}$$

Where Major Equipment Reserve in Year Zero = 0, and:

$$\text{Funding} = \text{Release of Funds in Year of Next Replacement} \div \text{Replacement Frequency}$$

$$\text{Release of Funds in Year of Next Replacement} = - \text{Replacement Cost in Year One } \$ \times (1 + \text{Inflation Rate})^{(n-1)}$$

Where *Replacement Frequency*, *Replacement Cost in Year One \$*, and *Inflation Rate* are from the Financial Parameters page

## Depreciation and ITC Tables

The federal and state Depreciation and ITC tables show the depreciable basis calculation for each of the up to seven depreciation classes for federal and state tax purposes:

- The total depreciable amount includes the total installed cost, development fee, equity closing cost, debt service reserve, working capital reserve, and for the Sale Leaseback financial model, the lease

payment reserve.

- The depreciation class allocations on the [Financial Parameters](#) page determine how the depreciable basis is allocated to the different depreciation classes (MACRS 5-yr, Straight Line, etc.).
- For each state and federal IBI and CBI with **Reduces Depreciation and ITC Bases** checked on the [Incentives](#) page, the full incentive amount reduces the depreciable basis.
- For each state and federal ITC with **Reduces Depreciation Basis** checked on the [Incentives](#) page, 50% of the tax credit amount reduces the depreciable basis.
- For each depreciation class with a checked box under **Bonus Depreciation** on the Financial Parameters page, the depreciable basis is the product of the bonus depreciation percentage and the adjusted depreciable basis. (The adjusted depreciable basis is the total depreciable after incentives and tax credit adjustments.)
- For state and federal taxes, depreciation for major equipment replacement reserves uses the class specified on the Financial Parameters page.

The depreciation amounts depend on the total installed cost from the [System Costs](#) page, and the following inputs from other pages.

From the Financial Parameters page:

- Development Fee
- Debt Closing Costs
- Debt Closing Fee
- Equity Closing Cost
- Construction Financing
- Other Financing Cost

From the [Incentives](#) page:

- State ITC as Percentage
- State ITC Maximum
- State ITC as Amount
- Federal ITC as Percentage
- Federal ITC Maximum
- Federal ITC as Amount
- Status of **Reduces Depreciation Basis** check boxes
- The amounts and percentages of any incentive with **Reduces Depreciation and ITC Bases** checked

From the [Depreciation](#) page:

- Allocations for each depreciation class
- Bonus depreciation amounts and applicable depreciation classes
- ITC qualification status of depreciation classes

The depreciation amounts also depend on the following cash flow values:

- Debt service reserve
- Working capital reserve
- IBI (only for incentives shown to reduce depreciation basis on Incentives page)
- CBI (only for incentives shown to reduce depreciation basis on Incentives page)
- Debt funding



- For state depreciation, the federal ITC basis disallowance amounts for each depreciation class
- For federal depreciation, the state ITC basis disallowance amounts for each depreciation class

### Gross Depreciable Basis with IBI and CBI Reductions Before ITC Reductions

For each depreciable class, the depreciable basis before reduction by the ITC is the gross depreciable basis less IBI and CBI amounts for incentives on the Cash Incentives page with **Reduces Depreciation and ITC Bases** checked.

**Note.** The IBI and CBI reduce the depreciation basis for state taxes only when **State** under **Reduces Depreciation and ITC Bases** is checked. Similarly, the IBI and CBI reduce the depreciation basis for federal taxes only when **Federal** under **Reduces Depreciation and ITC Bases**.

#### % of Total Depreciable Basis

The normalized allocation for each depreciation class allocation:

$$\% \text{ of Total Depreciable Basis} = \text{Allocation} \div \text{Sum of Allocations}$$

Where *Allocation* is the percentage for the given depreciable class, and *Sum of Allocations* is the sum of all allocations from the Financial Parameters page.

#### Gross Amount Allocated

The gross depreciable basis before reductions for each depreciation class:

$$\text{Gross Amount Allocated} = \% \text{ of Total Depreciable Basis} \times \text{Total Depreciable Amount}$$

Where % of Total Depreciable Basis is described above, and

$$\text{Total Depreciable Amount} = \text{Total Installed Cost} + \text{Development Fee} + \text{Equity Closing Cost} + \text{Debt Closing Costs} + \text{Debt Closing Fee} \times \text{Funding} + \text{Debt Service Reserve} + \text{Working Capital Reserve} + \text{Lease Payment Reserve}$$

Where *Total Installed Cost* is from the [System Costs](#) page; *Development Fee*, *Equity Closing Cost*, *Debt Closing Costs*, and *Debt Closing Fee* are from the [Financial Parameters](#) page; and *Debt Service Reserve*, *Working Capital Reserve* and *Lease Payment Reserve* (Sale Leaseback financial model only) are other values in the cash flow described above

#### Reduction: IBI

The reduction in depreciation basis from IBI payments:

$$\text{Reduction IBI} = \text{Total IBI that Reduce Depreciation} \times \% \text{ of Total Depreciable Basis}$$

Where *Total IBI that Reduce Depreciation* is the sum of IBI values in the cash flow for incentives with **Reduces Depreciation and ITC Bases** checked on the [Incentives](#) page. For the state depreciation table, **State** must be checked for the incentive to reduce the state depreciation basis. For the federal depreciation table, **Federal** must be checked. % of *Total Depreciable Basis* is the allocation for the depreciation class described above.

#### Reduction: CBI

The reduction in depreciation basis from CBI payments:

$$\text{Reduction CBI} = \text{Total CBI that Reduce Depreciation} \times \% \text{ of Total Depreciable Basis}$$

Where *Total CBI that Reduce Depreciation* is the sum of CBI values in the cash flow for incentives with **Reduces Depreciation and ITC Bases** checked on the [Incentives](#) page. For the state depreciation table, **State** must be checked for the incentive to reduce the state depreciation basis. For the federal depreciation table, **Federal** must be checked. % of *Total Depreciable Basis* is the allocation for the

depreciation class described above.

### Depreciable Basis Prior to ITC

The depreciable basis reduced by CBI and IBI amounts:

$$\text{Depreciable Basis Prior to ITC} = \text{Gross Amount Allocated} - \text{Reduction: IBI} - \text{Reduction: CBI}$$

### ITC Reduction

For each ITC on the [Incentives](#) page with **Reduces Depreciation Basis** checked, 50% of the ITC amount can be included in the depreciable basis for each depreciable class with **ITC Qualification** checked on the [Depreciation](#) page. SAM calculates the ITC reduction amount for ITCs that you specify on the Incentives page a percentage of the total installed costs with a maximum amount, and ITCs that you specify as a fixed amount.

**Note.** The ITC reduces the depreciation basis for state taxes only when **State** under **Reduces Depreciation Basis** is checked on the [Incentives](#) page, and when **State** is checked under **ITC Qualification** for the depreciation class on the [Depreciation](#) page. Similarly, the ITC reduces the depreciation basis for federal taxes only when **Federal** is checked under **Reduces Depreciation Basis** and under **ITC Qualification** for the depreciation class.

For each ITC specified as a percentage and maximum on the Incentives page, the *ITC Basis Disallowance* is the amount that may be available for depreciation basis reduction. (The ITC Reduction amounts are the amounts actually available.):

#### ITC Qualifying Costs

For depreciation classes with **ITC Qualification** checked on the [Depreciation](#) page:

$$\text{ITC Qualifying Costs} = \text{Depreciable Basis Prior to ITC}$$

#### % of ITC Qualifying Costs

For each depreciable class:

$$\% \text{ of ITC Qualifying Costs} = \text{ITC Qualifying Costs} \div \text{Total Depreciable Basis Prior to ITC}$$

Where *Total Depreciable Basis Prior to ITC* is the sum of *Depreciable Basis Prior to ITC* for all depreciable classes.

#### ITC Amount

$$\text{ITC Amount} = \% \text{ of ITC Qualifying Costs} \times \text{ITC Qualifying Costs}$$

#### ITC Basis Disallowance

The ITC depreciation basis disallowance is 50% of the ITC amount:

$$\text{ITC Basis Disallowance} = \text{ITC Amount} \times 0.5$$

For each ITC specified as a fixed amount on the Incentives page, the ITC Basis Disallowance is the amount that may be available for depreciation basis reduction. (The ITC Reduction amounts are the amounts actually available.):

#### ITC Amount

For each depreciable class, the Total ITC Amount is the amount that may be available for depreciation reduction:

$$\text{ITC Amount} = \text{Total ITC Amount} \times \% \text{ of ITC Qualifying Costs}$$

Where, for the state depreciation table, *Total ITC Amount* is the state ITC amount from the [Incentives](#)

page. For the federal depreciation table, *Total ITC Amount* is the federal ITC amount from the Incentives page.

### ITC Basis Disallowance

The ITC depreciation basis disallowance is 50% of the ITC amount:

$$\text{ITC Basis Disallowance} = \text{ITC Amount} \times 0.5$$

The depreciable basis after ITC reduction is the sum of the total ITC basis disallowance values for the ITCs with **Reduces Depreciation Basis** checked on the Incentives pages.

### ITC Reduction: State

$$\text{ITC Reduction: State} = \text{ITC Basis Disallowance (ITC as \%)} + \text{ITC Basis Disallowance (ITC as Fixed Amount)}$$

Where the ITC basis disallowance values are from the state depreciation table for the ITCs that reduce depreciation basis.

### ITC Reduction: Federal

$$\text{ITC Reduction: Federal} = \text{ITC Basis Disallowance (ITC as \%)} + \text{ITC Basis Disallowance (ITC as Fixed Amount)}$$

Where the ITC basis disallowance values are from the federal depreciation table for the ITCs that reduce depreciation basis.

### Depreciable Basis after ITC Reduction

$$\text{Depreciable Basis after ITC Reduction} = \text{Depreciable Basis Prior to ITC} - \text{ITC Reduction:State} - \text{ITC Reduction:Federal}$$

## Bonus Depreciation

For each depreciation class that qualifies for bonus depreciation as indicated by the check boxes under Bonus Depreciation on the [Depreciation](#) page, bonus depreciation percentage applies to the depreciable basis.

**Note.** The bonus depreciation percentage applies to the depreciation basis for state taxes only when **State** under **Bonus Depreciation** is checked. Similarly, the bonus depreciation percentage applies for federal taxes only when **Federal** under **Reduces Depreciation Basis** is checked.

### First Year Bonus Depreciation

For each depreciation class with **Bonus Depreciation** checked on the Depreciation page:

$$\text{First Year Bonus Depreciation} = \text{Depreciable Basis after ITC Reduction} \times \text{Bonus Depreciation Percentage}$$

Where Bonus Depreciation Percentage is from the Depreciation page: The state bonus percentage applies to the state depreciation table, and the federal percentage applies to the federal depreciation table.

## Depreciable Basis

The depreciable basis after IBI, CBI, ITC and bonus depreciation reduction is the basis to which the depreciation percentages defined by the depreciation class apply.

$$\text{Depreciable Basis after Bonus Reduction} = \text{Depreciable Basis after ITC Reduction} - \text{First Year Bonus Depreciation}$$

The following table shows the depreciation percentage by year for each depreciation class. For each depreciation class, the percentage is applied to the depreciable basis amount for the given year in the cash flow:

Years 1-10	1	2	3	4	5	6	7	8	9	10
5-yr MACRS	20.0	32.0	19.2	11.5	11.5	5.8				
15-yr MACRS	5.0	9.5	8.6	7.7	6.9	6.2	5.9	5.9	5.9	5.9
5-yr SL	10.0	20.0	20.0	20.0	20.0	10.0				
15-yr SL	3.3	6.7	6.7	6.7	6.7	6.7	6.7	6.7	6.7	6.7
20-yr SL	2.5	5.0	5.0	5.0	5.0	5.0	5.0	5.0	5.0	5.0
39-yr SL	1.3	2.6	2.6	2.6	2.6	2.6	2.6	2.6	2.6	2.6
Years 11-20	11	12	13	14	15	16	17	18	19	20
15-yr MACRS	5.9	5.9	5.9	5.9	5.9	3.0				
15-yr SL	6.7	6.7	6.7	6.7	6.7	3.3				
20-yr SL	5.0	5.0	5.0	5.0	5.0	5.0	5.0	5.0	5.0	5.0
39-yr SL	2.6	2.6	2.6	2.6	2.6	2.6	2.6	2.6	2.6	2.6
Years 21-30	21	22	23	24	25	26	27	28	29	30
20-yr SL	2.5									
39-yr SL	2.6	2.6	2.6	2.6	2.6	2.6	2.6	2.6	2.6	2.6
Years 31-40	31	32	33	34	35	36	37	38	39	40
39-yr SL	2.6	2.6	2.6	2.6	2.6	2.6	2.6	2.6	2.6	1.3

## 34.5 Sale Leaseback

This topic describes the [cash flow](#) table generated by the financial model for the Sale Leaseback financial model. See [Financial Models](#) for details.

SAM offers three options for exporting cash flow data:

- **Copy to clipboard** copies the table to your clipboard. You can paste the entire table into a word processing document, spreadsheet, presentation or other software.
- **Save as CSV** saves the table in a comma-delimited text file that you can open in a spreadsheet program or text editor.
- **Send to Excel** (Windows only) creates an Excel workbook that contains the data from the cash flow, but no formulas.
- **Send to Excel with Equations** (Windows only) exports the cash flow data to an existing Excel workbook that contains formulas to illustrate how SAM's internal cash flow calculations work. The workbooks are in the `runtime\spreadsheets` folder of your [SAM installation folder](#).

**Notes.**

SAM makes cash flow calculations internally during the simulation. It does not use Excel to make the calculations. The two **Send to Excel** options are to help you analyze the cash flow data and understand how SAM's internal calculations work.

You can also display cash flow data by building a [data](#) table.

## Production

### Energy Values for Financial Models Except Single Owner

#### Energy, kWh

For systems that generate electricity, the total amount of electricity generated by the system in AC kilowatt-hours for each year.

For solar water heating systems, the total amount of electricity saved by the solar water heating system in AC kilowatt-hours for each year.

### Energy Values for the Single Owner Financial Model

#### Energy to grid, kWh

Total AC electricity delivered to the grid by the power system in each year of the analysis period, including electricity from battery storage if applicable.

This value is the sum of the hourly or subhourly Electricity to grid values.

#### Energy from grid, kWh

Total grid AC electricity consumed by the power system in each year to meet loads for inverter night-time consumption, battery charging, and freeze protection and other parasitic loads for concentrating power systems.

This value is the sum of hourly or subhourly Electricity from grid values.

#### Net energy to grid, kWh

The total net AC electricity delivered to the grid by the power system in each year of the analysis period. For projects with a fixed power price, this is the value used to determine project revenue. For projects with time-of-delivery (TOD) power price multipliers, the revenue is calculated on a time-step basis.

## Energy and Degradation

For Year One of the project cash flow, the energy values are calculated the performance model

$$\text{Energy in Year One} = \text{Sum of Hourly or Sub-hourly Values}$$

Where Sum of Hourly or Sub-hourly Values is the system's total annual electrical output (or energy saved), equal to the sum of the values calculated by the performance model (8,760 values for hourly simulations).

For Years 2 and later:

$$\text{Energy in Year } n > 1 = \text{Energy in Year } n-1 \times (1 - \text{degradation rate})$$

Where Energy in Year n-1 is the previous year's energy value and degradation rate is from the [Lifetime](#) page.

**Note.** If you specified **degradation rate** on the [Lifetime](#) page using the [annual schedule](#) option, SAM applies the value as follows:

$$\text{Energy in Year } n > 1 = \text{Energy in Year 1} \times (1 - \text{degradation rate} \div 100\%)$$

## Revenue

### PPA price (cents/kWh)

The PPA price in Year One is either the value you specify on the [Financial Parameters](#) page, or the value calculated by SAM to meet the IRR target you specify on the Financial Parameters page. The PPA price in Year One is the PPA price:

$$\text{PPA Price in Year One} = \text{Adjusted PPA Price}$$

For analyses that do not involve time-dependent pricing, *Adjusted PPA Price* is equal to the [PPA Price](#) reported on the [Metrics table](#).

For analyses that do involve time-dependent pricing, for each hour of the year, SAM multiplies the [PPA price](#) shown in the [Metrics table](#) (equivalent to the bid price) by the TOD factor for that hour to calculate a set of hourly energy prices for Year one. The *Adjusted PPA Price* is the average of the 8,760 hourly values.

### Notes.

When you choose **Specify PPA Price** for **Solution Mode** on the Financial Parameters page, the [PPA Price](#) in the [Metrics table](#) is equal to the price you specify. When you choose **Specify IRR Target**, SAM calculates the PPA price required to meet the IRR target that you specify.

The TOD factors are on the Thermal Energy Storage page for CSP systems (parabolic trough, power tower, linear Fresnel, generic solar system), and on the [Revenue](#) page for photovoltaic and other systems.

To remove time-dependent pricing from your analysis, set the TOD factor for each of the 9 periods to one. Where Adjusted [PPA Price](#) is either the value you specify on the Financial Parameters page, or a value calculated to cover project costs based on the target IRR you specify on the [Financial Parameters](#) page, adjusted by the time-of-delivery (TOD) factors.

In Years Two and later:

$$\text{PPA Price in Year } n > 1 = \text{PPA Price in Year } n-1 \times (1 + \text{PPA Escalation Rate})^{(n-1)}$$

Where *PPA Escalation Rate* is from the [Financial Parameters](#) page.

**Note.** SAM uses the PPA Price to calculate the [levelized cost of energy](#).

## Revenue for PPA Single Owner Financial Model

The Single Owner financial model reports three revenue values in the project cash flow.

### PPA revenue gross

The gross project revenue earned from electricity sales. For a project with a PPA price that does not vary with time of delivery, this is the net annual energy to grid in kWh multiplied by the PPA price in \$/kWh.

**PPA revenue lost to self-consumption**

Revenue lost to grid power purchases to meet power system self-consumption loads such as inverter nighttime power consumption for photovoltaic systems, and freeze protection power and other parasitic loads for concentrating power systems.

For systems for battery storage, when the option on the [Electricity Rates](#) page is **No Electricity Rate**, revenue lost to self-consumption also includes power for battery charging.

**PPA revenue net**

The net revenue earned from electricity sales, accounting for revenue lost do self-consumption.

**Revenue for PPA Partnership and Sale Leaseback Models****PPA revenue to project**

The project's annual revenue from electricity sales, not accounting for salvage value:

$$\text{Total PPA Revenue} = \text{Net Energy (kWh)} \times \text{PPA Price (cents/kWh)} \times 0.01 (\$/cents)$$

**Salvage value**

SAM calculates the net salvage value using the percentage you specify on the [Financial Parameters](#) page and the total installed cost from the System Costs page. The salvage value applies in the final year of the project cash flow.

For example, if you specify a 10% salvage value for a project with a 30-year analysis period, and total installed cost of \$1 million, SAM includes income in Year 30 of  $\$100,000 = \$1,000,000 \times 0.10$ .

SAM adds the salvage value as income (a negative value) to the operating expenses in the cash flow in the final year of the analysis period. The salvage value therefore reduces the operating expenses in the final year of the analysis period.

For residential projects, the salvage value has no effect on federal and state income tax because operating expenses are not taxable.

For commercial projects, because the salvage value reduces the operating expenses in the final year of the analysis period, it increases the federal and state income tax payment because operating expenses are deductible from federal and state income tax.

**Total revenue to project**

The projects annual revenue, accounting for salvage value.

$$\text{Total Revenue} = \text{Total PPA Revenue} + \text{Salvage Value}$$

Because Salvage Value is zero for all years except the last year of the analysis period, the Total Revenue and Total PPA Revenue are the same for all years except for the last year.

For the Single Owner and Leveraged Partnership Flip financial models (both of which include debt), total revenue may also include production-based [incentive](#) (PBI) amounts. For each PBI amount that you check on the [Financial Parameters](#) page under **Debt Service, Production Based Incentives (PBI) Available for Debt Service**, SAM displays a row for the PBI above the Total Revenue row, and includes the amount in the Total Revenue amount:

$$\text{Total Revenue} = \text{Total PPA Revenue} + \text{Salvage Value} + \text{PBI}$$

**Expenses****O&M Fixed expense**

$$\text{O\&M Fixed Expense in Year } n = \text{Fixed Annual Cost (\$)} \times (1 + \text{Inflation Rate} + \text{Escalation Rate}) ^ n$$

1

Where *Fixed Annual Cost* is from the [System Costs](#) page, and *Inflation Rate* and *Escalation Rate* are from the [Financial Parameters](#) page.

**O&M Capacity-based expense**

$$O\&M \text{ Capacity-based Expense in Year } n = \text{Fixed Cost by Capacity } (\$/kW\text{-yr}) \times \text{System Rated Capacity} \times (1 + \text{Inflation Rate} + \text{Escalation Rate})^{(n-1)}$$

Where *Fixed Cost by Capacity* is from the [System Costs](#) page, and *Inflation Rate* and *Escalation Rate* are from the [Financial Parameters](#) page.

The system nameplate capacity depends on technology being modeled. SAM converts the capacity value to the appropriate units (MW, kW, or W) before using it in calculations. For the photovoltaic models, the capacity is a DC power rating, and for the others it is an AC power rating. For the Solar Water Heating Model, the capacity is a thermal rating, while for the others it is an electric rating.

**Table 21. Nameplate system capacity values for each technology.**

Performance Model	System Capacity	Input Page
Detailed photovoltaic (DC)	Total Array Power (Wdc)	<a href="#">Array</a>
PVWatts (DC)	DC Rating (kWdc)	<a href="#">PVWatts Solar Array</a>
High concentration photovoltaic (DC)	System Nameplate Capacity	<a href="#">Array</a>
CSP Parabolic Trough - Physical (AC)	Estimated Net Output at Design (Nameplate) (MWe)	<a href="#">Power Cycle</a>
CSP Parabolic Trough - Empirical (AC)	Estimated Net Output at Design (MWe)	<a href="#">Power Block</a>
CSP Molten Salt Power Tower (AC)	Estimated Net Output at Design (Nameplate) (MWe)	<a href="#">Power Cycle</a>
CSP Generic Solar (AC)	Estimated Net Output at Design (Nameplate) (MWe)	<a href="#">Power Block</a>
CSP Linear Fresnel (AC)	Net nameplate capacity (MWe)	<a href="#">Power Cycle</a>
Generic System (AC)	Nameplate Capacity (kWe)	<a href="#">Power Plant</a>
Geothermal	Net Plant Output (MWe)	<a href="#">Plant and Equipment</a>
Water Heating Model (Thermal)	Nameplate Capacity (kWt)	<a href="#">SWH System</a>
Wind Power (AC)	System Nameplate Capacity (kWe)	<a href="#">Wind Farm</a>
Biopower (AC)	Nameplate Capacity, Gross (kWe)	<a href="#">Plant Specs</a>

**O&M Production-based expense**

$$O\&M \text{ Production-based Expense in Year } n = \text{Variable Cost by Generation } (\$/MWh) \times \text{Net Energy in Year } n \text{ (MWh)} \times (1 + \text{Inflation Rate} + \text{Escalation Rate})^{(n-1)}$$

Where *Variable Cost by Generation* is from the [System Costs](#) page, *Net Energy* is described above,



and *Inflation Rate* and *Escalation Rate* are from the [Financial Parameters](#) page.

### O&M Fuel expense

The following performance models include a fuel cost calculation:

- Parabolic trough ([physical](#) or [empirical](#)) with fossil backup
- [Power tower](#) with fossil backup
- [Generic solar](#) system with fossil backup
- [Generic system](#) for the primary fuel cost
- [Biomass Power](#) for biomass and supplementary coal feedstock costs

**Note.** For the CSP systems listed above, SAM only considers the system to have a fossil-fired backup boiler when the fossil fill fraction variable on the Thermal Storage page is greater than zero.

For solar and generic systems listed above that consume a fuel, Fuel O&M is the annual fuel cost:

$$\text{Fuel O\&M in Year } n = \text{Annual Fuel Usage in Year One (kWh)} \times 0.003413 \text{ MMBtu per kWh} \times \text{Fossil Fuel Cost (\$/MMBtu)} \times (1 + \text{Inflation Rate} + \text{Escalation Rate})^{(n-1)}$$

Where *Annual Fuel Usage in Year One* is the quantity of fuel consumed in Year One calculated by the performance model. *Fossil Fuel Cost* and *Escalation Rate* are from the [System Costs](#) page, and *Inflation Rate* is from the [Financial Parameters](#) page.

**Note.** When you specify fuel costs using an annual schedule instead of a single value, SAM does not apply the inflation rate or escalation rate to the values you specify for each year.

For the [biomass power](#) model, SAM calculates feedstock and coal costs using feedstock usage and price values from the [Feedstock Costs](#) page:

$$\text{Biomass Feedstock Costs in Year } n = \text{Total Biomass Fuel Usage in Year One (dry tons/year)} \times \text{Biomass Fuel Cost (\$/dry ton)} \times (1 + \text{Inflation Rate} + \text{Escalation Rate})^{(n-1)}$$

$$\text{Coal Feedstock Costs in Year } n = \text{Total Coal Fuel Usage in Year One (dry tons/year)} \times \text{Coal Fuel Cost (\$/dry ton)} \times (1 + \text{Inflation Rate} + \text{Escalation Rate})^{(n-1)}$$

Where the fuel usage and fuel costs are from the [Feedstock Costs](#) page, and *Inflation Rate* and *Escalation Rate* are from the [Financial Parameters](#) page.

### Insurance expense

The insurance cost applies in Year One and later of the cash flow:

$$\text{Insurance in Year } n = \text{Total Installed Costs (\$)} \times \text{Insurance (\%)} \times (1 + \text{Inflation Rate})^{(n-1)}$$

Where *Total Installed Costs* is the value from the [System Costs](#) page, and *Insurance* and *Inflation Rate* are specified on the [Financial Parameters](#) page.

### Property tax net assessed value

The property assessed value is the value SAM uses as a basis to calculate the annual property tax payment:

$$\text{Property Assessed Value in Year One} = \text{Assessed Value}$$

Where *Assessed Value* is from the [Financial Parameters](#) page.

In Years 2 and later, the property assessed value is the Year One value adjusted by the assessed value decline value from the [Financial Parameters](#) page:

$$\text{Property Assessed Value in Year } n > 1 = \text{Assessed Value in Year One} \times [1 - \text{Assessed Value Decline} \times (n-1)]$$

Where *Assessed Value Decline* is from the Financial Parameters page, expressed as a fraction instead of a percentage.

If the value of  $1 - \text{Assessed Value Decline} \times (n-1)$  for a given year is equal to zero or less, then the *Property Assessed Value* in that year is zero.

### Property tax expense

Property taxes apply in Year One and later of the cash flow:

$$\text{Property Taxes in Year } n = \text{Property Assessed Value in Year } n (\$) \times \text{Property Tax } (\%)$$

Where *Property Assessed Value* is described above, and *Property Tax* is from the [Financial Parameters](#) page.

### Annual Developer (Lessee LLC) Margin (Sale Leaseback only)

$$\text{Annual Developer Margin in Year } n = \text{Developer Operating Margin} \times (1 + \text{Developer Margin Escalation})^{(n-1)}$$

Where *Developer Operating Margin* and *Developer Margin Escalation* are from the [Financing](#) page.

### Total operating expense

The total operating expense is the sum of expenses:

$$\text{Total Operating Expense in Year } n = \text{O\&M Fixed Expense} + \text{O\&M Capacity-based Expense} + \text{O\&M Production-based Expense} + \text{O\&M Fuel Expense} + \text{Insurance Expense} + \text{Property Tax Expense}$$

## Operating Margin Not Including Lease Payment

$$\text{Operating Margin Not Including Lease Payment} = \text{Total Revenue} - \text{Total Operating Expense}$$

## Cash Flow: Developer (Lessee LLC)

### Cash Flows from Operating Activities

The developer's cash flow from operating activities includes revenue less operating expenses plus interest earned on reserves.

#### Operating Margin Not Including Lease Payment

See above.

#### Plus Interest Earned

Interest earned on reserves

$$\text{Plus Interest Earned} = \text{Total Reserves in Year } n \times \text{Interest on Reserves}$$

Where *Interest on Reserves* is from the [Financial Parameters](#) page and *Total Reserves in Year n* is the sum of capital reserve and the up to three major equipment reserve ending balances in Year n:

$$\text{Total Reserves} = \text{Working Capital Reserve Ending Balance} + \text{Total Major Equipment Reserve Ending Balance}$$

#### Total

The total cash flow from operating reserves is the sum of operating margin and interest earned on reserves:

*Total in Year n = Operating Margin Not Including Lease Payment + Plus Interest Earned*

## Developer Cash Flows from Investing Activities

The developer's cash flow from investing activities occurs in Year Zero, except for the salvage value adjustment which is in the final year of the cash flow.

### Sale of Property

*Sale of Property in Year Zero = Total Construction Financing Cost + Development Fee + Equity Closing Cost + Other Financing Cost + Total Installed Costs*

Where *Total Construction Financing Cost*, *Development Fee*, *Equity Closing Cost*, and *Other Financing Cost* are from the [Financial Parameters](#) page, and *Total Installed Costs* is from the [System Costs](#) page.

### Purchase of Plant

*Purchase of Plant in Year Zero = Total Installed Cost - Equity Closing Cost - Total Construction Financing*

Where *Total Construction Financing Cost*, and *Equity Closing Cost* are from the [Financial Parameters](#) page, and *Total Installed Costs* is from the [System Costs](#) page.

### Distribution of Development Fee

*Distribution of Development Fee in Year 0 = Development Fee*

Where Development fee is from the [Financial Parameters](#) page.

### Adjustment for Salvage Value

*Adjustment for Salvage value in Final Year = - Salvage Value*

Where *Salvage Value* is described above under Partial Income Statement: Project.

### (Increase)/Decrease in working capital reserve account

The working capital reserve amount in Year Zero depends on the Months of Operating Costs from the [Financial Parameters](#) page and the Year One total operating expense:

*Capital Reserve in Year Zero = Total Operating Expense in Year One (\$) × Months of Operating Costs (months) ÷ 12 (months)*

In Year One and later:

*Capital Reserve in Year n>0 = Capital Reserve in Year n-1 (\$) - Total Operating Expense in Year n (\$) × Months of Operating Costs (months) ÷ 12 (months)*

Where *Months of Operating Costs* is from the [Financial Parameters](#) page.

### (Increase)/Decrease in major equipment reserve accounts

For each of the up to three major equipment reserve accounts that you specify on the [Financial Parameters](#) page, SAM calculates the annual amount required to ensure that sufficient funds are available in the replacement year to cover the replacement cost:

For example, in the example described below under Major Equipment Capital Spending, the annual increase in reserves is \$530,682/year = \$2,653,400 ÷ 5 years.

*Increase in Major Equipment Reserve = Inflation Adjusted Replacement Cost in Replacement Year (\$) ÷ Replacement Year (year)*

The increase is shown in the cash flow as a negative value.

In the year that the replacement occurs (in this example, Year 5), the decrease in major equipment reserve account is \$2,122,727 = \$2,653,400 - \$430,682.

*Decrease in Major Equipment Reserve in Replacement Year = Inflation Adjusted Replacement Cost in Replacement Year - Increase in Major Equipment Reserve*

The decrease is shown in the cash flow as a positive value.

#### **(Increase)/Decrease in reserve accounts**

*Increase in reserve accounts = Lease Payment Reserve + Working Capital Reserve + Total Major Equipment Reserves*

Where the reserve amounts are described below under Reserve Accounts.

#### **Major equipment capital spending**

For each of the up to three major equipment reserve accounts that you specify on the [Financial Parameters](#) page, the inflation-adjusted amount is reported in the year that you specify.

For example, if you specify a \$2,500 (in Year One dollars) replacement cost with a 5 year replacement frequency, and an inflation rate of 1.5% on the Financial Parameters page, SAM reports a major equipment capital spending amounts in years 5, 10, 15 etc. For Year 5, the amount would be \$2,653,400 = \$2,500,000 × (1 + 0.015)<sup>4</sup>.

In each year that the replacement occurs:

*Capital Spending = - Replacement Cost (Year One \$) × (1 + Inflation Rate)<sup>(Replacement Year - 1)</sup>*

The value is negative because it represents an expense or outflow.

#### **Total**

The total developer cash flows from investing activities is the sum of purchase property cost, reserve account deposits or withdrawals, and capital spending:

*Total in Year Zero = Sale of Property + Purchase of Plant + Distribution and Development Fee + Working Capital Reserve Account + Lease Payment Reserve + Major Equipment Reserve Account*

*Total in Year n>0 = Major Equipment Reserve Account + Major Equipment Capital Spending*

### **Developer Cash Flows from Financing Activities**

**Developer Equity in Lessee LLC (funding of reserve accounts)**

**Total**

**Pre-tax cash flow including release of reserves**

**Adjustment for release of reserves**

### **Developer Pre-tax operating cash flow (effective lease payment)**

### **Cash Flow: Tax Investor (Lessor)**

#### **Tax Investor Cash Flows from Operating Activities**

**Lease Payment**

**Total**

#### **Tax Investor Cash Flows from Investing Activities**

Purchase of Property  
 Pre-Tax Salvage Value  
 Total

### Tax Investor Cash Flows from Financing Activities

Issuance of equity  
 IBI  
 CBI  
 Total

### Tax Investor Pre-tax Cash Flow

### LCOE

SAM reports quantities used in the LCOE calculation in the cash flow table for reference. For a description of the LCOE see [Levelized Cost of Energy \(LCOE\)](#).

#### Total PPA revenue

The total PPA revenue is the project's annual revenue from electricity sales, not accounting for salvage value:

$$\text{Total PPA Revenue} = \text{Net Energy (kWh)} \times \text{PPA Price (cents/kWh)} \div 100 \text{ (cents/\$)}$$

#### Net Energy (kWh)

The total amount of electricity generated by the system in AC kilowatt-hours for each year. See description above

#### NPV of PPA revenue

The present value of the annual PPA revenue streams over the analysis period used as the numerator of the LCOE equation:

$$\text{NPV(Revenue)} = \sum_{n=0}^N \frac{R_{PPA,n}}{(1 + d_{nominal})^n}$$

Where  $R_{PPA,n}$  is the revenue from electricity sales-tax cash flow described above, and  $d_{nominal}$  is the nominal discount rate from the [Financial Parameters](#) page.

#### NPV of net annual energy (nominal)

The LCOE calculation requires a discounted energy term in the denominator. The value discounted using the nominal discount rate is for the nominal LCOE equation.

$$\text{NPV(Energy Nominal)} = \sum_{n=0}^N \frac{Q_n}{(1 + d_{nominal})^n}$$

Where  $Q_n$  is the annual energy value described above, and  $d_{nominal}$  is the nominal discount rate from the [Financial Parameters](#) page.

#### Nominal LCOE

$$\text{Nominal LCOE} = \text{NPV (Revenue)} / \text{NPV(Energy Nominal)}$$

**NPV of net annual energy (real)**

The LCOE calculation requires a discounted energy term in the denominator. The value discounted using the real discount rate is for the real LCOE equation.

$$NPV(\text{Energy Real}) = \sum_{n=0}^N \frac{Q_n}{(1 + d_{real})^n}$$

Where  $Q_n$  is the annual energy value described above, and  $d_{real}$  is the nominal discount rate from the [Financial Parameters](#) page.

**Real LCOE**

$$\text{Real LCOE} = NPV(\text{Revenue}) / NPV(\text{Energy Real})$$

**Party Returns****Tax Investor (Lessor) Pre-tax**

Purchase price of asset

IBI income

CBI income

Pre-tax salvage value

Lease payments

Pre-tax Total

Cumulative IRR

Cumulative NPV

**Tax Investor (Lessor) After-tax**

---

Purchase price of asset  
IBI income  
CBI income  
Pre-tax salvage value  
Lease payments  
Share of project cash total  
ITC  
PTC  
Share of project tax benefit/liability  
After-tax total  
Cumulative IRR  
Cumulative NPV  
Maximum IRR  
Total  
Cumulative IRR  
Cumulative NPV

**Developer Pre-tax**

Developer equity in Lessee LLC (funding of reserve accounts)  
Distribution of development fee  
Release of major equipment replacement reserves  
Release of working capital reserves  
Release of lease payment reserve  
Interest earned on lease payment reserve  
Developer (Lessee LLC) operating margin  
Total  
Cumulative IRR  
Cumulative NPV  
IRR  
NPV

**Developer After-tax**

Developer equity in Lessee LLC (funding of reserve accounts)  
 Distribution of development fee  
 Release of major equipment replacement reserves  
 Release of working capital reserve  
 Release of lease payment reserve  
 Interest earned on lease payment reserve  
 Developer (Lessee LLC) operating margin  
 Share of project cash  
 Share of project tax benefit/liability  
 Developer fee tax liability  
 Total  
 Cumulative IRR  
 Cumulative NPV  
 IRR  
 NPV

## Incentives

The incentive cash flow rows show the value of cash incentives and tax credits, which are used to calculate cash flows described above.

### IBI (Investment Based Incentives)

Each IBI (federal, state, utility, other) applies in Year Zero of the project cash flow.

Because you can specify each IBI on the [Incentives](#) page as either an amount or a percentage, SAM calculates the value of each IBI as the sum of two values:

$$IBI \text{ as Amount} = \text{Amount}$$

$$IBI \text{ as Percentage} = \text{Total Installed Cost (\$)} \times \text{Percentage (\%)}, \text{ up to Maximum}$$

$$IBI \text{ in Year } 0 = IBI \text{ as Amount} + IBI \text{ as Percentage}$$

Where *Amount*, *Percentage* and *Maximum* are the values that you specify on the [Incentives](#) page, and *Total Installed Cost* is from the [System Costs](#) page.

*Total IBI* is the sum of the four IBI values (federal, state, utility, other).

**Note.** The IBI amount reduces the after tax cost flow in Year Zero, and the debt balance in Year One. This is because SAM assumes that debt payments begin in Year One, when the project is generating or saving electricity.

### CBI (Capacity Based Incentives)

Each CBI (federal, state, utility, other) applies in Year Zero of the project cash flow:

$$CBI \text{ in Year } 0 = \text{System Capacity (W)} \times \text{Amount (\$/W)}, \text{ up to Maximum}$$

Where *System Capacity* is the rated capacity of the system, and *Amount* and *Maximum* are the values you specify on the [Incentives](#) page.

*Total CBI* is the sum of the four CBI values (federal, state, utility, other).



The system nameplate capacity depends on technology being modeled. SAM converts the capacity value to the appropriate units (MW, kW, or W) before using it in calculations. For the photovoltaic models, the capacity is a DC power rating, and for the others it is an AC power rating. For the Solar Water Heating Model, the capacity is a thermal rating, while for the others it is an electric rating.

**Table 22. Nameplate system capacity values for each technology.**

Performance Model	System Capacity	Input Page
Detailed photovoltaic (DC)	Total Array Power (Wdc)	<a href="#">Array</a>
PVWatts (DC)	DC Rating (kWdc)	<a href="#">PVWatts Solar Array</a>
High concentration photovoltaic (DC)	System Nameplate Capacity	<a href="#">Array</a>
CSP Parabolic Trough - Physical (AC)	Estimated Net Output at Design (Nameplate) (MWe)	<a href="#">Power Cycle</a>
CSP Parabolic Trough - Empirical (AC)	Estimated Net Output at Design (MWe)	<a href="#">Power Block</a>
CSP Molten Salt Power Tower (AC)	Estimated Net Output at Design (Nameplate) (MWe)	<a href="#">Power Cycle</a>
CSP Generic Solar (AC)	Estimated Net Output at Design (Nameplate) (MWe)	<a href="#">Power Block</a>
CSP Linear Fresnel (AC)	Net nameplate capacity (MWe)	<a href="#">Power Cycle</a>
Generic System (AC)	Nameplate Capacity (kWe)	<a href="#">Power Plant</a>
Geothermal	Net Plant Output (MWe)	<a href="#">Plant and Equipment</a>
Water Heating Model (Thermal)	Nameplate Capacity (kWt)	<a href="#">SWH System</a>
Wind Power (AC)	System Nameplate Capacity (kWe)	<a href="#">Wind Farm</a>
Biopower (AC)	Nameplate Capacity, Gross (kWe)	<a href="#">Plant Specs</a>

### PBI (Performance Based Incentive)

Each PBI (federal, state, utility, other) applies in Years One and later of the project cash flow, up to the number of years you specify:

$$PBI \text{ in Year } n = \text{Amount } (\$/kWh) \times \text{Energy in Year } n \text{ (kWh)} \times (1 + \text{Escalation})^{(n-1)}, \text{ up to Term}$$

Where *Amount*, *Term*, and *Escalation* are the values you specify on the [Incentives](#) page, and *Energy* is the value displayed in Energy row of the cash flow table (described above).

**Note.** If you use an annual schedule to specify year-by-year PBI amounts, SAM ignores the escalation rate.

*Total PBI* is the sum of the four PBI amounts (federal, state, utility, other).

**Important Note!** If you specify a PBI amount on the Cash Incentives page, be sure to also specify the incentive term. If you specify a term of zero, the incentive will not appear in the cash flow table.

### PTC (Production Tax Credit)

The state and federal PTC each apply in Year One and later of the project cash flow, up to the number of years you specify:

$$PTC \text{ in Year } n = \text{Amount } (\$/kWh) \times (1 + \text{Escalation})^{(n-1)} \times \text{Energy in Year } n \text{ (kWh)}$$

Where *Amount*, *Term*, and *Escalation* are the values you specify on the [Incentives](#) page, and *Energy* is the value displayed in the Energy row of the cash flow table (described above).

SAM rounds the product  $\text{Amount } (\$/kWh) \times (1 + \text{Escalation})^{(n-1)}$  to the nearest multiple of 0.1 cent as described in Notice 2010-37 of [IRS Bulletin 2010-18](#).

**Note.** If you specify year-by-year PTC rates on the Incentives page using an Annual Schedule instead of a single value, SAM ignores the PTC escalation rate.

### ITC (Investment Tax Credit)

The state and federal ITC each apply only in Year One of the project cash flow. For ITCs that you specify as a fixed amount:

$$ITC \text{ in Year One} = \text{Amount}$$

Where *Amount* is the value you specify in the [Incentives](#) page.

For ITCs that you specify as a percentage of total installed costs:

$$ITC \text{ in Year One} = ( \text{Total Installed Cost } (\$) - \text{ITC Basis Reduction } (\$) ) \times \text{Percentage } (\%), \text{ up to Maximum}$$

Where *Total Installed Cost* is from the [System Costs](#) page, and *Percentage* and *Maximum* are the values you specify on the [Incentives](#) page.

*ITC Basis Reduction* applies only to the Commercial and PPA financial models, and depends on whether the project includes any investment-based incentives (IBI) or capacity-based incentives (CBI) specified on the [Incentives](#) page with checked boxes under **Reduces Depreciation and ITC Bases**. For each IBI or CBI with a check mark, SAM subtracts the incentive amount from the total installed cost to calculate the ITC.

$$ITC \text{ Basis Reduction} = IBI + CBI$$

Where *IBI* and *CBI* are the incentives that you have specified reduce the ITC basis on the [Incentives](#) page.

## Reserve Accounts

Reserve accounts include debt service, working capital reserve, and major equipment replacement reserves. The reserve account amounts depend on the following inputs from the Financial Parameters page:

- Inflation Rate
- Debt Service Reserve Account (months P&I)
- Working Capital Reserve Months of Operating Costs
- Major Equipment Replacement Reserve Account [1-3] Frequency (years)
- Major Equipment Replacement [1-3] (Year 1 \$)

**Lease Payment Reserve (Sale Leaseback only)**

$$\text{Lease Payment Reserve} = \text{Tax Investor (Lessor) Required Lease Payment Reserve (months)} \div 12 \times \text{Total Developer Pre-tax Cash Flow from Operating Activities in Year } n+1$$

**Debt Service Reserve**

The debt service reserve applies in Year Zero and later:

$$\text{Debt Service Reserve} = \text{Debt Service Reserve Account (months P\&I)} \div 12 \times \text{Total P\&I in Year } n+1$$

Where *Debt Service Reserve Account (months P&I)* is from the Financial Parameters page, and *Total P&I in Year n+1* is described under Debt above.

**Working Capital Reserve**

Working capital reserve applies in Year Zero and later:

$$\text{Working Capital Reserve} = \text{Months of Operating Costs} \times \text{Operating Expenses in Year } n+1$$

Where *Months of Operating Costs* is from the Financial Parameters page, and *Operating Expenses in Year n+1* is described above.

**Major Equipment Replacement Reserves**

You can specify up to three major equipment reserve accounts on the Financial Parameters page. For each account, the amount applies in Year One and later of the cash flow:

$$\text{Major Equipment Reserve in Year } n = \text{Major Equipment Reserve in Year } n-1 + \text{Funding} + \text{Release of Funds}$$

Where Major Equipment Reserve in Year Zero = 0, and:

$$\text{Funding} = \text{Release of Funds in Year of Next Replacement} \div \text{Replacement Frequency}$$

$$\text{Release of Funds in Year of Next Replacement} = - \text{Replacement Cost in Year One } \$ \times (1 + \text{Inflation Rate})^{(n-1)}$$

Where *Replacement Frequency*, *Replacement Cost in Year One \$*, and *Inflation Rate* are from the Financial Parameters page

**Depreciation and ITC**

The federal and state Depreciation and ITC tables show the depreciable basis calculation for each of the up to seven depreciation classes for federal and state tax purposes:

- The total depreciable amount includes the total installed cost, development fee, equity closing cost, debt service reserve, working capital reserve, and for the Sale Leaseback financial model, the lease payment reserve.
- The depreciation class allocations on the [Financial Parameters](#) page determine how the depreciable basis is allocated to the different depreciation classes (MACRS 5-yr, Straight Line, etc.).
- For each state and federal IBI and CBI with **Reduces Depreciation and ITC Bases** checked on the [Incentives](#) page, the full incentive amount reduces the depreciable basis.
- For each state and federal ITC with **Reduces Depreciation Basis** checked on the [Incentives](#) page, 50% of the tax credit amount reduces the depreciable basis.
- For each depreciation class with a checked box under **Bonus Depreciation** on the Financial Parameters page, the depreciable basis is the product of the bonus depreciation percentage and the adjusted depreciable basis. (The adjusted depreciable basis is the total depreciable after incentives and tax credit adjustments.)

- For state and federal taxes, depreciation for major equipment replacement reserves uses the class specified on the Financial Parameters page.

The depreciation amounts depend on the total installed cost from the [System Costs](#) page, and the following inputs from other pages.

From the Financial Parameters page:

- Development Fee
- Debt Closing Costs
- Debt Closing Fee
- Equity Closing Cost
- Construction Financing
- Other Financing Cost

From the [Incentives](#) page:

- State ITC as Percentage
- State ITC Maximum
- State ITC as Amount
- Federal ITC as Percentage
- Federal ITC Maximum
- Federal ITC as Amount
- Status of **Reduces Depreciation Basis** check boxes
- The amounts and percentages of any incentive with **Reduces Depreciation and ITC Bases** checked

From the [Depreciation](#) page:

- Allocations for each depreciation class
- Bonus depreciation amounts and applicable depreciation classes
- ITC qualification status of depreciation classes

The depreciation amounts also depend on the following cash flow values:

- Debt service reserve
- Working capital reserve
- IBI (only for incentives shown to reduce depreciation basis on Incentives page)
- CBI (only for incentives shown to reduce depreciation basis on Incentives page)
- Debt funding
- For state depreciation, the federal ITC basis disallowance amounts for each depreciation class
- For federal depreciation, the state ITC basis disallowance amounts for each depreciation class

### Gross Depreciable Basis with IBI and CBI Reductions Before ITC Reductions

For each depreciable class, the depreciable basis before reduction by the ITC is the gross depreciable basis less IBI and CBI amounts for incentives on the Cash Incentives page with **Reduces Depreciation and ITC Bases** checked.

**Note.** The IBI and CBI reduce the depreciation basis for state taxes only when **State** under **Reduces Depreciation and ITC Bases** is checked. Similarly, the IBI and CBI reduce the depreciation basis for federal taxes only when **Federal** under **Reduces Depreciation and ITC Bases**.

**% of Total Depreciable Basis**

The normalized allocation for each depreciation class allocation:

$$\% \text{ of Total Depreciable Basis} = \text{Allocation} \div \text{Sum of Allocations}$$

Where *Allocation* is the percentage for the given depreciable class, and *Sum of Allocations* is the sum of all allocations from the Financial Parameters page.

**Gross Amount Allocated**

The gross depreciable basis before reductions for each depreciation class:

$$\text{Gross Amount Allocated} = \% \text{ of Total Depreciable Basis} \times \text{Total Depreciable Amount}$$

Where % of Total Depreciable Basis is described above, and

$$\text{Total Depreciable Amount} = \text{Total Installed Cost} + \text{Development Fee} + \text{Equity Closing Cost} + \text{Debt Closing Costs} + \text{Debt Closing Fee} \times \text{Funding} + \text{Debt Service Reserve} + \text{Working Capital Reserve} + \text{Lease Payment Reserve}$$

Where *Total Installed Cost* is from the [System Costs](#) page; *Development Fee*, *Equity Closing Cost*, *Debt Closing Costs*, and *Debt Closing Fee* are from the [Financial Parameters](#) page; and *Debt Service Reserve*, *Working Capital Reserve* and *Lease Payment Reserve* (Sale Leaseback financial model only) are other values in the cash flow described above

**Reduction: IBI**

The reduction in depreciation basis from IBI payments:

$$\text{Reduction IBI} = \text{Total IBI that Reduce Depreciation} \times \% \text{ of Total Depreciable Basis}$$

Where *Total IBI that Reduce Depreciation* is the sum of IBI values in the cash flow for incentives with **Reduces Depreciation and ITC Bases** checked on the [Incentives](#) page. For the state depreciation table, **State** must be checked for the incentive to reduce the state depreciation basis. For the federal depreciation table, **Federal** must be checked. *% of Total Depreciable Basis* is the allocation for the depreciation class described above.

**Reduction: CBI**

The reduction in depreciation basis from CBI payments:

$$\text{Reduction CBI} = \text{Total CBI that Reduce Depreciation} \times \% \text{ of Total Depreciable Basis}$$

Where *Total CBI that Reduce Depreciation* is the sum of CBI values in the cash flow for incentives with **Reduces Depreciation and ITC Bases** checked on the [Incentives](#) page. For the state depreciation table, **State** must be checked for the incentive to reduce the state depreciation basis. For the federal depreciation table, **Federal** must be checked. *% of Total Depreciable Basis* is the allocation for the depreciation class described above.

**Depreciable Basis Prior to ITC**

The depreciable basis reduced by CBI and IBI amounts:

$$\text{Depreciable Basis Prior to ITC} = \text{Gross Amount Allocated} - \text{Reduction: IBI} - \text{Reduction: CBI}$$

**ITC Reduction**

For each ITC on the [Incentives](#) page with **Reduces Depreciation Basis** checked, 50% of the ITC amount can be included in the depreciable basis for each depreciable class with **ITC Qualification** checked on the [Depreciation](#) page. SAM calculates the ITC reduction amount for ITCs that you specify on the Incentives page a percentage of the total installed costs with a maximum amount, and ITCs that you specify as a fixed amount.

**Note.** The ITC reduces the depreciation basis for state taxes only when **State** under **Reduces Depreciation Basis** is checked on the [Incentives](#) page, and when **State** is checked under **ITC Qualification** for the depreciation class on the [Depreciation](#) page. Similarly, the ITC reduces the depreciation basis for federal taxes only when **Federal** is checked under **Reduces Depreciation Basis** and under **ITC Qualification** for the depreciation class.

For each ITC specified as a percentage and maximum on the Incentives page, the *ITC Basis Disallowance* is the amount that may be available for depreciation basis reduction. (The ITC Reduction amounts are the amounts actually available.):

#### **ITC Qualifying Costs**

For depreciation classes with **ITC Qualification** checked on the [Depreciation](#) page:

$$ITC\ Qualifying\ Costs = Depreciable\ Basis\ Prior\ to\ ITC$$

#### **% of ITC Qualifying Costs**

For each depreciable class:

$$\% \text{ of ITC Qualifying Costs} = ITC\ Qualifying\ Costs \div Total\ Depreciable\ Basis\ Prior\ to\ ITC$$

Where *Total Depreciable Basis Prior to ITC* is the sum of *Depreciable Basis Prior to ITC* for all depreciable classes.

#### **ITC Amount**

$$ITC\ Amount = \% \text{ of ITC Qualifying Costs} \times ITC\ Qualifying\ Costs$$

#### **ITC Basis Disallowance**

The ITC depreciation basis disallowance is 50% of the ITC amount:

$$ITC\ Basis\ Disallowance = ITC\ Amount \times 0.5$$

For each ITC specified as a fixed amount on the Incentives page, the ITC Basis Disallowance is the amount that may be available for depreciation basis reduction. (The ITC Reduction amounts are the amounts actually available.):

#### **ITC Amount**

For each depreciable class, the Total ITC Amount is the amount that may be available for depreciation reduction:

$$ITC\ Amount = Total\ ITC\ Amount \times \% \text{ of ITC Qualifying Costs}$$

Where, for the state depreciation table, *Total ITC Amount* is the state ITC amount from the [Incentives](#) page. For the federal depreciation table, *Total ITC Amount* is the federal ITC amount from the Incentives page.

#### **ITC Basis Disallowance**

The ITC depreciation basis disallowance is 50% of the ITC amount:

$$ITC\ Basis\ Disallowance = ITC\ Amount \times 0.5$$

The depreciable basis after ITC reduction is the sum of the total ITC basis disallowance values for the ITCs with **Reduces Depreciation Basis** checked on the Incentives pages.

#### **ITC Reduction: State**

$$ITC\ Reduction: State = ITC\ Basis\ Disallowance\ (ITC\ as\ \%) + ITC\ Basis\ Disallowance\ (ITC\ as\ Fixed\ Amount)$$

Where the ITC basis disallowance values are from the state depreciation table for the ITCs that reduce

depreciation basis.

### ITC Reduction: Federal

*ITC Reduction: Federal = ITC Basis Disallowance (ITC as %) + ITC Basis Disallowance (ITC as Fixed Amount)*

Where the ITC basis disallowance values are from the federal depreciation table for the ITCs that reduce depreciation basis.

### Depreciable Basis after ITC Reduction

*Depreciable Basis after ITC Reduction = Depreciable Basis Prior to ITC - ITC Reduction:State - ITC Reduction:Federal*

## Bonus Depreciation

For each depreciation class that qualifies for bonus depreciation as indicated by the check boxes under Bonus Depreciation on the [Depreciation](#) page, bonus depreciation percentage applies to the depreciable basis.

**Note.** The bonus depreciation percentage applies to the depreciation basis for state taxes only when **State** under **Bonus Depreciation** is checked. Similarly, the bonus depreciation percentage applies for federal taxes only when **Federal** under **Reduces Depreciation Basis** is checked.

### First Year Bonus Depreciation

For each depreciation class with **Bonus Depreciation** checked on the Depreciation page:

*First Year Bonus Depreciation = Depreciable Basis after ITC Reduction × Bonus Depreciation Percentage*

Where Bonus Depreciation Percentage is from the Depreciation page: The state bonus percentage applies to the state depreciation table, and the federal percentage applies to the federal depreciation table.

## Depreciable Basis

The depreciable basis after IBI, CBI, ITC and bonus depreciation reduction is the basis to which the depreciation percentages defined by the depreciation class apply.

*Depreciable Basis after Bonus Reduction = Depreciable Basis after ITC Reduction - First Year Bonus Depreciation*

The following table shows the depreciation percentage by year for each depreciation class. For each depreciation class, the percentage is applied to the depreciable basis amount for the given year in the cash flow:

Years 1-10	1	2	3	4	5	6	7	8	9	10
5-yr MACRS	20.0	32.0	19.2	11.5	11.5	5.8				
15-yr MACRS	5.0	9.5	8.6	7.7	6.9	6.2	5.9	5.9	5.9	5.9
5-yr SL	10.0	20.0	20.0	20.0	20.0	10.0				
15-yr SL	3.3	6.7	6.7	6.7	6.7	6.7	6.7	6.7	6.7	6.7
20-yr SL	2.5	5.0	5.0	5.0	5.0	5.0	5.0	5.0	5.0	5.0
39-yr SL	1.3	2.6	2.6	2.6	2.6	2.6	2.6	2.6	2.6	2.6
Years 11-20	11	12	13	14	15	16	17	18	19	20
15-yr MACRS	5.9	5.9	5.9	5.9	5.9	3.0				
15-yr SL	6.7	6.7	6.7	6.7	6.7	3.3				
20-yr SL	5.0	5.0	5.0	5.0	5.0	5.0	5.0	5.0	5.0	5.0
39-yr SL	2.6	2.6	2.6	2.6	2.6	2.6	2.6	2.6	2.6	2.6
Years 21-30	21	22	23	24	25	26	27	28	29	30
20-yr SL	2.5									
39-yr SL	2.6	2.6	2.6	2.6	2.6	2.6	2.6	2.6	2.6	2.6
Years 31-40	31	32	33	34	35	36	37	38	39	40
39-yr SL	2.6	2.6	2.6	2.6	2.6	2.6	2.6	2.6	2.6	1.3

## 35 3D Shade Calculator

The SAM 3D Shade Calculator uses a sun position algorithm and a three-dimensional drawing of a photovoltaic array and nearby shading objects to generate hour-by-month tables of beam irradiance shade loss percentages, and a sky diffuse loss percentage. It has the following features:

- Uses Bing Maps geocoding to automatically find latitude, longitude, and time zone for any street address.
- A three dimensional drawing, or shade scene, represents the photovoltaic array and nearby shading objects.
- The scene consists of active surfaces (photovoltaic subarrays) and shading objects.
- Four three-dimensional shapes are designed to represent most shading objects: Box, cylinder, tree, and roof.
- View and edit the shade scene in three-dimensional, bird's eye, and elevation views.
- Add an optional aerial photograph from Bing Maps or your own image as an underlay for the bird's eye view to help position objects on the scene.
- Drag the three-dimensional view to see shadows on active surfaces and the shade loss at different sun positions.
- Calculate diurnal and hourly beam irradiance shade loss for a single year based on the scene location and relative positions of each active surface and shading objects in the scene.



**To use the SAM shade analysis calculator:**

1. On the [Shading and Layout](#) page (detailed photovoltaic model) or [System Design](#) page (PVWatts), click **Open 3D shade calculator**.
2. [Define the scene location](#) (latitude, longitude, time zone).
3. [Add shading objects](#) to the scene -- these are trees, buildings, and other structures near the array that may block direct solar irradiance from reaching the array.
4. [Add active surface](#) objects to the scene to represent the photovoltaic array or subarrays.
5. [Save and close](#) the calculator to apply shading factor values to the SAM [shading](#) inputs.
6. [Generate shade data](#).
7. [Export shade data](#) to use in SAM or other simulation software.

For more step-by-step instructions, see [How-To](#).

For a description of the 3D shade calculator's features, see [Reference](#).

## 35.1 How-To

The How-To section describes the shade calculator by task:

- [Define the scene location](#)
- [Use an image underlay](#)
- [Add shading objects](#)
- [Add active surface objects](#)
- [Change the view](#)
- [Zoom and pan the scene](#)
- [Select an object](#)
- [Move objects](#)
- [Resize objects](#)
- [Rotate objects](#)
- [Delete and copy objects](#)
- [Change object colors](#)
- [Generate shading data](#)
- [Export shade data](#)

### 35.1.1 Define the scene location

The scene location consists of a latitude, longitude, and time zone. The shade calculator requires this information to calculate sun angles for the shade loss calculations.

When you start the 3D shade calculator from SAM, the location information is automatically populated with values from the [Location and Resource](#) page. If you change the location in SAM, be sure to update the location information in the 3D shade calculator.

You can [underlay an image](#) of the project site, either from Bing maps, or from an image file on your computer.

#### **Define the scene location and time zone**

1. Click **Location**.
2. Type values for **Latitude**, **Longitude**, and **Time zone** by hand,  
or  
type a street address and click **Lookup address** to find the coordinates and time zone automatically. (The calculator uses Google's geocoding API to convert the address to latitude, longitude, and time zone.)

### 35.1.2 Use an image underlay

You can add an optional image underlay to the bird's eye view to help you position objects more accurately. You can either automatically load an aerial photograph of an address from Bing Maps, or load your own image from a different source.

Changing or removing the image underlay does not affect scene objects or the shade analysis -- its only purpose is to give you a visual reference for positioning objects in the scene.

#### **Load an aerial image from Bing Maps**

1. Click **Location**.
2. Type a street address for **Address** and click **Lookup address**,  
or  
type a latitude, longitude, and time zone and click **Update map from coordinates**.  
If an image is available from Bing Maps for that location, the image along with its scale in meters per 100 pixels will appear. (The calculator uses the Bing Maps API for the image because it provides information about the image scale.)

#### **Load an image from another source**

1. [Define the scene location](#).
2. Click **Load image** and open the image file, or click **Paste image** to load an image from your computer's clipboard.
3. Type the image scale. (You can use image editing software to estimate the number of meters per 100 pixels.)

**Set the scale for the image underlay by hand**

1. Click **Manual scale**.
2. Type a value for the number of meters represented by each 100 pixels in the image. The scale bar at the top left corner of the image indicates the length of 100 pixels.

**Use the loaded image as an underlay in the bird's eye view**

1. Load a map image using one of the two methods described above.
2. Click **Underlay this map** in the scene.  
The view will switch to the bird's eye view with the image as an underlay.

**Remove an image underlay**

1. Click **Location**.
2. Click **Remove underlay** in scene.  
The view will switch to the bird's eye view with no underlay. The image remains loaded and available to use until you load a different image.

## 35.1.3 Add shading objects

A shading object is a box, cylinder, roof, round tree, or conical tree shape that represents an object near the photovoltaic array that may shade the array.

The measurements for the size properties of objects (length, width, height, diameter) in the scene can be in any units, as long as you use the same units for all measurements to ensure that the relative size and position of the objects is consistent.

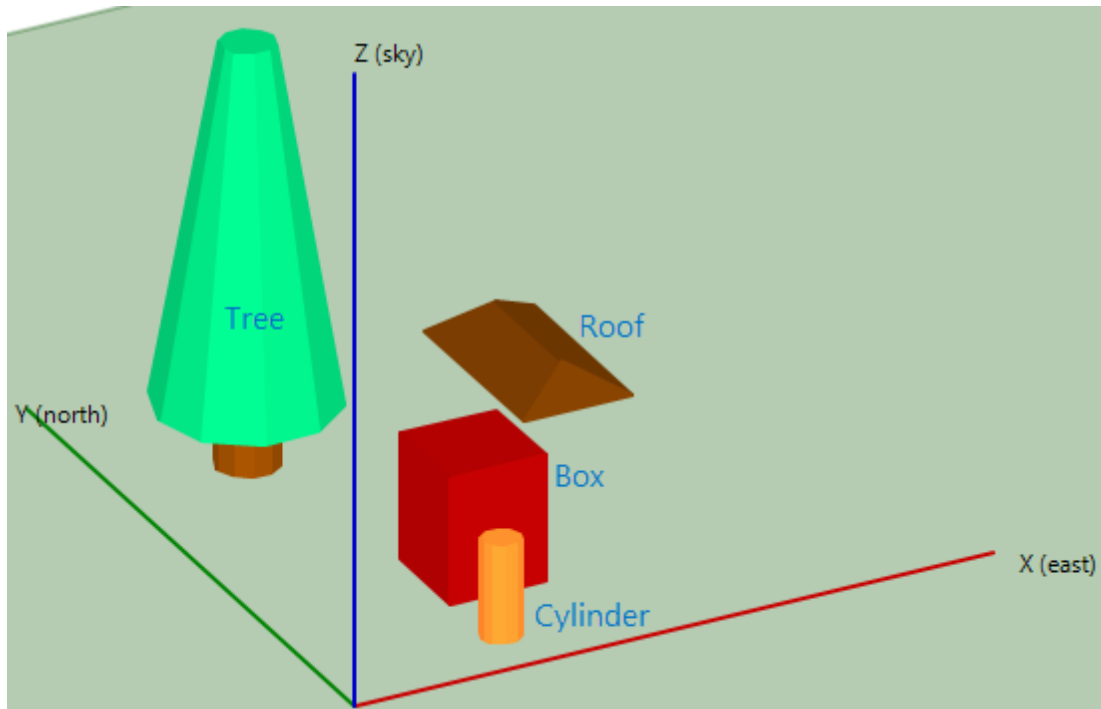
You can add objects to the scene in 3D scene, bird's eye, or elevations view. You can add an aerial photograph as an [underlay](#) to the bird's eye view to help position objects in the scene. You can combine shapes to represent different objects.

- See the [shape reference](#) for a description of the shading object properties.

**To add a shading object to the scene**

1. Click **3D scene**, **Bird's eye**, or **Elevations** to select a view.
2. Click **Create**, and choose a shape from the list.  
The object will appear at the origin of the scene coordinates.
3. [Move and resize the object](#) in bird's eye or elevations view.

Scene Showing the Five Shading Object Shapes



### 35.1.4 Add active surface objects

An [active surface](#) object is a shape that represents the photovoltaic array or subarray. You can add as many active surface objects to the scene as you like.

The measurements for the size properties of objects (length, width, height, diameter) in the scene can be in any units, as long as you use the same units for all measurements to ensure that the relative size and position of the objects is consistent.

An active surface object is the shaded object. When you [generate shade data](#), the shade calculator calculates the fraction (expressed as a percentage) of each active surface that is shaded by the [shading objects](#) and other active surfaces.

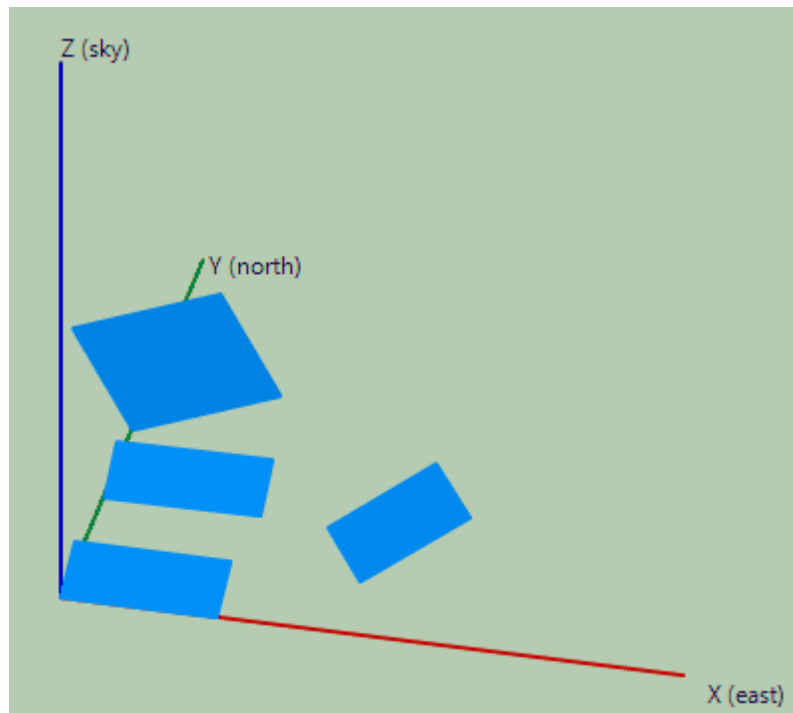
**Note.** The active surface object is intended to represent a small rooftop array or subarray. It is not designed to represent a row in a large roof- or ground-mounted array that consists of many rows of modules.

#### To add an active surface object

1. Click **3D scene**, **Bird's eye**, or **Elevations** to select a view.
2. Click **Create**, and choose **Active Surface** from the list.  
The active surface will appear at the origin of the scene coordinates.
3. [Move and resize the object](#) in bird's eye or elevations view.
4. Type a value for **Tilt** and **Azimuth** in the surface's properties. These correspond to the photovoltaic array's tilt and azimuth values.

5. If your scene has more than one active surface object, and you want to generate separate diurnal shade data tables, assign a different **Group** name to each surface. See [Group](#) for details.

Scene with Four Active Surface Objects



### 35.1.5 Change the view

You can display the scene in three different views:

- **3D scene** shows a three-dimensional representation of the objects in the scene. Use this view to see shadows at different solar azimuth and elevation angles, and to change object position and size using the object properties.
- **Bird's eye** shows the scene as seen from straight above. Use this view to position objects on the ground, and to adjust size and position in the X and Y dimensions (length and width) using either your mouse or the object properties.
- **Elevations** shows the scene as seen from the south. Use this view to adjust size and position in the Z dimension (height) using either your mouse or the object properties.

#### To change the view

- Click **3D scene**, **Bird's eye**, or **Elevations**.

Three Views of the Same Scene



### 35.1.6 Zoom and pan the scene

Use your mouse and keyboard to position the scene in the window.

**Note:** The size of the green rectangle representing the ground and the length of the coordinate axes are arbitrary. You can position objects outside of the zone defined by the axes.

#### To zoom in and out

Zoom in (make scene bigger):

- Press the I key.
- Press and hold the Ctrl key and drag up with your mouse (click and hold the left mouse button).
- Scroll the mouse wheel up.

Zoom out (make scene smaller):

- Press the O key.
- Press and hold the Ctrl key and drag down with your mouse (click hold the left mouse button).
- Scroll the mouse wheel down.

#### To pan the scene

Move the scene up, down, left, or right:

- Press the Left, Right, Up, or Down (arrow) keys.
- Press and hold the Shift key and drag your mouse (click and hold the left mouse button).

#### To center the scene

Move the scene so that the coordinate origin is at the center of the window:

- Press the C key.

## 35.1.7 Select an object

Select an object when you want to move or resize it. Selected objects appear magenta in 3D scene view, and with magenta handles in Bird's eye and Elevations view.

### To select an object

- Click the object,  
or

click the object's name in the object list.

The selected object will be highlighted in the objects list, and will be indicated by a magenta mask or handles, depending on the view. Also, the object's properties appear when it is selected.

If there are multiple objects at your mouse pointer, click once for each object to cycle through the objects.

Selecting an Object

The screenshot illustrates the process of selecting an object in the SAM software. On the left, the object list shows several objects, with 'untitled 5 (Tree, round)' selected and highlighted in blue. A blue text box above the list says 'Click a name in the list to select the object it refers to.' Below the list, a property table is displayed for the selected object. The table has columns for 'Duplicate' and 'Delete', and rows for 'Name', 'X', 'Y', 'Diameter', and 'Height'. The 3D scene view on the right shows a green ground plane, a blue square, and a brown rectangle. A red line labeled 'Z (sky)' is visible. A green octagonal object with two magenta handles is shown in the foreground, with a blue text box below it saying 'Click an object to select it.' Another blue text box above the scene view says 'Magenta handles indicate the selected object.'

Click a name in the list to select the object it refers to.

Magenta handles indicate the selected object.

Click an object to select it.


Duplicate	Delete
	untitled 5
	1.25
	-7.25
	4
	10.25

## 35.1.8 Move objects

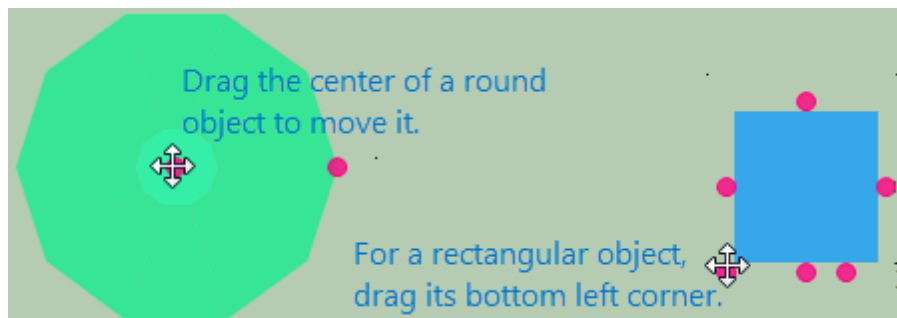
You can move objects by either dragging handles (magenta circles) with your mouse, or typing values for the object properties. You can only use your mouse in Bird's eye and Elevations view. You can edit object properties in any view.

- Use bird's eye view to change an object's horizontal position.
- Use elevations view to change its vertical position.
- Use 3D scene to make adjustments in all three dimensions.

### To move an object with your mouse

1. Click **Bird's eye** to make changes in the X or Y dimension, or click **Elevations** to make changes in the Z dimension.
2. Click the object you want to move. The object's handles will appear to indicate it is selected.
3. Hover over a handle to see the move pointer :  
For rectangular objects, the lower left corner handle moves the object.  
For trees and cylinders, the center handle moves the object.
4. Drag the handle to move the object.  
The object's X and Y coordinate properties change as you drag the object.

#### Moving Round and Rectangular Objects

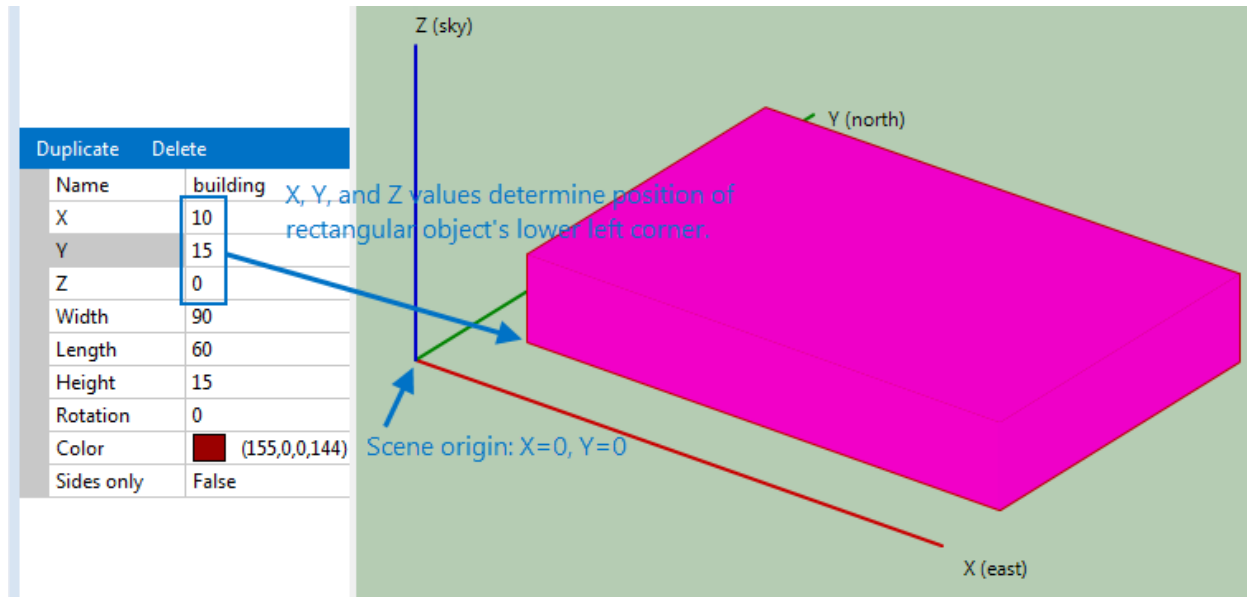


### To move an object by editing its properties

1. Click **3D scene**, **Bird's eye**, or **Elevations**.
2. Click the object you want to move. The object's handles will appear to indicate it is selected, or it will change color in 3D scene view.
3. Type values for the object's X, Y, and Z coordinates (the scene's origin is at the intersection of the X, Y, and Z axes) Be sure to press the Tab or Enter key to store each value:  
For rectangular objects, the coordinates define the position of the corner nearest the origin.  
For objects with a circular projection onto the X-Y plane (trees and cylinders), the coordinates define the position of the center of the circle at the bottom of the cylinder or base of the tree.  
The object moves as you type values.

#### Edit Object Coordinate Properties






### 35.1.9 Resize objects

You can resize objects by either dragging handles (pink circles) with your mouse, or typing values for the object properties. You can only use your mouse in Bird's eye and Elevations view. You can edit object properties in any view.

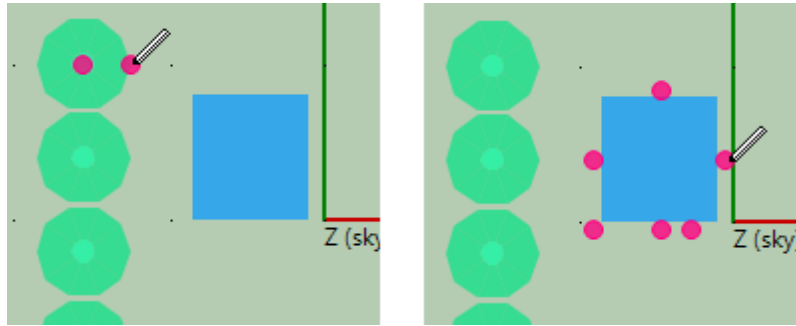
- Use bird's eye view to change lengths, widths, and diameters.
- Use elevations view to change height.
- Use 3D scene to make adjustments in all three dimensions.

The measurements for the size properties of objects (length, width, height, diameter) in the scene can be in any units, as long as you use the same units for all measurements to ensure that the relative size and position of the objects is consistent.

#### To resize an object with your mouse

1. Click **Bird's eye** to make changes in the X or Y dimension, or click Elevations to make changes in the Z dimension.
2. Click the object you want to move. The object's handles will appear to indicate it is selected.
3. Hover over a handle to see the resize pointer  :  
For rectangular objects, the handles at the center of the sides change the length and width.  
For trees and cylinders, the handle at the edges of circles change the diameter. The handles at the top of the tree
4. Drag the handle to resize the object.  
The object's width, length, or diameter change as you drag the handles.

Resizing Objects with the Mouse




### To resize an object by editing its properties

1. Click **3D scene**, **Bird's eye**, or **Elevations**.
2. Click the object you want to move. The object's handles will appear to indicate it is selected, or it will change color in 3D scene view.
3. Type values for the object's width, length, height, or diameter. Be sure to press the Tab or Enter key to store each value.

Note that for rectangular objects, width is in the X direction, and length is in the Y direction.

#### Edit Object Coordinate Properties


Duplicate	Delete
Name	building
X	10
Y	15
Z	0
Width	90
Length	60
Height	15
Rotation	0
Color	 (155,0,144)
Sides only	False

## 35.1.10 Rotate objects

You can rotate rectangular objects in the horizontal plane. In bird's eye view, drag the rotation handle, or in any view change the rotation property.

For active surfaces, the rotation angle is its azimuth angle, with 180 degrees defined as the rotation with the surface's width parallel to the X axis.

**To rotate an object with your mouse.**

1. Click **Bird's eye**.
2. Click the object to select it.
3. Drag the rotation handle .

**To rotate an object by editing its properties**

1. In any view, click the object to select it.
2. Change the value of the rotation property and press the Tab or Enter key.

## 35.1.11 Delete and copy objects

You can delete and copy objects from any view.

**Note.** The SAM shade calculator does not have an Undo feature.

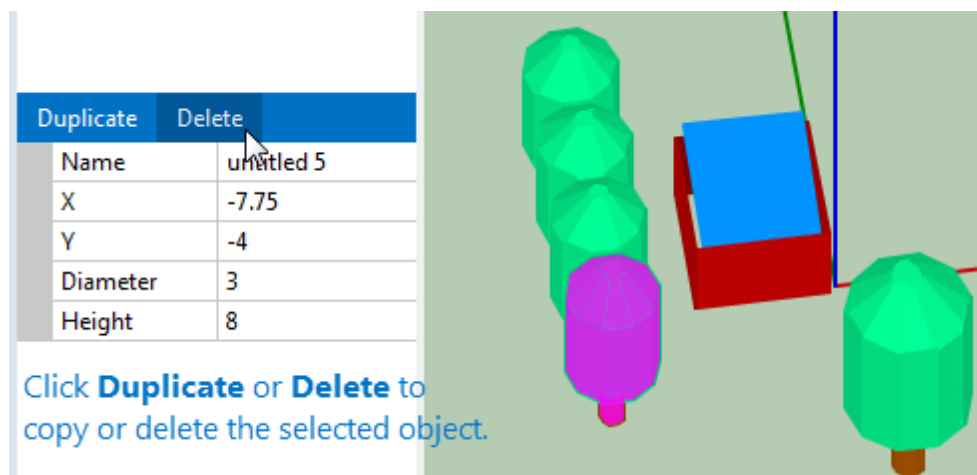
**To delete an object**

1. Click the object to select it.
2. Click **Delete** in the bar above the object's property table.

**To copy an object**

1. Click the object to select it
2. Click **Duplicate** in the bar above the object's property table.

Select an Object to Copy or Delete it.



## 35.1.12 Change object colors

You can change the color of box and roof objects in any view.

### To change an object's color

1. Select the box or roof.
2. In the properties table, type the name of a color, or click the button to choose a color from the Colors window.
3. Press the Enter key.

## 35.1.13 Generate shade data

Once you have created a scene with shading objects and active objects, you can generate tables of shade loss percentages:

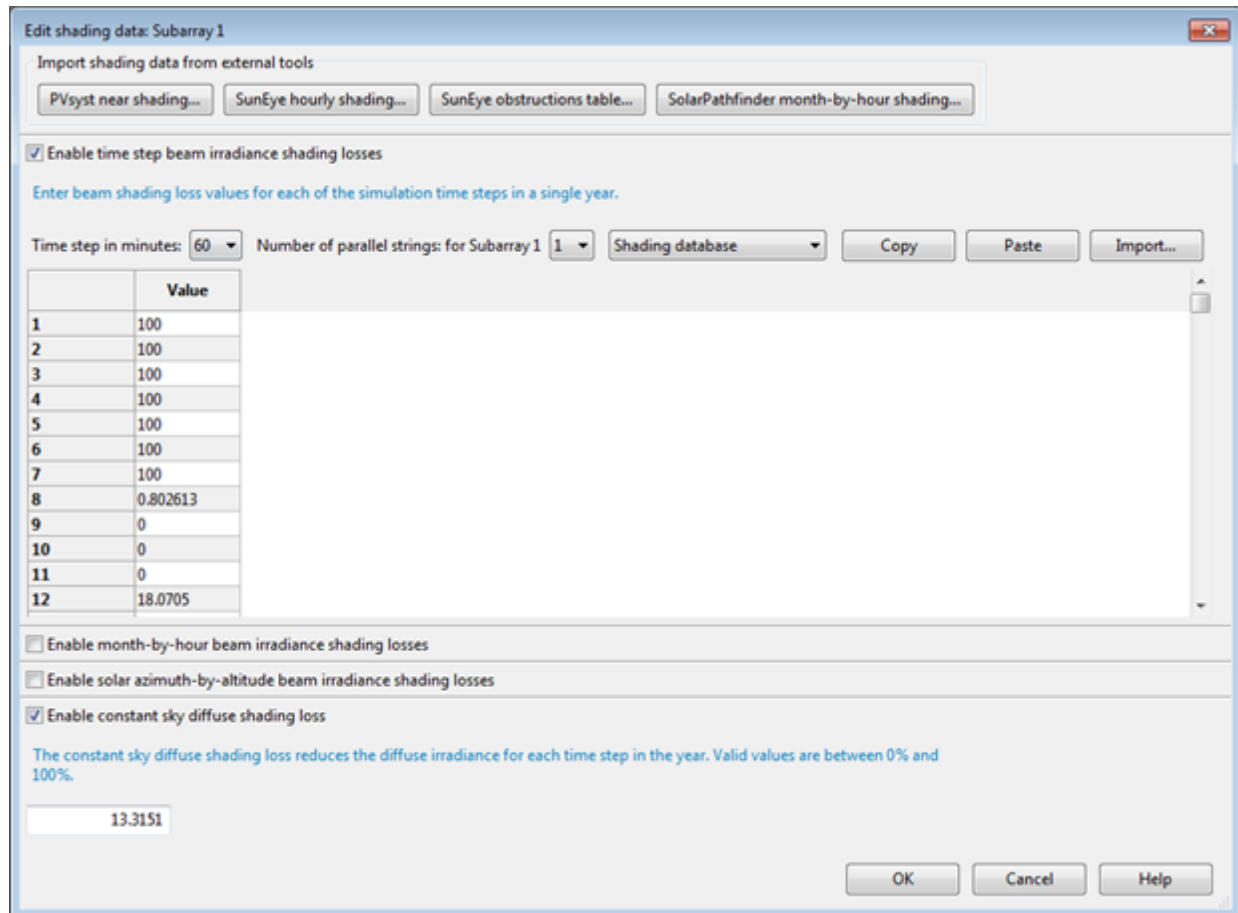
- Diurnal table (24 hour x 12 month) of 288 beam shade loss percentages: Entire array and separate active surfaces.
- Diurnal table (24 hour x 12 month) of 288 beam shade loss percentages: Entire array and separate active surfaces.
- CSV file of time series beam shade loss percentages (8,760 values for hourly simulations).
- A single sky diffuse shade loss percentages.

### **Generating Shade Data to use In SAM**

When you [close](#) the shade calculator, it automatically applies shading losses to SAM's [shading](#) inputs.

### To apply shading data to SAM's shading inputs:

1. Click **Save and Close**.
2. To see the shade data in SAM, on the [Shading](#) page (or [System Design](#) page for PVWatts), click **Edit Shading**. The 3D shade calculator populates the time step beam irradiance shading losses table and assigns a constant sky diffuse shading loss value.



## Generating Shade Data to use Outside of SAM

You can generate diurnal or hourly shade data to either use outside of SAM, or to import into SAM later.

### To generate diurnal shade tables for a single array

1. Click **Location**, and confirm that the [latitude, longitude, and time zone](#) are correct for your scene.
2. Click **3D scene**, and confirm that objects in your scene have the correct size and position.
3. Click **Analyze**.
4. Click **Diurnal analysis**.

A set of 288 beam shade loss values appear in the hour-by-month table.

### To generate hourly shade tables for a single array

1. Click **Location**, and confirm that the [latitude, longitude, and time zone](#) are correct for your scene.
2. Click **3D scene**, and confirm that objects in your scene have the correct size and position.
3. Click **Analyze**.
4. Click **Hourly analysis**.
5. Save the resulting CSV file containing 8,760 hourly shade loss values.

### **To generate diurnal shade tables for multiple active surfaces**

1. Click **Location**, and confirm that the [latitude, longitude, and time zone](#) are correct for your scene.
2. Click **3D scene** or **Bird's eye** to show the scene.
3. For each active surface in the scene:
  - a. Click the surface to select it.
  - b. In the property table, type a name for the **Group** property and press Tab or Enter.  
If you want the calculator to generate a single diurnal shade table for two or more active surfaces, give them each the same group name. See [Group](#) for details.
4. Click **Analyze**.
5. Click **Diurnal analysis**.  
An hour-by-month table appears for each group.

## **35.1.14 Export shade data**

You can export shade data to use outside of SAM, or to use with SAM later.

**Note.** To save your 3D shading scene and automatically [apply shade data to SAM](#) month-by-hour shading factors, click [Save and Close](#).

### **To export diurnal data**

1. Click **Analyze**.
2. [Generate the shade data](#).
3. To export data as a CSV file, click **Export** under the hour-by-month table you want to export, and save the file.
4. To copy the data to your computer's clipboard, click Copy to clipboard. (You can paste the data into a spreadsheet or text file.)

### **To export hourly data**

1. Click **Analyze**.
2. Click **Hourly analysis (entire array)**.

## **35.2 Reference**

This section describes the shade calculator by feature and view:

- [Open and Save](#)
- [Location](#)
- [Create \(Shape Reference\)](#)
- [3D Scene](#)

- [Bird's Eye](#)
- [Elevations](#)
- [Analyze](#)
- [Keyboard Shortcuts](#)
- [File Types](#)

## 35.2.1 Shade data description

The shade loss at a given time is the ratio of the shaded area of the [active surface](#) to its total area expressed as a percentage. The beam shade factor is one minus the shade loss expressed as a fraction.

The shade loss represents a reduction in beam solar irradiance incident on the active surface. The shade loss algorithm does not estimate the reduction in diffuse solar irradiance due to reduction of the view factor caused by shade objects.

If there is more than one active surface in the scene, you can [generate](#) a diurnal table for groups of one or more surfaces, or for groups of active surfaces. You can only generate a single hourly table for the active surfaces combined into a single array -- you cannot generate multiple hourly tables.

The basic shade loss algorithm is:

1. Calculate the sun position given the scene's latitude, longitude, and timezone
  - For the diurnal table, the sun position is at the midpoint of each hour on the 14th day of each month.
  - For the hourly table, the sun position is at the midpoint of each hour of the year.
2. Transform the 3D scene so that the view is aligned to the perspective of the sun.
3. Calculate coordinates of polygons representing the scene.
4. Cull and sort the polygons in order along the vector from the scene to the sun and projected onto a 2D plane. (This step assumes parallel sun rays, so it uses a parallel projection rather than a perspective projection).
5. For each active surface, calculate coordinates of shade polygons, which are polygons that intersect the active surface and shade object polygons.
6. Calculate the shade loss as the ratio of shade polygon area to the active surface area expressed as a percentage.

## 35.2.2 Location

The Location page is where you [define the scene location](#) with an option to [use an image underlay](#).

### Address

The street address for the scene. Uses the Bing Maps API to find an aerial image of the address and assign values to the latitude, longitude, and time zone.

### Latitude

The scene location's latitude north of the equator in decimal degrees.

**Longitude**

The scene location's longitude east of the prime meridian in decimal degrees.

**Time zone**

The scene location's time zone in GMT or UTC.

**Lookup address**

Load an aerial image of the address and assign values to the latitude, longitude, and time zone.

**Update map from coordinates**

Load an aerial image of the latitude and longitude.

**Load image**

Load an image from a file stored on your computer.

**Paste image**

Load an image from your computer's clipboard.

**Manual Scale**

Change the image scale in meters per 100 pixels.

**Zoom and pan tools**

Zoom the image in and out, and pan the image left, right, up, and down.

**Underlay this map in the scene**

Use the map image as an underlay in the bird's eye view. This can be useful for positioning objects in the scene.

**Remove underlay in scene**

Remove the underlay image from the bird's eye view.

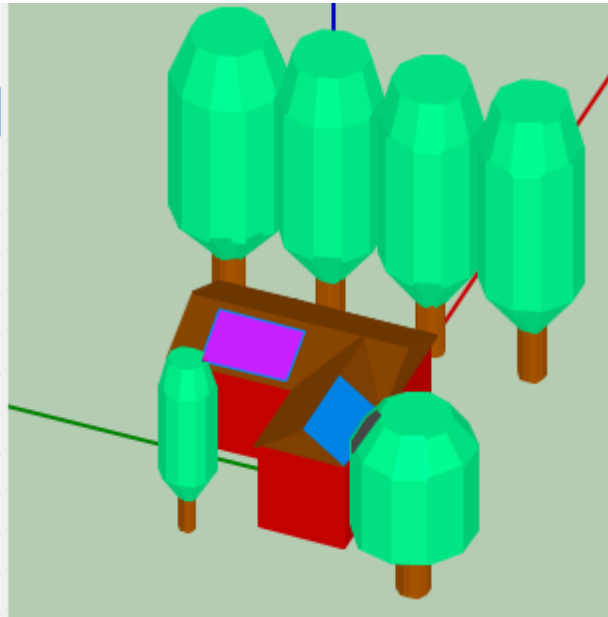
### 35.2.3 Active surfaces

An active surface is a surface that is shaded by the shading objects. For photovoltaic systems, the active surface is the photovoltaic array. Active surfaces can be rectangular or triangular in shape.

A Building with Two Rectangular Active Surfaces in 3D Scene View  
and Properties of the South Facing Surface



Duplicate	Delete
Name	untitled 29
Subarray	2
String	1
Group	
X	1.25
Y	10.75
Z	7.5
Width	6.5
Length	4
Azimuth	270
Tilt	30
Shape	Rectangle

**Name**

Descriptive name for the active surface to help you identify it. Does not affect shade analysis.

**Subarray**

The subarray number (1-4) for the active surface. Each active surface in the shading scene should correspond to a subarray defined on the [System Design](#) page. You can assign more than one active surface to a single subarray.

**String**

The string number (1-8) for the active surface. The 3D shade calculator can generate shade factors for up to eight strings, so the number of strings in parallel on the [System Design](#) page must be 8 or less.

**Notes.**

If your system consists of more than one subarray, define an active surface for each subarray, and use the Subarray property to assign each active surface to a subarray using the subarray number (1-4).

If the subarray consists of more than one electrical string, use the String property name to assign each active surface to a string, and use Subarray property to assign each active surface to a subarray.

**Group**

Descriptive name for a group of active surfaces when the scene has more than one active surface.

**X, Y, Z**

The X, Y, and Z coordinates of the bottom left corner of the active surface.

**Width**

The length of the active surface in the X dimension when the azimuth angle is 180 degrees.

**Length**

The length of the active surface in the Y dimension when the azimuth angle is 180 degrees.

**Note.** The measurements for the size properties of objects (length, width, height, diameter) in the scene can be in any units, as long as you use the same units for all measurements to ensure that the relative size and position of the objects is consistent.

### Azimuth

The angle formed by a line in the X-Y plane perpendicular to the bottom of the array and the X axis. An active surface facing due South has an azimuth angle of 180 degrees.

### Shape

Rectangle or triangle. The triangle shape has a base equal to Width and a height equal to Length.


## 35.2.4 Shading objects

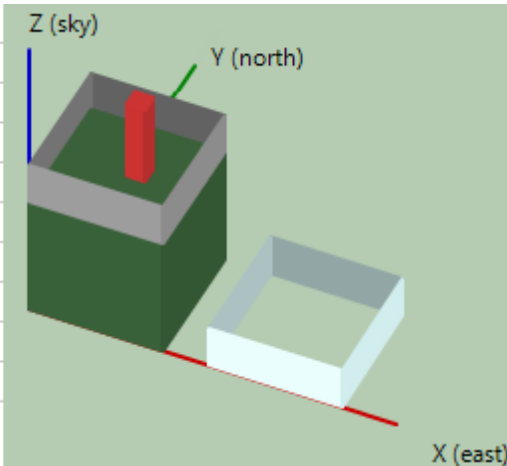
A shading object is a shape in the shading scene that can block sunlight to create a shadow on [active surfaces](#).

### Box

A box shading object is a rectangular solid with either six sides or four sides. Use it to represent buildings, chimneys, parapets, enclosures, and other structures.

Examples of Box Shading Objects with Properties and in 3D Scene View

Name	parapet
X	0
Y	0
Z	15
Width	15
Length	15
Height	5
Rotation	0
Color	 Grey
Sides only	True



### Name

Descriptive name for the box to you identify it. Does not affect shade analysis.

### X, Y, Z

The X, Y, and Z coordinates of the bottom left corner of the box when the rotation angle is zero.

### Width

The length of the side in the X dimension when the rotation angle is zero.

### Length

The length of the side in the Y dimension when the rotation angle is zero.

**Height**

The length of the side in the Z dimension.

**Note.** The measurements for the size properties of objects (length, width, height, diameter) in the scene can be in any units, as long as you use the same units for all measurements to ensure that the relative size and position of the objects is consistent.

**Rotation**

Rotation in the X-Y plane about the origin of the X, Y, and Z axes.

**Color**

Color used to render the box in 3D scene, bird's eye, and elevations view. Does not affect shade analysis. Use different colors when you want to more easily see different boxes in the scene. Type a color name to change the color.

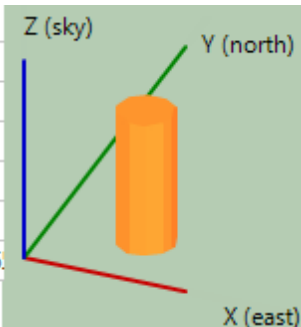

**Sides only**

False is a box with six sides. True is a box with no top or bottom, useful for parapets or wall enclosures.

**Cylinder**

A cylinder shading object is useful for representing poles, chimneys, some kinds of roof protrusions, and other cylindrical objects.

A Cylinder Shading Object in 3D Scene View  
and its Properties

Name	pole	
X	10	
Y	8	
Z	0	
Diameter	6	
Height	15	
Color	 (25)	

**Name**

Descriptive name for the cylinder to you identify it. Does not affect shade analysis.

**X, Y, Z**

The X, Y, and Z coordinates of the center of the base of the cylinder.

**Diameter**

Diameter of the base of the cylinder.


**Color**

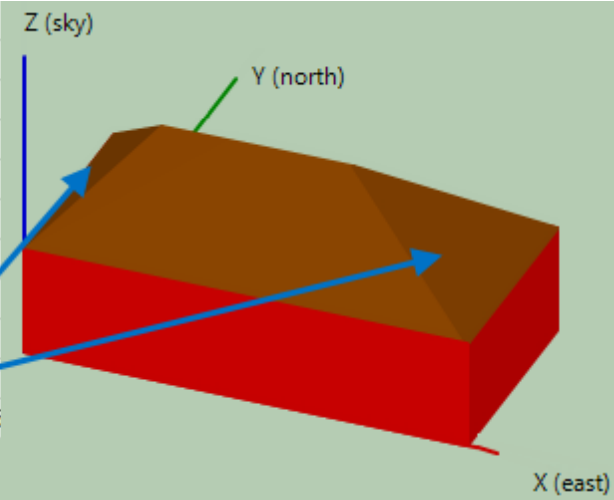
Color used to render the cylinder in 3D scene, bird's eye, and elevations view. Does not affect shade analysis. Type a color name to change the color.

**Roof**

The roof shade object represents a hip or gabled roof.

A Roof Shade Object on a Box in 3D Scene View and its properties

Name	main roof
X	0
Y	24
Z	12
Width	24
Length	48
Height	10
Rotation	270
Pitch Angle 1	45
Pitch Angle 2	30
Color	 (102,5



### Name

Descriptive name for the roof to you identify it. Does not affect shade analysis.

### X, Y, Z

The X, Y, and Z coordinates of the bottom left corner of the roof when the rotation angle is zero.

### Width

The length of the side in the X dimension when the rotation angle is zero.

### Length

The length of the side in the Y dimension when the rotation angle is zero.

### Height

The vertical distance from the base of the roof to its peak.

### Rotation

Rotation in the X-Y plane about the origin of the X, Y, and Z axes.

### Pitch Angles 1 and 2

The angle from the horizontal of the two roof surfaces as shown in the image above. A gable would have a pitch angle of 90 degrees.

### Color

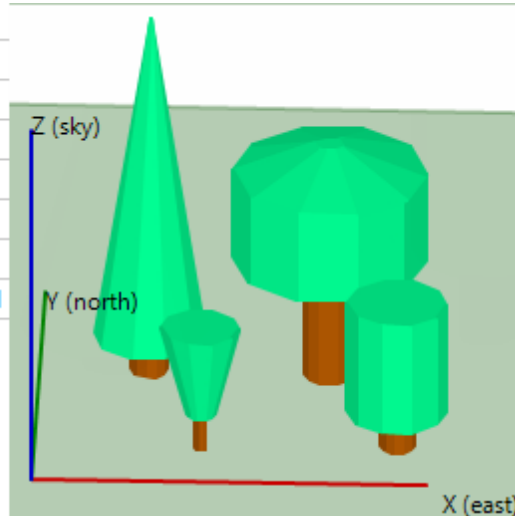
Color used to render the roof in 3D scene, bird's eye, and elevations view. Does not affect shade analysis. Type a color name to change the color.

## Tree

The tree shading object can be used to represent a tree with a variety of crown shapes.

Three Trees in 3D Scene View and the Conical Tree Properties

Name	pine
X	28
Y	60
Diameter	28
Height	100
Top Diameter	0
Trunk Height	10
Shape	Conical

**Name**

Descriptive name for the tree to you identify it. Does not affect shade analysis.

**X, Y**

The X and Y coordinates of the center of the base of the tree.

**Diameter**

For the conical shape, the diameter of the bottom of the tree's crown. For the rounded shape, the diameter of the cylindrical portion of the crown.

**Height**

The distance from the base of the tree trunk to the top of the crown.

**Top Diameter**

The diameter of the top of the tree's crown.

**Trunk Height**

The distance from the base of the tree to the bottom of the crown.

**Shape**

The crown shape. Conical is a versatile shape that you can use for crown shapes like conical, vase, and cylindrical. Rounded is for a crown with a rounded top and bottom.

### 35.2.5 3D scene view

The 3D scene view gives you a three-dimensional representation of the scene. Use it to:

- [Add shading](#) and [active surface](#) objects to the scene.
- [Remove](#) objects from the scene.
- Verify the size and position of objects in the scene.
- [Resize objects](#) by selecting them and changing their properties.

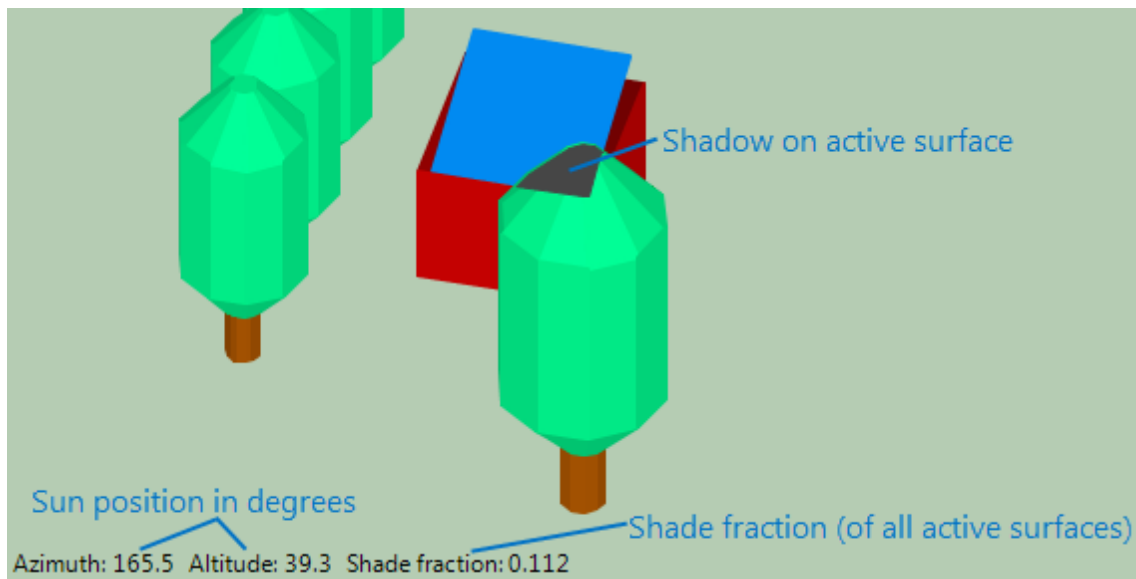
- See shadows on active surfaces and the total shade loss at different sun azimuth and altitude angles.

### To see shadows on active surfaces

1. Click **Location**, and verify that the latitude, longitude, and time zone are correct for your scene.
2. Click **3D Scene view**.
3. Drag (click and hold the left mouse button) the scene to rotate the scene. Your view is the sun's view of the scene (assuming parallel light rays from the sun).

The **Azimuth**, **Altitude**, and **Shade fraction** values change as you rotate the scene, and shaded portions of active surfaces will appear as dark grey polygons.

3D Scene View

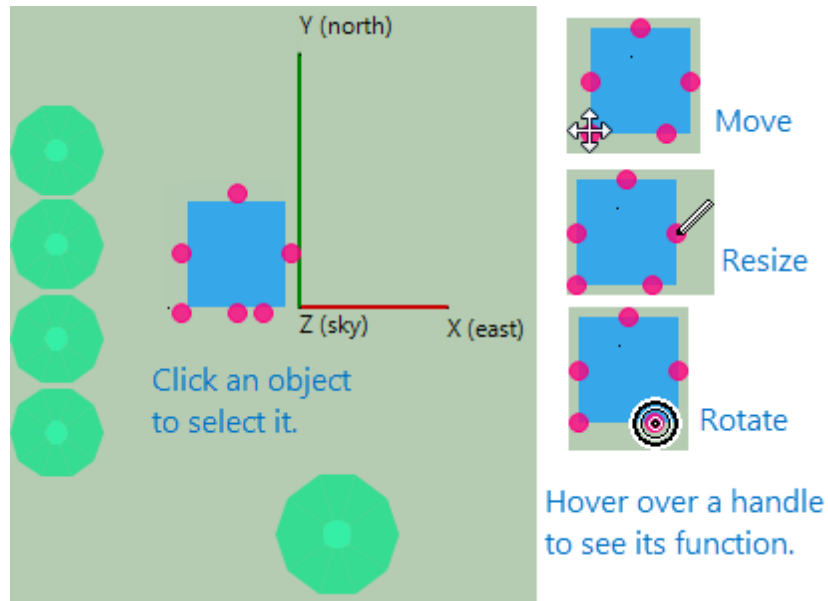


## 35.2.6 Bird's eye view

The bird's eye view gives you an overhead view of the scene and allows you to change object sizes and positions in the X-Y plane. In this view you can:

- [Zoom and pan the scene.](#)
- [Use an image underlay.](#)
- [Move, resize,](#) and [rotate](#) objects in the X-Y plane.
- [Delete and copy objects.](#)
- [Change object colors.](#)

Bird's Eye View Quick Reference

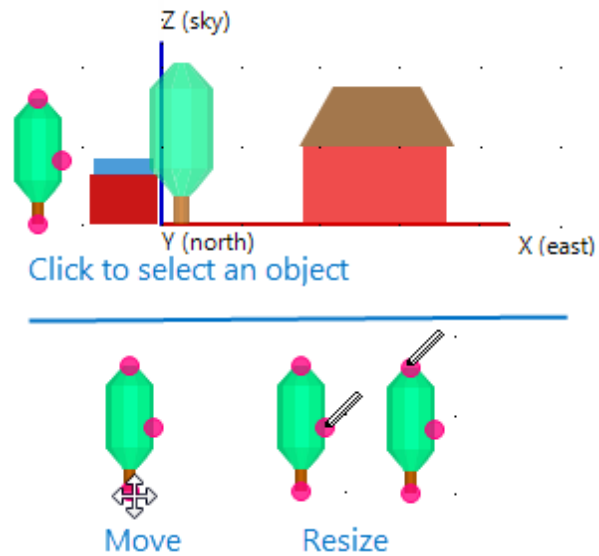


### 35.2.7 Elevations view

The elevations view gives you a view of the scene from the south. In this view you can:

- [Zoom and pan the scene.](#)
- [Use an image underlay.](#)
- [Move](#), [resize](#), and [rotate](#) objects in the X-Z plane.
- [Delete and copy objects.](#)
- [Change object colors.](#)

Elevations View Quick Reference



## 35.2.8 Analyze

Click **Analyze** after creating the shading scene to generate shading data. You can then export shading data for use in simulation models and other software. This section is a quick reference for the Analyze options. For more details see:

- [Generate shade data](#)
- [Export shade data](#)

**Note.** To generate SAM shading inputs, click [Save and Close](#). You do not need to click **Analyze** to generate shading data for SAM.

### Diurnal analysis

Click this button to generate a table of hour-by-month beam shade loss percentages.

When your scene contains more than one active surface, you can generate a separate hour-by-month table for the surfaces by assigning group names to the surfaces. See [Generate shading data for details](#).

### Time series analysis

Generate a CSV file of beam shade loss percentages for each of the time steps in a year.

### Diffuse analysis

Generate a sky diffuse loss percentage.



## 35.2.9 Import and Export

A .s3d file is a binary file that stores information describing the shading scene.

### To import a .s3d file

1. Click **Import** to open the Load Scene from File window.
2. Navigate to the folder and click the file name.

### To export a .s3d file

- Click **Export** to open the Save Scene to File window.

## 35.2.10 Save and Close

Click **Save and Close** to save the 3d shading scene to your SAM file, and optionally [apply the shading factors](#) to the SAM shading inputs.

## 35.2.11 Shortcuts

The following keyboard and mouse shortcuts make it easier to zoom and pan the scene.

**Note.** The scene must have focus for these shortcuts to work. Be sure to click somewhere in the scene before using the shortcuts.

### Open and save files

#### Ctrl-O

open file

#### Ctrl-S

save file

### Zoom and pan the scene

#### Arrow keys (left, right, up, down)

move the scene

#### I

zoom in (make objects bigger)

#### O

zoom out

**C**

center the scene

**Z**

change to elevations view

**T**

change to bird's eye view

**S**

change to 3D scene view

**drag (mouse)**

rotate scene (3D scene view only)

**Shift-drag**

pan scene

**Ctrl-drag**

zoom scene

## 35.2.12 File Types

The shade calculator works with the following types of files:

- Shade scene files, *.s3d*
- Shade scene files are binary files that store information about the objects in the scene.
- comma-separated files, *.csv*
- The calculator exports shade data in text files with comma-separated values.